



**THE DATASHEET OF
5M02659**



KA5x02xx-SERIES

KA5H0265RC, KA5M0265R, KA5L0265R,
KA5H02659RN/KA5M02659RN, KA5H0280R,
KA5M0280R

Fairchild Power Switch(FPS)

Features

- Precision Fixed Operating Frequency (100/67/50kHz)
- Low Start-up Current (Typ. 100uA)
- Pulse by Pulse Current Limiting
- Over Load Protection
- Over Voltage Protection (Min. 25V)
- Internal Thermal Shutdown Function
- Under Voltage Lockout
- Internal High Voltage Sense FET
- Auto-Restart Mode

Description

The Fairchild Power Switch(FPS) product family is specially designed for an off-line SMPS with minimal external components. The Fairchild Power Switch(FPS) consist of high voltage power SenseFET and current mode PWM IC. Included PWM controller features integrated fixed oscillator, under voltage lock out, leading edge blanking, optimized gate turn-on/turn-off driver, thermal shut down protection, over voltage protection, and temperature compensated precision current sources for loop compensation and fault protection circuitry-compared to discrete MOSFET and controller or RCC switching converter solution. The Fairchild Power Switch(FPS) can reduce total component count, design size, weight and at the same time increase efficiency, productivity, and system reliability. It has a basic platform well suited for cost-effective design in either a flyback converter or a forward converter.

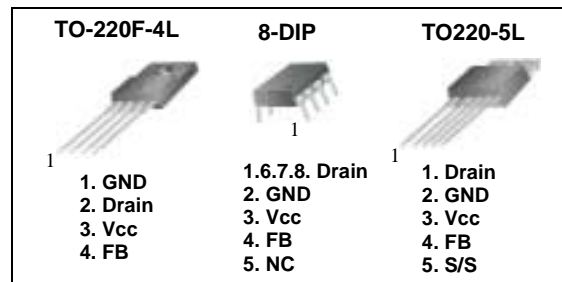

Internal Block Diagram

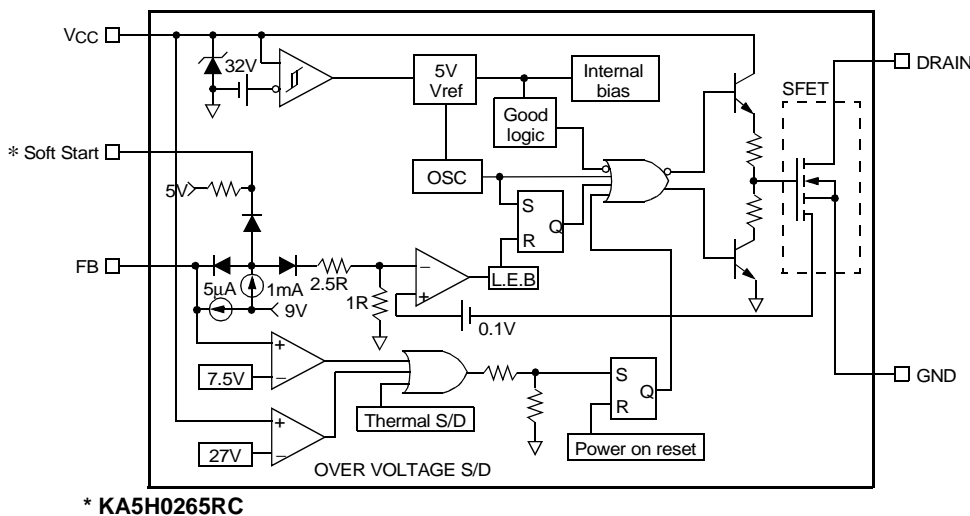

Absolute Maximum Ratings

(Ta=25°C, unless otherwise specified)

Characteristic	Symbol	Value	Unit
KA5x0265xRx			
Drain-Gate Voltage (R _{GS} =1MΩ)	V _{DGR}	650	V
Gate-Source (GND) Voltage	V _{GS}	±30	V
Drain Current Pulsed ⁽¹⁾	I _{DM}	8.0	ADC
Continuous Drain Current (T _C =25°C)	I _D	2.0	ADC
Continuous Drain Current (T _C =100°C)	I _D	1.3	ADC
Single Pulsed Avalanche Energy ⁽²⁾	E _{AS}	68	mJ
Maximum Supply Voltage	V _{CC,MAX}	30	V
Analog Input Voltage Range	V _{FB}	-0.3 to V _{SD}	V
Total Power Dissipation	P _D	42	W
	Darting	0.33	W/°C
Operating Junction Temperature.	T _J	+160	°C
Operating Ambient Temperature.	T _A	-25 to +85	°C
Storage Temperature Range.	T _{STG}	-55 to +150	°C
KA5x0280R			
Drain-Gate Voltage (R _{GS} =1MΩ)	V _{DGR}	800	V
Gate-Source (GND) Voltage	V _{GS}	±30	V
Drain Current Pulsed ⁽¹⁾	I _{DM}	8.0	ADC
Continuous Drain Current (T _C =25°C)	I _D	2.0	ADC
Continuous Drain Current (T _C =100°C)	I _D	1.3	ADC
Single Pulsed Avalanche Energy ⁽²⁾	E _{AS}	90	mJ
Maximum Supply Voltage	V _{CC,MAX}	30	V
Analog Input Voltage Range	V _{FB}	-0.3 to V _{SD}	V
Total Power Dissipation	P _D	35	W
	Darting	0.28	W/°C
Operating Junction Temperature.	T _J	+160	°C
Operating Ambient Temperature.	T _A	-25 to +85	°C
Storage Temperature Range.	T _{STG}	-55 to +150	°C

Note:

1. Repetitive rating: Pulse width limited by maximum junction temperature
2. L = 51mH, starting T_j = 25°C

Electrical Characteristics (SFET Part)

(Ta=25°C unless otherwise specified)

Parameter	Symbol	Condition	Min.	Typ.	Max.	Unit
KA5x0265xRx						
Drain-Source Breakdown Voltage	BV _{DSS}	V _{GS} =0V, I _D =50μA	650	-	-	V
Zero Gate Voltage Drain Current	I _{DSS}	V _{DS} =Max. Rating, V _{GS} =0V	-	-	50	μA
		V _{DS} =0.8Max. Rating, V _{GS} =0V, T _C =125°C	-	-	200	μA
Static Drain-Source on Resistance ^(Note)	R _{DS(ON)}	V _{GS} =10V, I _D =0.5A	-	5.0	6.0	Ω
Forward Transconductance ^(Note)	g _{fs}	V _{DS} =50V, I _D =0.5A	1.5	2.5	-	S
Input Capacitance	C _{iss}	V _{GS} =0V, V _{DS} =25V, f=1MHz	-	550	-	pF
Output Capacitance	C _{oss}		-	38	-	
Reverse Transfer Capacitance	C _{rss}		-	17	-	
Turn on Delay Time	t _{d(on)}	V _{DD} =0.5B V _{DSS} , I _D =1.0A (MOSFET switching time is essentially independent of operating temperature)	-	20	-	nS
Rise Time	t _r		-	15	-	
Turn Off Delay Time	t _{d(off)}		-	55	-	
Fall Time	t _f		-	25	-	
Total Gate Charge (Gate-Source+Gate-Drain)	Q _g	V _{GS} =10V, I _D =1.0A, V _{DS} =0.5B V _{DSS} (MOSFET switching time is essentially independent of operating temperature)	-	-	35	nC
Gate-Source Charge	Q _{gs}		-	3	-	
Gate-Drain (Miller) Charge	Q _{gd}		-	12	-	
KA5x0280R						
Drain-Source Breakdown Voltage	BV _{DSS}	V _{GS} =0V, I _D =50μA	800	-	-	V
Zero Gate Voltage Drain Current	I _{DSS}	V _{DS} =Max. Rating, V _{GS} =0V	-	-	50	μA
		V _{DS} =0.8Max. Rating, V _{GS} =0V, T _C =125°C	-	-	200	μA
Static Drain-Source on Resistance ^(Note)	R _{DS(ON)}	V _{GS} =10V, I _D =0.5A	-	5.6	7.0	Ω
Forward Transconductance ^(Note)	g _{fs}	V _{DS} =50V, I _D =0.5A	1.5	2.5	-	S
Input Capacitance	C _{iss}	V _{GS} =0V, V _{DS} =25V, f=1MHz	-	250	-	pF
Output Capacitance	C _{oss}		-	52	-	
Reverse Transfer Capacitance	C _{rss}		-	25	-	
Turn on Delay Time	t _{d(on)}	V _{DD} =0.5B V _{DSS} , I _D =1.0A (MOSFET switching time is essentially independent of operating temperature)	-	21	-	nS
Rise Time	t _r		-	28	-	
Turn Off Delay Time	t _{d(off)}		-	77	-	
Fall Time	t _f		-	24	-	
Total Gate Charge (Gate-Source+Gate-Drain)	Q _g	V _{GS} =10V, I _D =1.0A, V _{DS} =0.5B V _{DSS} (MOSFET switching time is essentially independent of operating temperature)	-	-	60	nC
Gate-Source Charge	Q _{gs}		-	15	-	
Gate-Drain (Miller) Charge	Q _{gd}		-	20	-	

Note:

1. Pulse test: Pulse width ≤ 300μs, duty cycle ≤ 2%

$$2. S = \frac{1}{R}$$

Electrical Characteristics (Control Part) (Continued)

(Ta=25°C unless otherwise specified)

Parameter	Symbol	Condition	Min.	Typ.	Max.	Unit
UVLO SECTION						
Start Threshold Voltage	V _{START}	V _{FB} =GND	14	15	16	V
Stop Threshold Voltage	V _{STOP}	V _{FB} =GND	8.2	8.8	9.4	V
OSCILLATOR SECTION						
Initial Accuracy	F _{OSC}	KA5H0265xRx KA5H0280R	90	100	110	kHz
Initial Accuracy	F _{OSC}	KA5M0265xRx KA5M0280R	61	67	73	kHz
Initial Accuracy	F _{OSC}	KA5L0265R	45	50	55	kHz
Frequency Change With Temperature ⁽²⁾	ΔF/ΔT	-25°C ≤ Ta ≤ +85°C	-	±5	±10	%
Maximum Duty Cycle	D _{max}	KA5H0265xRx KA5H0280R	62	67	72	%
Maximum Duty Cycle	D _{max}	KA5M0265xRx KA5M0280R KA5L0265R	72	77	82	%
FEEDBACK SECTION						
Feedback Source Current	I _{FB}	Ta=25°C, 0V ≤ V _{fb} ≤ 3V	0.7	0.9	1.1	mA
Shutdown Feedback Voltage	V _{SD}	V _{fb} ≤ 6.5V	6.9	7.5	8.1	V
Shutdown Delay Current	I _{delay}	Ta=25°C, 5V ≤ V _{fb} ≤ V _{SD}	4	5	6	μA
SOFT START SECTION						
Soft Start Voltage	V _{SS}	KA5H0265RC	4.7	5.0	5.3	V
Soft Start Current	I _{SS}		0.8	1.0	1.2	mA
REFERENCE SECTION						
Output Voltage ⁽¹⁾	V _{ref}	Ta=25°C	4.80	5.00	5.20	V
Temperature Stability ⁽¹⁾⁽²⁾	V _{ref} /ΔT	-25°C ≤ Ta ≤ +85°C	-	0.3	0.6	mV/°C
CURRENT LIMIT(SELF-PROTECTION)SECTION						
Peak Current Limit	I _{OVER}	KA5x02659RN	0.79	0.9	1.01	A
Peak Current Limit	I _{OVER}	KA5x0265Rx KA5x0280R	1.05	1.2	1.34	A
PROTECTION SECTION						
Over Voltage Protection	V _{OVP}	V _{CC} ≥ 24V	25	27	29	V
Thermal Shutdown Temperature ⁽¹⁾	T _{SD}	-	140	160	-	°C
TOTAL DEVICE SECTION						
Start-up Current	I _{START}	V _{CC} =14V	-	100	170	μA
Operating Supply Current (Control Part Only)	I _{OPR}	V _{CC} ≤ 28	-	7	12	mA

Note:

1. These parameters, although guaranteed, are not 100% tested in production
2. These parameters, although guaranteed, are tested in EDS (wafer test) process

Typical Performance Characteristics

(These characteristic graphs are normalized at $T_a=25^\circ\text{C}$)

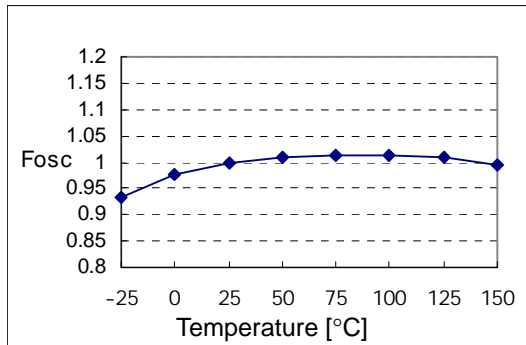

Figure 1. Operating Frequency

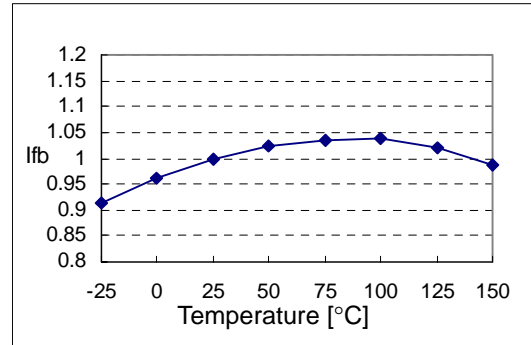

Figure 2. Feedback Source Current

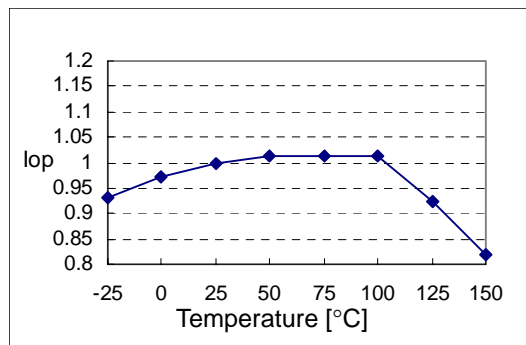

Figure 3. Operating Supply Current

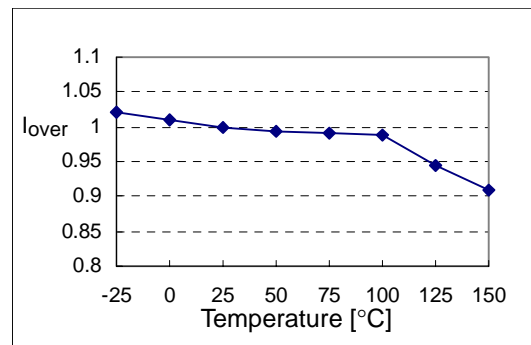

Figure 4. Peak Current Limit

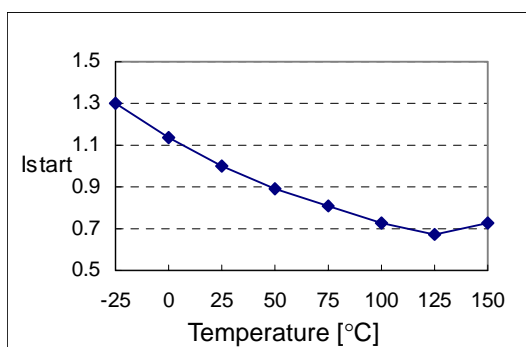

Figure 5. Start up Current

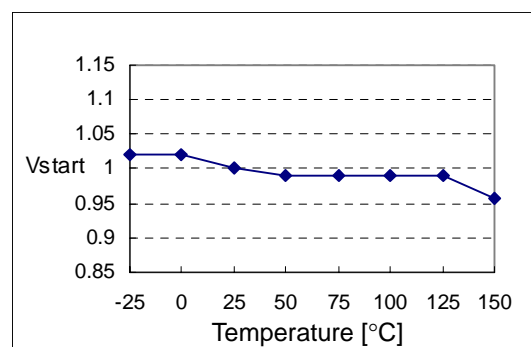

Figure 6. Start Threshold Voltage

Typical Performance Characteristics (Continued)

(These characteristic graphs are normalized at $T_a=25^\circ\text{C}$)

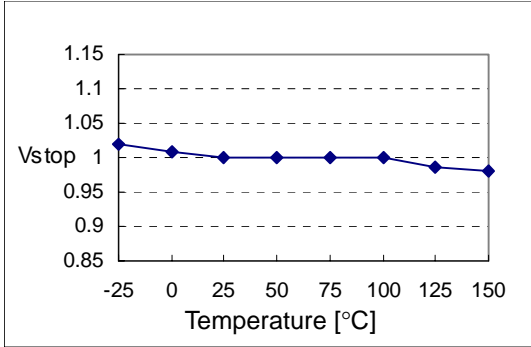

Figure 7. Stop Threshold Voltage

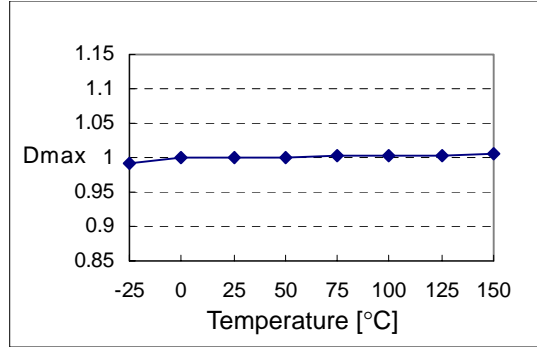

Figure 8. Maximum Duty Cycle

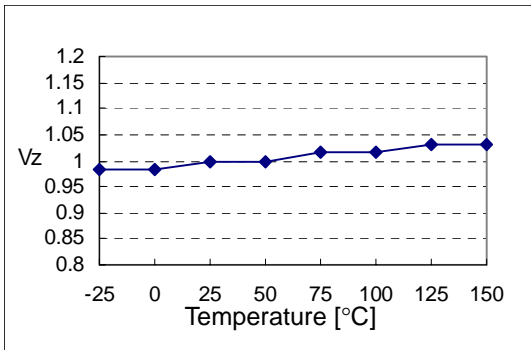

Figure 9. VCC Zener Voltage

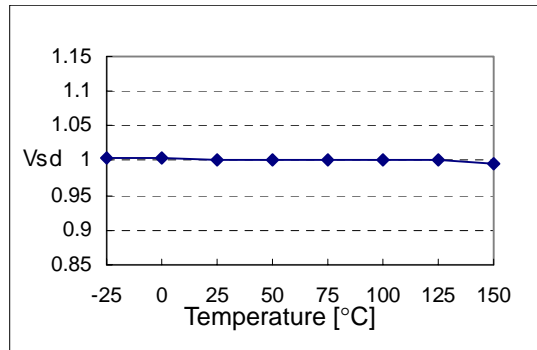

Figure 10. Shutdown Feedback Voltage

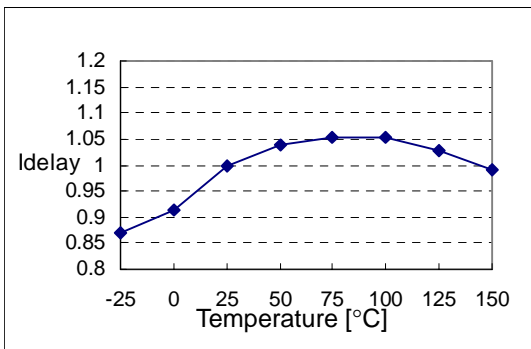

Figure 11. Shutdown Delay Current

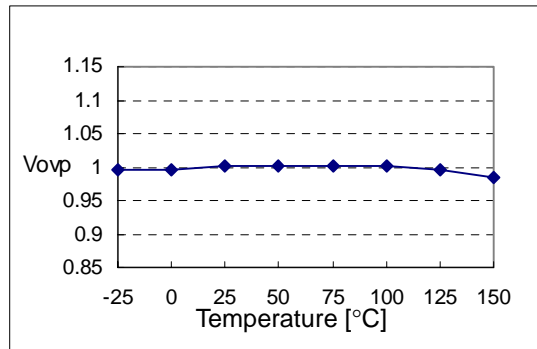

Figure 12. Over Voltage Protection

Typical Performance Characteristics (Continued)

(These characteristic graphs are normalized at Ta=25°C)

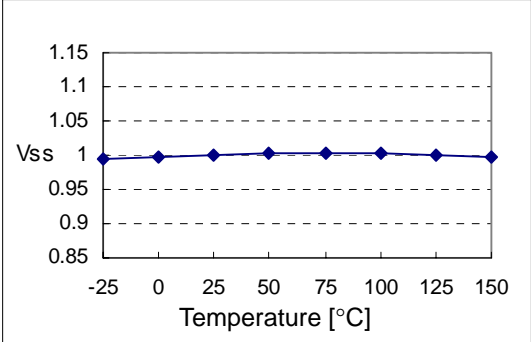

Figure13. Soft Start Voltage

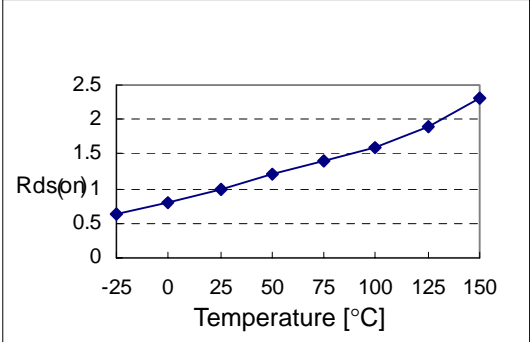
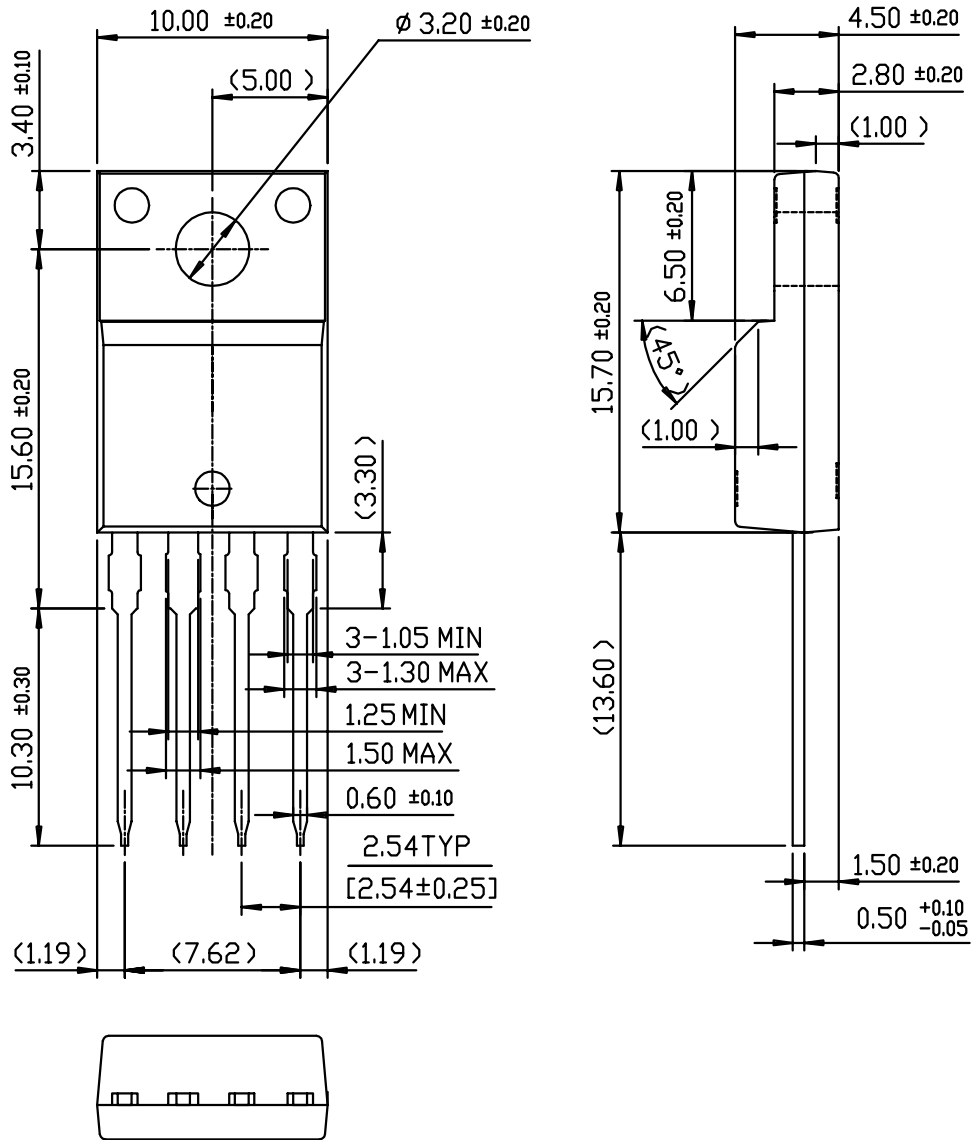

Figure 14. Static Drain-Source on Resistance

Package Dimensions

TO-220F-4L



Package Dimensions (Continued)

8-DIP

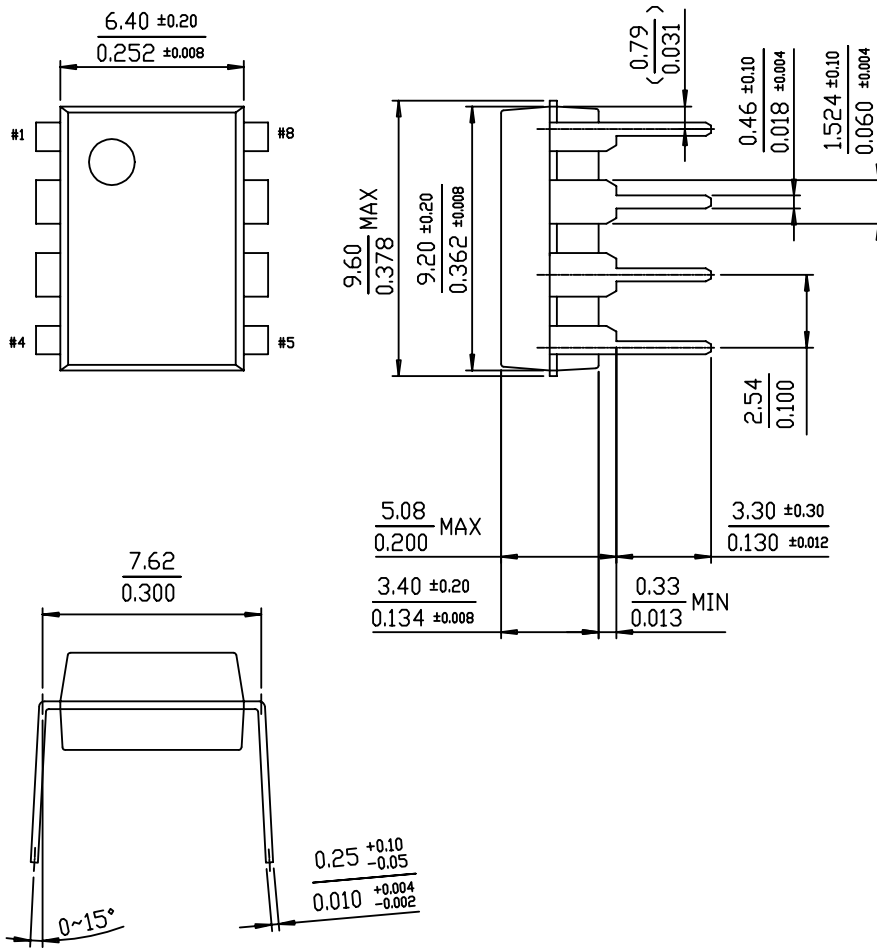

Package Dimensions (Continued)

TO-220-5L

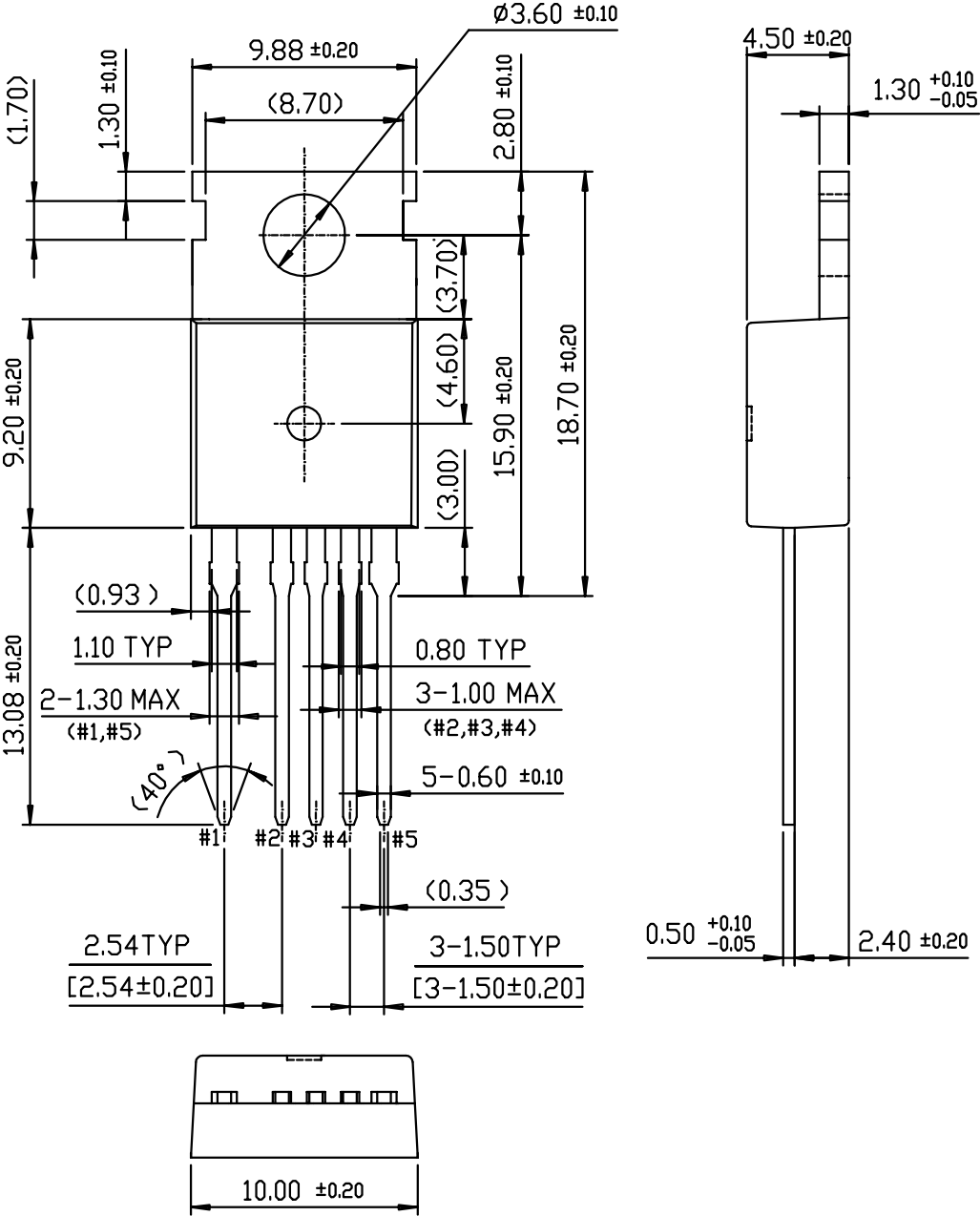

Package Dimensions (Continued)

TO-220-5L(Forming)

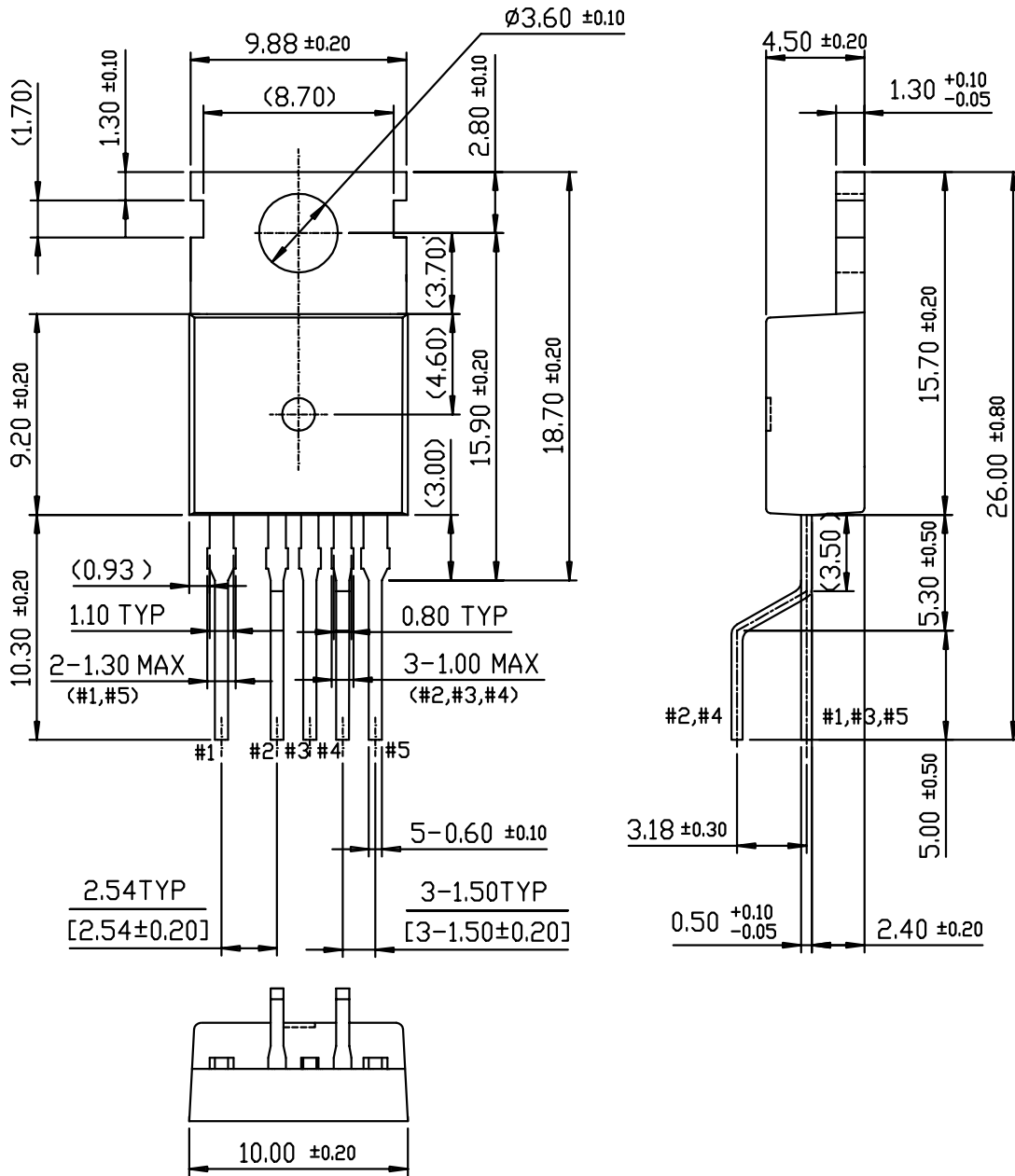

Ordering Information

Product Number	Package	Marking Code	BVDSS	FOSC	RDS(on)
KA5H0265RCTU	TO-220-5L	5H0265RC	650V	100kHz	5Ω
KA5H0265RCYDTU	TO-220-5L(Forming)				
KA5M0265RTU	TO-220F-4L	5M0265R	650V	67kHz	5Ω
KA5M0265RYDTU	TO-220F-4L(Forming)				
KA5L0265RTU	TO-220F-4L	5L0265R	650V	50kHz	5Ω
KA5L0265RYDTU	TO-220F-4L(Forming)				
Product Number	Package	Marking Code	BVDSS	FOSC	RDS(on)
KA5H0280RTU	TO-220F-4L	5H0280R	800V	100kHz	5.6Ω
KA5H0280RYDTU	TO-220F-4L(Forming)				
KA5M0280RTU	TO-220F-4L	5M0280R	800V	67kHz	5.6Ω
KA5M0280RYDTU	TO-220F-4L(Forming)				
Product Number	Package	Marking Code	BVDSS	FOSC	RDS(on)
KA5H02659RN	8-DIP	5H02659R	650V	100kHz	5Ω
KA5M02659RN	8-DIP	5M02659R	650V	67kHz	5Ω

TU : Non Forming Type

YDTU : Forming Type

DISCLAIMER

FAIRCHILD SEMICONDUCTOR RESERVES THE RIGHT TO MAKE CHANGES WITHOUT FURTHER NOTICE TO ANY PRODUCTS HEREIN TO IMPROVE RELIABILITY, FUNCTION OR DESIGN. FAIRCHILD DOES NOT ASSUME ANY LIABILITY ARISING OUT OF THE APPLICATION OR USE OF ANY PRODUCT OR CIRCUIT DESCRIBED HEREIN; NEITHER DOES IT CONVEY ANY LICENSE UNDER ITS PATENT RIGHTS, NOR THE RIGHTS OF OTHERS.



LIFE SUPPORT POLICY

FAIRCHILD'S PRODUCTS ARE NOT AUTHORIZED FOR USE AS CRITICAL COMPONENTS IN LIFE SUPPORT DEVICES OR SYSTEMS WITHOUT THE EXPRESS WRITTEN APPROVAL OF THE PRESIDENT OF FAIRCHILD SEMICONDUCTOR CORPORATION. As used herein:

1. Life support devices or systems are devices or systems which, (a) are intended for surgical implant into the body, or (b) support or sustain life, and (c) whose failure to perform when properly used in accordance with instructions for use provided in the labeling, can be reasonably expected to result in a significant injury of the user.
2. A critical component in any component of a life support device or system whose failure to perform can be reasonably expected to cause the failure of the life support device or system, or to affect its safety or effectiveness.

Looking for pricing, stock, or lifecycle information?

Click below to explore more details on WIN SOURCE:

-  [View 5M02659 on WIN SOURCE](#)
-  [Fairchild/ON Semiconductor Information](#)

Optimize Your Supply Chain with WIN SOURCE Solutions

-  Global Sourcing Solution
-  Obsolete Management
-  Cost Control Management
-  Shortage Management
-  Alternative Solution
-  Excess Inventory Management