



**THE DATASHEET OF
RN112-0.6/02**



GENERAL DESCRIPTION

The SP34063A is a monolithic switching regulator control circuit containing the primary functions required for DC-DC converters.

This device consists of an internal temperature compensated reference, voltage comparator, controlled duty cycle oscillator with active current limit circuit, driver and high current output switch. This device was specifically designed to be used in buck, boost, and Voltage-Inverting applications with a minimum number of external components.

The SP34063A is available in the 8 pin NSOIC package.

APPLICATIONS

- Battery Charger Circuit
- NICs/Switches/Hubs
- ADSL Modems
- Negative Voltage Power Supply

FEATURES

- Supply Voltage: 3V - 36V
- Current Limiting
- Output Switch Current to 1.5A
- Adjustable Output Voltage
- Operation frequency up to 180KHz
- Low Quiescent Current
- Precision 2% Reference
- Available in 8 pin NSOIC Package

TYPICAL APPLICATION DIAGRAM

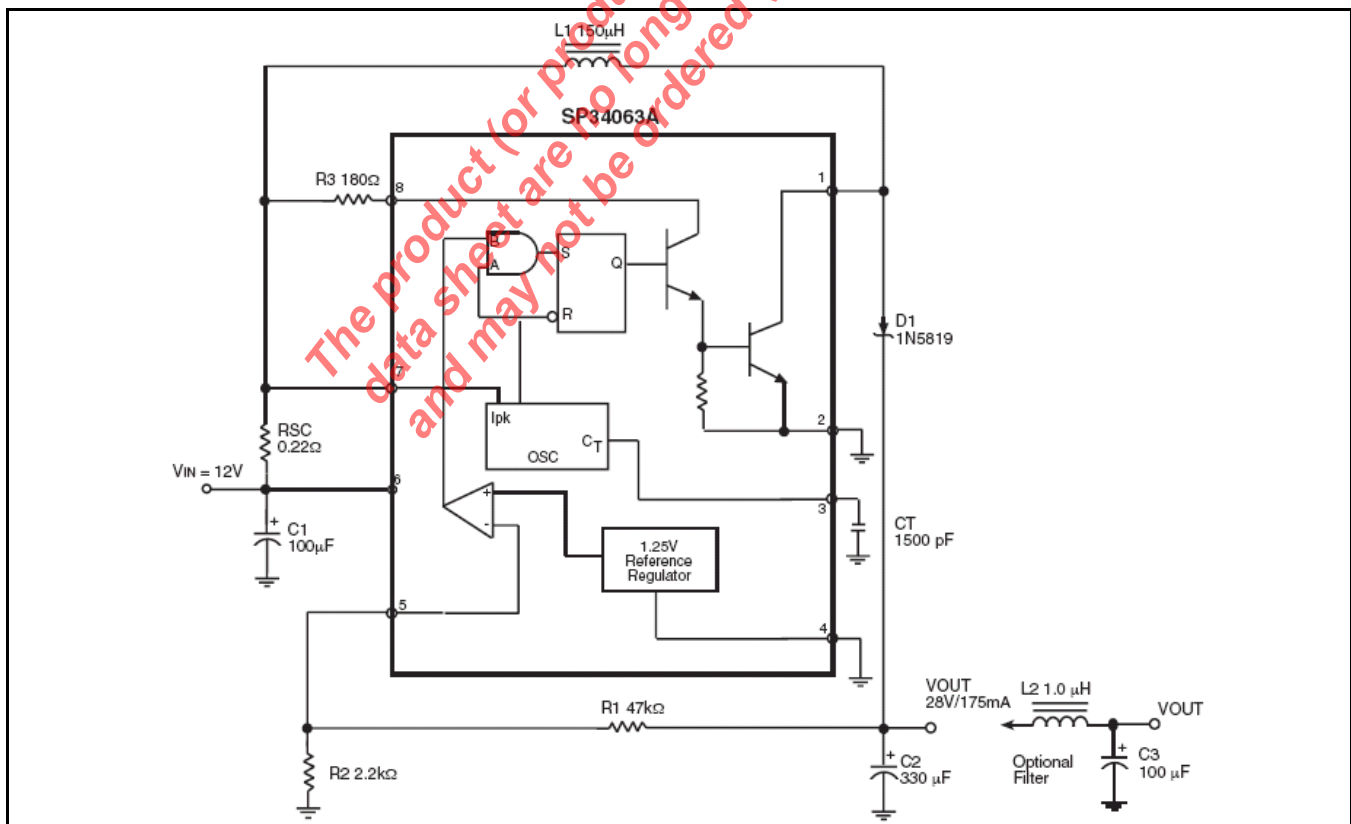

Fig. 1: SP34063A Application Diagram



1.5A Buck/Boost/Inverting DC-DC Regulator

ABSOLUTE MAXIMUM RATINGS

These are stress ratings only and functional operation of the device at these ratings or any other above those indicated in the operation sections of the specifications below is not implied. Exposure to absolute maximum rating conditions for extended periods of time may affect reliability.

Power Supply Voltage V_{CC} 40V
 Comparator Input Voltage -0.3V to 40V
 Switch Collector Voltage 40V
 Switch Emitter Voltage ($V_{PIN1}=40V$) 40V
 Switch Collector to Emitter Voltage 40V
 Driver Collector Voltage 40V
 Driver Collector Current (Note 2) 100mA
 Switch Current 1.5A
 Storage Temperature -65°C to 150°C
 ESD Rating (HBM - Human Body Model) 2kV

OPERATING RATINGS

Input Voltage Range V_{IN} 3.0V to 36V
 Power Dissipation ($T_A=25^\circ C$ - NSOIC) 780mW
 Junction Temperature Range -40°C to 150°C
 Thermal Resistance θ_{JA} 160°C/W

ELECTRICAL SPECIFICATIONS

Specifications with standard type are for an Operating Temperature of $T_A = 25^\circ C$ only. Minimum and Maximum limits are guaranteed through test, design, or statistical correlation. Typical values represent the most likely parametric norm at $T_A = 25^\circ C$, and are provided for reference purposes only. Unless otherwise indicated, $V_{CC} = 5.0V$, $T_A = -40^\circ C$ to $85^\circ C$.

Parameter	Min.	Typ.	Max.	Units	Conditions
Oscillator					
Frequency F_{OSC}	30	38	45	KHz	$V_{PIN5} = 0V$, $CT = 1.0nF$, $T_A = 25^\circ C$
Charge Current I_{CHG}	30	38	45	μA	$V_{CC} = 5.0V$ to $36V$, $T_A = 25^\circ C$
Discharge Current I_{DISCHG}	180	240	290	μA	$V_{CC} = 5.0V$ to $36V$, $T_A = 25^\circ C$
Discharge to Charge Current Ration I_{DISCHG}/I_{CHG}	5.2	6.5	7.5		Pin 7 to V_{CC} , $T_A = 25^\circ C$
Current Limit Sense Voltage $V_{IPK(sense)}$	250	300	350	mV	$I_{DISCHG} = I_{CHG}$, $T_A = 25^\circ C$
Output Switch (Note 1)					
Saturation Voltage, Darlington Connection $V_{CE(sat)}$		1.0	1.3	V	$I_{SW}=1A$, pin1,8 connected
Saturation Voltage (note 2)		0.45	0.7	V	$I_{SW}=1A$, R pin8 = 82ohms to V_{CC} , forced $\beta=20$
DC Current Gain	50	75			$I_{SW}=1A$, $V_{CE} = 5V$, $T_A = 25^\circ C$
Collector Off-State Current		0.01	100	μA	$V_{CE}=36V$
Comparator					
Threshold Voltage V_{TH}	1.225	1.250	1.275	V	$T_A = 25^\circ C$
	1.210	1.250	1.290	V	$T_A = -40^\circ C$ to $85^\circ C$
Threshold Voltage Line Regulation R_{EGLINE}		1.4	5	mV	$V_{CC} = 3.0V$ to $36V$
Input Bias Current I_{IB}		-20	-400	nA	$V_{IN}= 0V$
Total Device					
Supply Current I_{CC}			4	mA	$V_{CC}=5.0V$ to $36V$, $CT=1nF$, pin 7 = V_{CC} $V_{pin5} > V_{TH}$

Note 1: Low duty cycle pulse techniques are used during the test program to maintain junction temperature as close to ambient temperature as possible.

Note 2: If the output switch is driven into hard saturation (non-Darlington configuration) at low switch currents ($\leq 300mA$) and high driver currents ($\geq 30mA$), it may take up to 2.0 μs for it to come out of saturation. This condition will shorten the

1.5A Buck/Boost/Inverting DC-DC Regulator

off time at frequencies above 30KHz, and is magnified at high temperatures. This condition does not occur with a Darlington configuration, since the output switch cannot saturate. If a non-Darlington configuration is used, the following output drive condition is recommended.

$$\text{Forced } \beta \text{ of output switch} = \frac{I_C \text{ Output}}{I_C \text{ Driver} - 7\text{mA}^*} \geq 10$$

* The 100Ω resistor in the emitter of the driver device requires about 7.0mA before the output switch conducts.

BLOCK DIAGRAM

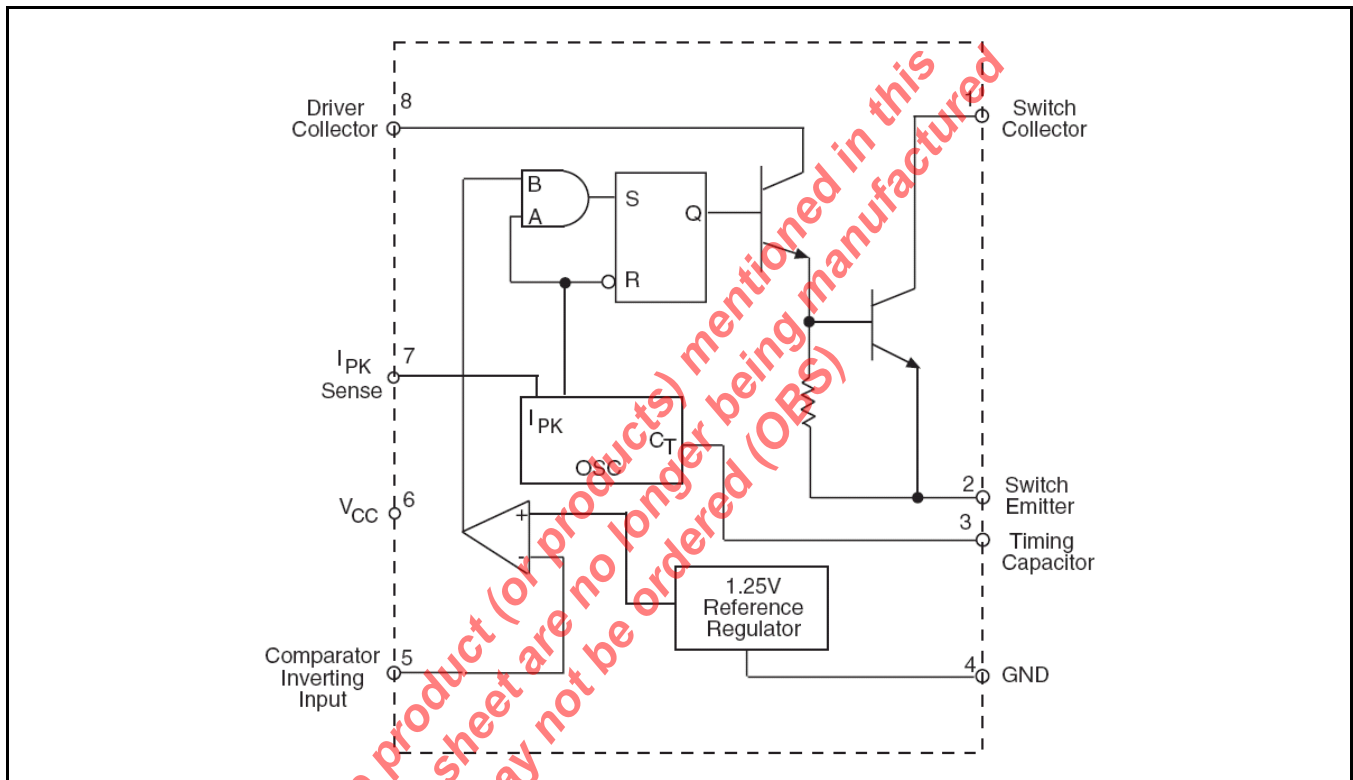

Fig. 2: SP34063A Block Diagram

PIN ASSIGNMENT

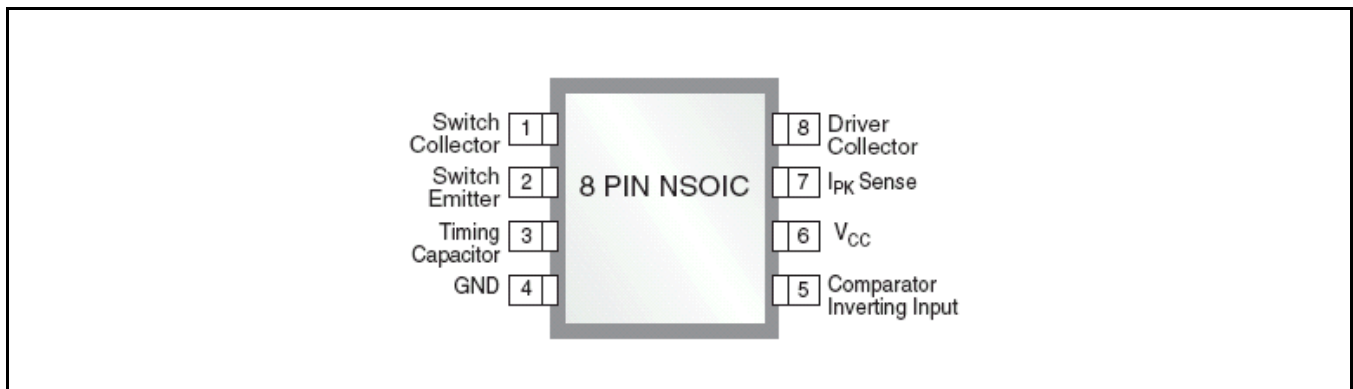

Fig. 3: SP34063A Pin Assignment

PIN DESCRIPTION

Name	Pin Number	Description
Switch Collector	1	Internal switch transistor collector
Switch Emitter	2	Internal switch transistor emitter
Timing Capacitor	3	Timing capacitor to control the switching frequency
GND	4	Ground pin for all internal circuit
Comparator Inverting Input	5	Inverting input pin for internal comparator
V _{CC}	6	Voltage supply
I _{PK} Sense	7	Peak Current Sense Input by monitoring the voltage drop across an external I sense resistor to limit the peak current through the switch
Driver Collector	8	Voltage driver collector

ORDERING INFORMATION

Part Number	Temperature Range	Package	Packing Quantity	Note 1	Note 2
SP34063AEN-L	-40°C ≤ T _A ≤ +85°C	NSOIC-8	Bulk	Lead Free	
SP34063AEN-L/TR	-40°C ≤ T _A ≤ +85°C	NSOIC-8	2.5K/Tape & Reel	Lead Free	

The product (or products) mentioned in this data sheet are no longer being manufactured and may not be ordered (P.O.S)

TYPICAL PERFORMANCE CHARACTERISTICS

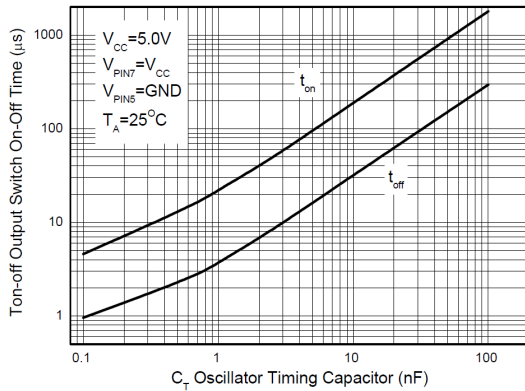

Fig. 4: Output Switch On-Off Time vs. Oscillator Timing Capacitor

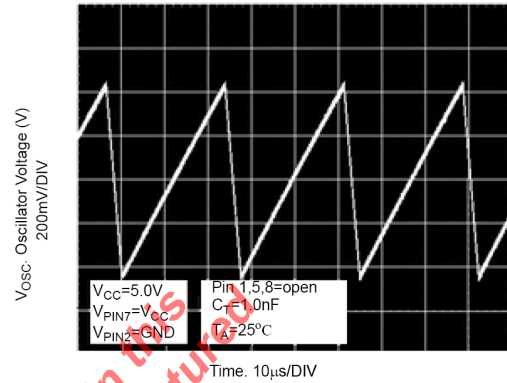

Fig. 5: Timing Capacitor Waveform

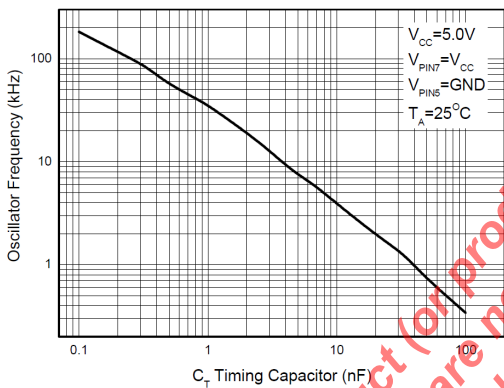

Fig. 6: Oscillator Frequency vs. Timing Capacitor

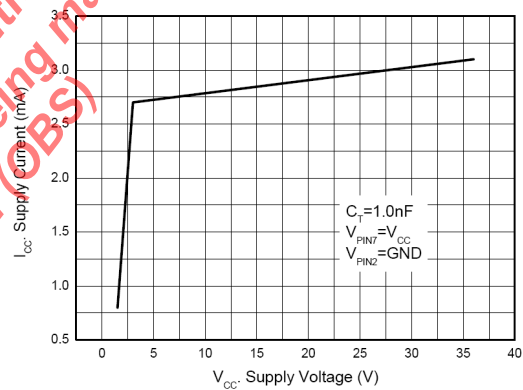

Fig. 7: Standard Supply Current vs. Supply Voltage

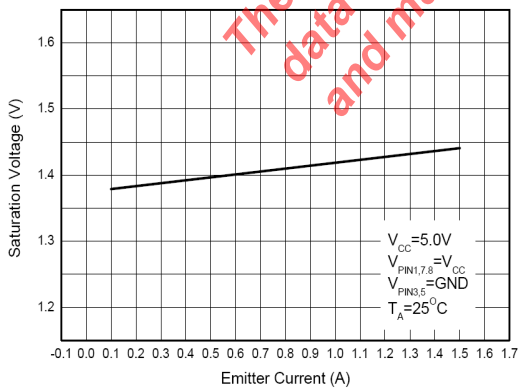

Fig. 8: Emitter Follower Configuration Output Switch Saturation vs. Emitter Current

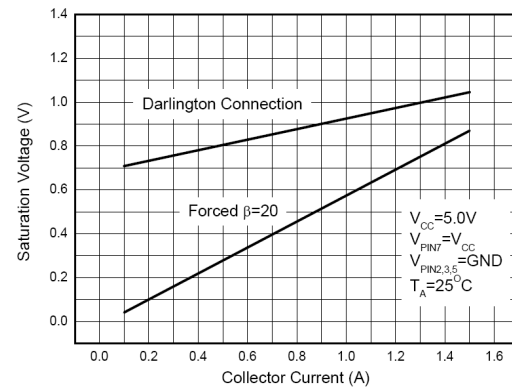

Fig. 9: Common Emitter Configuration Output Switch Saturation vs. Collector Current

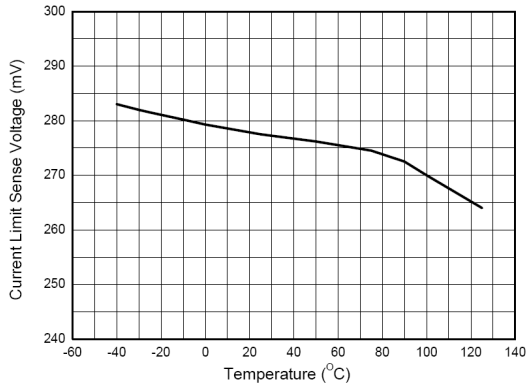
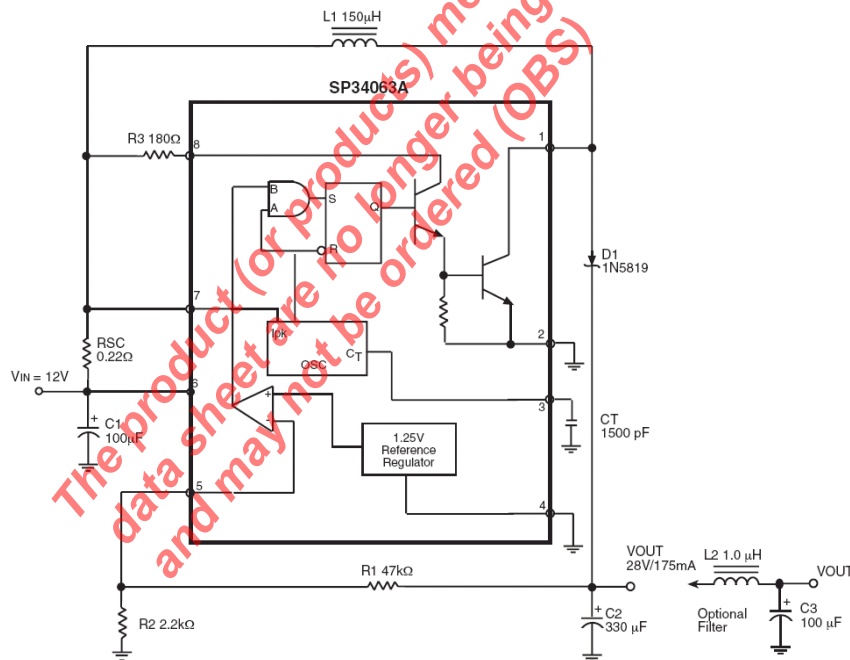

Fig. 10: Current Limit Sense Voltage vs. Temperature

APPLICATION INFORMATION

TYPICAL BOOST CONVERTER CIRCUIT



This is a typical boost converter configuration. In the steady state, if the resistor divider voltage at pin 5 is greater than the voltage in the non-inverting input, which is 1.25V determined by the internal reference, the output of the comparator will go low. At the next switching period, the output switch will not conduct and the output voltage will eventually drop below its nominal voltage until the divider voltage at pin 5 is lower than 1.25. Then the output of the comparator will go high, the output switch will be allowed to conduct. Since $V_{PIN5} = V_{OUT} \cdot R2 / (R1 + R2) = 1.25(V)$, The output voltage can be decided by $V_{OUT} = 1.25V \cdot (R1 + R2) / R2(V)$.

TYPICAL BUCK CONVERTER CIRCUIT

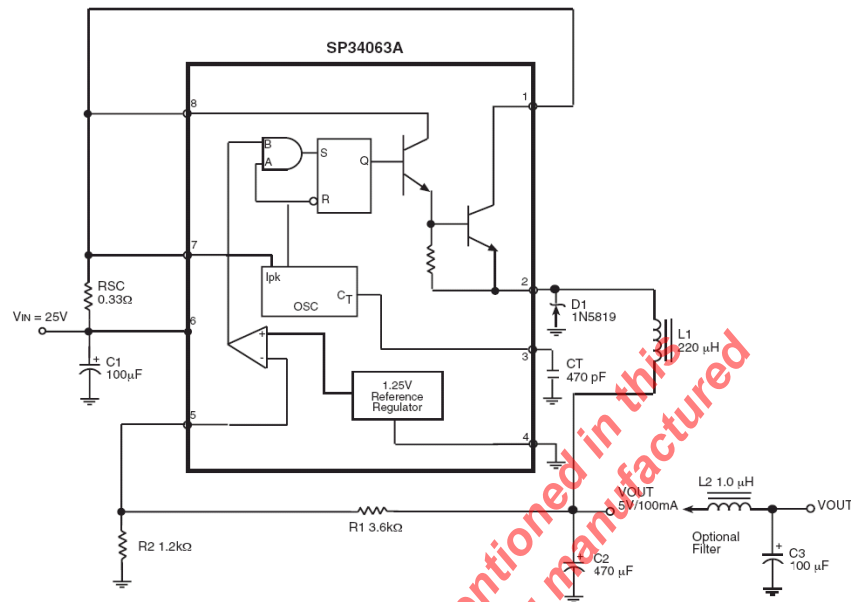

This is a typical buck converter configuration. The working process in the steady state is similar to a boost converter, $V_{PIN5} = V_{OUT} * R2 / (R1 + R2) = 1.25(V)$. The output voltage can be decided by $V_{OUT} = 1.25V * (R1 + R2) / R2(V)$.

TYPICAL INVERTING CONVERTER CIRCUIT

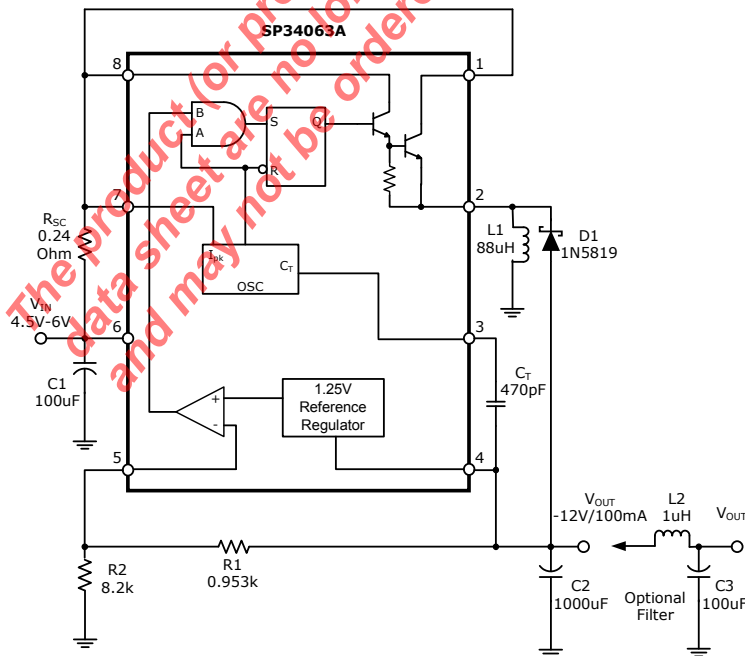

This is a typical boost converter configuration. The working process in the steady state is similar to a boost converter, the difference in this situation is that the voltage at the non-inverting pin of the comparator is equal to $1.25V + V_{OUT}$, then $V_{PIN5} = V_{OUT} * R2 / (R1 + R2) = 1.25V, + V_{OUT}$. The output voltage can be decided by $V_{OUT} = -1.25V * (R1 + R2) / R1 (V)$.

PACKAGE SPECIFICATION

8-PIN NSOIC

Unit: mm (inch)

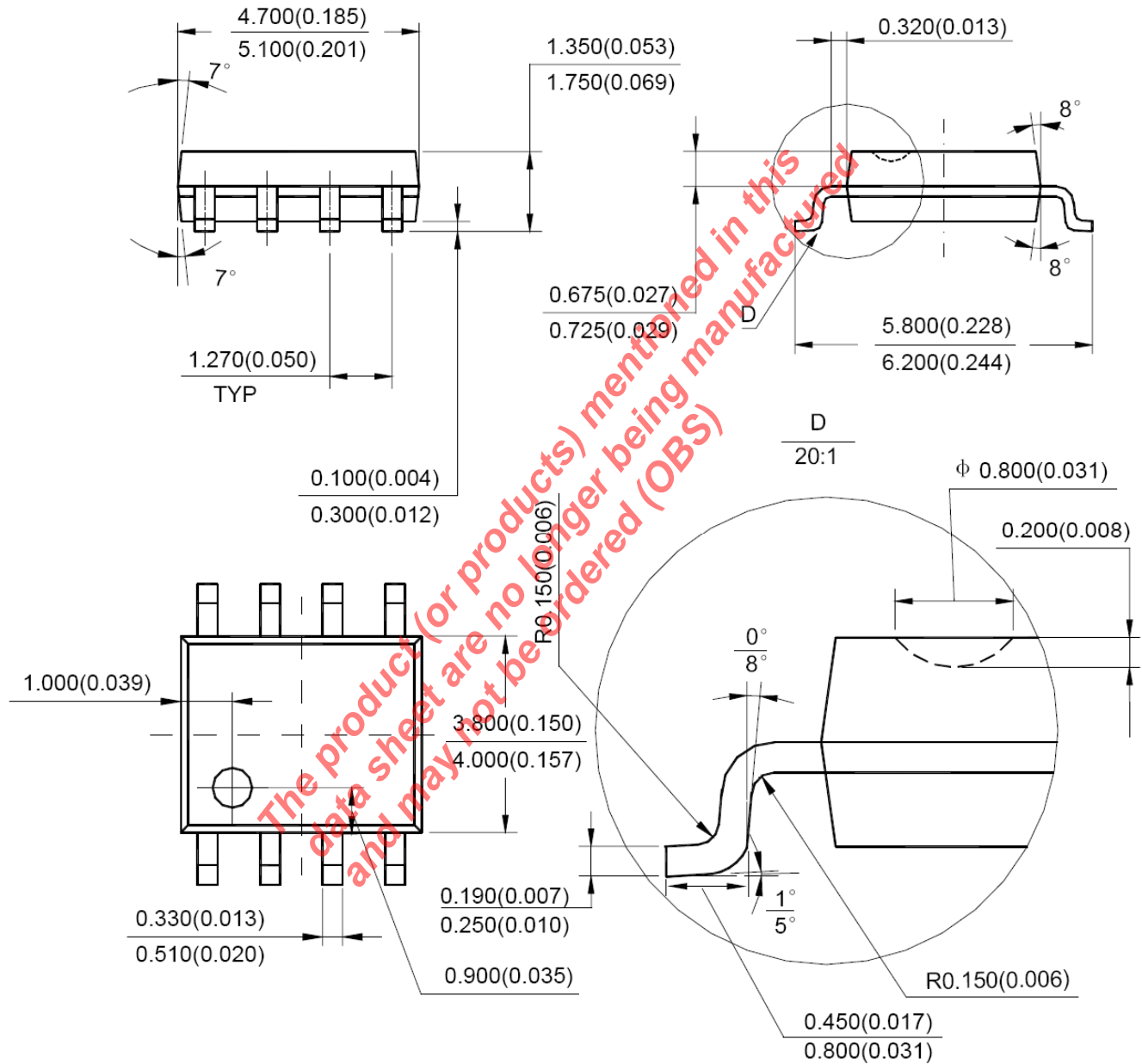

The product (or products) mentioned in this data sheet are no longer being manufactured and may not be ordered (OBS)

REVISION HISTORY

Revision	Date	Description
2.0.0	01/16/2009	Reformat of Datasheet
2.0.1	8/24/2010	Pg1, changed operation frequency from 110kHz to 180kHz Fig. 6: Changed title to: Oscillator Frequency vs. Timing Capacitor Pg7, Corrected the inverting converter circuit
2.1.0	02/14/2011	Corrected Power Dissipation value to 780mW under Operating Ratings Added $C_T = fct(T_{ON})$ formula on figure 10 graph Updated package specification
2.1.1	02/06/2014	Updated figure 4 and 6 [ECN 1407-07]

FOR FURTHER ASSISTANCE

Email:

customersupport@exar.com

Exar Technical Documentation:

<http://www.exar.com/TechDoc/default.aspx?>



A New Direction in Mixed-Signal

EXAR CORPORATION

HEADQUARTERS AND SALES OFFICES

48720 Kato Road

Fremont, CA 94538 – USA

Tel.: +1 (510) 668-7000

Fax: +1 (510) 668-7030

www.exar.com

NOTICE

EXAR Corporation reserves the right to make changes to the products contained in this publication in order to improve design, performance or reliability. EXAR Corporation assumes no responsibility for the use of any circuits described herein, conveys no license under any patent or other right, and makes no representation that the circuits are free of patent infringement. Charts and schedules contained here in are only for illustration purposes and may vary depending upon a user's specific application. While the information in this publication has been carefully checked; no responsibility, however, is assumed for inaccuracies.

EXAR Corporation does not recommend the use of any of its products in life support applications where the failure or malfunction of the product can reasonably be expected to cause failure of the life support system or to significantly affect its safety or effectiveness. Products are not authorized for use in such applications unless EXAR Corporation receives, in writing, assurances to its satisfaction that: (a) the risk of injury or damage has been minimized; (b) the user assumes all such risks; (c) potential liability of EXAR Corporation is adequately protected under the circumstances.

Reproduction, in part or whole, without the prior written consent of EXAR Corporation is prohibited.

Looking for pricing, stock, or lifecycle information?

Click below to explore more details on WIN SOURCE:

 [View RN112-0.6/02 on WIN SOURCE](#)

 [Schaffner EMC Inc. Information](#)

Optimize Your Supply Chain with WIN SOURCE Solutions

-  Global Sourcing Solution
-  Obsolete Management
-  Cost Control Management
-  Shortage Management
-  Alternative Solution
-  Excess Inventory Management