



# THE DATASHEET OF RN-2405S



# Features

- 1kVDC/1s or 2kVDC/1s basic isolation
- Optional continuous short circuit protected
- UL94V-0 package material
- No heatsink required
- Efficiency to 85%

# Unregulated Converters

## RN

**1.25 Watt**  
**DIP8**  
**Single Output**



### Description

The RN series of compact 1.25W single output converters are especially useful when more than 1W of power is required, but there are space restrictions than make a 2W converter unsuitable. The converter series feature an industrial ambient temperature operating range of -40°C to +85°C without derating and up to 100°C ambient temperature with derating. Options include 1kVDC or 2kVDC isolation and continuous short circuit protection (/P).

### Selection Guide

Part Number	nom. Input Voltage [VDC]	Output Voltage [VDC]	Output Current [mA]	Efficiency typ. <sup>(1)</sup> [%]	max. Capacitive Load <sup>(2)</sup> [µF]
RN-xx3.3S	3.3, 5, 9, 12, 15, 24	3.3	378	70	2200
RN-xx05S	3.3, 5, 9, 12, 15, 24	5	250	70-72	1000
RN-xx07S	3.3, 5, 9, 12, 15, 24	7	180	72-75	1000
RN-xx09S	3.3, 5, 9, 12, 15, 24	9	140	75-80	1000
RN-xx12S	3.3, 5, 9, 12, 15, 24	12	104	79-82	470
RN-xx15S	3.3, 5, 9, 12, 15, 24	15	84	80-84	470
RN-xx24S	3.3, 5, 9, 12, 15, 24	24	52	80-85	220

#### Notes:

Note1: Efficiency is tested at nominal input and full load at +25°C ambient

Note2: Max Cap Load is tested at nominal input and full resistive load and is defined as the capacitive load that will allow start up in under 1s without damage to the converter



IEC/EN60950-1 certified

### Model Numbering

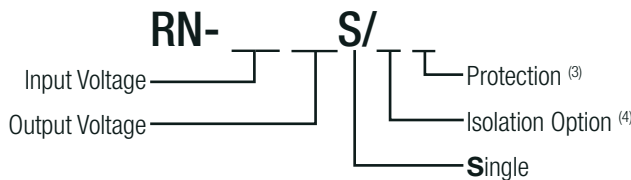

#### Notes:

Note3: standard part is without continuous short circuit protection  
add suffix „/P“ for continuous short circuit protection

Note4: add suffix „/H“ for 2kVDC/1s isolation  
or add suffix „/HP“ for continuous short circuit protection and 2kVDC/1s Isolation

#### Ordering Examples:

RN-0505S/P: 5V Input Voltage, 5V Output Voltage, Single Output with continuous short circuit protection

RN-0505S/HP: 5V Input Voltage, 5V Output Voltage, Single Output with 2kVDC/1s Isolation and continuous short circuit protection

**Specifications** (measured @ Ta= 25°C, nom. Vin, full load and after warm-up unless otherwise stated)

### BASIC CHARACTERISTICS

Parameter	Condition	Min.	Typ.	Max.
Input Voltage Range			±10%	
Minimum Load		0%		
Internal Operating Frequency		50kHz	100kHz	105kHz
Output Ripple and Noise	20MHz BW			75mVp-p

### Efficiency vs. Load

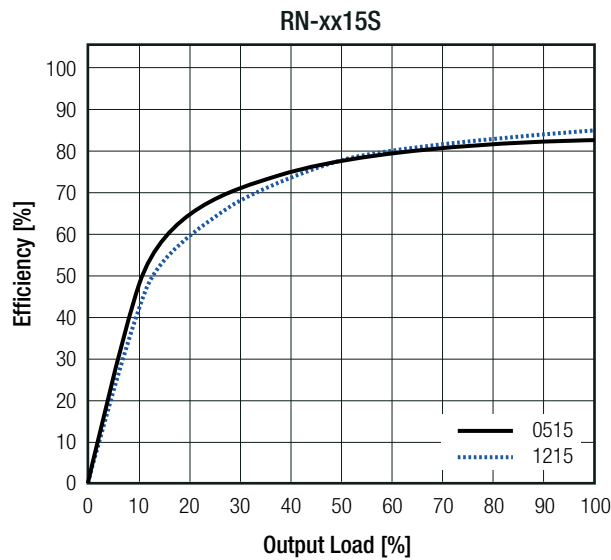
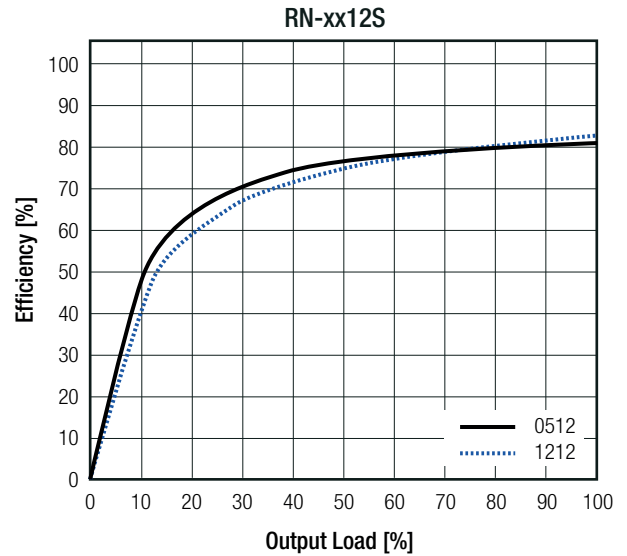
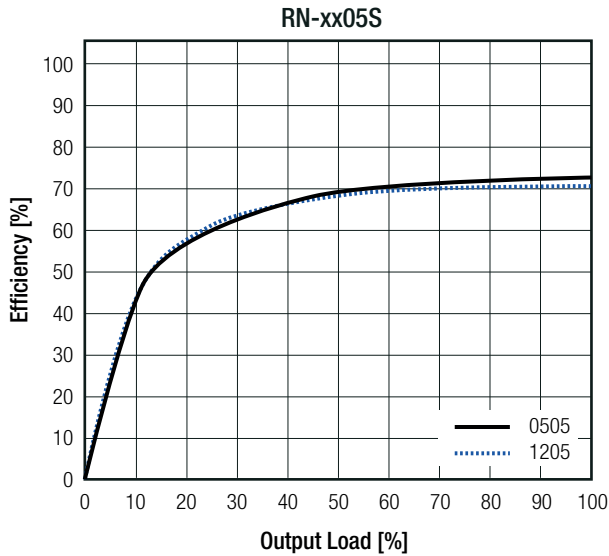

### REGULATIONS

Parameter	Condition		Value
Output Accuracy			±5.0% max.
Line Regulation	low line to high line		±1.2% typ. / ±1.4% max.
Load Regulation <sup>(5)</sup>	10% to 100% load	3.3Vout	20.0% max.
		5Vout	15.0% max.
		9, 12, 15, 24Vout	10.0% max.

**Notes:**

Note5: Operation below 10% load will not harm the converter, but specifications may not be met

continued on next page

**Specifications** (measured @ Ta= 25°C, nom. Vin, full load and after warm-up unless otherwise stated)

Deviation vs. Load

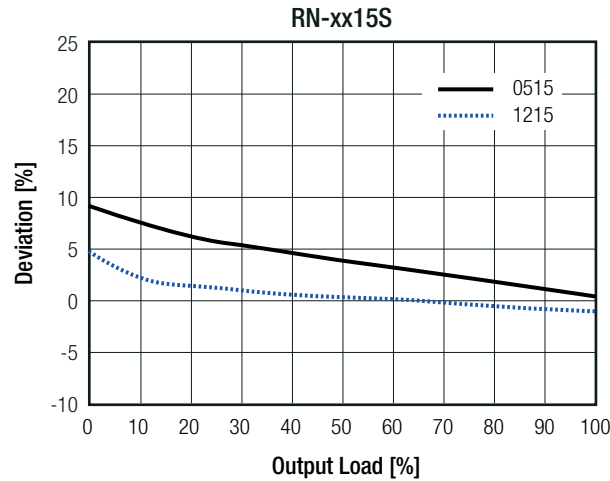
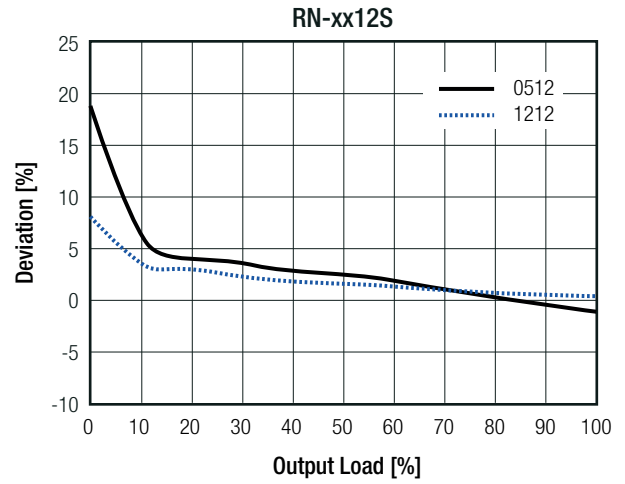
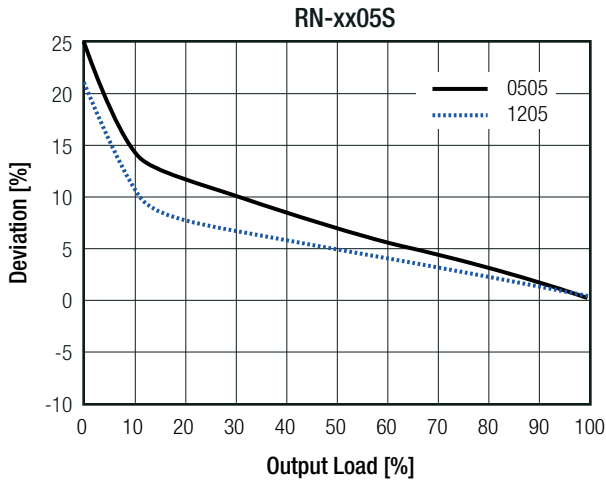

**PROTECTIONS**

Parameter	Type		Value
Short Circuit Protection (SCP)	without suffix with suffix "/P"		1 second continuous
Isolation Voltage <sup>(6)</sup>	I/P to O/P	without suffix	tested for 1 second rated for 1 minute 1kVDC 500VAC/60Hz
		with suffix "/H"	tested for 1 second rated for 1 minute 2kVDC 1kVAC/60Hz
Isolation Resistance			10GΩ min.
Isolation Capacitance			30pF min. / 95pF max.
Insulation Grade			basic

**Notes:**

Note6: For repeat Hi-Pot testing, reduce the time and/or the test voltage

Note7: Refer to local safety regulations if input over-current protection is also required. Recommended fuse: slow blow type

**Specifications** (measured @ Ta= 25°C, nom. Vin, full load and after warm-up unless otherwise stated)

ENVIRONMENTAL			
Parameter	Condition		Value
Operating Temperature Range	full load @ free air convection (see graph)		-40°C to +85°C
Operating Altitude			2000m
Operating Humidity	non-condensing		95% RH max.
Pollution Degree			PD2
MTBF	according to MIL-HDBK-217F, G.B.	+25°C	955 x 10 <sup>3</sup> hours
		+85°C	132 x 10 <sup>3</sup> hours

**Derating Graph**  
(@ free air convection)

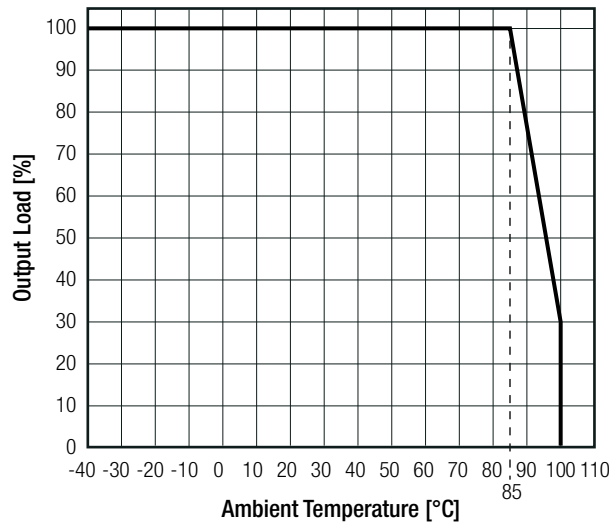

SAFETY AND CERTIFICATIONS		
Certificate Type (Safety)	Report / File Number	Standard
Information Technology Equipment, General Requirements for Safety	1602031	IEC60950-1:2005, 2nd Edition + A2:2013 EN60950-1:2006 + A2:2013
EAC	RU-AT.49.09571	TP TC 004/2011
RoHS 2+		RoHS-2011/65/EU + AM-2015/863

DIMENSION AND PHYSICAL CHARACTERISTICS		
Parameter	Type	Value
Material	case	non-conductive black plastic, (UL94 V-0)
	potting	epoxy, (UL94 V-0)
	PCB	FR4, (UL94 V-0)
Dimension (LxWxH)		12.6 x 10.1 x 7.62mm
Weight		1.9g typ.

continued on next page

**Specifications** (measured @ Ta= 25°C, nom. Vin, full load and after warm-up unless otherwise stated)

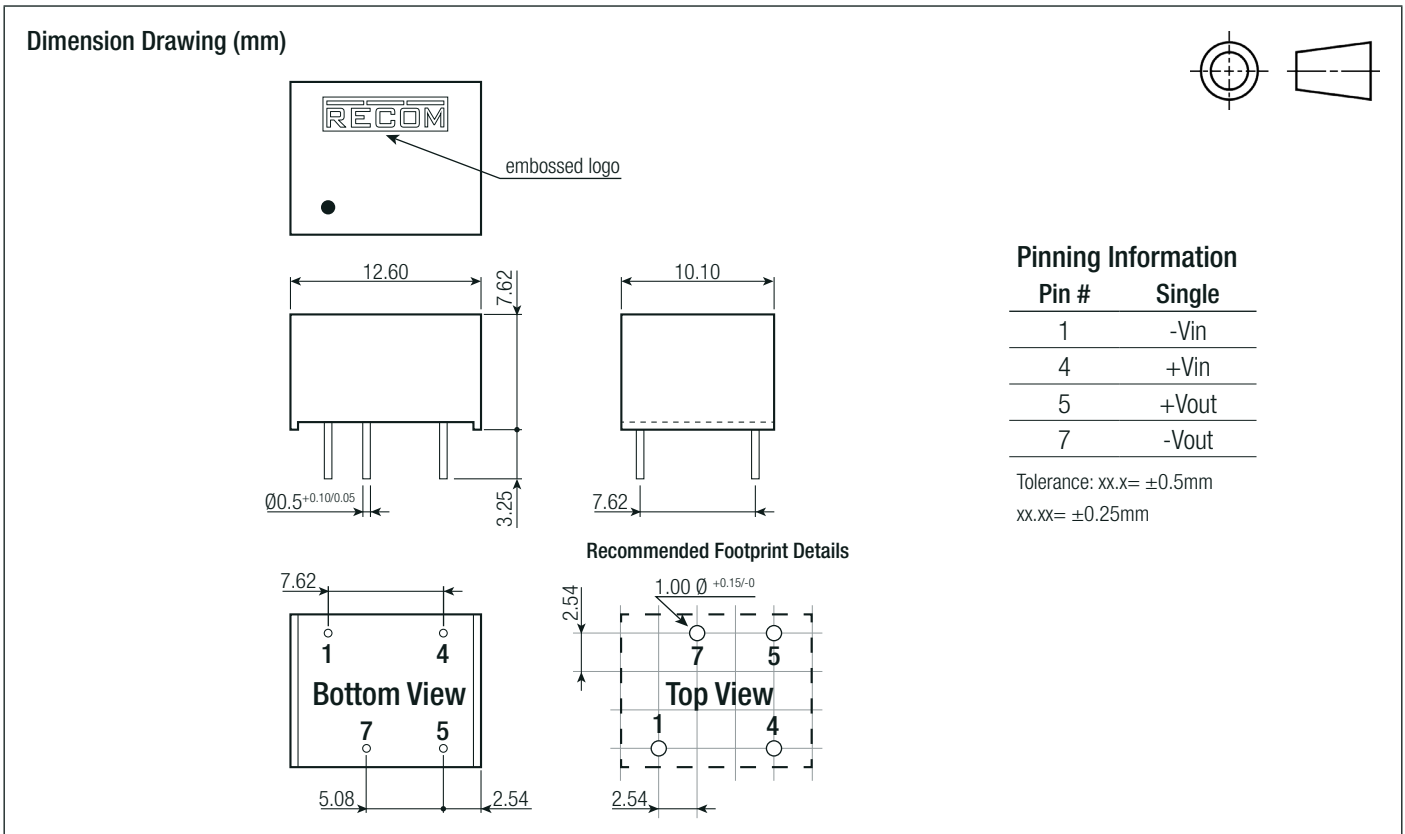



**PACKAGING INFORMATION**

Parameter	Type	Value
Packaging Dimension (LxWxH)	tube	520.0 x 15.0 x 16.0mm
Packaging Quantity		39pcs
Storage Temperature Range		-55°C to +125°C
Storage Humidity	non-condensing	95% RH max.

The product information and specifications may be subject to changes even without prior written notice. The product has been designed for various applications; its suitability lies in the responsibility of each customer. The products are not authorized for use in safety-critical applications without RECOM's explicit written consent. A safety-critical application is an application where a failure may reasonably be expected to endanger or cause loss of life, inflict bodily harm or damage property. The applicant shall indemnify and hold harmless RECOM, its affiliated companies and its representatives against any damage claims in connection with the unauthorized use of RECOM products in such safety-critical applications.

## Looking for pricing, stock, or lifecycle information?

Click below to explore more details on WIN SOURCE:

-  [View RN-2405S](#) on WIN SOURCE
-  [Recom Power](#) Information

## Optimize Your Supply Chain with WIN SOURCE Solutions

-  Global Sourcing Solution
-  Obsolete Management
-  Cost Control Management
-  Shortage Management
-  Alternative Solution
-  Excess Inventory Management