



**THE DATASHEET OF  
RT9992ZQW**



## 5+2 CH DC/DC Converters for DV

### General Description

This is a 5+2 CH integrated PMIC for DV application. There are 5 DC/DC converters : one synchronous step-up, one selectable synchronous step-up/step-down, two synchronous step-downs, and one WLED driver in either asynchronous step-up or current source mode, selectable by VOUT6 initial voltage. In addition, there are 2 LDO regulators : one RTC LDO and one generic LDO. The generic LDO can choose internal feedback loop for fixed output 2.5V or external feedback loop for customized output voltage. Both low voltage synchronous step-up converters are with load disconnect function. All power MOSFETs and compensation networks are integrated. There is a power good indicator to monitor FB2, FB3, and FB4 voltage status. CH1 to CH5 enabling can be controlled flexibly : enabled independently or in preset sequences.

### Ordering Information

RT9992□□

- Package Type  
QW : WQFN-32L 4x4 (W-Type)
- Lead Plating System  
Z : ECO (Ecological Element with Halogen Free and Pb free)

Note :

Richtek products are :

- ▶ RoHS compliant and compatible with the current requirements of IPC/JEDEC J-STD-020.
- ▶ Suitable for use in SnPb or Pb-free soldering processes.

### Pin Configuration

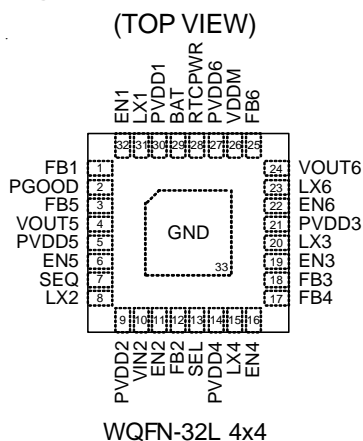

### Features

- All Power MOSFETs Integrated
- 5 Channels with Internal Compensation
- Flexible Enabling Control
  - ▶ Enabled Independently or in Preset Power On/Off Sequences
- CH2 Synchronous Converter in Step-Up or Step-Down Mode Selectable by SEL Pin
- Synchronous Step-Down DC/DC Converter
  - ▶ Up to 95% Efficiency
  - ▶ 100% (max) Duty Cycle
- Synchronous Step-Up DC/DC Converter
  - ▶ Adjustable Output Voltage
  - ▶ Up to 95% Efficiency
- Asynchronous Step-Up Converter to Drive WLED, Selectable Between Step-Up or Current Source
  - ▶ LED Open Protection (OVP6) in Step-Up Mode
  - ▶ PWM Dimming Control
- Load Disconnect Function for CH1 and CH2 Synchronous Step-Up Converter
- Fixed 2MHz Switching Frequency for CH1, CH2, CH3, and CH4
- Fixed 1MHz Switching Frequency for CH6
- Generic LDO (CH5)
  - ▶ Output Voltage : Fixed 2.5V or Set by External Feedback Network, Determined by FB5 Initial Voltage
- RTC LDO : Fixed Output Voltage 3.1V
- Power Good Indicator to Monitor Output Voltage Status of CH2, CH3, and CH4
- 32-Lead Package
- RoHS Compliant and Halogen Free

### Applications

- CMOS DV
- Gaming

### Marking Information

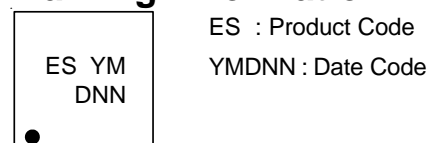

## Typical Application Circuit

For 2AA :

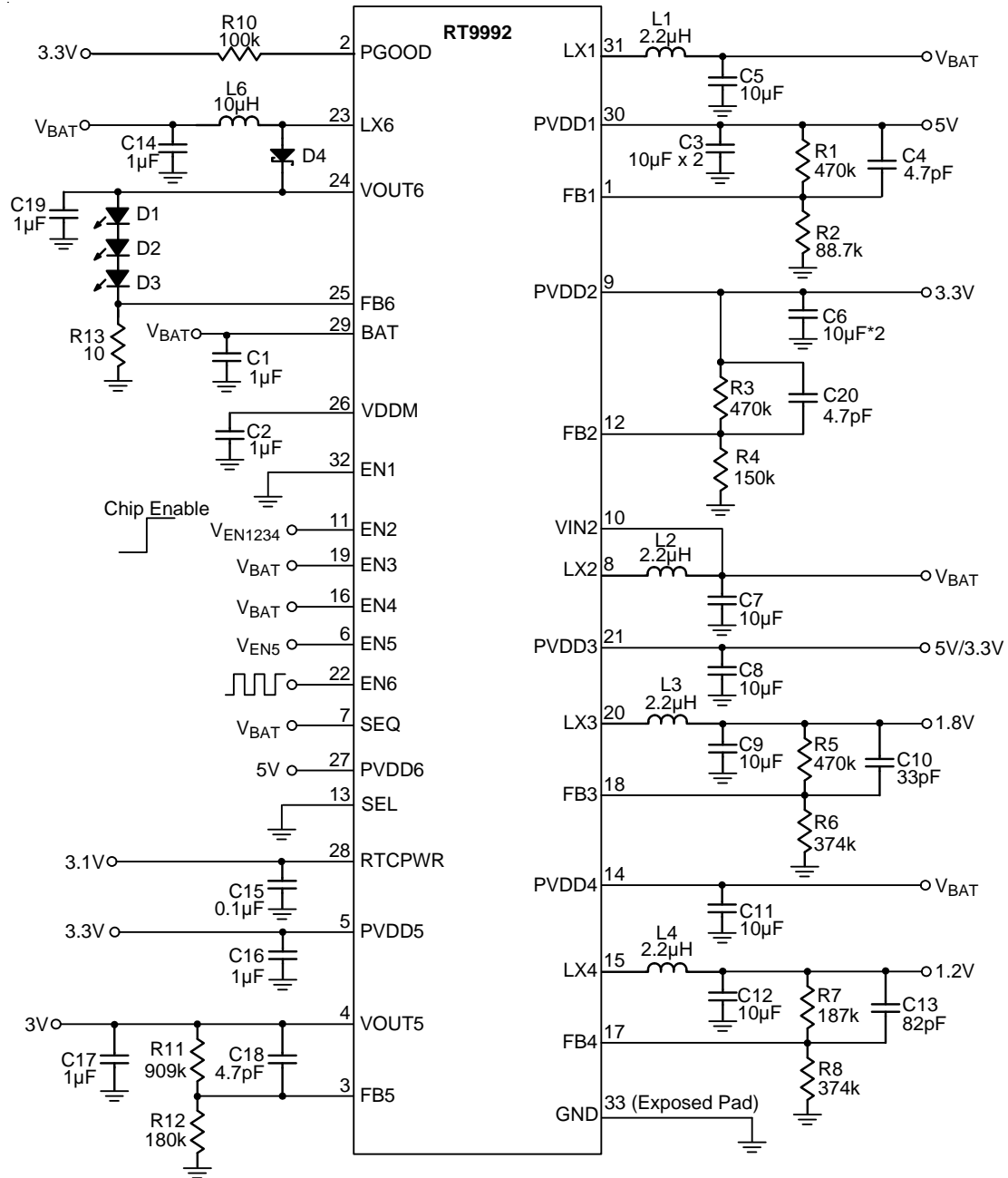

For above circuit, the power sequence is CH1 → CH3 → CH4 → CH2, while CH5 remains independent.

For other power sequence combinations, refer to the power on/off sequence section in application information.

For Li+ :

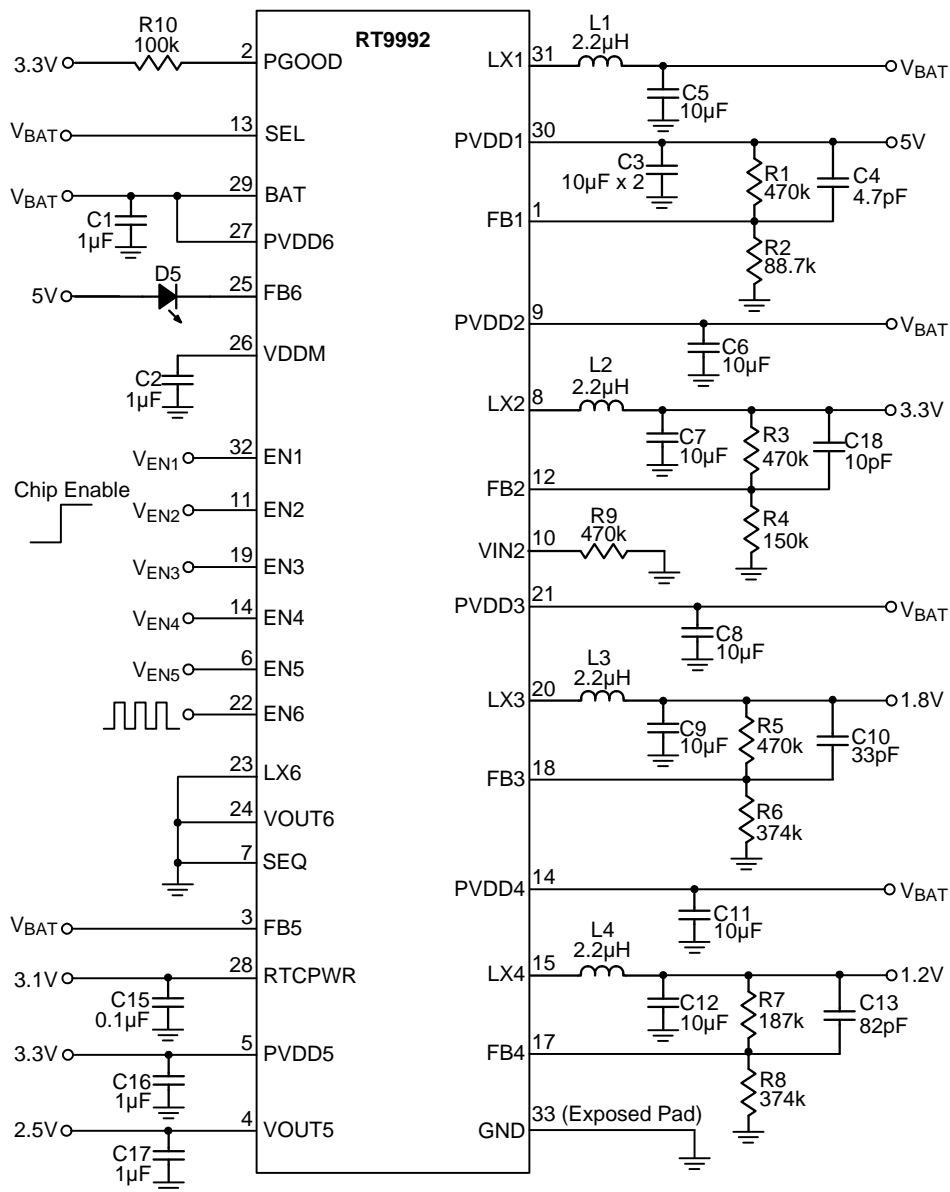

For above circuit, all channels are independently enabled/disabled.

For other power sequence combinations, refer to the power on/off sequence section in application information.

Table 1. Recommended Components for the Typical Application Circuit

Channel	CH3					
Calculation	$V_{OUT\_CH3} = (1 + R5 / R6) \times 0.8V$					
V <sub>OUT</sub> (V)	2.5	1.8	1.5	1.3	1.2	1
L3 (μH)	2.2	2.2	2.2	2.2	2.2	2.2
R5 (kΩ)	768	470	330	237	187	23.2
R6 (kΩ)	360	374	374	374	374	93.1
C9 (μF)	10	10	10	10	10	10
C10 (pF)	22	33	47	68	82	47

Channel	CH4					
Calculation	$V_{OUT\_CH4} = (1 + R7 / R8) \times 0.8V$					
V <sub>OUT</sub> (V)	2.5	1.8	1.5	1.3	1.2	1
L4 (μH)	2.2	2.2	2.2	2.2	2.2	2.2
R7 (kΩ)	768	470	330	237	187	23.2
R8 (kΩ)	360	374	374	374	374	93.1
C12 (μF)	10	10	10	10	10	10
C13 (pF)	22	33	47	68	82	47

Where C9, C12 are C<sub>OUT</sub>,

C10, C13 are feedforward cap between output and FB

R5, R7 are the feedback resistor between output and FB

R6, R8 are the feedback resistor between GND and FB

**Functional Pin Description**

Pin No.	Pin Name	Pin Function
1	FB1	Feedback input pin of CH1. High impedance in shutdown.
2	PGOOD	Power good indicator output pin (Open drain).
3	FB5	Feedback input pin of CH5. High impedance in shutdown.
4	VOUT5	Output pin for CH5. High impedance in shutdown.
5	PVDD5	Power input pin of CH5.
6	EN5	Enable pin of CH5.
7	SEQ	SEQ = H to use preset power on/off sequence. SEQ = L to independently enable CH1 to 5. Logic state can't be changed during operation.
8	LX2	Switch node of CH2. High impedance in shutdown.
9	PVDD2	Power input pin of CH2 in Step-Down or power output pin of CH2 in step-up.
10	VIN2	Power input node of CH2 in step-up.
11	EN2	Enable pin of CH2 or enable pin of preset On/Off sequence.
12	FB2	Feedback input pin of CH2. High impedance in shutdown.
13	SEL	Select pin to define CH2 in step-down (SEL = H) or step-up (SEL = L) mode. Logic state can't be changed during operation.
14	PVDD4	Power input pin of CH4.
15	LX4	Switch node of CH4. High impedance in shutdown.
16	EN4	Enable pin of CH4 or Select which preset On/Off sequence.
17	FB4	Feedback input pin of CH4. High impedance in shutdown.
18	FB3	Feedback input pin of CH3. High impedance in shutdown.
19	EN3	Enable pin of CH3 or select which preset On/Off sequence.
20	LX3	Switch node of CH3. High impedance in shutdown.
21	PVDD3	Power input pin of CH3.
22	EN6	Enable pin of CH6 and PWM dimming input signal pin.
23	LX6	Switch node of CH6 in step-up mode. High impedance in shutdown.
24	VOUT6	Sense pin for CH6 output voltage in step-up mode and CH6 mode selection pin.
25	FB6	Feedback input pin of CH6 in step-up mode or current sink pin of CH6 in current source mode.
26	VDDM	Internal control circuit power pin. That must connect to a bypass capacitor for better noise rejection.
27	PVDD6	Power input pin of CH6 N-MOSFET Driver.
28	RTCPWR	RTC power output pin.
29	BAT	Battery power input pin and CH1 step-up power input node.
30	PVDD1	Power output pin of CH1.
31	LX1	Switch node of CH1. High impedance in shutdown.
32	EN1	Enable pin of CH1.
33 (Exposed pad)	GND	Ground. The exposed pad must be soldered to a large PCB and connected to GND for maximum power dissipation.

Functional Block Diagram

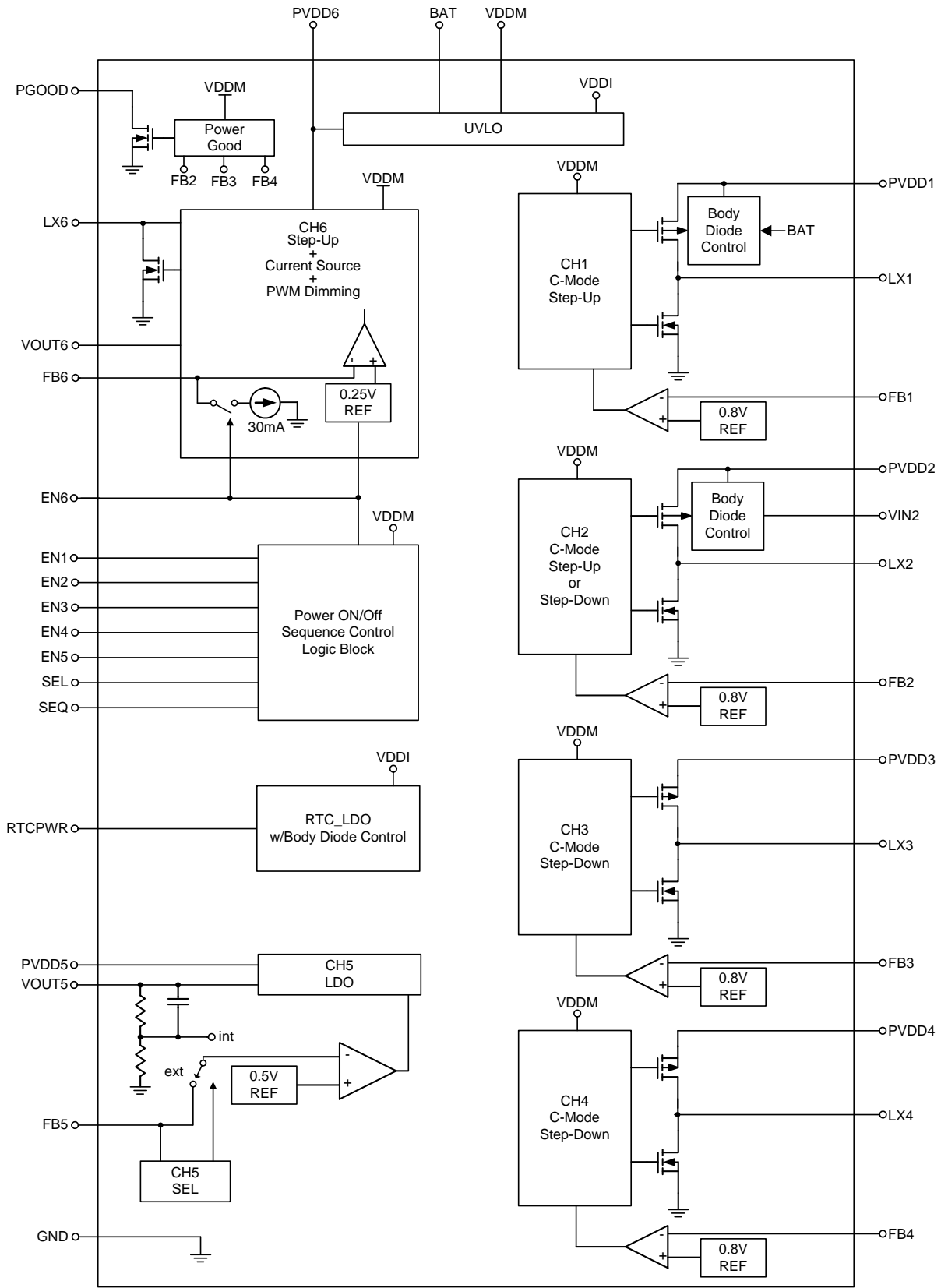

**Absolute Maximum Ratings** (Note 1)

- Supply Input Voltage, VDDM ----- -0.3V to 7V
- LX1, LX2, LX3, LX4 ----- -0.3V to 7V  
   < 20ns ----- -0.3V to 10V
- LX6, VOUT6 ----- -0.3V to 21V  
   < 20ns ----- -8V to 24V
- Other Pins ----- -0.3V to 7V
- Power Dissipation, P<sub>D</sub> @ T<sub>A</sub> = 25°C  
   WQFN-32L 4x4 ----- 3.59W
- Package Thermal Resistance (Note 2)  
   WQFN-32L 4x4, θ<sub>JA</sub> ----- 27.8°C/W  
   WQFN-32L 4x4, θ<sub>JC</sub> ----- 7°C/W
- Junction Temperature ----- 150°C
- Lead Temperature (Soldering, 10 sec.) ----- 260°C
- Storage Temperature Range ----- -65°C to 150°C
- ESD Susceptibility (Note 3)  
   HBM (Human Body Mode) ----- 2kV

**Recommended Operating Conditions** (Note 4)

- Supply Input Voltage VDDM ----- 2.7V to 5.5V
- Junction Temperature Range ----- -40°C to 125°C
- Ambient Temperature Range ----- -40°C to 85°C

**Electrical Characteristics**

(V<sub>DDM</sub> = 3.3V, T<sub>A</sub> = 25°C, unless otherwise specified)

Parameter	Symbol	Test Conditions	Min	Typ	Max	Unit
<b>Supply Voltage</b>						
VDDM Startup Voltage	V <sub>ST</sub>	For Bootstrap, First Rising	1.5	--	--	V
<b>Supply Current</b>						
Shutdown Supply Current into BAT (including RTC LDO quiescent current)		V <sub>BAT</sub> = 4.2V, V <sub>PVDD6</sub> = 3V	--	7	12	μA
Shutdown Supply Current into PVDD6		V <sub>BAT</sub> = 4.2V, V <sub>PVDD6</sub> < V <sub>BAT</sub>	--	--	1	μA
Shutdown Supply Current into VDDM	I <sub>OFF</sub>	EN <sub>x</sub> = 0, V <sub>SEQ</sub> = 0V, SEL = 0V	--	1	10	μA
CH1 (Synchronous Step-Up) Supply Current into VDDM	I <sub>Q1</sub>	Non Switching, V <sub>EN1</sub> = 3.3V, V <sub>FB1</sub> = 0.9V, V <sub>SEQ</sub> = 0V	--	--	800	μA
CH2 (Synchronous Step-Up or Step-Down) Supply Current into VDDM	I <sub>Q2</sub>	Non Switching, V <sub>EN2</sub> = 3.3V, V <sub>FB2</sub> = 0.9V, V <sub>SEQ</sub> = 0V	--	--	800	μA
CH3 (Synchronous Step-Down) Supply Current into VDDM	I <sub>Q3</sub>	Non Switching, V <sub>EN3</sub> = 3.3V, V <sub>FB3</sub> = 0.9V, V <sub>SEQ</sub> = 0V	--	--	800	μA

Parameter	Symbol	Test Conditions	Min	Typ	Max	Unit
CH4 (Synchronous Step-Down) Supply Current into VDDM	I <sub>Q4</sub>	Non Switching, V <sub>EN4</sub> = 3.3V, V <sub>FB4</sub> = 0.9V, V <sub>SEQ</sub> = 0V	--	--	800	μA
CH6 (WLED) in Current Source Mode Supply Current into VDDM	I <sub>Q6c</sub>	V <sub>EN6</sub> = 3.3V, V <sub>OUT6</sub> = 0V	--	--	600	μA
CH6 (WLED) in Asynchronous Step-Up Mode Supply Current into VDDM	I <sub>Q6b</sub>	Non switching, V <sub>EN6</sub> = 3.3V, V <sub>FB6</sub> = 0.35V, V <sub>OUT6</sub> = 1V	--	--	800	μA
<b>Oscillator</b>						
CH1, 2, 3, 4 Operation Frequency	f <sub>OSC</sub>		1800	2000	2200	kHz
CH6 Operation Frequency	f <sub>OSC6</sub>		900	1000	1100	kHz
CH1 Maximum Duty Cycle (Step-Up)		V <sub>FB1</sub> = 0.7V	80	83.5	87	%
CH2 Maximum Duty Cycle (Step-Up)		V <sub>FB2</sub> = 0.7V	80	83.5	87	%
CH2 Maximum Duty Cycle (Step-Down)		V <sub>FB2</sub> = 0.7V	--	--	100	%
CH3 Maximum Duty Cycle (Step-Down)		V <sub>FB3</sub> = 0.7V	--	--	100	%
CH4 Maximum Duty Cycle (Step-Down)		V <sub>FB4</sub> = 0.7V	--	--	100	%
CH6 Maximum Duty Cycle (Step-Up)		V <sub>FB6</sub> = 0.15V, V <sub>OUT6</sub> = 1V	91	93	97	%
<b>Feedback and output Regulation Voltage</b>						
Feedback Regulation Voltage @ FB1, FB2, FB3, and FB4			0.788	0.8	0.812	V
Sink Current into FB6 (CS mode)		V <sub>OUT6</sub> = 0V, Current Source	28.5	30	31.5	mA
Dropout Voltage @ FB6 (CS mode)		V <sub>OUT6</sub> = 0V, V <sub>VDDM</sub> = 3.3V, Current Source	--	--	0.6	V
Feedback Regulation Voltage @ FB6	V <sub>FB6</sub>	V <sub>OUT6</sub> = 1V, Step-Up	0.237	0.25	0.263	V
<b>Power Switch</b>						
CH1 On Resistance of MOSFET	R <sub>DS(ON)</sub>	P-MOSFET, V <sub>PVDD1</sub> = 3.3V	--	200	300	mΩ
		N-MOSFET, V <sub>PVDD1</sub> = 3.3V	--	130	250	
CH1 Current Limitation (Step-Up)	I <sub>LIM1</sub>		2.2	3	4	A
CH2 On Resistance of MOSFET	R <sub>DS(ON)</sub>	P-MOSFET, V <sub>PVDD2</sub> = 3.3V	--	400	550	mΩ
		N-MOSFET, V <sub>PVDD2</sub> = 3.3V	--	260	400	
CH2 Current Limitation (Step-Down)	I <sub>LIM2_D</sub>		1	1.5	2	A
CH2 Current Limitation (Step-Up)	I <sub>LIM2_U</sub>		1.5	2.1	3	A
CH3 On Resistance of MOSFET	R <sub>DS(ON)</sub>	P-MOSFET, V <sub>PVDD3</sub> = 3.3V	--	370	500	mΩ
		N-MOSFET, V <sub>PVDD3</sub> = 3.3V	--	300	400	
CH3 Current Limitation (Step-Down)	I <sub>LIM3</sub>		1	1.5	2	A
CH4 On Resistance of MOSFET	R <sub>DS(ON)</sub>	P-MOSFET, V <sub>PVDD4</sub> = 3.3V	--	240	400	mΩ
		N-MOSFET, V <sub>PVDD4</sub> = 3.3V	--	140	250	
CH4 Current Limitation (Step-Down)	I <sub>LIM4</sub>		1.5	2	2.4	A
CH6 On Resistance of MOSFET	R <sub>DS(ON)</sub>	N-MOSFET	--	0.75	1.1	Ω
CH6 Current Limitation	I <sub>LIM6</sub>	N-MOSFET	0.6	0.8	1	A

Parameter	Symbol	Test Conditions	Min	Typ	Max	Unit
<b>Protection</b>						
Over Voltage Protection PVDD1,PVDD2 (CH2 in Step-Up)			5.9	6.15	6.4	V
Over Voltage Protection @ VOUT6	V <sub>OVP6</sub>	Step-Up	18	19.5	21	V
Under Voltage Protection @ FB1, FB2, FB3, FB4	V <sub>UVP1234</sub>		--	0.4	--	V
Under Voltage Protection @ FB5	V <sub>UVP5</sub>		--	0.3	--	V
VDDM Over Voltage Protection			5.9	6.15	6.4	V
VDDM UVLO Threshold		VDDM Rising		2.4	2.7	V
		VDDM Falling	1.7	2.1	2.4	
BAT UVLO Threshold		BAT Rising	1.3	1.4	1.5	V
		BAT Falling	1.2	1.3	1.4	
Protection Fault Delay		Except OVP1/2	--	100	--	ms
<b>Control</b>						
EN1 to 6, SEL, SEQ Threshold Voltage	Logic-High	V <sub>IH</sub>	1.3	--	--	V
	Logic-Low	V <sub>IL</sub>	--	--	0.4	
EN1 to 5, SEL, SEQ Sink Current			--	1	6	μA
EN6 Sink Current			--	4	20	μA
EN6 Low Time for Shutdown	t <sub>SHDN</sub>		--	32.7	--	ms
EN6 High Time for CH6 Enable			--	1.2	5	μs
<b>Thermal Protection</b>						
Thermal Shutdown	T <sub>SD</sub>		125	160	--	°C
Thermal Shutdown Hysteresis	ΔT <sub>SD</sub>		--	20	--	°C
<b>CH5 LDO (C<sub>OUT</sub> = 1μF for Better Stability)</b>						
Input Voltage Range (PVDD5)	V <sub>PVDD5</sub>		2.7	--	5.5	V
Output Voltage Range	V <sub>OUT5</sub>	By external feedback	0.6	--	4.5	V
Feedback Regulation Voltage @ FB5	V <sub>FB5</sub>	Using external feedback loop	0.493	0.5	0.507	V
Regulated Output Voltage @ VOUT5	V <sub>REG5</sub>	Using internal feedback loop	2.45	2.5	2.55	V
FB5 Threshold to Select Internal Feedback Network		(Note : before enabled, V <sub>FB5</sub> > 0.8V. Then CH5 uses internal feedback)	0.8	--	--	V
Max Current Limit	I <sub>LIM5</sub>	V <sub>PVDD5</sub> = 3.3V	300	380	500	mA
Dropout Voltage		I <sub>OUT</sub> = 100mA	60	100	120	mV
Soft-Start Time	t <sub>SS5</sub>	V <sub>FB5</sub> = 0 to 0.5V	--	2.4	--	ms
PSRR+		I <sub>OUT</sub> = 10mA, V <sub>PVDD5</sub> = 3.3V, V <sub>OUT</sub> = 2.5V, 1kHz	--	-55	--	db

Parameter	Symbol	Test Conditions	Min	Typ	Max	Unit
<b>RTC LDO for RTCPWR (Keep On Once Bat Connect)</b>						
Input Voltage Range	V <sub>DDI</sub>	Max of BAT and PVDD6	--	--	5.5	V
Quiescent Current	I <sub>Q</sub>	V <sub>DDI</sub> = 4.2V	--	5	8	μA
Regulated Output Voltage @ RTCPWR		I <sub>OUT</sub> = 0mA	3.0	3.1	3.2	V
Max Output Current (Current Limit)		V <sub>DDI</sub> = 4.2V	60	105	200	mA
Dropout Voltage	V <sub>DROP</sub>	I <sub>OUT</sub> = 50mA	--	740	1000	mV
		I <sub>OUT</sub> = 10mA	--	110	200	
		I <sub>OUT</sub> = 3mA	--	60	100	
<b>Power Good Indicator</b>						
FB2 Regulation Threshold		For PGOOD Go Low	0.6	0.66	0.74	V
FB2 Hysteresis			--	40	--	mV
FB3 Regulation Threshold		For PGOOD Go Low	0.6	0.66	0.74	V
FB3 Hysteresis			--	40	--	mV
FB4 Regulation Threshold		For PGOOD Go Low	0.6	0.66	0.74	V
FB4 Hysteresis			--	40	--	mV
PGOOD Rising Delay Time			13	14.4	15.9	ms
PGOOD Sink Capability		V <sub>DDM</sub> = 3.3V, V <sub>PGOOD</sub> = 0.5V	4	--	--	mA
<b>Soft-Start Time</b>						
CH1 Soft-Start Time	t <sub>SS1</sub>	V <sub>FB1</sub> = 0 to 0.8V	2.8	3.5	4.2	ms
CH2 Soft-Start Time	t <sub>SS2</sub>	V <sub>FB2</sub> = 0 to 0.8V	2.8	3.5	4.2	ms
CH3 Soft-Start Time	t <sub>SS3</sub>	V <sub>FB3</sub> = 0 to 0.8V	2.8	3.5	4.2	ms
CH4 Soft-Start Time	t <sub>SS4</sub>	V <sub>FB4</sub> = 0 to 0.8V	2.8	3.5	4.2	ms

**Note 1.** Stresses beyond those listed under “Absolute Maximum Ratings” may cause permanent damage to the device. These are stress ratings only, and functional operation of the device at these or any other conditions beyond those indicated in the operational sections of the specifications is not implied. Exposure to absolute maximum rating conditions may affect device reliability.

**Note 2.** θ<sub>JA</sub> is measured at T<sub>A</sub> = 25°C on a high effective thermal conductivity four-layer test board per JEDEC 51-7. θ<sub>JC</sub> is measured at the exposed pad of the package.

**Note 3.** Devices are ESD sensitive. Handling precaution is recommended.

**Note 4.** The device is not guaranteed to function outside its operating conditions.

**Typical Operating Characteristics**

**CH1 Step-Up Efficiency vs. Output Current**

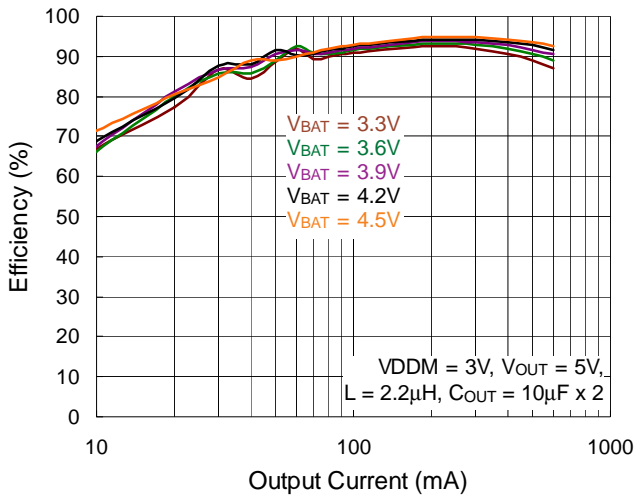

**CH2 Step-Up Efficiency vs. Output Current**

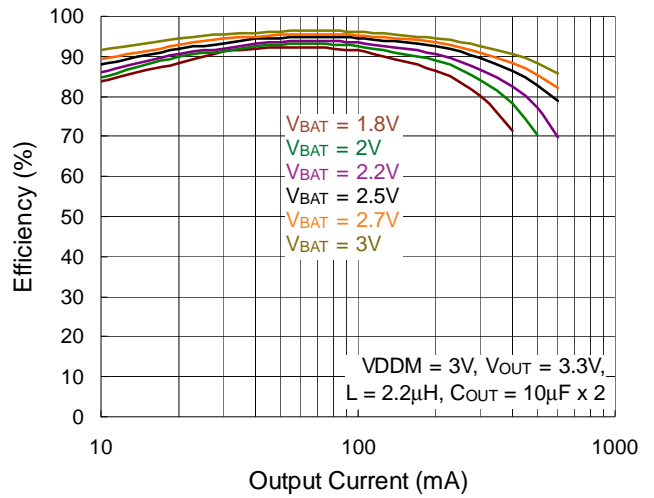

**CH2 Step-Down Efficiency vs. Output Current**

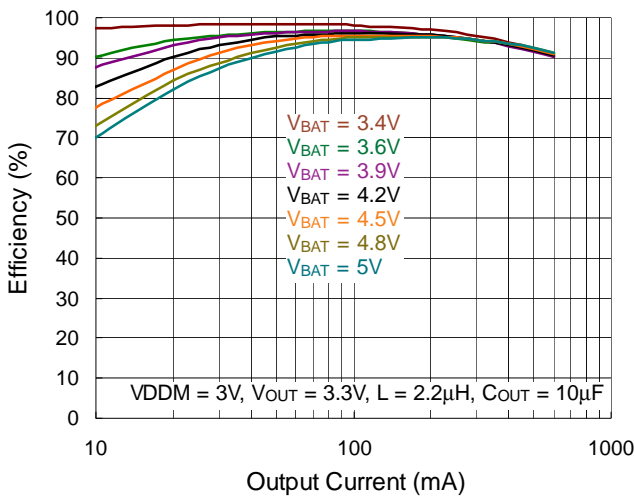

**CH3 Step-Down Efficiency vs. Output Current**

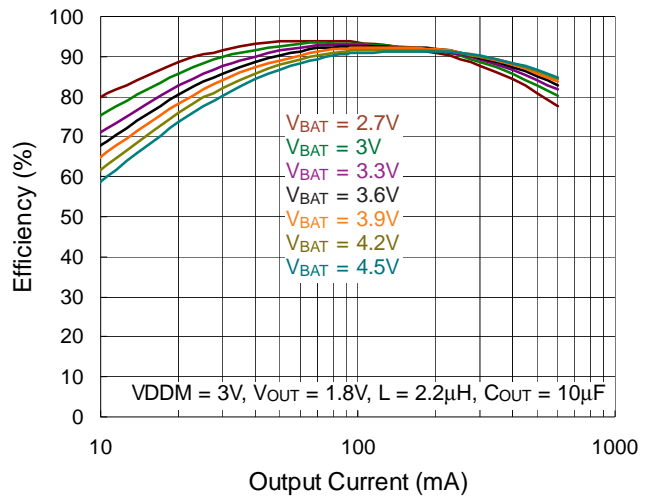

**CH4 Step-Down Efficiency vs. Output Current**

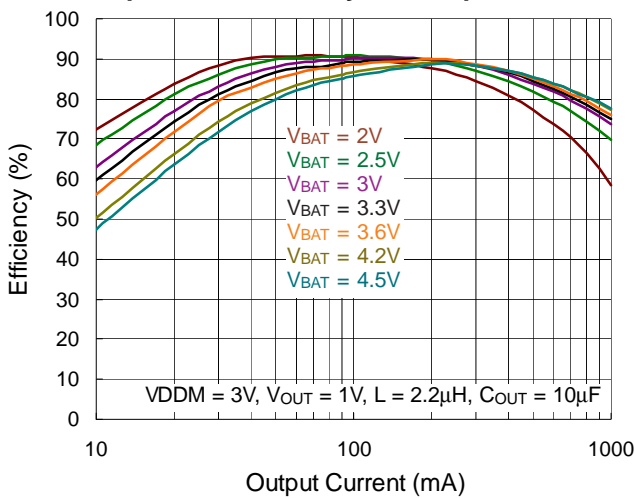

**CH6 Efficiency vs. Input Voltage**

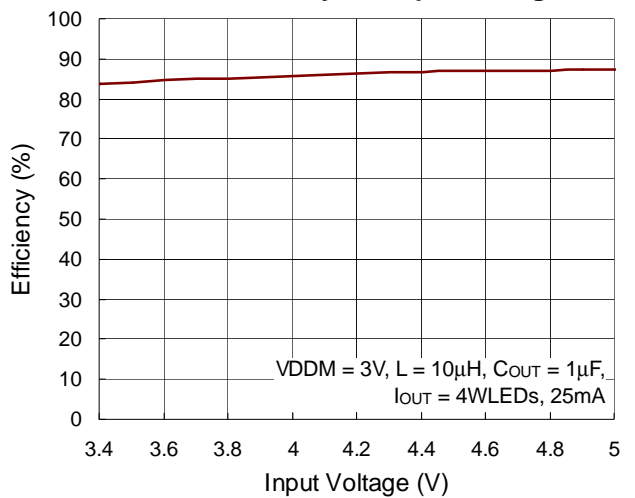

CH1 Step-Up Output Voltage vs. Output Current

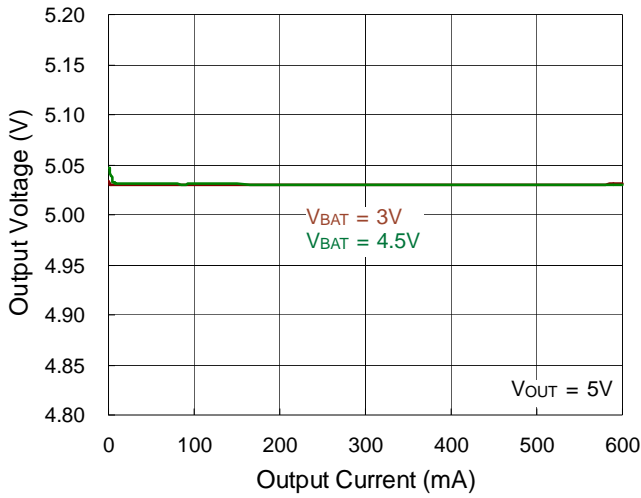

CH2 Step-Dwon Output Voltage vs. Output Current

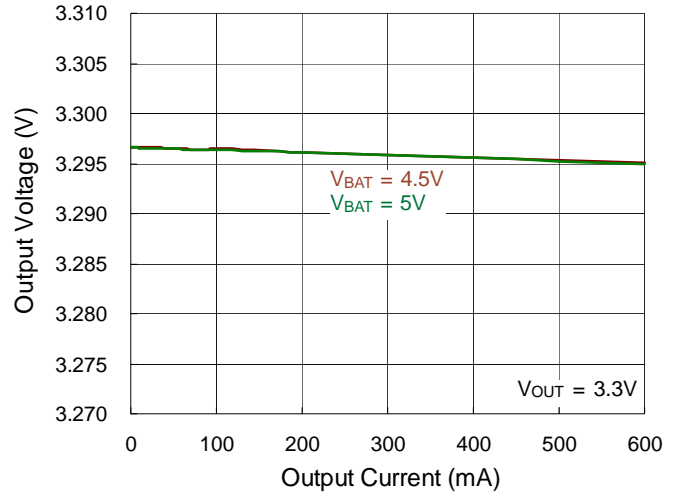

CH3 Step-Down Output Voltage vs. Output Current

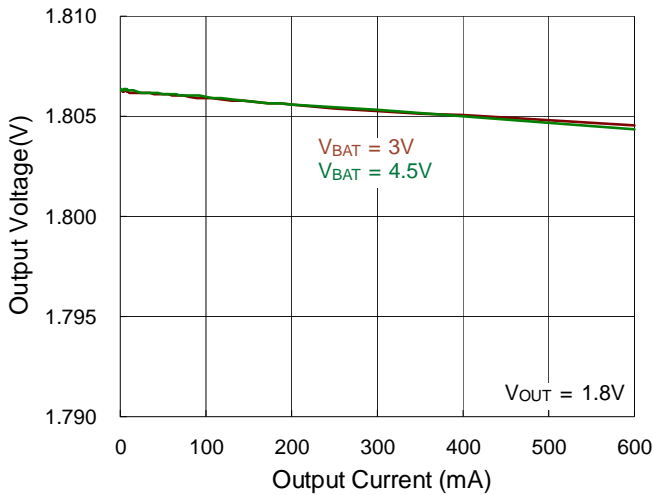

CH4 Step-Down Output Voltage vs. Output Current

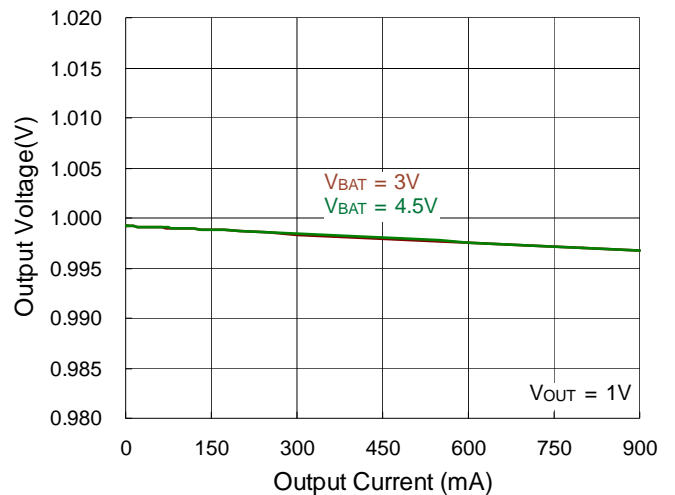

CH5 LDO Output Voltage vs. Output Current

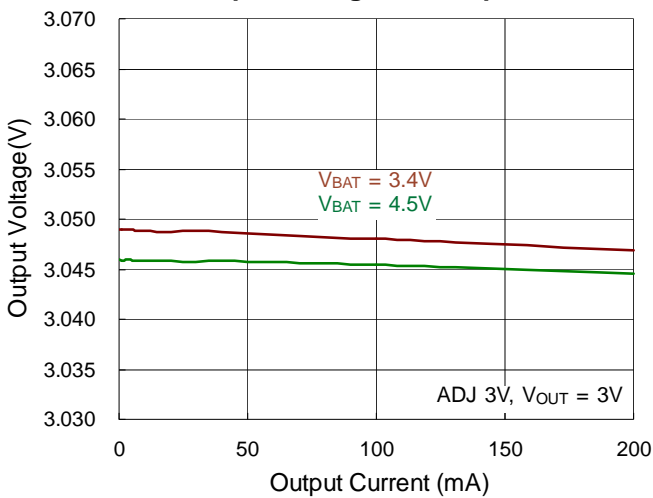

Power On Sequence Independently

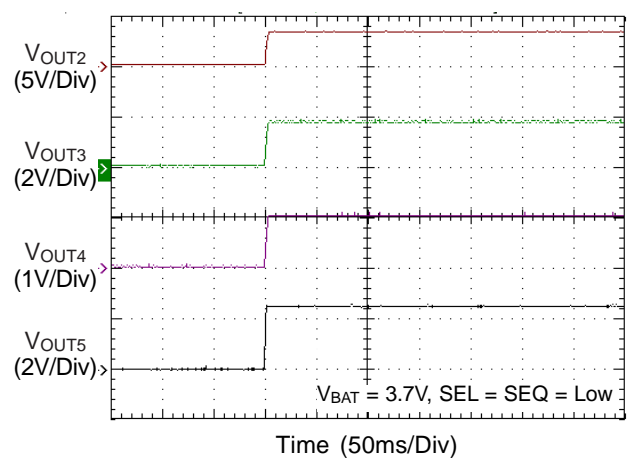

**Power Off Sequence Independently**

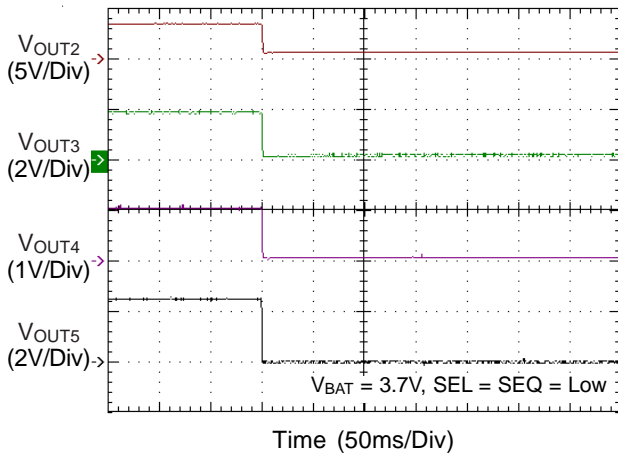

**Power On Sequence 1**

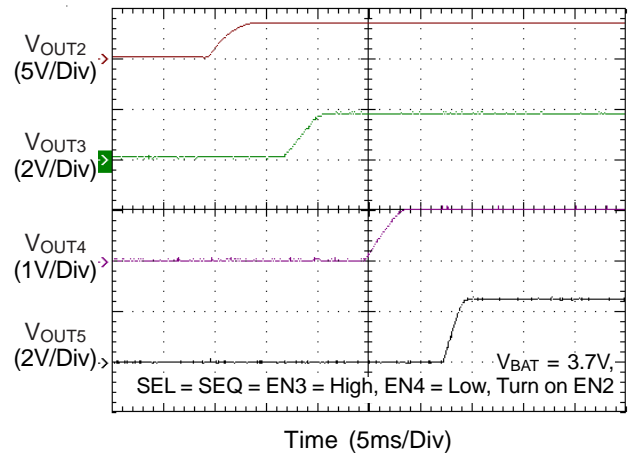

**Power Off Sequence 1**

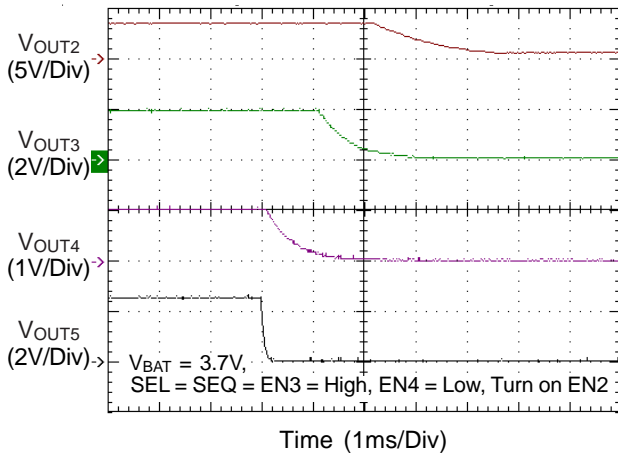

**Power On Sequence 2**

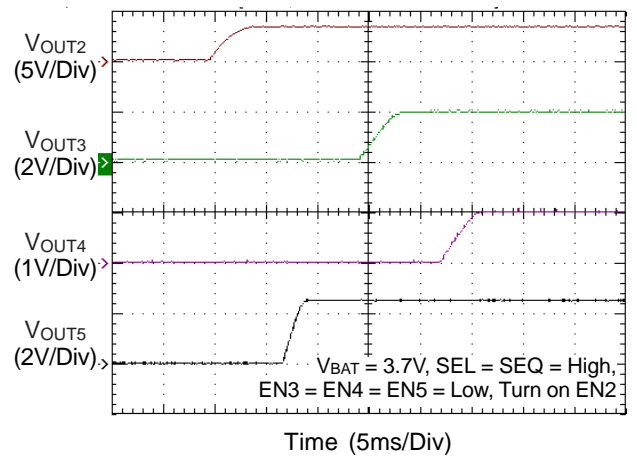

**Power Off Sequence 2**

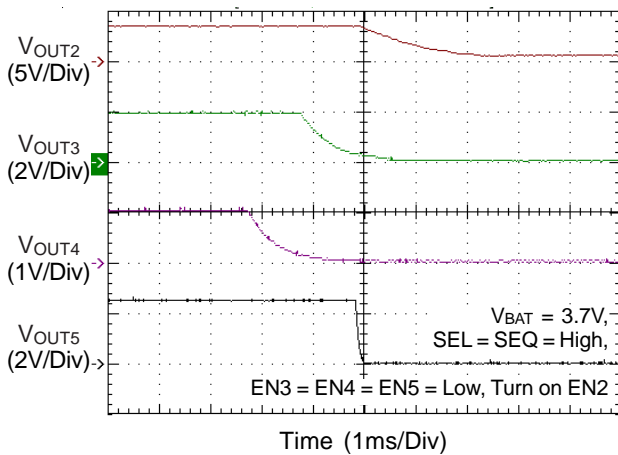

**Power On Sequence 3**

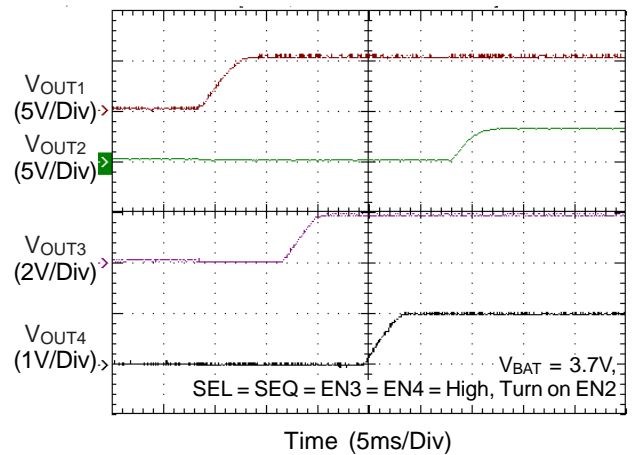

Power Off Sequence 3

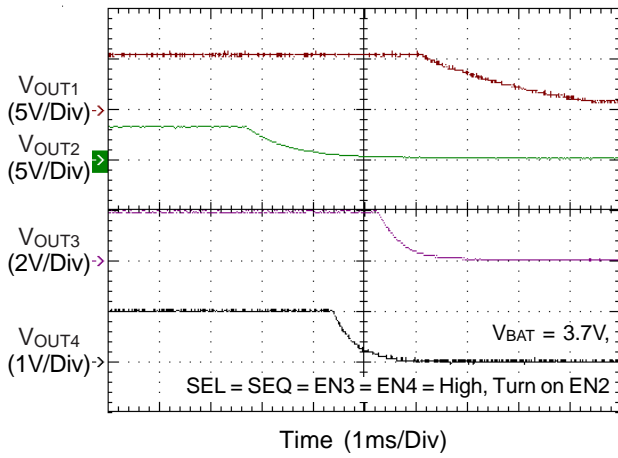

Power On Sequence 4

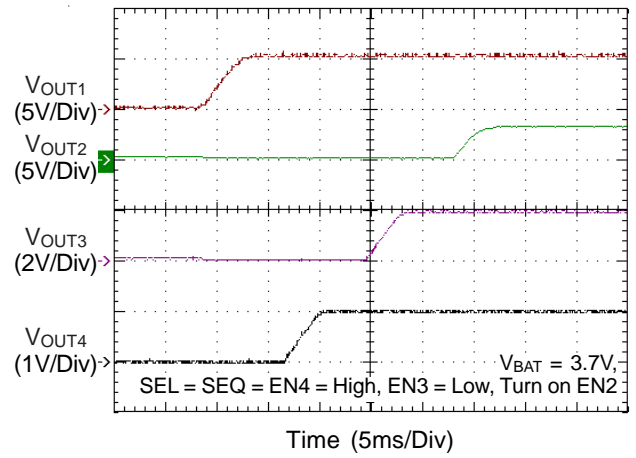

Power Off Sequence 4

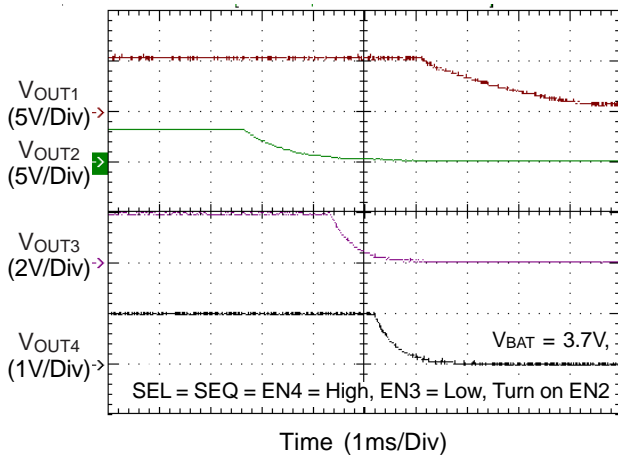

CH1 Output Voltage Ripple

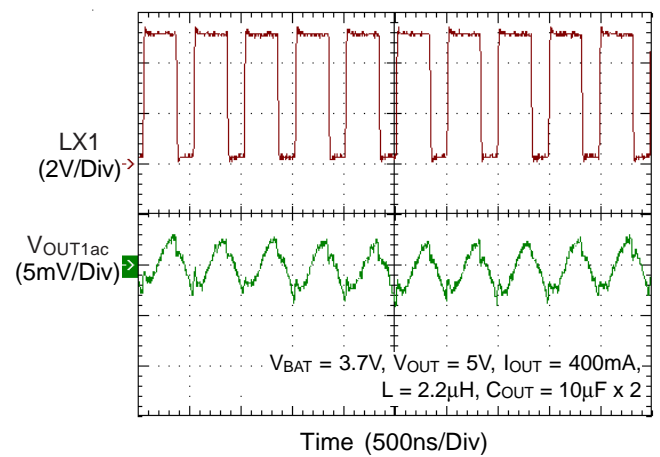

CH2 Output Voltage Ripple

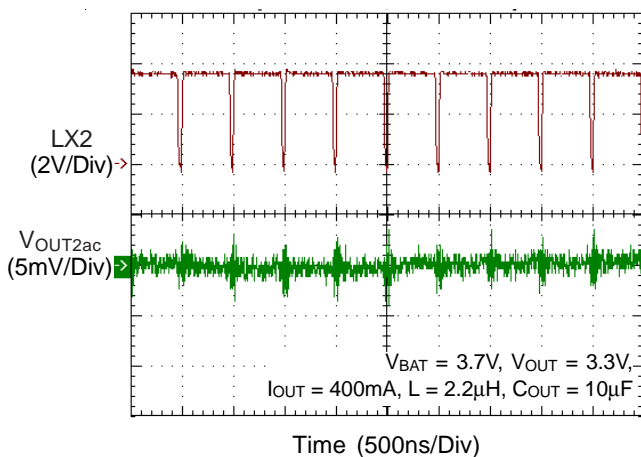

CH3 Output Voltage Ripple

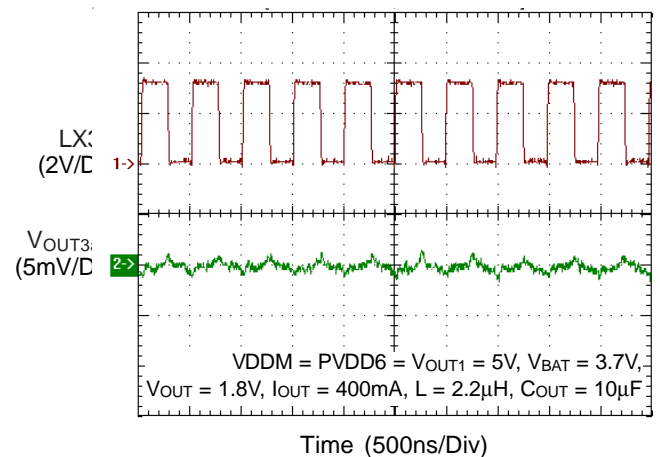

**CH4 Output Voltage Ripple**

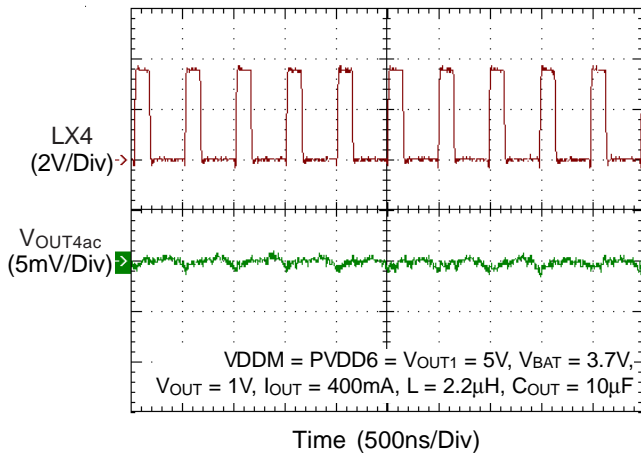

**CH6 Output Voltage Ripple**

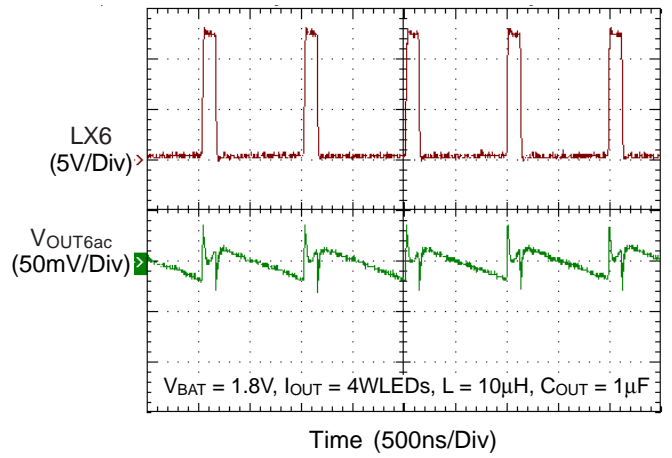

**CH1 Load Transient Response**

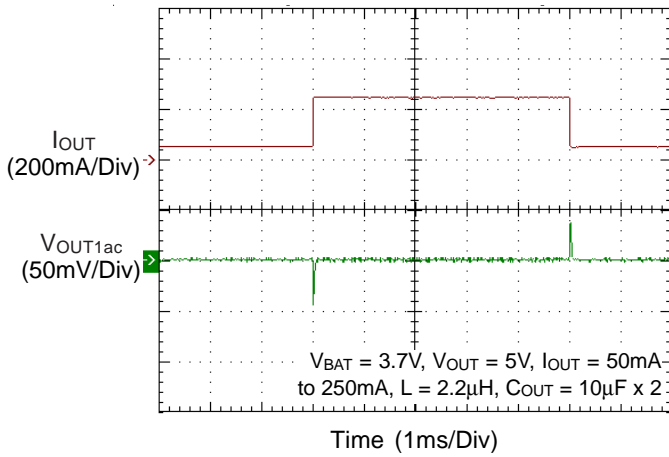

**CH2 Load Transient Response**

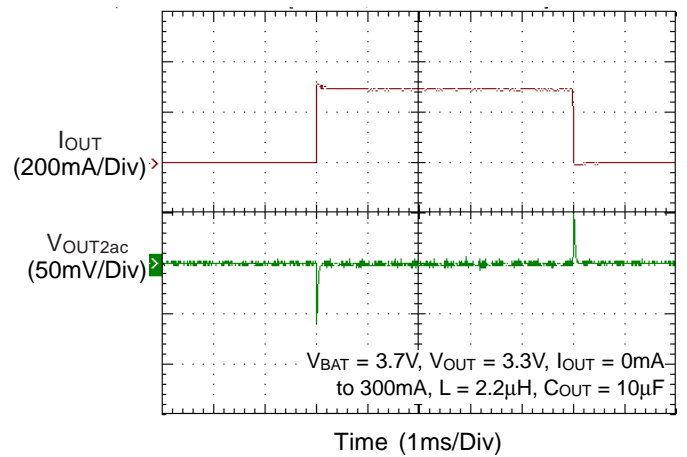

**CH2 Load Transient Response**

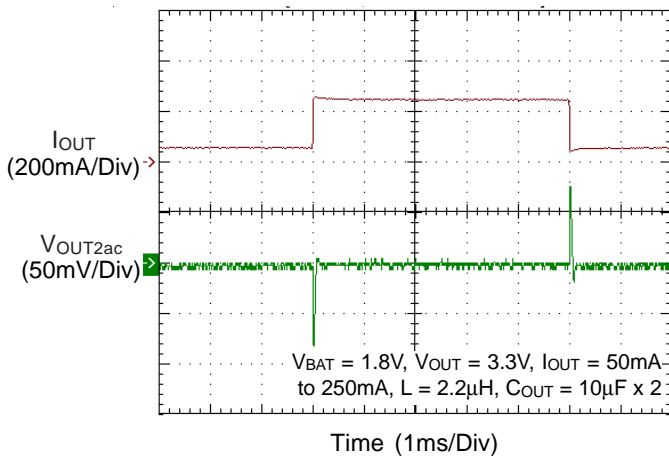

**CH3 Load Transient Response**

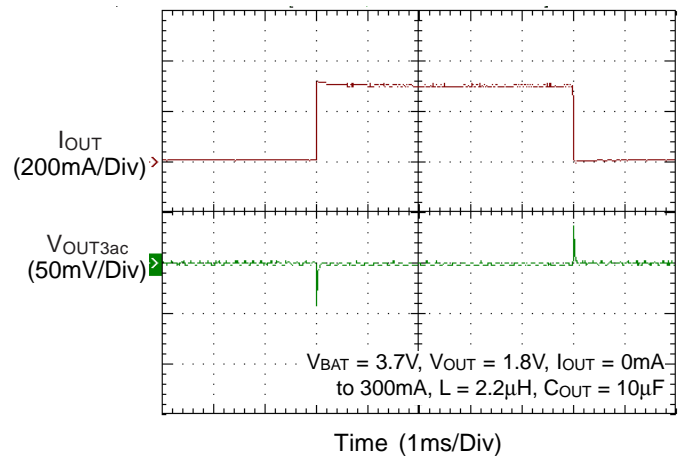

### CH4 Load Transient Response

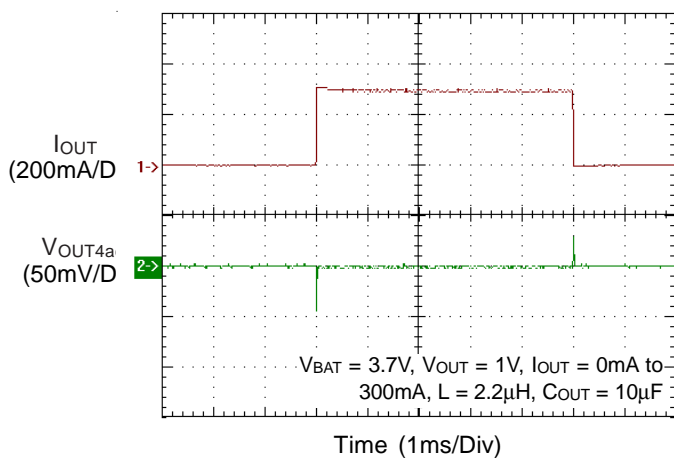

### CH5 Load Transient Response

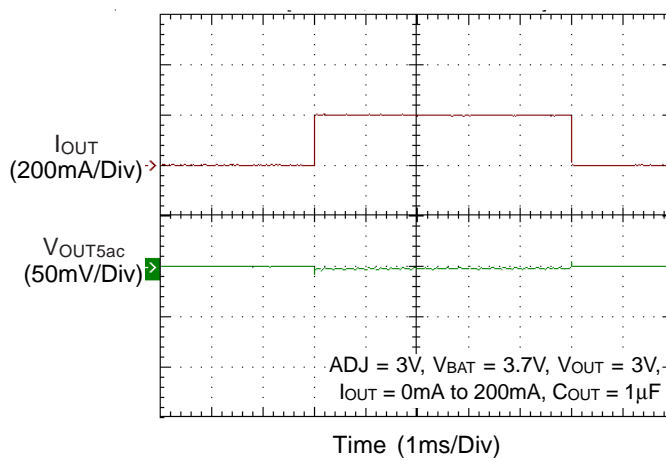

**Application Information**

The RT9992 includes the following four DC/DC converter channels, two LDOs, and one WLED driver to build a multiple-output power-supply system.

CH1 : Step-up synchronous current mode DC/DC converter with internal power MOSFETs and compensation network. The P-MOSFET body can be controlled to disconnect the load.

CH2 : Selectable step-up or step-down synchronous current mode DC/DC converter with internal power MOSFETs and compensation network. The P-MOSFET body can be controlled to disconnect the load.

CH3 : Step-down synchronous current mode DC/DC converter with internal power MOSFETs and internal compensation network.

CH4 : Step-down synchronous current mode DC/DC converter with internal power MOSFETs and internal compensation network.

CH5 : Generic LDO that provides either fixed 2.5V output or adjustable output voltage via external feedback network, depending on initial by FB5 voltage prior to becoming enabled.

CH6 : WLED driver operable in either current source mode or asynchronous step-up mode with internal power MOSFET and compensation network.

CH1 to CH4 operate in PWM mode with 2MHz, while CH6 operates in step-up mode with 1MHz switching frequency under moderate to heavy loading.

RTC\_LDO : 3.1V output LDO with low quiescent current and high output voltage accuracy.

Power Good Indicator : Monitors FB2, FB3, and FB4 status.

**CH1 : Synchronous Step-Up DC/DC Converter**

CH1 is a synchronous step-up converter for motor driver power in DSC system. The converter operates at fixed frequency and under PWM Current Mode. The converter integrates internal MOSFETs, compensation network and synchronous rectifier for up to 95% efficiency. It also disconnects the load when CH1 is turned off. Connect BAT to the power input node in front of CH1 inductor.

The output voltage can be set by the following equation :

$$V_{OUT\_CH1} = (1+R1/R2) \times V_{FB1}$$

where  $V_{FB1}$  is 0.8V typically.

**CH2 : Synchronous Step-Up / Step-Down Selectable DC/DC Converter**

CH2 is a synchronous step-up / step-down selectable converter for system I/O power.

**Mode Setting**

CH2 of the RT9992 features flexible step-up/step-down topology setting for 2AA / Li-ion battery. If CH2 operates in step-up mode, the SEL pin should be connected to GND. If CH2 operates in step-down mode, the SEL pin should be connected to  $V_{BAT}$ . In addition, please note that the logic state can not be changed during operation.

**Table 2. CH2 Mode Setting**

CH2 Operating Mode	Connection
Step-Up	Connect the SEL pin to GND.
Step-Down	Connect the SEL pin to $V_{BAT}$ .

**Step-Up**

The converter operates in fixed frequency PWM Mode, Continuous Current Mode (CCM), and Discontinuous Current Mode (DCM) with internal MOSFETs, compensation network and synchronous rectifier for up to 95% efficiency. In step-up mode, CH2 also disconnects the load when it is turned off. Connect VIN2 to the power input node in front of CH2 inductor.

**Step-Down**

The converter operates in fixed frequency PWM mode and Continuous Current Mode (CCM) with internal MOSFETs, compensation network and synchronous rectifier for up to 95% efficiency. The CH2 step-down converter can be operated at 100% maximum duty cycle to extend the input operating voltage range. When the input voltage is close to the output voltage, the converter enters low dropout mode. In step-down mode, connect the VIN2 pin to GND via a 470kΩ pull-down resistor.

The output voltage can be set by the following equation :

$$V_{OUT\_CH2} = (1+R3/R4) \times V_{FB2}$$

where  $V_{FB2}$  is 0.8V typically

### CH3 : Synchronous Step-Down DC/DC Converter

CH3 is suitable for DRAM power in DSC system. The converter operates in fixed frequency PWM mode and CCM with integrated internal MOSFETs and compensation network. The CH3 step-down converter can be operated at 100% maximum duty cycle to extend battery operating voltage range. When the input voltage is close to the output voltage, the converter enters low dropout mode with low output ripple.

The output voltage can be set by the following equation :

$$V_{OUT\_CH3} = (1 + R5 / R6) \times V_{FB3}$$

where  $V_{FB3}$  is 0.8V typically.

### CH4 : Synchronous Step-Down DC/DC Converter

CH4 is suitable for processor core power in DSC system. The converter operates in fixed frequency PWM mode and CCM with integrated internal MOSFETs and compensation network. The CH4 step-down converter can be operated at 100% maximum duty cycle to extend battery operating voltage range. When the input voltage is close to the output voltage, the converter enters low dropout mode with low output ripple.

The output voltage can be set by the following equation :

$$V_{OUT\_CH4} = (1+R7/R8) \times V_{FB4}$$

Where  $V_{FB4}$  is 0.8V typically.

### CH5 : Generic LDO

The RT9992 provides a generic LDO with high output voltage accuracy. The LDO outputs either a fixed 2.5V voltage or an adjustable voltage with external feedback network, depending on the initial FB5 voltage. The CH5 adjustable output voltage can be set by the following equation :

$$V_{OUT\_CH5} = (1+R11/R12) \times V_{FB5}$$

Where  $V_{FB5}$  is 0.5V typically.

### CH6: WLED Driver

CH6 is a WLED driver that can operate in either current source mode or asynchronous step-up mode, depending

on the initial VOUT6 voltage level. In addition, if CH4 soft-start does not finish, CH6 can not be turned on.

**Table 3. CH6 WLED Setting**

CH6 Operating Mode	VOUT6
Current Source	<0.3V
Asynchronous Step-Up	>0.7V

When CH6 works in current source mode, it sinks an accurate LED current modulated by EN6 high duty such that it is easily dimmed from 0mA to 30mA. If CH6 works in asynchronous step-up mode, it integrates asynchronous step-up mode with an internal MOSFET and internal compensation, and requires an external schottky diode to output a voltage up to 19V. The LED current is set via an external resistor and controlled via the PWM duty on the EN6 pin. Regardless of the mode, holding EN6 low for more than 32.7ms will turn off CH6.

### CH6 WLED Current Dimming Control

If CH6 is in asynchronous step-up mode, the WLED current is set by an external resistor. And the dimming is controlled by the duty of pulse width modulated signal on the EN6 pin.

The average current through WLED can be set by the following equations :

$$I_{LED} \text{ (mA)} = [250\text{mV}/R(\Omega)] \times \text{Duty (\%)} \dots\dots\text{for step-up mode}$$

$$\text{Or } I_{LED} \text{ (mA)} = 30\text{mA} \times \text{Duty (\%)} \dots\dots\text{ for current source mode}$$

R : Current sense resistor from FB6 to GND.

Duty : PWM dimming via the EN6 pin. Dimming frequency range is from 1kHz to 100kHz but 2kHz to 20kHz should be avoided to prevent audio noise distraction.

### VDDM Power Path

To support bootstrap function, the RT9992 includes a power selection circuit which selects between BAT and PVDD6 for the higher voltage to be used as the internal node, VDDI, that connects to the external decoupling capacitor at the VDDM pin. VDDM is the main power for the RT9992 control circuit. VDDI is the power input for the RTC LDO. To bootstrap VDDM, PVDD6 must connect to the output of the first enabled low voltage synchronous step-up channel (CH1 or CH2). Furthermore, PVDD6 also

provides power to the N-MOSFET driver in CH6. The RT9992 includes UVLO circuits to check VDDM and BAT voltage status.

**RTC LDO**

The RT9992 provides a 3.1V output LDO for real time clock. The LDO features low quiescent current (5μA) and high output voltage accuracy. The RTC LDO is always on, even when the system is shut down. For better stability, it is recommended to connect a 0.1μF capacitor to the RTCPWR pin. The RTC LDO includes pass transistor body

diode control to avoid the RTCPWR node from back charging into the input node VDDI.

**Power Good**

The RT9992 provides a power good indicator to monitor FB2, FB3, and FB4 voltage status. After CH2, CH3, and CH4 are turned on, if any one of them becomes lower than 0.66V (typically), PGOOD will be pulled low. If all are higher than 0.7V (typically), PGOOD will be released and pulled high after 10ms.

**Power On/Off Sequence**

SEQ = 0 : CH1 to 5 are independently enabled by EN1 to EN5

SEQ = 1 : CH2 to 5, or CH1 to 4 is enabled in preset on/off sequence. The order is chosen by EN3 and EN4

SEQ	EN2	EN3	EN4	EN5	EN1	Power On Sequence			
0	indept	indept	indept	indept	indept	independent			
1	EN2345	1	0	X	indept	CH2	CH3	CH4	CH5
1	EN2345	0	0	0	indept	CH2	CH5	CH3	CH4
1	EN1234	1	1	indept	x	CH1	CH3	CH4	CH2
1	EN1234	0	1	indept	x	CH1	CH4	CH3	CH2

X : don't care but suggested to be LOW (0).

**Power On/Off Sequence Example for CH2 to CH5**

Sequence 1: SEQ is high, EN3 is high, EN4 is low.

EN2 will turn on/off CH2 to CH5 in preset sequence. CH1 will be turned on by EN1 independently.

CH2 to CH5 Power On Sequence is :

When EN2 goes high, CH2 will be turned on . 7ms after CH2 is turned on, CH3 will be turned on. 7ms after CH3 is turned on, CH4 will be turned on. 7ms after CH4 is turned on, CH5 will be turned on.

CH2 to CH5 Power-Off Sequence is :

When EN2 goes low, CH5 will be turned off and VOUT5 will be internally discharged. When VOUT5 discharging finishes, CH4 will turn off and internally discharge output via LX4 pin. When FB4 < 0.1V, CH3 will turn off and internally discharge output via LX3 pin. Likewise when FB3 < 0.1V, CH2 will turn off and discharge output via LX2 pin. After FB2 < 0.1V, CH2 to 5 shutdown sequence will be completed.

Sequence 2 : SEQ is high, EN3 is low, EN4 is low, EN5 is low.

EN2 will turn on/off CH2 to CH5 in preset sequence. CH1 will be turned on by EN1 independently.

CH2 to CH5 Power On Sequence is :

When EN2 goes high, CH2 will be turned on . 7ms after CH2 is turned on, CH5 will be turned on. About 1ms after Ch5 is turned on, CH3 will be turned on. 7ms after CH3 is turned on, CH4 will be turned on.

CH2 to CH5 Power-Off Sequence is :

When EN2 goes low, CH4 will turn off first and internally discharge output via LX4 pin. When FB4 < 0.1V, CH3 will turn off and internally discharge output via LX3 pin. Likewise, when FB3 < 0.1V, CH5 will turn off and VOUT5 will be internally discharged. When VOUT5 discharging finishes, CH2 will turn off and discharge output via LX2 pin. After FB2 < 0.1V, CH2 to 5 shut down sequence will be completed.

Table 4. CH2 to CH5 Power On/Off Sequence

EN3 to EN5 Setting	Power On Sequence
EN3 = H, EN4 = L, EN5 = X	CH2→CH3→CH4→CH5
EN3 = L, EN4 = L, EN5 = L	CH2→CH5→CH3→CH4
EN3 to EN5 Setting	Power Off Sequence
EN3 = H, EN4 = L, EN5 = X	CH5→CH4→CH3→CH2
EN3 = L, EN4 = L, EN5 = L	CH4→CH3→CH5→CH2

**Timing Diagram for CH2 to CH5**

Power On Sequence : CH2 Step-Down 3.3V→CH3 Step-Down 1.8V→CH4 Step-Down 1.2V→CH5 LDO 2.5V

Power Off Sequence : CH5 LDO 2.5V→CH4 Step-Down 1.2V→CH3 Step-Down 1.8V→CH2 Step-Down 3.3V

SEL = H, SEQ = H, EN3 = H, EN4 = L

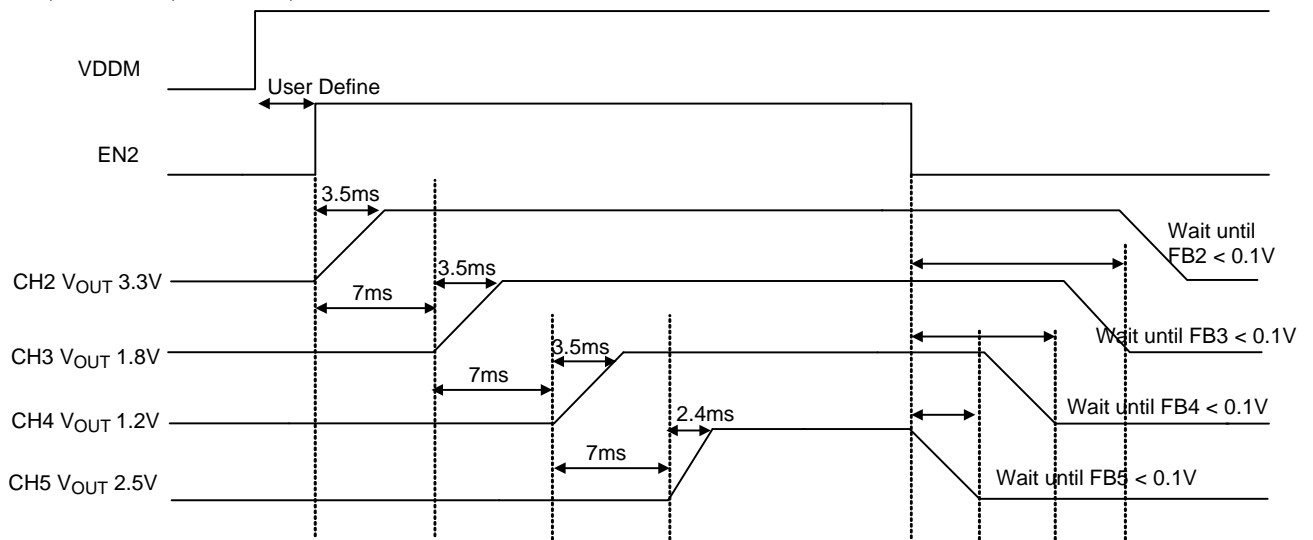

Power On Sequence : CH5 LDO 2.5V→CH3 Step-Down 1.8V→CH4 Step-Down 1.2V

Power Off Sequence : CH4 Step-Down 1.2V→CH3 Step-Down 1.8V→CH5 LDO 2.5V→CH2 Step-Down 3.3V

SEL = H, SEQ = H, EN3 = L, EN4 = L, EN5 = L

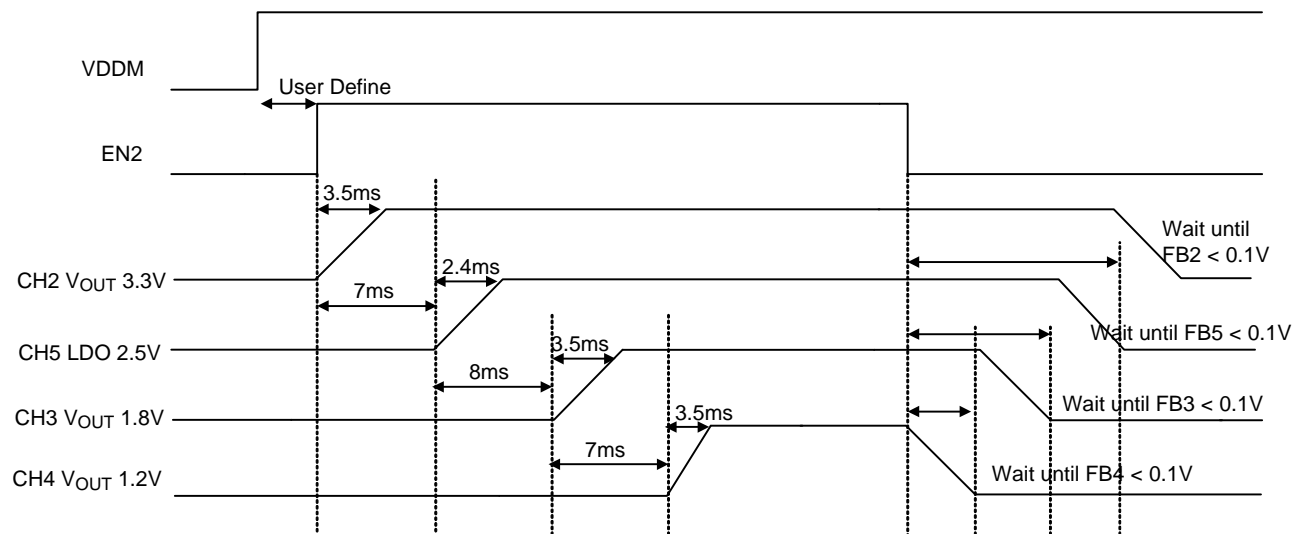

**Power on/off sequence for CH1 to CH4**

Sequence 3 : SEQ is high, EN3 is high, EN4 is high.

EN2 will turn on/off CH1 to CH4 in preset sequence. CH5 will be turned on by EN5 independently.

CH1 to CH4 Power On Sequence is :

When EN2 goes high, CH1 will be turned on. 7ms after CH1 is turned on, CH3 will be turned on. 7ms after CH3 is turned on, CH4 will be turned on. 7ms after CH4 is turned on, CH2 will be turned on.

CH1 to CH4 Power-Off Sequence is :

When EN2 goes low, CH2 will turn off first and internally discharge output. When FB2 < 0.1V, CH4 will turn off and also internally discharge output via LX4 pin. When FB4 < 0.1V, CH3 will turn off and internally discharge output via LX3 pin. Likewise, when FB3 < 0.1V, CH1 will turn off and discharge output via LX1 pin. After FB1 < 0.1V, CH1 to 4 shutdown sequence will be completed.

Sequence 4 : SEQ is high, EN3 is low, EN4 is high.

EN2 will turn on/off CH1 to CH4 in preset sequence. CH5 will be turned on by EN5 independently.

CH1 to CH4 Power On Sequence is :

When EN2 goes high, CH1 will be turned on first. 7ms after CH1 is turned on, CH4 will be turned on. 7ms after CH4 is turned on, CH3 will be turned on. 7ms after CH3 is turned on, CH2 will be turned on.

CH1 to CH4 Power Off Sequence is :

When EN2 goes low, CH2 will turn off first and internally discharge output. When FB2 < 0.1V, CH3 will turn off and internally discharge output via LX3 pin. When FB3 < 0.1V, CH4 will turn off and internally discharge output via LX4 pin. Likewise when FB4 < 0.1V, CH1 will turn off and internally discharge output via LX1 pin. After FB1 < 0.1V, Ch1 to 4 shutdown sequence is completed.

**Table 5. CH1 to CH4 Power On/Off Sequence**

Enable Setting	Power On Sequence
EN3 = H, EN4 = H, EN1 = X	CH1→CH3→CH4→CH2
EN3 = L, EN4 = H, EN5 = X	CH1→CH4→CH3→CH2
Enable Setting	Power Off Sequence
EN3 = H, EN4 = H, EN5 = X	CH2→CH4→CH3→CH1
EN3 = L, EN4 = H, EN5 = X	CH2→CH3→CH4→CH1

**Timing Diagram for CH1 to CH4**

Power On Sequence : CH1 Step-Up 5V→CH3 Step-Down 1.8V→CH4 Step-Down 1.2V →CH2 Step-Up 3.3V

Power Off Sequence : CH2 Step-Up 3.3V→CH4 Step-Down 1.2V→CH3 Step-Down 1.8V→CH1 Step-Up 5V

SEL = L, SEQ = H, EN3 = H, EN4 = H

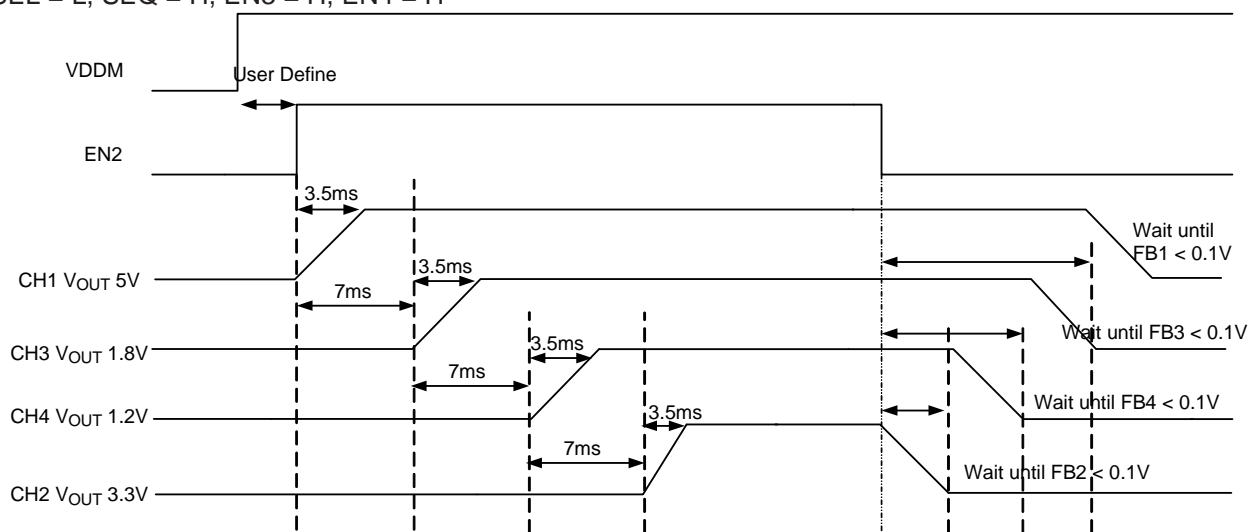

Power On Sequence : CH1 Step-Up 5V →CH4 Step-Down 1.2V→CH3 Step-Down 1.8V→CH2 Step-Up 3.3V  
 Power Off Sequence : CH2 Step-Up 3.3V→CH3 Step-Down 1.8V→CH4 Step-Down 1.2V →CH1 Step-Up 5V  
 SEL = L, SEQ = H, EN3 = L, EN4 = H

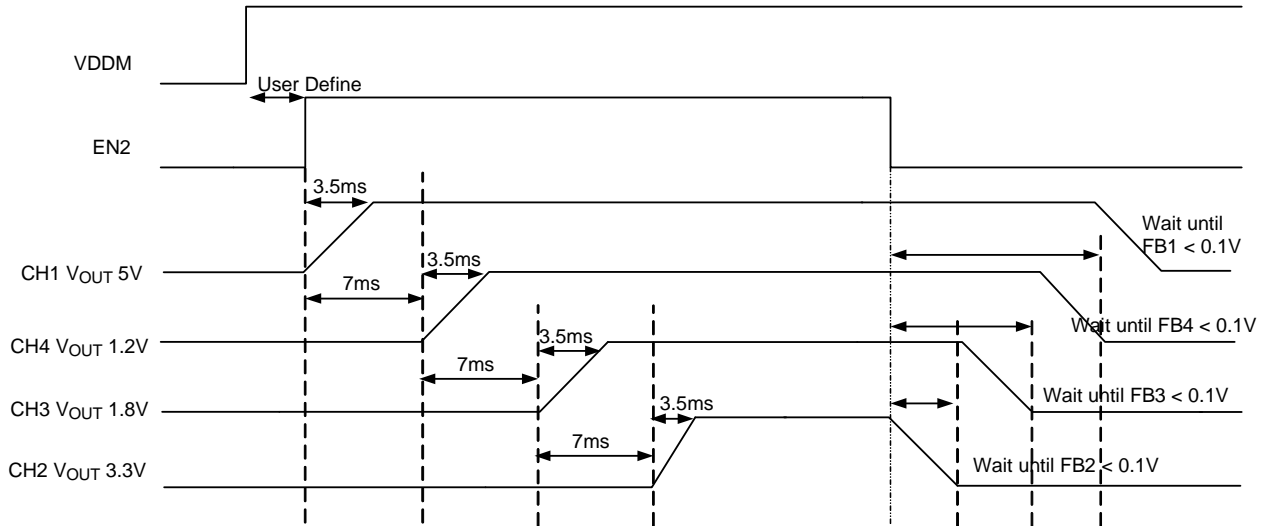

### Thermal Considerations

For continuous operation, do not exceed absolute maximum junction temperature. The maximum power dissipation depends on the thermal resistance of the IC package, PCB layout, rate of surrounding airflow, and difference between junction and ambient temperature. The maximum power dissipation can be calculated by the following formula :

$$P_{D(MAX)} = (T_{J(MAX)} - T_A) / \theta_{JA}$$

where  $T_{J(MAX)}$  is the maximum junction temperature,  $T_A$  is the ambient temperature, and  $\theta_{JA}$  is the junction to ambient thermal resistance.

For recommended operating condition specifications of the RT9992, the maximum junction temperature is 125°C and  $T_A$  is the ambient temperature. The junction to ambient thermal resistance,  $\theta_{JA}$ , is layout dependent. For WQFN-32L 4x4 packages, the thermal resistance,  $\theta_{JA}$ , is 27.8°C/W on a standard JEDEC 51-7 four-layer thermal test board. The maximum power dissipation at  $T_A = 25^\circ\text{C}$  can be calculated by the following formula :

$$P_{D(MAX)} = (125^\circ\text{C} - 25^\circ\text{C}) / (27.8^\circ\text{C/W}) = 3.59\text{W for WQFN-32L 4x4 package}$$

The maximum power dissipation depends on the operating ambient temperature for fixed  $T_{J(MAX)}$  and thermal resistance,  $\theta_{JA}$ . For the RT9992 package, the derating curve in Figure 1 allows the designer to see the effect of rising ambient temperature on the maximum power dissipation.

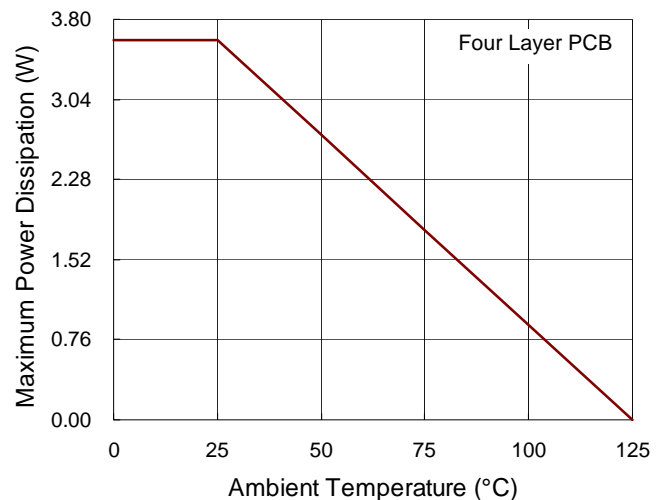

Figure 1. Derating Curve for the RT9992 Package

**Layout Considerations**

For the best performance of the RT9992, the following PCB layout guidelines must be strictly followed.

- ▶ Place the input and output capacitors as close as possible to the input and output pins respectively for good filtering.
- ▶ Keep the main power traces as wide and short as possible.
- ▶ The switching node area connected to LX and inductor should be minimized for lower EMI.
- ▶ Place the feedback components as close as possible to the FB pin and keep these components away from the noisy devices.
- ▶ Connect the GND and Exposed Pad to a strong ground plane for maximum thermal dissipation and noise protection.
- ▶ Directly connect the output capacitors to the feedback network of each channel to avoid bouncing caused by parasitic resistance and inductance from the PCB trace.

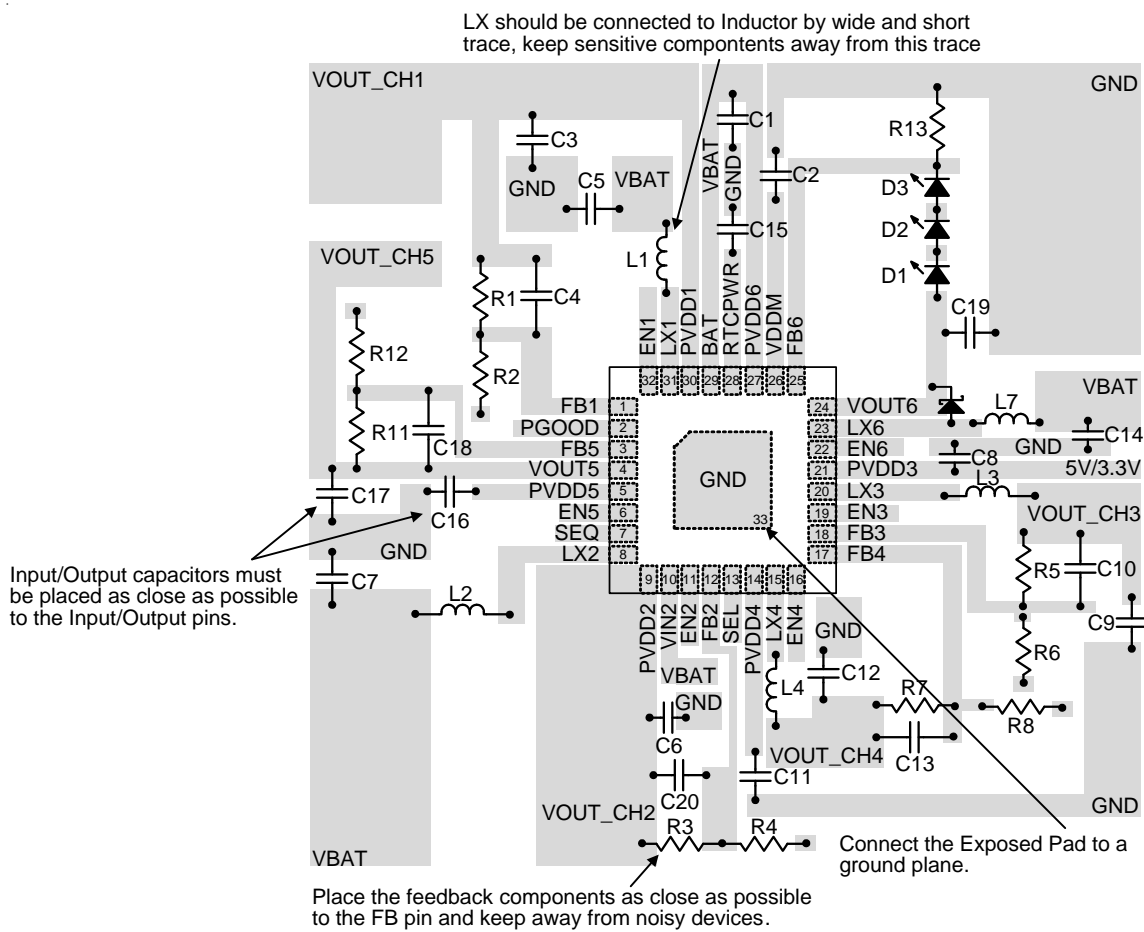
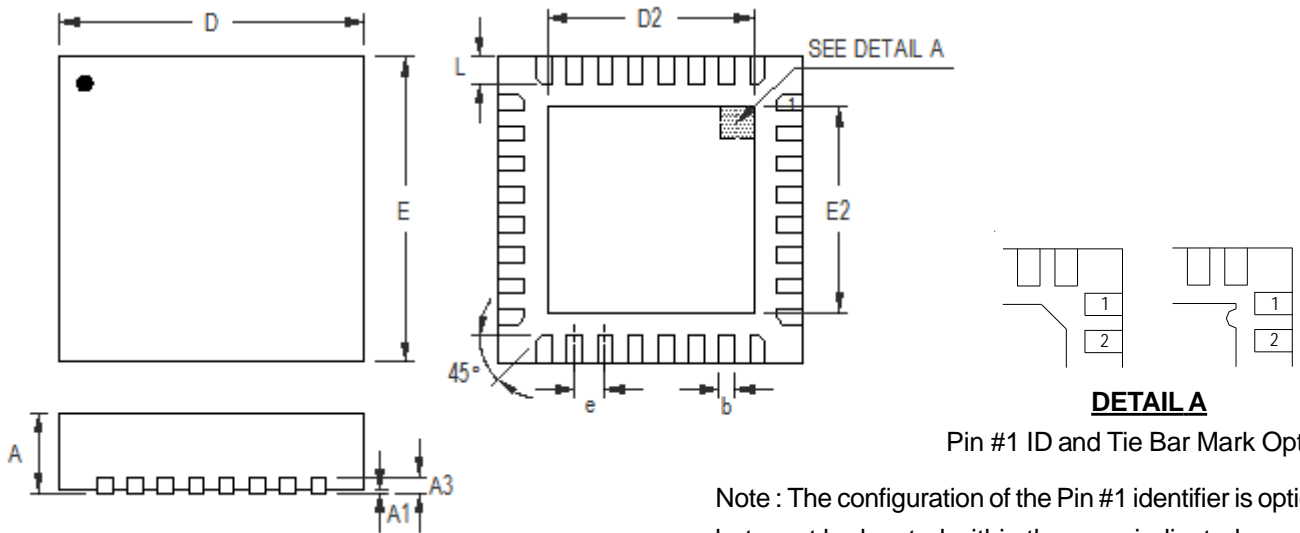

Figure 2. PCB Layout Guide

Table 6. Protection Action

	Protection Type	Threshold(typical) Refer to Electrical spec	Delay Time	Protection Methods
V <sub>DDM</sub>	UVLO	V <sub>DDM</sub> < 2.1V	No delay	Disable all channels
	OVP	V <sub>DDM</sub> > 6.15V	100ms	IC shutdown
BAT	UVLO	V <sub>BAT</sub> < 1.3V	No delay	Disable all channels
CH1 : Boost	Current Limit	N-MOSFET current > 3A	100ms	IC shutdown
	PVDD1 UVP	V <sub>FB1</sub> < 0.4V, or V <sub>PVDD1</sub> < V <sub>BAT</sub> -0.8V or V <sub>PVDD1</sub> < 1.3V	100ms	IC shutdown
	PVDD1 OVP	V <sub>PVDD1</sub> > 6.15V	No delay	IC shutdown
CH2 : Boost	Current Limit	N-MOSFET current > 2.1A	100ms	IC shutdown
	PVDD2 UVP	V <sub>FB2</sub> < 0.4V, or V <sub>PVDD2</sub> < V <sub>IN2</sub> - 0.8V or V <sub>PVDD2</sub> < 1.3V	100ms	IC shutdown
	PVDD2 OVP	V <sub>PVDD2</sub> > 6.15V	No delay	IC shutdown
CH2 : Buck	OCP	P-MOSFET current > 1.5A	100ms	IC shutdown
	UVP	V <sub>FB2</sub> < 0.4V	100ms	IC shutdown
CH3 : Buck	OCP	P-MOSFET current > 1.5A	100ms	IC shutdown
	UVP	V <sub>FB3</sub> < 0.4V	100ms	IC shutdown
CH4 : Buck	OCP	P-MOSFET current > 2A	100ms	IC shutdown
	UVP	V <sub>FB4</sub> < 0.4V	100ms	IC shutdown
CH5	Current Limit	P-MOSFET current > 0.38A	100ms	IC shutdown
	UVP	V <sub>FB5</sub> < 0.3V	100ms	IC shutdown
CH6 Asyn Boost	Current Limit	N-MOSFET current > 0.8A	Reset each cycle	
	OVP	V <sub>OUT6</sub> > 19.5V	No delay	Shut down CH6 only
Thermal	Thermal shutdown	Temperature > 160°C	No delay	All channels stop switching

**Outline Dimension**



Pin #1 ID and Tie Bar Mark Options

Note : The configuration of the Pin #1 identifier is optional, but must be located within the zone indicated.

Symbol	Dimensions In Millimeters		Dimensions In Inches	
	Min	Max	Min	Max
A	0.700	0.800	0.028	0.031
A1	0.000	0.050	0.000	0.002
A3	0.175	0.250	0.007	0.010
b	0.150	0.250	0.006	0.010
D	3.900	4.100	0.154	0.161
D2	2.650	2.750	0.104	0.108
E	3.900	4.100	0.154	0.161
E2	2.650	2.750	0.104	0.108
e	0.400		0.016	
L	0.300	0.400	0.012	0.016

**W-Type 32L QFN 4x4 Package**



**Richtek Technology Corporation**

14F, No. 8, Tai Yuen 1<sup>st</sup> Street, Chupei City  
 Hsinchu, Taiwan, R.O.C.  
 Tel: (8863)5526789

Richtek products are sold by description only. Richtek reserves the right to change the circuitry and/or specifications without notice at any time. Customers should obtain the latest relevant information and data sheets before placing orders and should verify that such information is current and complete. Richtek cannot assume responsibility for use of any circuitry other than circuitry entirely embodied in a Richtek product. Information furnished by Richtek is believed to be accurate and reliable. However, no responsibility is assumed by Richtek or its subsidiaries for its use; nor for any infringements of patents or other rights of third parties which may result from its use. No license is granted by implication or otherwise under any patent or patent rights of Richtek or its subsidiaries.

## Looking for pricing, stock, or lifecycle information?

Click below to explore more details on WIN SOURCE:

-  [View RT9992ZQW on WIN SOURCE](#)
-  [Richtek USA Inc. Information](#)

## Optimize Your Supply Chain with WIN SOURCE Solutions

-  Global Sourcing Solution
-  Obsolete Management
-  Cost Control Management
-  Shortage Management
-  Alternative Solution
-  Excess Inventory Management