

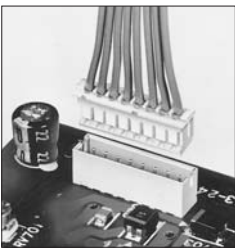

**THE DATASHEET OF
S7B-ZR-SM4A-TF(LF)(SN)**





ZH CONNECTOR

1.5mm pitch/Disconnectable Crimp style connectors

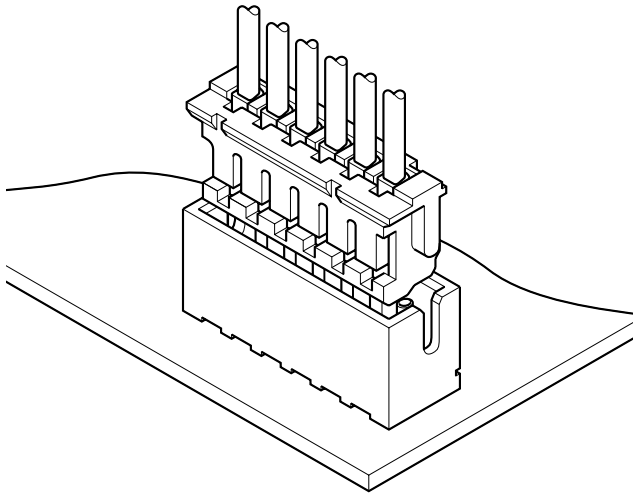

The ZH connector is very small with a mounting height of 5.6 mm and a thickness of only 3.5 mm. Contact retention lances on the housing make insertion easier, while the dimple at the center of the contact ensures reliable contact with the post.

- Compact, low profile design
- Housing lances
- Reliable contact construction
- Distortion resistant construction
- Compatible with the ZR insulation displacement connectors

Specifications

- Current rating: 1.0 A AC, DC (AWG #26)
 - Voltage rating: 50 V AC, DC
 - Temperature range: -25°C to +85°C
(including temperature rise in applying electrical current)
 - Contact resistance: Initial value/ 20 mΩ max.
After environmental tests/ 30 mΩ max.
 - Insulation resistance: 500 MΩ min.
 - Withstanding voltage: 500 VAC/minute
 - Applicable wire: AWG #32 to #26
 - Applicable PC board thickness: 0.6 to 1.2 mm, 1.6 mm
- * Refer to "General Instruction and Notice when using Terminals and Connectors" at the end of this catalog.
* Contact JST for details.
* Compliant with RoHS.

Standards

- Ⓜ Recognized E60389
- Ⓢ Certified LR20812

PC board layout and Assembly layout

<Through-hole type (viewed from soldering side) >

Top entry type

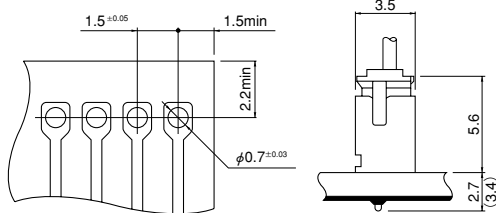

Side entry type

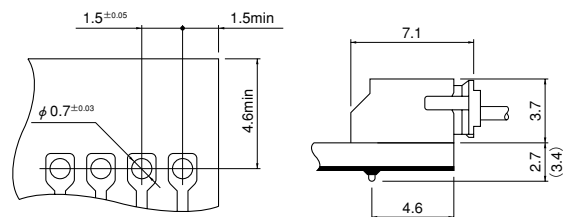

Note: 1. Tolerances are non-cumulative: ±0.05 mm for all centers.

2. Hole dimension differ according to the type of PC board and piercing method. If PC boards made of hard material are used, the hole dimensions should be larger. The dimensions above should serve as a guideline. Contact JST for details.

<SMT type (viewed from component side) >

SM2 type

Side entry type

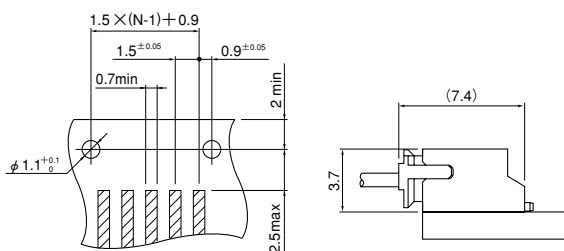

SM4 type

Top entry type

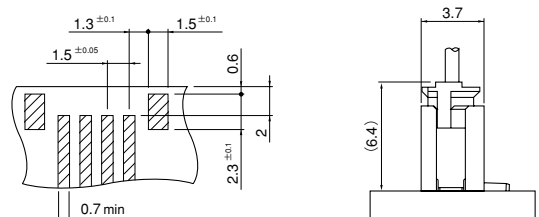

Side entry type

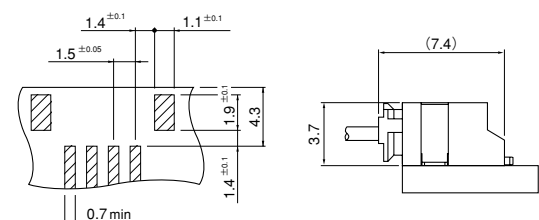

Note: 1. N...Number of circuits

2. Tolerances are non-cumulative: ±0.05 mm for all centers.

3. The dimensions above should serve as a guideline. Contact JST for details.

ZH CONNECTOR

Contact

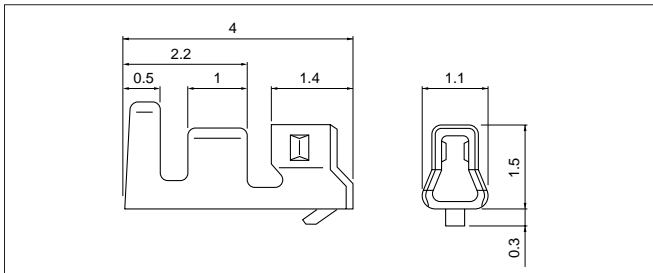

| Contact | Crimping machine | Applicator | | |
|---------------|------------------|------------------|---------------|----------------------------|
| | | Crimp applicator | Dies | Crimp applicator with dies |
| SZH-002T-P0.5 | AP-K2N | MKS-L | MK/SZH-002-05 | APLMK SZH002-05 |

Note: *Strip-crimp applicator.

| Model No. | Applicable wire | | | Q'ty/ reel |
|---------------|-----------------|-------|----------------------|------------|
| | mm ² | AWG# | Insulation O.D. (mm) | |
| SZH-002T-P0.5 | 0.08 ~0.13 | 28~26 | 0.8~1.1 | 13,000 |
| SZH-003T-P0.5 | 0.032~0.08 | 32~28 | 0.5~0.9 | 16,000 |

Material and Finish

Phosphor bronze, tin-plated (reflow treatment)

RoHS compliance

| Contact | Crimping machine | Applicator | | |
|---------------|------------------|------------------|---------------|----------------------------|
| | | Crimp applicator | Dies | Crimp applicator with dies |
| SZH-003T-P0.5 | AP-K2N | MKS-L | MK/SZH-003-05 | APLMK SZH003-05 |
| | | *MKS-SC | SC/SZH-003-05 | APLSC SZH003-05 |

Housing

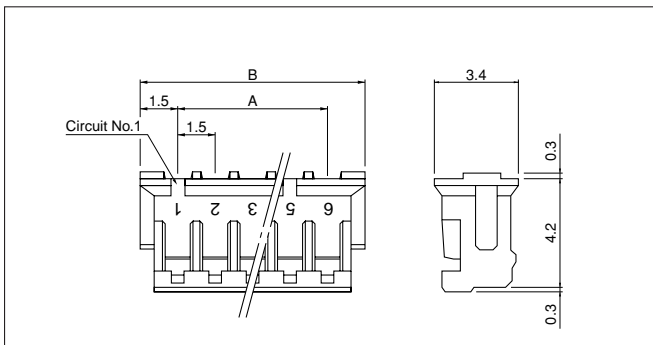

<For reference> As the color identification, the following alphabet shall be put in the underlined part. For availability, delivery and minimum order quantity, contact JST.

ex. **ZHR-2-oo**

(blank)...natural (white)

K...black R...red E...blue M...green L...lemon yellow
LE...light blue DO...dark orange H...gray

| Circuits | Model No. | Dimensions (mm) | | Q'ty/ bag |
|----------|------------|-----------------|------|-----------|
| | | A | B | |
| 2 | ZHR-2 | 1.5 | 4.5 | 1,000 |
| 3 | ZHR-3 | 3.0 | 6.0 | 1,000 |
| 4 | ZHR-4 | 4.5 | 7.5 | 1,000 |
| 5 | ZHR-5 | 6.0 | 9.0 | 1,000 |
| 6 | ZHR-6 | 7.5 | 10.5 | 1,000 |
| 6 | ZHR-6(3.0) | 15.0 | 18.0 | 1,000 |
| 7 | ZHR-7 | 9.0 | 12.0 | 1,000 |
| 8 | ZHR-8 | 10.5 | 13.5 | 1,000 |
| 9 | ZHR-9 | 12.0 | 15.0 | 1,000 |
| 10 | ZHR-10 | 13.5 | 16.5 | 1,000 |
| 11 | ZHR-11 | 15.0 | 18.0 | 1,000 |
| 12 | ZHR-12 | 16.5 | 19.5 | 1,000 |
| 13 | ZHR-13 | 18.0 | 21.0 | 1,000 |

Material

PA 66, UL94V-0, natural (white)

RoHS compliance

Note: 1. ZHR-6(3.0) is 6 circuits 3.0 mm pitch plugged up.
As for this housing, only circuit No.1 is marked.
2. ZHR-6(3.0) is not UL/CSA approved.

Through-hole type shrouded header

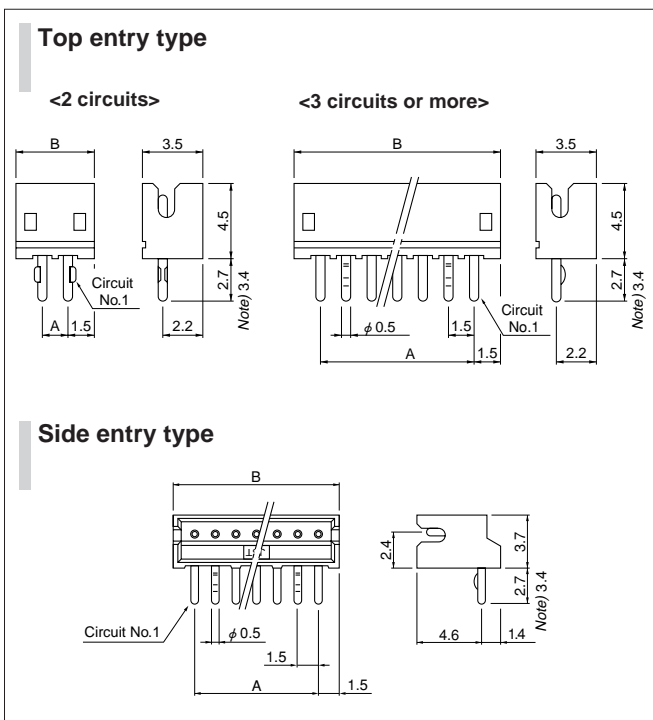

| Circuits | Model No. | | | | Dimensions (mm) | | Q'ty/box | | |
|----------|----------------|-----------------|----------------------|-----------------------|-----------------|------|----------------|-----------------|---------------------|
| | Top entry type | Side entry type | Note) Top entry type | Note) Side entry type | A | B | Top entry type | Side entry type | Side entry type-3.4 |
| 2 | B2B-ZR | S2B-ZR | B2B-ZR-3.4 | S2B-ZR-3.4 | 1.5 | 4.5 | 2,000 | 2,000 | 2,000 |
| 3 | B3B-ZR | S3B-ZR | B3B-ZR-3.4 | S3B-ZR-3.4 | 3.0 | 6.0 | 2,000 | 2,000 | 1,000 |
| 4 | B4B-ZR | S4B-ZR | B4B-ZR-3.4 | S4B-ZR-3.4 | 4.5 | 7.5 | 2,000 | 2,000 | 2,000 |
| 5 | B5B-ZR | S5B-ZR | B5B-ZR-3.4 | S5B-ZR-3.4 | 6.0 | 9.0 | 2,000 | 1,000 | 1,000 |
| 6 | B6B-ZR | S6B-ZR | B6B-ZR-3.4 | S6B-ZR-3.4 | 7.5 | 10.5 | 2,000 | 1,000 | 1,000 |
| 7 | B7B-ZR | S7B-ZR | B7B-ZR-3.4 | S7B-ZR-3.4 | 9.0 | 12.0 | 1,000 | 1,000 | 1,000 |
| 8 | B8B-ZR | S8B-ZR | B8B-ZR-3.4 | S8B-ZR-3.4 | 10.5 | 13.5 | 1,000 | 1,000 | 1,000 |
| 9 | B9B-ZR | S9B-ZR | B9B-ZR-3.4 | S9B-ZR-3.4 | 12.0 | 15.0 | 1,000 | 1,000 | 1,000 |
| 10 | B10B-ZR | S10B-ZR | B10B-ZR-3.4 | S10B-ZR-3.4 | 13.5 | 16.5 | 1,000 | 1,000 | 1,000 |
| 11 | B11B-ZR | S11B-ZR | B11B-ZR-3.4 | S11B-ZR-3.4 | 15.0 | 18.0 | 1,000 | 500 | 500 |
| 12 | B12B-ZR | S12B-ZR | B12B-ZR-3.4 | S12B-ZR-3.4 | 16.5 | 19.5 | 1,000 | 500 | 500 |
| 13 | B13B-ZR | S13B-ZR | B13B-ZR-3.4 | S13B-ZR-3.4 | 18.0 | 21.0 | 500 | 500 | 500 |

Material and Finish

Pin: Brass, copper-undercoated, tin-plated (reflow treatment)
Wafer: Glass-filled PA 66, UL94V-0, natural (ivory)

RoHS compliance

This product displays (LF)(SN) on a label.
Note: Headers with 3.4 mm long solder tails, suited for the 1.6 mm thick PC board.

<For reference> As the color identification, the following alphabet shall be put in the underlined part. For availability, delivery and minimum order quantity, contact JST.

ex. **B2B-ZR-3.4-oo**

(blank)...natural (ivory)

K...black R...red E...blue M...green Y...Yellow

ZH CONNECTOR

SMT type shrouded header

SM2 type Side entry type

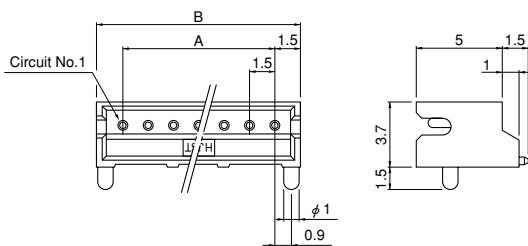

SM2 type

| Circuits | Model No. | Dimensions (mm) | | Q'ty/ reel | |
|----------|-----------------------|-----------------|------|---------------|-------|
| | | Side entry type | A | | B |
| 2 | S2B-ZR-SM2-TF | | 1.5 | 4.5 | 1,000 |
| 3 | S3B-ZR-SM2-TF | | 3.0 | 6.0 | 1,000 |
| 4 | S4B-ZR-SM2-TF | | 4.5 | 7.5 | 1,000 |
| 5 | S5B-ZR-SM2-TF | | 6.0 | 9.0 | 1,000 |
| 6 | S6B-ZR-SM2-TF | | 7.5 | 10.5 | 1,000 |
| 7 | S7B-ZR-SM2-TF | | 9.0 | 12.0 | 1,000 |
| 8 | S8B-ZR-SM2-TF | | 10.5 | 13.5 | 1,000 |
| 9 | S9B-ZR-SM2-TF | | 12.0 | 15.0 | 1,000 |
| 10 | S10B-ZR-SM2-TF | | 13.5 | 16.5 | 1,000 |
| 11 | S11B-ZR-SM2-TF | | 15.0 | 18.0 | 1,000 |
| 12 | S12B-ZR-SM2-TF | | 16.5 | 19.5 | 1,000 |
| 13 | S13B-ZR-SM2-TF | | 18.0 | 21.0 | 1,000 |

Material and Finish

Pin: Brass, copper-undercoated, tin-plated (reflow treatment)
Wafer: Glass-filled PA 46, UL94V-0, natural (ivory)

RoHS compliance This product displays (LF)(SN) on a label.

SM4 type (with solder tabs) Top entry type

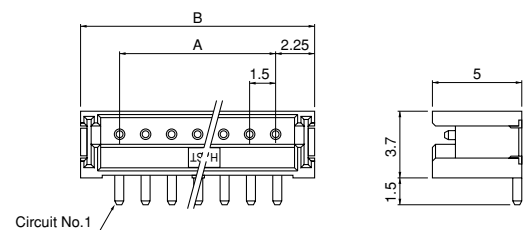

SM4 type

| Circuits | Model No. | | Dimensions (mm) | | Q'ty/reel | |
|----------|-----------------------|------------------------|-----------------|------|----------------|-----------------|
| | Top entry type | Side entry type | A | B | Top entry type | Side entry type |
| 2 | B2B-ZR-SM4-TF | S2B-ZR-SM4A-TF | 1.5 | 6.0 | 1,000 | 1,000 |
| 3 | B3B-ZR-SM4-TF | S3B-ZR-SM4A-TF | 3.0 | 7.5 | 1,000 | 1,000 |
| 4 | B4B-ZR-SM4-TF | S4B-ZR-SM4A-TF | 4.5 | 9.0 | 1,000 | 1,000 |
| 5 | B5B-ZR-SM4-TF | S5B-ZR-SM4A-TF | 6.0 | 10.5 | 1,000 | 1,000 |
| 6 | B6B-ZR-SM4-TF | S6B-ZR-SM4A-TF | 7.5 | 12.0 | 1,000 | 1,000 |
| 7 | B7B-ZR-SM4-TF | S7B-ZR-SM4A-TF | 9.0 | 13.5 | 1,000 | 1,000 |
| 8 | B8B-ZR-SM4-TF | S8B-ZR-SM4A-TF | 10.5 | 15.0 | 1,000 | 1,000 |
| 9 | B9B-ZR-SM4-TF | S9B-ZR-SM4A-TF | 12.0 | 16.5 | 1,000 | 1,000 |
| 10 | B10B-ZR-SM4-TF | S10B-ZR-SM4A-TF | 13.5 | 18.0 | 1,000 | 1,000 |
| 11 | B11B-ZR-SM4-TF | S11B-ZR-SM4A-TF | 15.0 | 19.5 | 1,000 | 1,000 |
| 12 | B12B-ZR-SM4-TF | S12B-ZR-SM4A-TF | 16.5 | 21.0 | 1,000 | 1,000 |
| 13 | B13B-ZR-SM4-TF | S13B-ZR-SM4A-TF | 18.0 | 22.5 | 1,000 | 1,000 |

Material and Finish

Pin: Brass, copper-undercoated, tin-plated (reflow treatment)
Wafer: PA 6T, UL94V-0, natural (ivory)
Solder tab: Brass, copper-undercoated, tin-plated (reflow treatment)

RoHS compliance This product displays (LF)(SN) on a label.

Note: 1. PA 9T is used for some colored products.

2. The products listed above are supplied on embossed-tape.

3. Contact JST for the top entry type headers with suction cap.

<For reference> As the color identification, the following alphabet shall be put in the underlined part.

For availability, delivery and minimum order quantity, contact JST.

ex. **S2B-ZR-SM4A-oo-TF**

(blank)...natural (ivory)

K...black R...red E...blue M...green L...lemon yellow

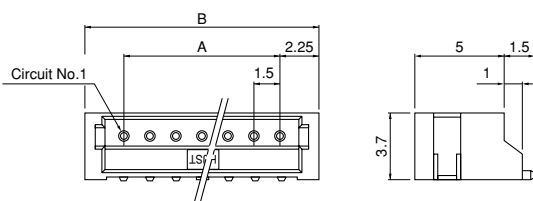

LE...light blue DO...dark orange DH...dark gray

Side entry type



Looking for pricing, stock, or lifecycle information?

Click below to explore more details on WIN SOURCE:

-  [View S7B-ZR-SM4A-TF\(LF\)\(SN\) on WIN SOURCE](#)
-  [JST Sales America Inc. Information](#)

Optimize Your Supply Chain with WIN SOURCE Solutions

-  Global Sourcing Solution
-  Obsolete Management
-  Cost Control Management
-  Shortage Management
-  Alternative Solution
-  Excess Inventory Management