



**THE DATASHEET OF
74ABT126CSCX**



74ABT126

Quad Buffer with 3-STATE Outputs

Features

- Non-inverting buffers
- Output sink capability of 64mA, source capability of 32mA
- Guaranteed latching protection
- High impedance glitch free bus loading during entire power up and power down cycle
- Nondestructive hot insertion capability
- Disable time less than enable time to avoid bus contention

General Description

The ABT126 contains four independent non-inverting buffers with 3-STATE outputs.

Ordering Information

Order Number	Package Number	Package Description
74ABT126CSC	M14A	14-Lead Small Outline Integrated Circuit (SOIC), JEDEC MS-012, 0.150" Narrow
74ABT126CSJ	M14D	14-Lead Small Outline Package (SOP), EIAJ TYPE II, 5.3mm Wide
74ABT126CMT	MTC14	14-Lead Thin Shrink Small Outline Package (TSSOP), JEDEC MO-153, 4.4mm Wide

Device also available in Tape and Reel. Specify by appending suffix letter "X" to the ordering number.

 All packages are lead free per JEDEC: J-STD-020B standard.

Connection Diagram

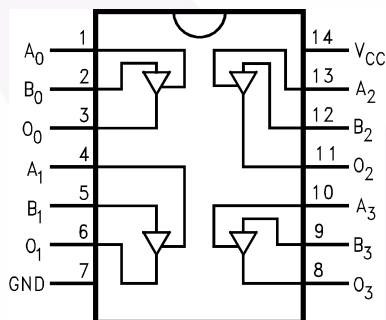

Function Table

Inputs		Output
A _n	B _n	O _n
H	L	L
H	H	H
L	X	Z

H = HIGH Voltage Level

L = LOW Voltage Level

Z = HIGH Impedance

X = Immaterial

Pin Description

Pin Names	Description
A _n , B _n	Inputs
O _n	Outputs

Absolute Maximum Ratings

Stresses exceeding the absolute maximum ratings may damage the device. The device may not function or be operable above the recommended operating conditions and stressing the parts to these levels is not recommended. In addition, extended exposure to stresses above the recommended operating conditions may affect device reliability. The absolute maximum ratings are stress ratings only.

Symbol	Parameter	Rating
T_{STG}	Storage Temperature	-65°C to +150°C
T_A	Ambient Temperature Under Bias	-55°C to +125°C
T_J	Junction Temperature Under Bias	-55°C to +150°C
V_{CC}	V_{CC} Pin Potential to Ground Pin	-0.5V to +7.0V
V_{IN}	Input Voltage ⁽¹⁾	-0.5V to +7.0V
I_{IN}	Input Current ⁽¹⁾	-30mA to +5.0mA
V_O	Voltage Applied to Any Output	
	Disabled or Power-Off State	-0.5V to 5.5V
	HIGH State	-0.5V to V_{CC}
	Current Applied to Output in LOW State (Max.)	twice the rated I_{OL} (mA)
	DC Latchup Source Current (Across Comm Operating Range)	-300mA
	Over Voltage Latchup (I/O)	10V

Note:

1. Either voltage limit or current limit is sufficient to protect inputs.

Recommended Operating Conditions

The Recommended Operating Conditions table defines the conditions for actual device operation. Recommended operating conditions are specified to ensure optimal performance to the datasheet specifications. Fairchild does not recommend exceeding them or designing to absolute maximum ratings.

Symbol	Parameter	Rating
T_A	Free Air Ambient Temperature	-40°C to +85°C
V_{CC}	Supply Voltage	+4.5V to +5.5V
$\Delta V / \Delta t$	Minimum Input Edge Rate	
	Data Input	50mV/ns
	Enable Input	100mV/ns

DC Electrical Characteristics

Symbol	Parameter		V _{CC}	Conditions	Min.	Typ.	Max.	Units
V _{IH}	Input HIGH Voltage			Recognized HIGH Signal	2.0			V
V _{IL}	Input LOW Voltage			Recognized LOW Signal			0.8	V
V _{CD}	Input Clamp Diode Voltage		Min.	I _{IN} = -18mA			-1.2	V
V _{OH}	Output HIGH Voltage		Min.	I _{OH} = -3mA	2.5			V
				I _{OH} = -32mA	2.0			
V _{OL}	Output LOW Voltage		Min.	I _{OL} = 64mA			0.55	V
I _{IH}	Input HIGH Current		Max.	V _{IN} = 2.7V ⁽²⁾			1	μA
				V _{IN} = V _{CC}			1	
I _{BVI}	Input HIGH Current Breakdown Test		Max.	V _{IN} = 7.0V			7	μA
I _{IL}	Input LOW Current		Max.	V _{IN} = 0.5V ⁽²⁾			-1	μA
				V _{IN} = 0.0V			-1	
V _{ID}	Input Leakage Test		0.0	I _{ID} = 1.9μA, All Other Pins Grounded	4.75			V
I _{OZH}	Output Leakage Current		0-5.5V	V _{OUT} = 2.7V, $\overline{OE}_n = 2.0V$			10	μA
I _{OZL}	Output Leakage Current		0-5.5V	V _{OUT} = 0.5V, $\overline{OE}_n = 2.0V$			-10	μA
I _{OS}	Output Short-Circuit Current		Max.	V _{OUT} = 0.0V	-100		-275	mA
I _{CEx}	Output HIGH Leakage Current		Max.	V _{OUT} = V _{CC}			50	μA
I _{ZZ}	Bus Drainage Test		0.0	V _{OUT} = 5.5V, All Others GND			100	μA
I _{CCH}	Power Supply Current		Max.	All Outputs HIGH			50	μA
I _{CCL}	Power Supply Current		Max.	All Outputs LOW			15	mA
I _{CCZ}	Power Supply Current		Max.	$\overline{OE}_n = V_{CC}$, All Others at V _{CC} or Ground			50	μA
I _{CCT}	Additional I _{CC} /Input	Outputs Enabled	Max.	V _I = V _{CC} - 2.1V			1.5	mA
		Outputs 3-STATE		Enable Input V _I = V _{CC} - 2.1V			1.5	mA
		Outputs 3-STATE		Data Input V _I = V _{CC} - 2.1V, All Others at V _{CC} or Ground			50	μA
I _{CCD}	Dynamic I _{CC} No Load ⁽²⁾		Max.	Outputs OPEN, $\overline{OE}_n = GND$ ⁽³⁾ , One-Bit Toggling, 50% Duty Cycle			0.1	mA/MHz

Notes:

- Guaranteed, but not tested.
- For 8-bit toggling, I_{CCD} < 0.8mA/MHz.

AC Electrical Characteristics

Symbol	Parameter	$T_A = +25^\circ\text{C}$, $V_{CC} = +5\text{V}$, $C_L = 50\text{pF}$			$T_A = -40^\circ\text{C to } +85^\circ\text{C}$ $V_{CC} = 4.5\text{V} - 5.5\text{V}$ $C_L = 50\text{pF}$		Units
		Min.	Typ.	Max.	Min.	Max.	
t_{PLH}	Propagation Delay, Data to Outputs	1.0		4.4	1.0	4.4	ns
t_{PHL}		1.0		4.6	1.0	4.6	
t_{PZH}	Output Enable Time	1.0		6.5	1.0	6.5	ns
t_{PZL}		1.0		6.5	1.0	6.5	
t_{PHZ}	Output Disable Time	1.0		5.8	1.0	5.8	ns
t_{PLZ}		1.0		5.5	1.0	5.5	

Capacitance

Symbol	Parameter	Conditions $T_A = 25^\circ\text{C}$	Typ.	Units
C_{IN}	Input Capacitance	$V_{CC} = 0\text{V}$	5.0	pF
$C_{OUT}^{(4)}$	Output Capacitance	$V_{CC} = 5.0\text{V}$	9.0	pF

Note:

4. C_{OUT} is measured at frequency $f = 1\text{MHz}$, per MIL-STD-883, Method 3012.

Physical Dimensions

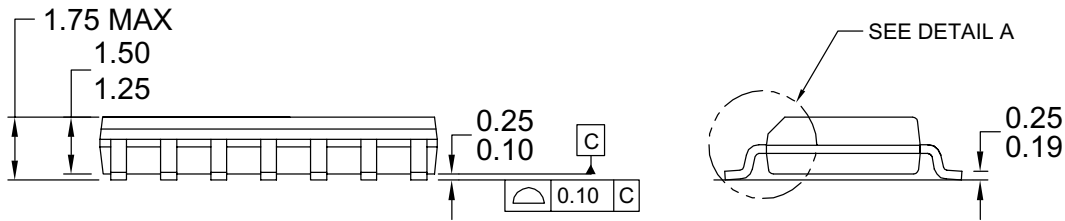
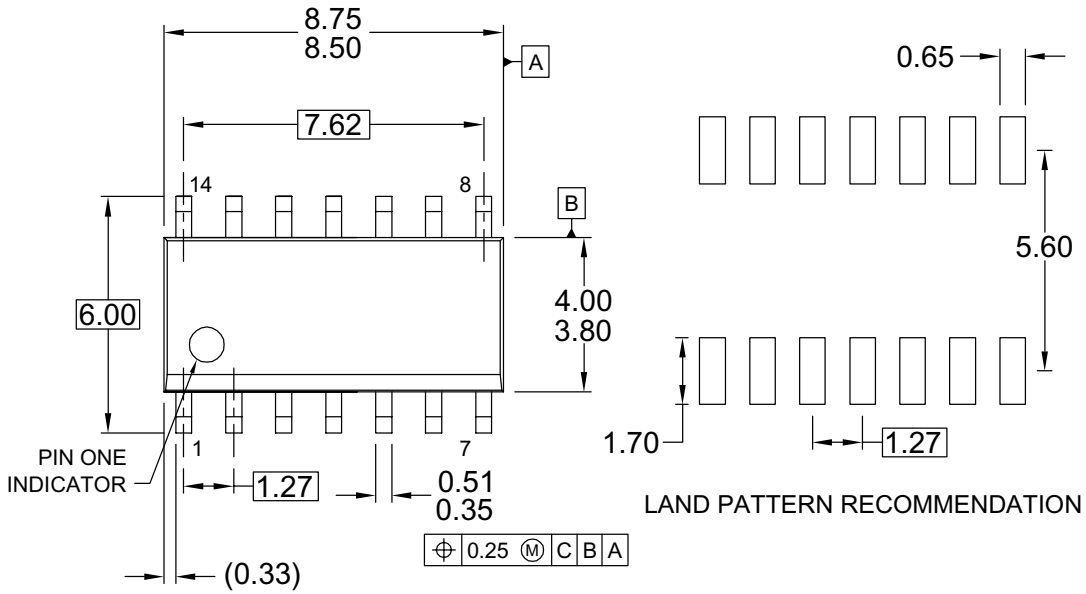

NOTES: UNLESS OTHERWISE SPECIFIED

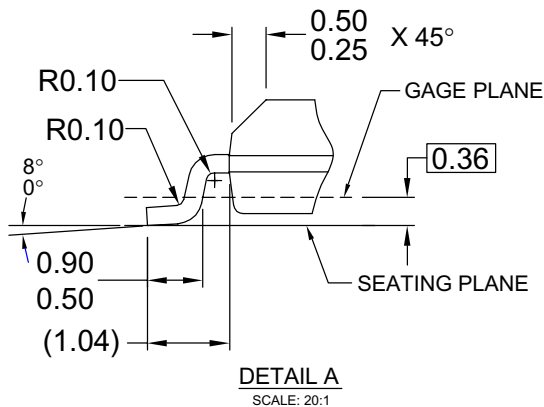

- A) THIS PACKAGE CONFORMS TO JEDEC MS-012, VARIATION AB, ISSUE C,
- B) ALL DIMENSIONS ARE IN MILLIMETERS.
- C) DIMENSIONS DO NOT INCLUDE MOLD FLASH OR BURRS.
- D) LANDPATTERN STANDARD: SOIC127P600X145-14M
- E) DRAWING CONFORMS TO ASME Y14.5M-1994
- F) DRAWING FILE NAME: M14AREV13

Figure 1. 14-Lead Small Outline Integrated Circuit (SOIC), JEDEC MS-012, 0.150" Narrow

Package drawings are provided as a service to customers considering Fairchild components. Drawings may change in any manner without notice. Please note the revision and/or date on the drawing and contact a Fairchild Semiconductor representative to verify or obtain the most recent revision. Package specifications do not expand the terms of Fairchild's worldwide terms and conditions, specifically the warranty therein, which covers Fairchild products.



Always visit Fairchild Semiconductor's online packaging area for the most recent package drawings:

<http://www.fairchildsemi.com/packaging/>



TRADEMARKS

The following includes registered and unregistered trademarks and service marks, owned by Fairchild Semiconductor and/or its global subsidiaries, and is not intended to be an exhaustive list of all such trademarks.

- | | | | |
|---|--|--|----------------------------------|
| ACEx [®] | FPST [™] | PDP-SPM [™] | SyncFET [™] |
| Build it Now [™] | FRFET [®] | Power220 [®] | SYSTEM [®] |
| CorePLUS [™] | Global Power Resource SM | Power247 [®] | GENERAL [®] |
| CROSSVOLT [™] | Green FPS [™] | POWEREDGE [®] | The Power Franchise [®] |
| CTL [™] | Green FPS [™] e-Series [™] | Power-SPM [™] | the power [™] |
| Current Transfer Logic [™] | GTO [™] | PowerTrench [®] | franchise |
| EcoSPARK [®] | i-Lo [™] | Programmable Active Droop [™] | TinyBoost [™] |
| EZSWITCH [™] * | IntelliMAX [™] | QFET [®] | TinyBuck [™] |
|  ™ | ISOPLANAR [™] | QS [™] | TinyLogic [®] |
|  ™ | MegaBuck [™] | QT Optoelectronics [™] | TINYOPTO [™] |
| Fairchild [®] | MICROCOUPLER [™] | Quiet Series [™] | TinyPower [™] |
| Fairchild Semiconductor [®] | MicroFET [™] | RapidConfigure [™] | TinyPWM [™] |
| FACT Quiet Series [™] | MicroPak [™] | SMART START [™] | TinyWire [™] |
| FACT [®] | MillerDrive [™] | SPM [®] | μSerDes [™] |
| FAST [®] | Motion-SPM [™] | STEALTH [™] | UHC [®] |
| FastvCore [™] | OPTOLOGIC [®] | SuperFET [™] | Ultra FRFET [™] |
| FlashWriter [®] * | OPTOPLANAR [®] | SuperSOT [™] -3 | UniFET [™] |
| | | SuperSOT [™] -6 | VCX [™] |
| | | SuperSOT [™] -8 | |

* EZSWITCH[™] and FlashWriter[®] are trademarks of System General Corporation, used under license by Fairchild Semiconductor.

DISCLAIMER

FAIRCHILD SEMICONDUCTOR RESERVES THE RIGHT TO MAKE CHANGES WITHOUT FURTHER NOTICE TO ANY PRODUCTS HEREIN TO IMPROVE RELIABILITY, FUNCTION, OR DESIGN. FAIRCHILD DOES NOT ASSUME ANY LIABILITY ARISING OUT OF THE APPLICATION OR USE OF ANY PRODUCT OR CIRCUIT DESCRIBED HEREIN; NEITHER DOES IT CONVEY ANY LICENSE UNDER ITS PATENT RIGHTS, NOR THE RIGHTS OF OTHERS. THESE SPECIFICATIONS DO NOT EXPAND THE TERMS OF FAIRCHILD'S WORLDWIDE TERMS AND CONDITIONS, SPECIFICALLY THE WARRANTY THEREIN, WHICH COVERS THESE PRODUCTS.

LIFE SUPPORT POLICY

FAIRCHILD'S PRODUCTS ARE NOT AUTHORIZED FOR USE AS CRITICAL COMPONENTS IN LIFE SUPPORT DEVICES OR SYSTEMS WITHOUT THE EXPRESS WRITTEN APPROVAL OF FAIRCHILD SEMICONDUCTOR CORPORATION.

As used herein:

1. Life support devices or systems are devices or systems which, (a) are intended for surgical implant into the body or (b) support or sustain life, and (c) whose failure to perform when properly used in accordance with instructions for use provided in the labeling, can be reasonably expected to result in a significant injury of the user.
2. A critical component in any component of a life support, device, or system whose failure to perform can be reasonably expected to cause the failure of the life support device or system, or to affect its safety or effectiveness.

PRODUCT STATUS DEFINITIONS

Definition of Terms

Datasheet Identification	Product Status	Definition
Advance Information	Formative or In Design	This datasheet contains the design specifications for product development. Specifications may change in any manner without notice.
Preliminary	First Production	This datasheet contains preliminary data; supplementary data will be published at a later date. Fairchild Semiconductor reserves the right to make changes at any time without notice to improve design.
No Identification Needed	Full Production	This datasheet contains final specifications. Fairchild Semiconductor reserves the right to make changes at any time without notice to improve the design.
Obsolete	Not In Production	This datasheet contains specifications on a product that has been discontinued by Fairchild Semiconductor. The datasheet is printed for reference information only.

Rev. I32

Looking for pricing, stock, or lifecycle information?

Click below to explore more details on WIN SOURCE:

 [View 74ABT126CSCX on WIN SOURCE](#)

 [Fairchild/ON Semiconductor](#) Information

Optimize Your Supply Chain with WIN SOURCE Solutions

-  Global Sourcing Solution
-  Obsolete Management
-  Cost Control Management
-  Shortage Management
-  Alternative Solution
-  Excess Inventory Management