



**THE DATASHEET OF  
SBR0220T5-7**



## Features

- Low Forward Voltage Drop
- Superior Reverse Avalanche Capability
- Patented Super Barrier Rectifier Technology
- Soft, Fast Switching Capability
- 150°C Operating Junction Temperature
- **Lead Free Finish, RoHS Compliant**
- **“Green” Molding Compound (No Br, Sb)**

## Mechanical Data

- Case: SOD-523
- Case Material: Molded Plastic, “Green” Molding Compound. UL Flammability Classification Rating 94V-0
- Moisture Sensitivity: Level 1 per J-STD-020D
- Polarity Indicator: Cathode Band
- Terminals: Finish – Matte Tin annealed over Alloy 42 leadframe. Solderable per MIL-STD-202, Method 208 **e3**
- Marking Information: See Page 2
- Ordering Information: See Page 2
- Weight: 0.002 grams (approximate)



Top View

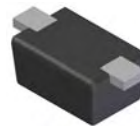

Bottom View

## Maximum Ratings @T<sub>A</sub> = 25°C unless otherwise specified

Single phase, half wave, 60Hz, resistive or inductive load.  
For capacitance load, derate current by 20%.

Characteristic	Symbol	Value	Unit
Peak Repetitive Reverse Voltage	V <sub>RRM</sub>	20	V
Working Peak Reverse Voltage	V <sub>RWM</sub>		
DC Blocking Voltage	V <sub>RM</sub>		
RMS Reverse Voltage	V <sub>R(RMS)</sub>	14	V
Average Rectified Output Current (See Figure 1)	I <sub>O</sub>	0.2	A
Non-Repetitive Peak Forward Surge Current 8.3ms Single Half Sine-Wave Superimposed on Rated Load	I <sub>FSM</sub>	5	A

## Thermal Characteristics

Characteristic	Symbol	Value	Unit
Maximum Thermal Resistance	R <sub>θJA</sub>	400	°C/W
Thermal Resistance Junction to Soldering (Note 1)			
Operating and Storage Temperature Range	T <sub>J</sub> , T <sub>STG</sub>	-65 to +150	°C

## Electrical Characteristics @T<sub>A</sub> = 25°C unless otherwise specified

Characteristic	Symbol	Min	Typ	Max	Unit	Test Condition
Reverse Breakdown Voltage (Note 2)	V <sub>(BR)R</sub>	20	-	-	V	I <sub>R</sub> = 400μA
Forward Voltage Drop	V <sub>F</sub>	-	0.37	0.41	V	I <sub>F</sub> = 0.1A, T <sub>J</sub> = 25°C
			0.34	0.38		I <sub>F</sub> = 0.1A, T <sub>J</sub> = 85°C
			0.43	0.47		I <sub>F</sub> = 0.2A, T <sub>J</sub> = 25°C
			0.41	0.45		I <sub>F</sub> = 0.2A, T <sub>J</sub> = 85°C
Leakage Current (Note 2)	I <sub>R</sub>	-	-	40	μA mA	V <sub>R</sub> = 20V, T <sub>J</sub> = 25°C
			-	0.5		V <sub>R</sub> = 20V, T <sub>J</sub> = 85°C

Notes: 1. FR-4 PCB, 2 oz. Copper, minimum recommended pad layout per <http://www.diodes.com/datasheets/ap02001.pdf>.  
2. Short duration pulse test used to minimize self-heating effect.

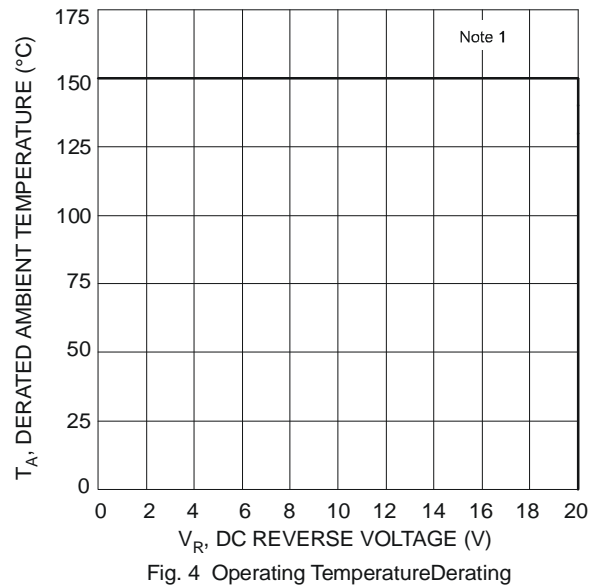
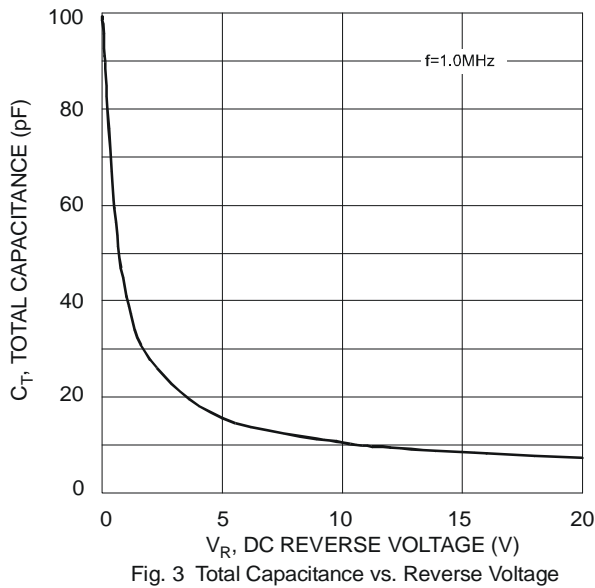
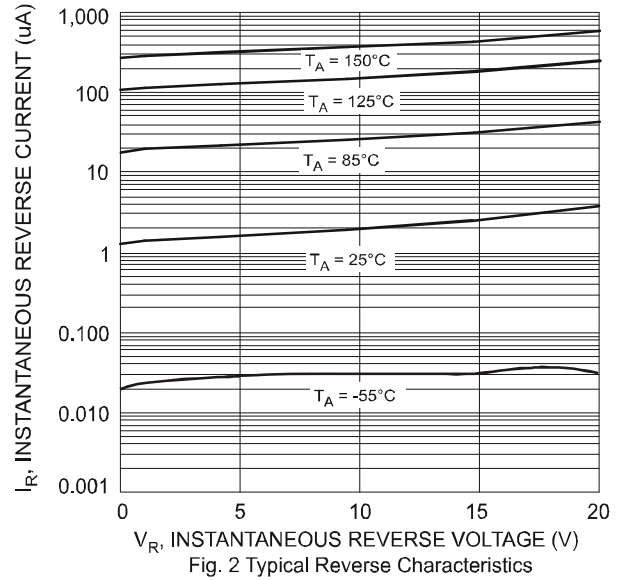
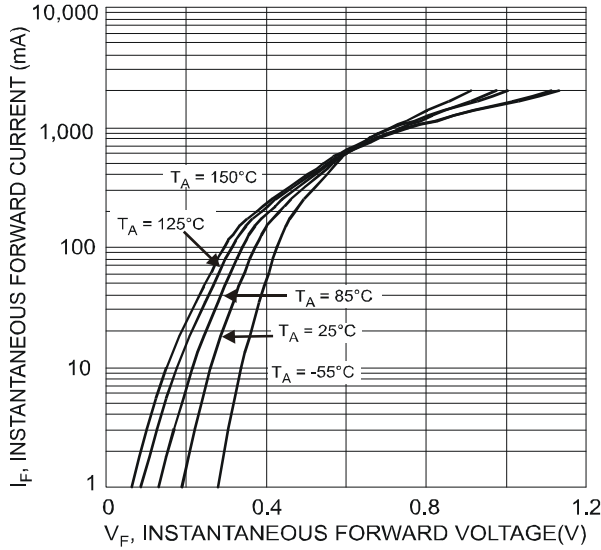

**Ordering Information** (Note 3)

Part Number	Case	Packaging
SBR0220T5-7 (Note 4)	SOD-523	3000/Tape & Reel

Notes: 3. For packaging details, go to our website at <http://www.diodes.com/datasheets/ap02007.pdf>.  
4. Dispensed in every other cavity of the tape.

**Marking Information**

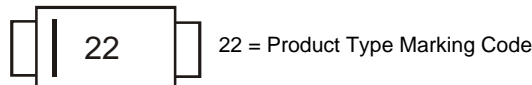

## Package Outline Dimensions

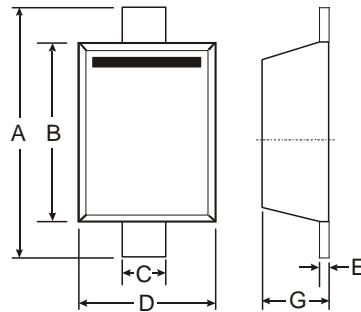

SOD-523		
Dim	Min	Max
A	1.50	1.70
B	1.10	1.30
C	0.25	0.35
D	0.70	0.90
E	0.10	0.20
G	0.50	0.70
All Dimensions in mm		

## Suggested Pad Layout

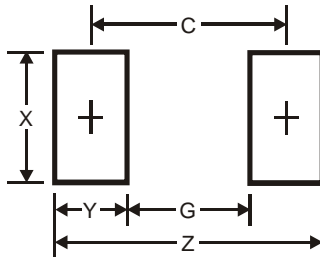

Dimensions	Value (in mm)
Z	2.3
G	1.1
X	0.8
Y	0.6
C	1.7

### IMPORTANT NOTICE

Diodes Incorporated and its subsidiaries reserve the right to make modifications, enhancements, improvements, corrections or other changes without further notice to any product herein. Diodes Incorporated does not assume any liability arising out of the application or use of any product described herein; neither does it convey any license under its patent rights, nor the rights of others. The user of products in such applications shall assume all risks of such use and will agree to hold Diodes Incorporated and all the companies whose products are represented on our website, harmless against all damages.

### LIFE SUPPORT

Diodes Incorporated products are not authorized for use as critical components in life support devices or systems without the expressed written approval of the President of Diodes Incorporated.

## Looking for pricing, stock, or lifecycle information?

Click below to explore more details on WIN SOURCE:

 [View SBR0220T5-7 on WIN SOURCE](#)

 [Diodes Incorporated](#) Information

## Optimize Your Supply Chain with WIN SOURCE Solutions

-  Global Sourcing Solution
-  Obsolete Management
-  Cost Control Management
-  Shortage Management
-  Alternative Solution
-  Excess Inventory Management