



**THE DATASHEET OF  
SC191AWLTRT**



### POWER MANAGEMENT

#### Description

The SC191 is a synchronous step-down converter with integrated power devices and an integrated front-end LDO regulator to minimize input supply ripple. If supply ripple is not a concern, the front-end LDO regulator can be bypassed externally to maximize efficiency.

The internal MOSFET switches provide peak current greater than 550mA to achieve a DC output of at least 330mA over the rated input voltage range, making the SC191 ideal for single-cell Li-ion battery applications as well as fixed 3.3V and 5V fixed input applications. The output is a fixed 1.2V - ideal for low-voltage microprocessors. Other voltage options are available (consult the factory for details).

Additional features include internal soft-start to limit in-rush current, over-current protection, over-temperature protection, and over-voltage protection.

The 1MHz switching frequency allows the use of small surface mount capacitors and inductors, and no other external compensation components are needed. The device is available in a low profile (0.8mm max height) 2.3mm x 2.3mm MLPD 8-lead package, minimizing area without compromising performance.

#### Features

- ◆ Less than 1mV Supply Ripple
- ◆ 2.7V to 5.5V Input Range
- ◆ 330mA Guaranteed Output Current
- ◆ Fixed Frequency 1MHz Operation
- ◆ No Schottky Diode Required
- ◆ Over-Current Protection
- ◆ Over-Voltage Protection
- ◆ Over-Temperature Protection
- ◆ Soft-Start
- ◆ No External Compensation Required
- ◆ MLPD-8, 2.3mm x 2.3mm Package
- ◆ WEEE and RoHS Compliant

#### Applications

- ◆ Cell Phones
- ◆ Cordless Phones
- ◆ Notebook and Subnotebook Computers
- ◆ PDAs and Mobile Communicators
- ◆ WLAN Peripherals
- ◆ Wireless Modules
- ◆ 1 Li-Ion or 3 NiMH/NiCd Powered Devices

#### Patent Pending

#### Typical Application Circuit

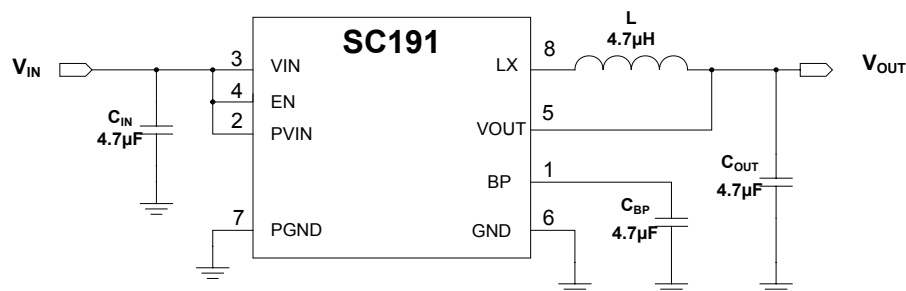

**POWER MANAGEMENT**
**Absolute Maximum Ratings**

Exceeding the specifications below may result in permanent damage to the device or device malfunction. Operation outside of the parameters specified in the Electrical Characteristics section is not recommended.

Parameter	Symbol	Maximum	Units
Input Voltage	$V_{VIN}, V_{PVIN}$	-0.3 to 7.0	V
Enable Input	$V_{EN}$	-0.3 to 7.0	V
LX Voltage	$V_{LX}$	-1 to $V_{BP} + 1$ (7V max)	V
Output Voltage	$V_{VOUT}$	-0.3 to 7.0	V
BP Voltage	$V_{BP}$	0.3 to 7.0	V
Thermal Impedance Junction to Ambient <sup>1</sup>	$\theta_{JA}$	135	°C/W
$V_{OUT}$ Short Circuit to GND	$t_{SC}$	Continuous	s
Storage Temperature	$T_S$	-60 to +160	°C
Junction Temperature	$T_{JC}$	+150	°C
Peak IR Reflow Temperature	$T_{LEAD}$	260	°C
ESD Protection Level <sup>2</sup>	$V_{ESD}$	2	kV

Notes:

- 1) Calculated from package in still air, mounted to 3" x 4.5", 4 layer FR4 PCB with thermal via under the exposed pad as per JESD51 standards.
- 2) Tested according to JEDEC standard JESD22-A114-B.

**Electrical Characteristics**

Unless otherwise noted:  $V_{IN} = 3.6V$ ,  $V_{EN} = V_{IN}$ ,  $T_A = -40^\circ C$  to  $85^\circ C$ . Typical values are at  $T_A = 25^\circ C$ .

Parameter	Symbol	Conditions	Min	Typ	Max	Units
Input Voltage Range	$V_{IN}$		2.7		5.5	V
Input Voltage Ripple	$V_{IN(P-P)}$	$C_{IN} = C_{BP} = 10\mu F$		1		mV
Line Regulation	$V_{LINEREG}$	$I_{OUT} = 150mA$	-0.3		0.3	%/V
Load Regulation	$V_{LOADREG}$	$0mA < I_{OUT} < 330mA$		0.002		%/mA
P-Channel On Resistance	$R_{DSP}$	$I_{LX} = 100mA$		0.3		$\Omega$
N-Channel On Resistance	$R_{DSN}$	$I_{LX} = 100mA$		0.2		$\Omega$
Start-Up Time	$T_{START}$	$I_{OUT} = 150mA$		1.25		ms
Output Voltage Accuracy	$\Delta V_{OUT}$	$I_{OUT} = 150mA$	-3		3	%
		$I_{OUT} = 150mA, T_A = 25^\circ C$	-1.5		1.5	%
Front End LDO (FELDO)	$V_{BP}$	$I_{BP} = 110mA^{(1)}$		300	325	mV

**POWER MANAGEMENT**
**Electrical Characteristics (Cont.)**

Parameter	Symbol	Conditions	Min	Typ	Max	Units
P-Channel Current Limit	$I_{LIM(P)}$		550	730	940	mA
N-Channel Current Limit	$I_{LIM(N)}$		-270	-420	-700	mA
Quiescent Current	$I_Q$	Switching mode, $I_{OUT} = 100\mu A$		2.5		mA
Shutdown Current	$I_{SD}$	EN tied to GND		0.1	1	$\mu A$
LX Leakage Current PMOS	$I_{LXP}$	$V_{IN} = 5.5V$ LX, EN tied to GND		0.1	1	$\mu A$
LX Leakage Current NMOS	$I_{LXN}$	$V_{IN} = V_{LX} = 5.5V$ EN tied to GND	-20	0.1		$\mu A$
Oscillator Frequency	$f_{OSC}$		0.87	1.0	1.12	MHz
UVLO Threshold (Lower)	$V_{UVLO}$		2.4	2.5	2.6	V
UVLO Hysteresis	$V_{UVLO-HYS}$			50		mV
Thermal Shutdown	$T_{SD}$			145		$^{\circ}C$
Thermal Shutdown Hysteresis	$T_{SD-HYS}$			10		$^{\circ}C$
Logic Input High	$V_{IH}$	EN pin	1.6			V
Logic Input Low	$V_{IL}$	EN pin			0.6	V
Logic Input Current High	$I_{IH}$	EN pin	-2	0.1	2	$\mu A$
Logic Input Current Low	$I_{IL}$	EN pin	-2	0.1	2	$\mu A$

Note:

 1) FELDO tested at  $I_{BP} = 110mA$ . Equivalent to  $I_{OUT} = 330mA$  at  $V_{OUT} = 1.2V$ .

## POWER MANAGEMENT

### Pin Configuration

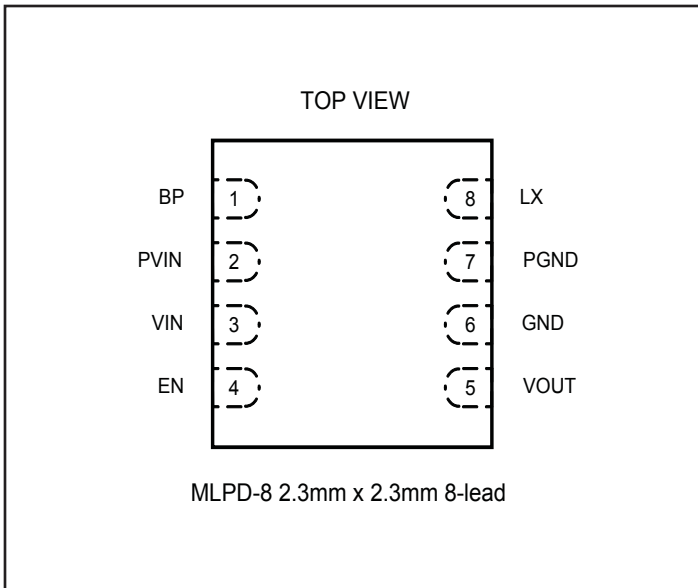

### Ordering Information

DEVICE	PACKAGE
SC191AWLTRT <sup>(1)(2)</sup>	MLPD-8LD (2.3mm x 2.3mm BODY SIZE)
SC191AEVB	Evaluation Board

Notes:

- 1) Available in tape and reel only. A reel contains 3,000 devices.
- 2) Device is WEEE and RoHS compliant.

### Output Voltage Options

PART	V <sub>OUT</sub>
SC191A	1.2V*

\*Only option currently available - contact Semtech for other voltage options.

### Marking Information

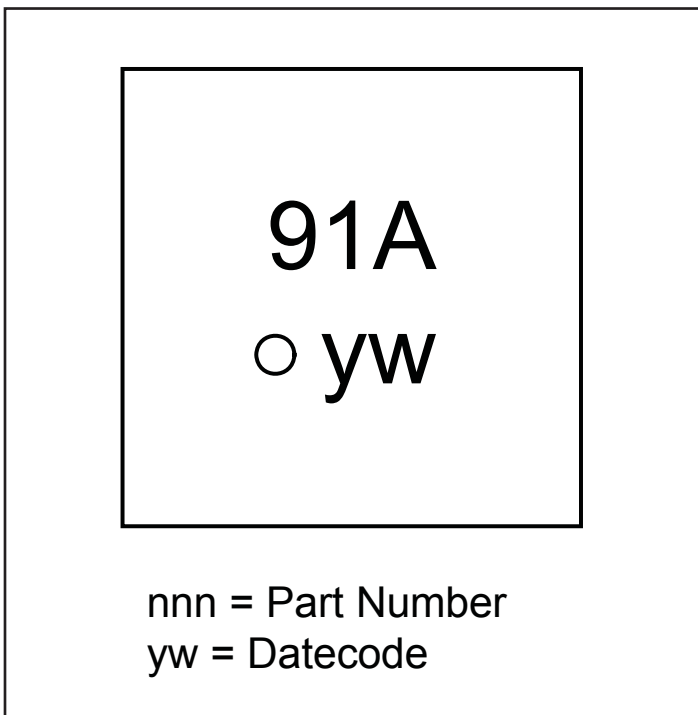

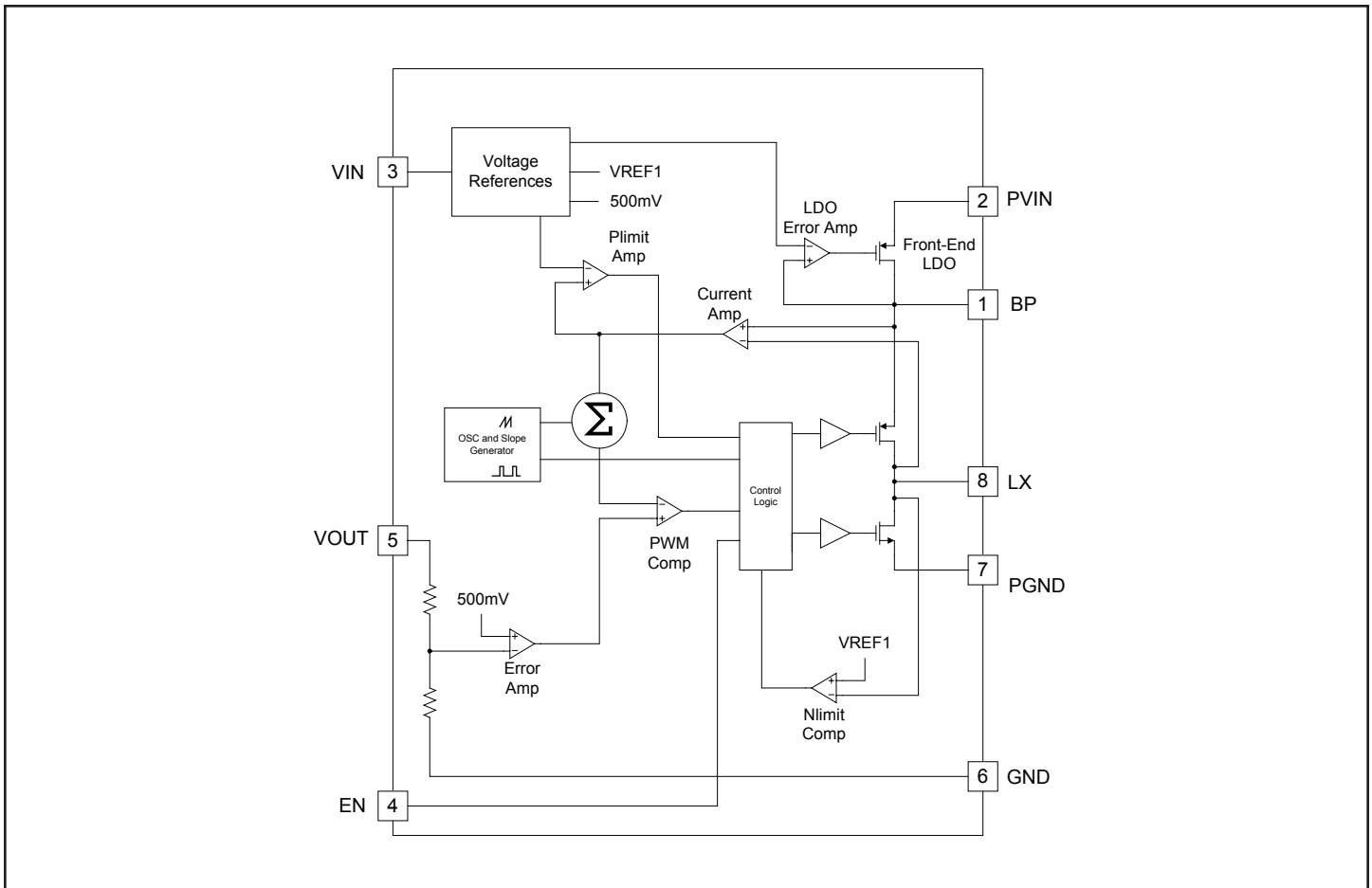
**POWER MANAGEMENT**
**Block Diagram**

**Pin Descriptions**

Pin#	Pin Name	Pin Function
1	BP	Regulated output, with respect to VIN, of the front-end LDO. A 4.7 $\mu$ F decoupling capacitor should be connected to this pin. This output is connected directly to the internal switching MOSFETs.
2	PVIN	Input power supply for the power devices.
3	VIN	Input power supply for the analog functions.
4	EN	Enable (digital input): high input enables the SC191, a low disables and reduces the quiescent current to < 1 $\mu$ A. In shutdown LX becomes high impedance.
5	VOUT	Regulated output voltage and feedback for the SC191.
6	GND	Ground: this pin should be connected directly to PGND on the user's PCB.
7	PGND	Power Ground: this pin should be connected directly to GND on the user's PCB and should be the reference point for the input, output and BP capacitor GND connections. These ground paths should be separate and as short as possible to minimize circuit noise.
8	LX	Inductor connection to the switching MOSFETs.

**POWER MANAGEMENT**
**Applications Information**
**SC191 Detailed Description**

The SC191 is a step-down, pulse-width-modulated (PWM) DC-DC converter with a Low Dropout (LDO) pre-regulator. The device has an internal synchronous rectifier and does not require a Schottky diode on the LX pin. The device is designed to operate as a buck converter in PWM mode with a fixed-frequency of 1MHz. The SC191 operates as a fixed frequency current mode regulator with the input supply for the switching regulator pre-regulated by a front-end LDO regulator. This technique reduces the supply voltage ripple from 10mV, typically seen from a switching converter, to less than 1mV for the SC191. The supply to the switcher is regulated to the supply voltage minus approximately 300mV. Current feedback for the switching regulator is through the PMOS current path, and it is amplified and summed with the internal slope compensation network and level shifted. The voltage feedback loop is through an internal feedback divider.

The on-time is determined by comparing the summed current feedback and the output of the error amplifier. The period is set by the onboard oscillator.

Efficiency at moderate to high loads can be improved by shorting the VIN and BP pins together. This bypasses the front-end LDO, reducing voltage drop and improving efficiency at the expense of increasing input supply ripple.

**Protection Features**

The SC191 provides the following protection features:

- Thermal Shutdown
- Current Limit
- Over-Voltage Protection
- Soft-Start

*Thermal Shutdown*

The thermal shutdown feature protects the device from exceeding a junction temperature of 150°C. In thermal shutdown the PWM drive is disabled, the LX output is tri-stated, and the front-end LDO is disabled. The device will not be enabled again until the temperature reduces by 10°C. If during this time the output falls by greater than 60% of its regulation voltage, a soft-start will be invoked.

*Current Limit*

The part has a number of current limit functions. The front-end LDO regulator has a current limit set at approximately 500mA, which will protect it in the event of a pulsed short circuit. The PMOS and NMOS power devices of the buck switcher stage are also protected by current limit functions. In the case of a short to ground on the output, the part enters frequency foldback mode which causes the switching frequency to divide by a factor determined by the output voltage, which prevents the inductor current from “stair stepping”.

*Over-Voltage Protection*

Over-voltage protection is provided on the SC191. In the event of an over-voltage on the output, the PWM drive is disabled, tri-stating the LX output and disabling the front-end LDO.

*Soft-Start*

The soft-start mode is enabled after every shutdown cycle to limit in-rush current. In conjunction with the frequency foldback this controls the maximum current during start-up. The switcher’s PMOS current limit is stepped from 25%, to 50%, to 75%, and then 100% of its typical value by a timer driven by the internal oscillator. The oscillator frequency is stepped by 1/8, 1/4, 1/2 and 1 under the control of 4 output voltage thresholds. As soon as the part reaches regulation, soft start mode is disabled.

**Output Filter**

The SC191 series of synchronous step-down converters have internal loop compensation. The internal compensation is designed to work with a certain output filter corner frequency defined by the equation:

$$f_c = \frac{1}{2\pi\sqrt{L \times C}}$$

The internal compensation is optimized to operate with an output filter, L = 4.7µH and C<sub>OUT</sub> = 10µF. When selecting output filter components the LC product should not vary over a wide range.

**POWER MANAGEMENT**
**Applications Information (Cont.)**
**Table 1: Output Filter Combinations**

L (μH)	C <sub>OUT</sub> (μF)
4.7	4.7
4.7	10
10	10

The selection of smaller inductor and capacitor values will move the corner frequency, having an impact on system stability. Due to this issue the practical lower limit for the inductor value is 4.7μH.

**Inductor Selection**

The value of the inductor should be in the range 4.7μH to 10μH. The magnitude of the inductor current ripple is dependant on the inductor value and can be determined by the following equation:

$$\Delta I_L = \frac{V_{OUT}}{L \times f_{OSC}} \left( 1 + \frac{V_{OUT}}{V_{IN}} \right)$$

This equation demonstrates the relationship between  $V_{IN}$ ,  $V_{OUT}$  and  $I_L$ . To minimize conduction losses and maximize efficiency, the inductor should have a low DC resistance. As a minimum requirement, the DC current rating of the inductor should be equal to the maximum load current plus half of the inductor current ripple as described by the following equation:

$$I_{L(PK)} = I_{OUT(MAX)} + \frac{\Delta I_L}{2}$$

Alternatively, the inductor saturation current should be greater than the switch current limit. Final inductor selection will depend on various design considerations such as efficiency, EMI, size and cost (see Table 2 for a list of practical inductor options).

**CIN Selection**

To prevent large input voltage ripple caused by discontinuous source input current, a low ESR ceramic capacitor is required. A minimum value of 4.7μF should be used for sufficient input voltage filtering, and a 10μF capacitor is strongly recommended for optimum input voltage filtering. Input voltage ripple of approximately 1mV can be achieved when  $C_{IN} = 10\mu F$  and the front-end LDO regulator is active and pre-regulating the input supply to the switching regulator.

**COUT Selection**

A 10μF ceramic capacitor is recommended for the output filter capacitor. Output voltage ripple is mainly determined by the filter capacitor in the following equation:

$$\Delta V_{OUT(ESR)} = \Delta I_{L(ripple)} \times ESR_{COUT}$$

X7R or X5R ceramic dielectric capacitors should be used because of their low ESR and superior temperature and voltage characteristics. Y5V ceramic capacitors should be avoided due to their widely-varying temperature coefficients.

**Table 2: Recommended Inductors**

Manufacturer	Part Number	Value (μH)	DCR Ω	Rated Current (A) (40°C rise)	I <sub>SAT</sub> (A) L drop 25%	Tolerance (± %)	Dimensions (LxWxH mm)
TDK	LDR655312T-4R7W	4.7	0.206	0.9	-	20	6.5x5.3x1.2
Sumida	CDRH3D16LD	4.7	0.073	0.68	-	30	4x4x1.8
Taiyo Yuden	LMNP04SB100M	10	0.066	0.9	-	20	5x5x2
Coilcraft	LPS3015	10	0.044	-	0.65	20	3x3x1.5
Coilcraft	LP06610-103M	10	0.41	-	0.8	20	6.9x3.8x1.0

**POWER MANAGEMENT**

**Applications Information (Cont.)**

**Table 3: Recommended Capacitors**

Manufacturer	Part Number	Value (μF)	Rated Voltage (VDC)	Temperature Coefficient	Package Size
Murata	GRM-188R60J475KE19D	4.7	6.3	X5R	0603
Murata	GRM-188R60G106ME47D	10	4	X5R	0603
TDK	C1608X5R0G106M	10	4	X5R	0603

**PCB Layout Considerations**

Poor layout can degrade the performance of the DC-DC converter and can be a contributory factor in EMI problems, ground bounce and resistive voltage losses. Poor regulation and instability can result. A few simple design rules can be implemented to ensure good layout:

- 1) Place the inductor and filter capacitors as close to the device as possible and use short, wide traces between the power components.
- 2) Route the output voltage feedback path away from in-

ductor and LX node to minimize noise and magnetic interference. Use a ground plane to further reduce noise.

- 3) Maximize ground metal on the component side to improve the return connection and thermal dissipation. Separation between the LX node and GND should be maintained to avoid coupling of switching noise to the ground plane.

- 4) To further reduce noise interference on sensitive circuit nodes, use a ground plane with several vias connecting all ground planes together.

**Suggested Layout**

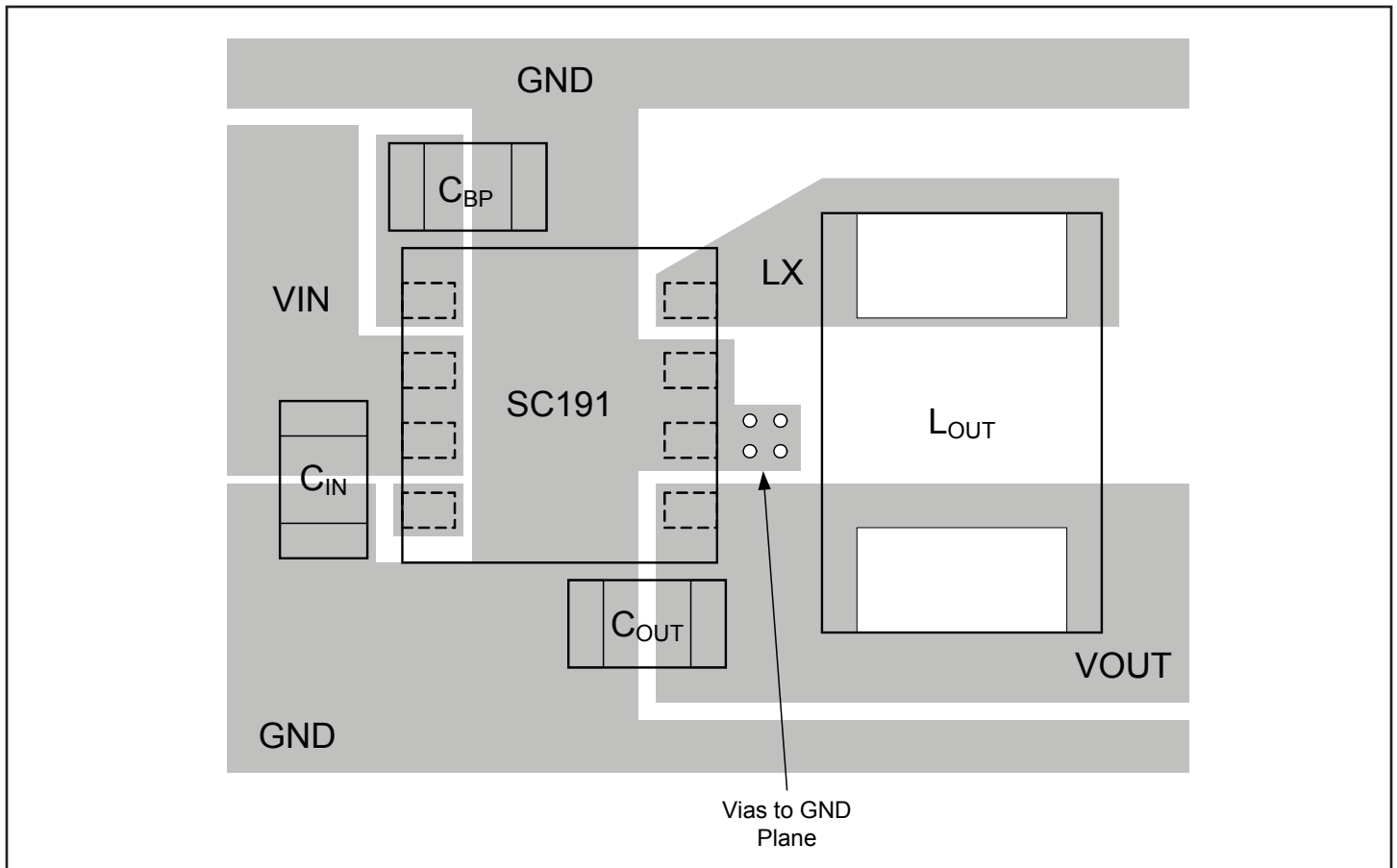

POWER MANAGEMENT

Typical Characteristics

Efficiency vs. Load Current (FELDO Active)

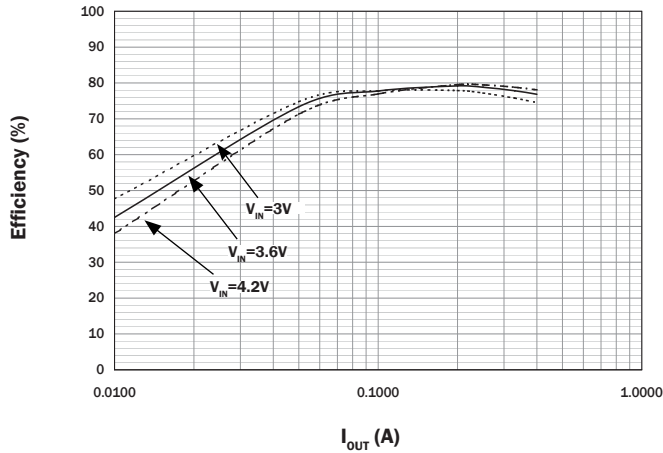

Efficiency vs. Load Current (FELDO Bypassed)

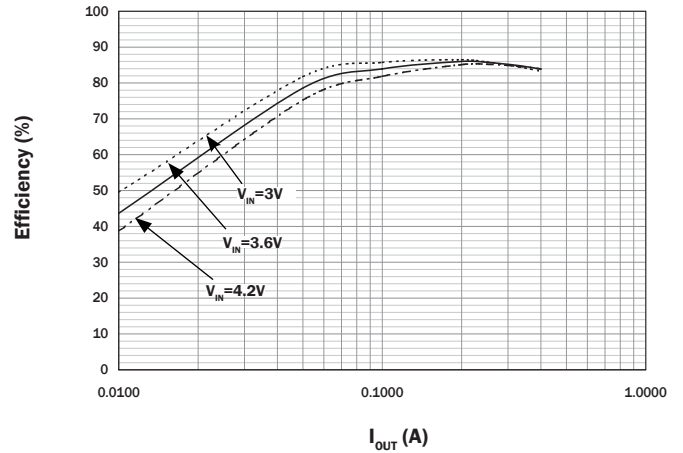

Line Regulation (FELDO Active)

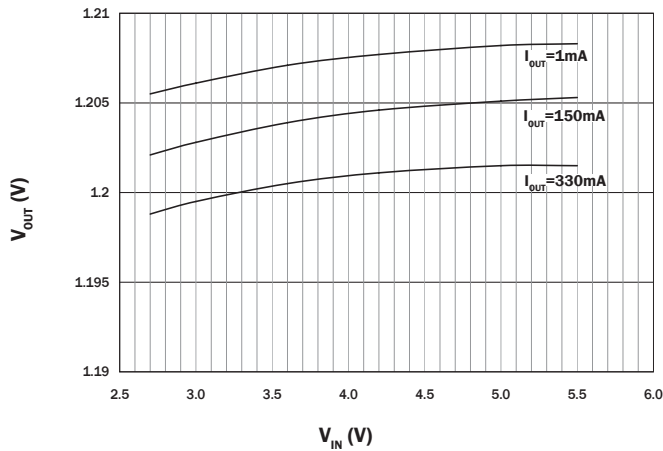

Line Regulation (FELDO Bypassed)

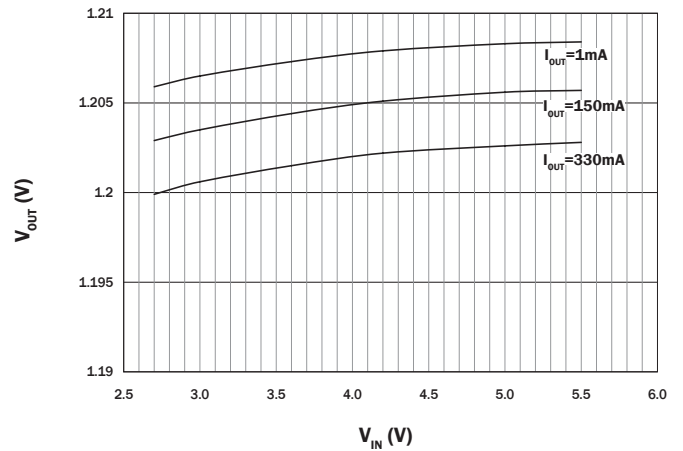

Load Regulation

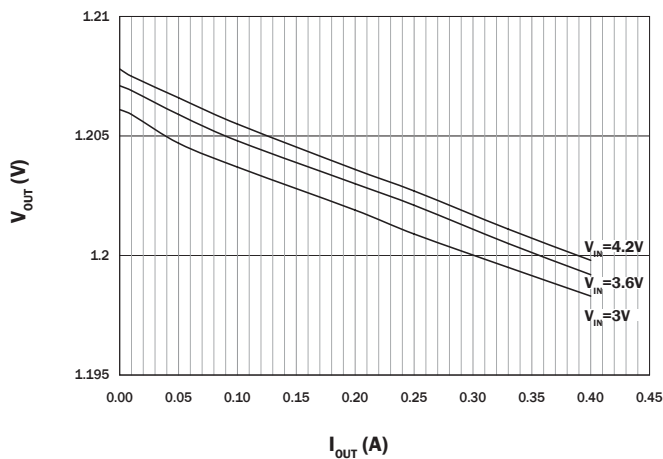

Switching Frequency vs. Temperature

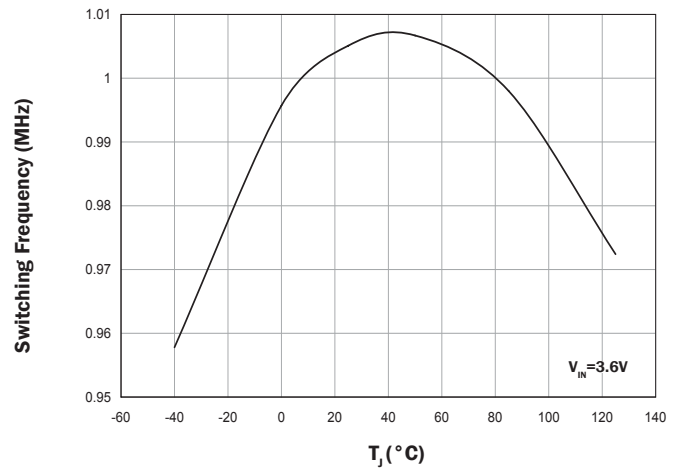

POWER MANAGEMENT

Typical Characteristics (Cont.)

Switching Frequency vs. Input Voltage

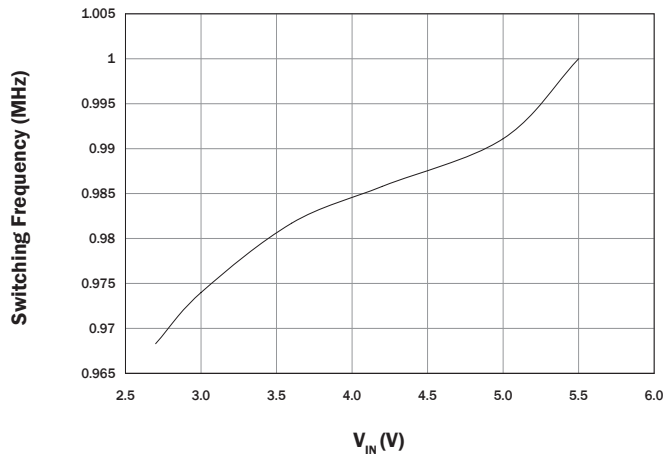

Quiescent Current vs. Input Voltage

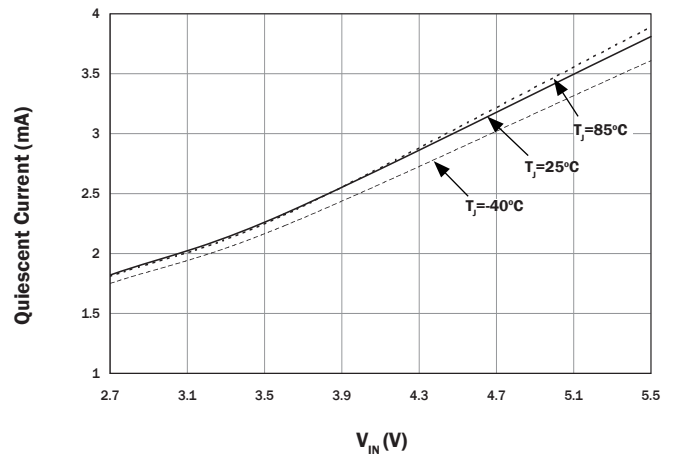

N-Channel R<sub>DSON</sub> vs. Temperature

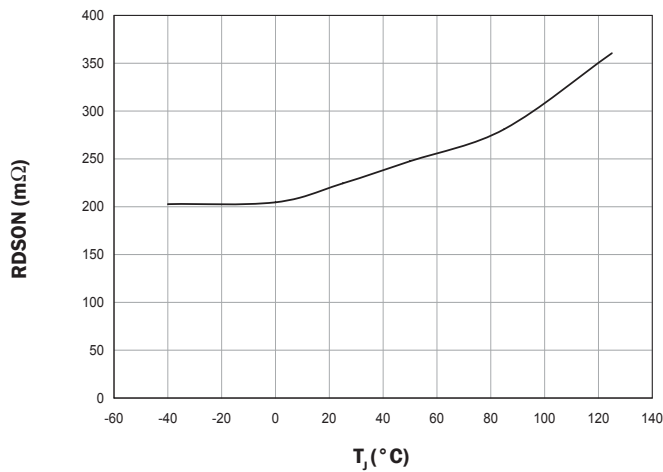

P-Channel R<sub>DSON</sub> vs. Temperature

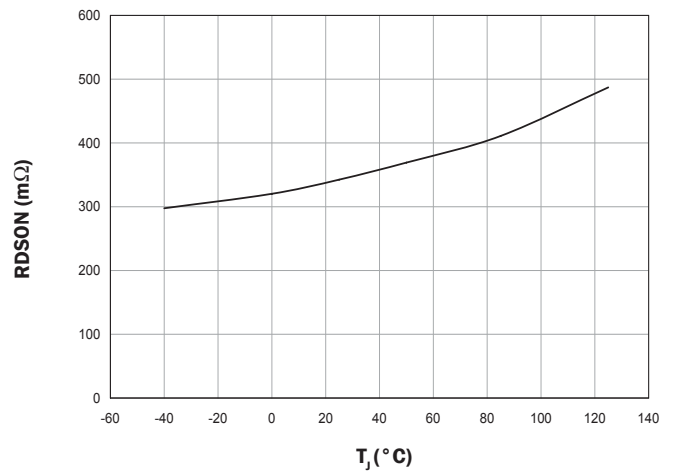

Load Transient Response

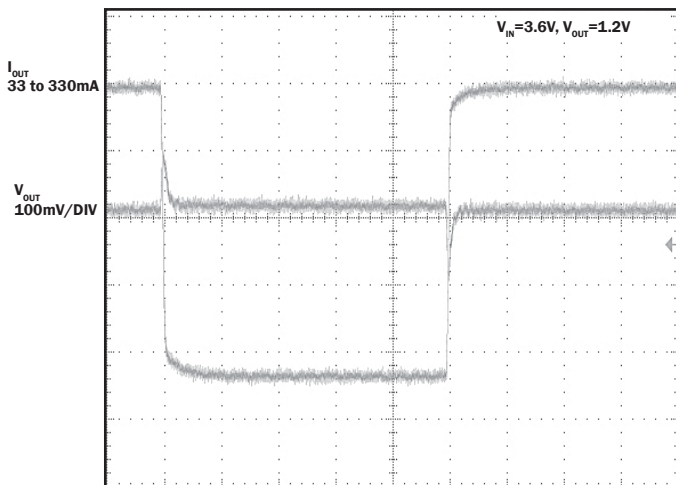

200μs/Div

Start-Up

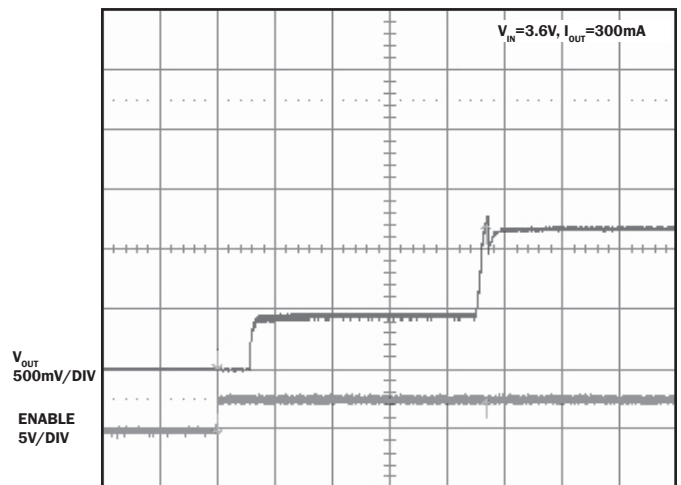

200μs/Div

POWER MANAGEMENT

Typical Characteristics (Cont.)

Input Voltage Ripple (FELDO Active)

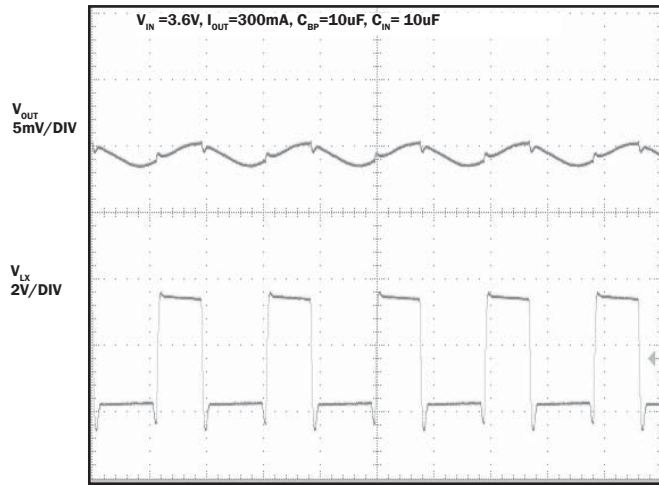

400ns/Div

Input Voltage Ripple (FELDO Bypassed)

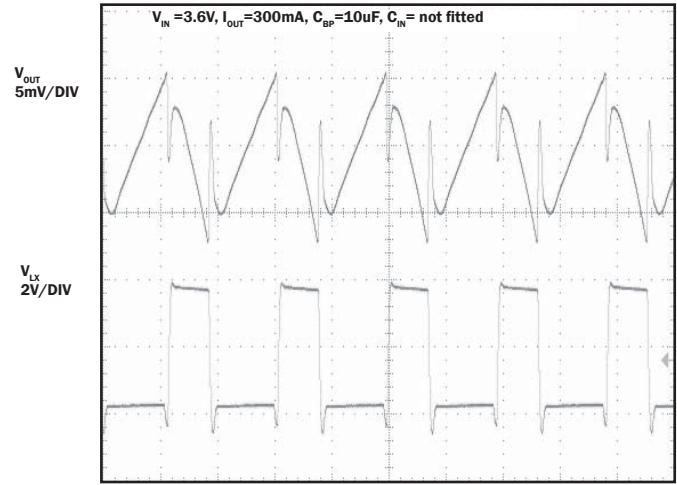

400ns/Div

Input Voltage Ripple (FELDO Bypassed)

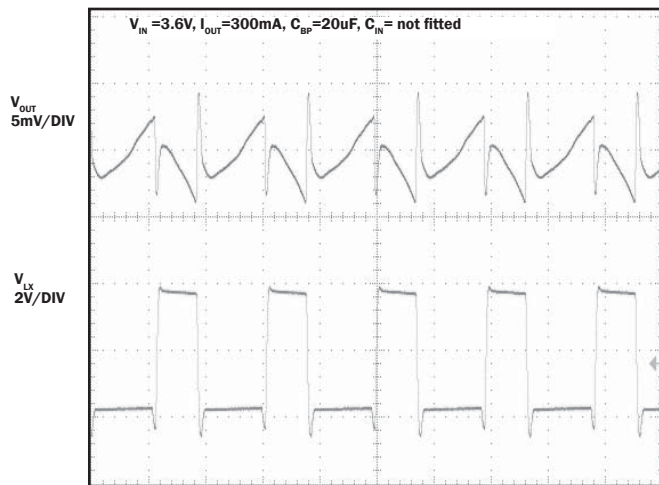

400ns/Div

POWER MANAGEMENT

Outline Drawing - MLPD-8

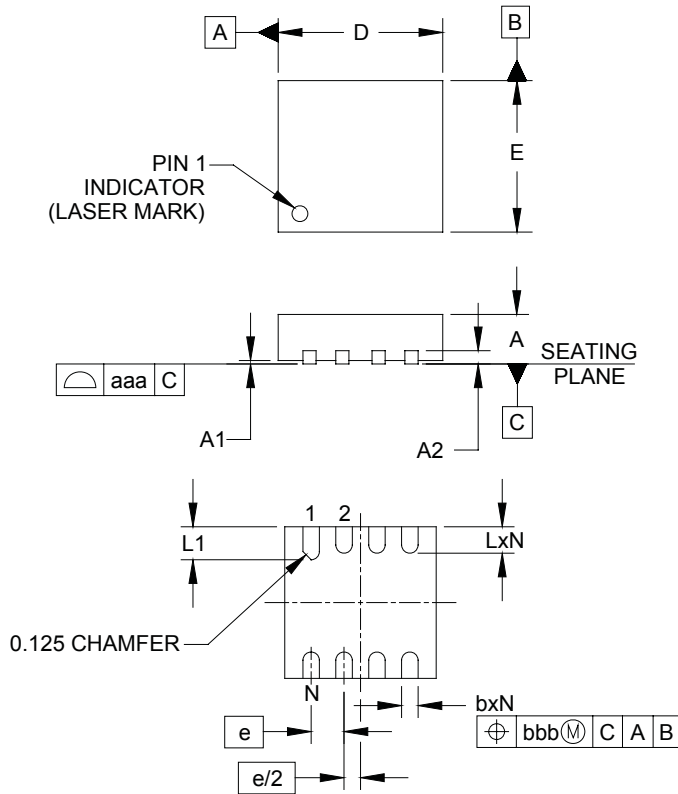

DIM	INCHES			MILLIMETERS		
	MIN	NOM	MAX	MIN	NOM	MAX
A	.028	.030	.031	0.70	0.75	0.80
A1	.000	.001	.002	0.00	0.02	0.05
A2	(.008)			(0.20)		
b	.008	.010	.012	0.20	0.25	0.30
D	.087	.091	.094	2.20	2.30	2.40
E	.087	.091	.094	2.20	2.30	2.40
e	.020 BSC		0.50 BSC			
L	.012	.016	.020	0.30	0.40	0.50
L1	.016	.020	.024	0.40	0.50	0.60
N	8			8		
aaa	.003			0.08		
bbb	.003			0.08		

NOTES:

1. CONTROLLING DIMENSIONS ARE IN MILLIMETERS (ANGLES IN DEGREES).

**POWER MANAGEMENT**

**Land Pattern - MLPD-8**

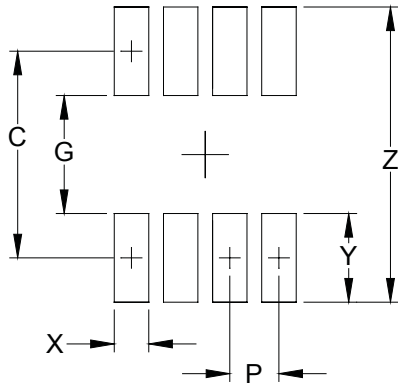

DIMENSIONS		
DIM	INCHES	MILLIMETERS
C	(.083)	(2.10)
G	.047	1.20
P	.020	0.50
X	.012	0.30
Y	.035	0.90
Z	.118	3.00

NOTES:

1. THIS LAND PATTERN IS FOR REFERENCE PURPOSES ONLY. CONSULT YOUR MANUFACTURING GROUP TO ENSURE YOUR COMPANY'S MANUFACTURING GUIDELINES ARE MET.

**Contact Information**

Semtech Corporation  
 Power Management Products Division  
 200 Flynn Road, Camarillo, CA 93012  
 Phone: (805) 498-2111 Fax: (805) 498-3804

[www.semtech.com](http://www.semtech.com)

## Looking for pricing, stock, or lifecycle information?

Click below to explore more details on WIN SOURCE:

 [View SC191AWLTRT on WIN SOURCE](#)

 [Semtech Corporation](#) Information

## Optimize Your Supply Chain with WIN SOURCE Solutions

-  Global Sourcing Solution
-  Obsolete Management
-  Cost Control Management
-  Shortage Management
-  Alternative Solution
-  Excess Inventory Management