



**THE DATASHEET OF  
74ACT157SCX**



## 74AC157 • 74ACT157 Quad 2-Input Multiplexer

### General Description

The AC/ACT157 is a high-speed quad 2-input multiplexer. Four bits of data from two sources can be selected using the common Select and Enable inputs. The four outputs present the selected data in the true (noninverted) form. The AC/ACT157 can also be used as a function generator.

### Features

- $I_{CC}$  and  $I_{OZ}$  reduced by 50%
- Outputs source/sink 24 mA
- ACT157 has TTL-compatible inputs

### Ordering Code:

Order Number	Package Number	Package Description
74AC157SC	M16A	16-Lead Small Outline Integrated Circuit (SOIC), JEDEC MS-012, 0.150" Narrow Body
74AC157SJ	M16D	16-Lead Small Outline Package (SOP), EIAJ TYPE II, 5.3mm Wide
74AC157MTC	MTC16	16-Lead Thin Shrink Small Outline Package (TSSOP), JEDEC MO-153, 4.4mm Wide
74AC157PC	N16E	16-Lead Plastic Dual-In-Line Package (PDIP), JEDEC MS-001, 0.300" Wide
74ACT157SC	M16A	16-Lead Small Outline Integrated Circuit (SOIC), JEDEC MS-012, 0.150" Narrow Body
74ACT157SJ	M16D	16-Lead Small Outline Package (SOP), EIAJ TYPE II, 5.3mm Wide
74ACT157MTC	MTC16	16-Lead Thin Shrink Small Outline Package (TSSOP), JEDEC MO-153, 4.4mm Wide
74ACT157PC	N16E	16-Lead Plastic Dual-In-Line Package (PDIP), JEDEC MS-001, 0.300" Wide

Device also available in Tape and Reel. Specify by appending suffix letter "X" to the ordering code.

### Logic Symbols

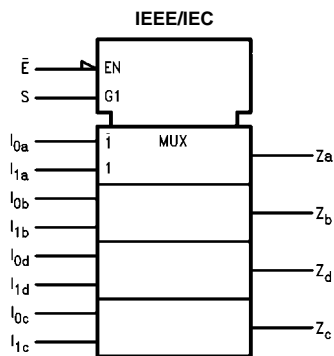
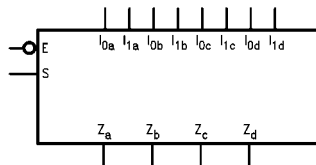

### Connection Diagram

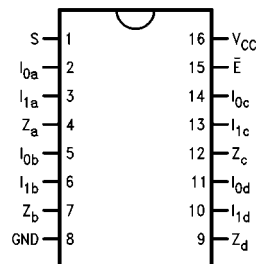

### Pin Descriptions

Pin Names	Description
$I_{0a}$ - $I_{0d}$	Source 0 Data Inputs
$I_{1a}$ - $I_{1d}$	Source 1 Data Inputs
$\bar{E}$	Enable Input
S	Select Input
$Z_a$ - $Z_d$	Outputs

FACT™ is a trademark of Fairchild Semiconductor Corporation.

### Functional Description

The AC/ACT157 is a quad 2-input multiplexer. It selects four bits of data from two sources under the control of a common Select input (S). The Enable input ( $\bar{E}$ ) is active-LOW. When  $\bar{E}$  is HIGH, all of the outputs (Z) are forced LOW regardless of all other inputs. The AC/ACT157 is the logic implementation of a 4-pole, 2-position switch where the position of the switch is determined by the logic levels supplied to the Select input. The logic equations for the outputs are shown below:

$$Z_a = \bar{E} \cdot (I_{1a} \cdot S + I_{0a} \cdot \bar{S})$$

$$Z_b = \bar{E} \cdot (I_{1b} \cdot S + I_{0b} \cdot \bar{S})$$

$$Z_c = \bar{E} \cdot (I_{1c} \cdot S + I_{0c} \cdot \bar{S})$$

$$Z_d = \bar{E} \cdot (I_{1d} \cdot S + I_{0d} \cdot \bar{S})$$

A common use of the AC/ACT157 is the moving of data from two groups of registers to four common output buses. The particular register from which the data comes is determined by the state of the Select input. A less obvious use is as a function generator. The AC/ACT157 can generate any four of the sixteen different functions of two variables with one variable common. This is useful for implementing gating functions.

### Truth Table

Inputs				Outputs
$\bar{E}$	S	$I_0$	$I_1$	Z
H	X	X	X	L
L	H	X	L	L
L	H	X	H	H
L	L	L	X	L
L	L	H	X	H

H = HIGH Voltage Level  
 L = LOW Voltage Level  
 X = Immaterial

### Logic Diagram

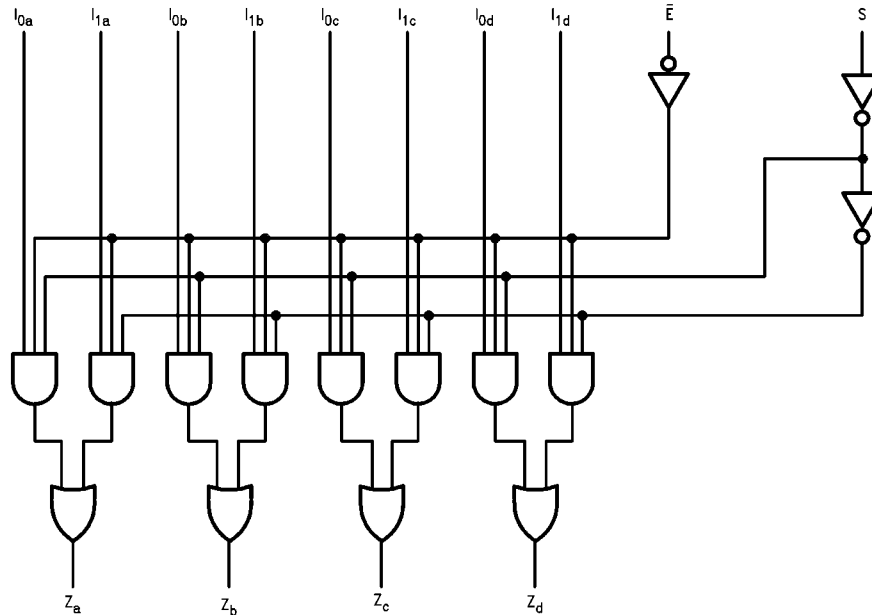

Please note that this diagram is provided only for the understanding of logic operations and should not be used to estimate propagation delays.

**Absolute Maximum Ratings**(Note 1)

Supply Voltage ( $V_{CC}$ )	-0.5V to +7.0V
DC Input Diode Current ( $I_{IK}$ )	
$V_I = -0.5V$	-20 mA
$V_I = V_{CC} + 0.5V$	+20 mA
DC Input Voltage ( $V_I$ )	-0.5V to $V_{CC} + 0.5V$
DC Output Diode Current ( $I_{OK}$ )	
$V_O = -0.5V$	-20 mA
$V_O = V_{CC} + 0.5V$	+20 mA
DC Output Voltage ( $V_O$ )	-0.5V to $V_{CC} + 0.5V$
DC Output Source or Sink Current ( $I_O$ )	$\pm 50$ mA
DC $V_{CC}$ or Ground Current per Output Pin ( $I_{CC}$ or $I_{GND}$ )	$\pm 50$ mA
Storage Temperature ( $T_{STG}$ )	-65°C to +150°C
Junction Temperature ( $T_J$ )	
PDIP	140°C

**Recommended Operating Conditions**

Supply Voltage ( $V_{CC}$ )	
AC	2.0V to 6.0V
ACT	4.5V to 5.5V
Input Voltage ( $V_I$ )	0V to $V_{CC}$
Output Voltage ( $V_O$ )	0V to $V_{CC}$
Operating Temperature ( $T_A$ )	-40°C to +85°C
Minimum Input Edge Rate ( $\Delta V/\Delta t$ )	
AC Devices	
$V_{IN}$ from 30% to 70% of $V_{CC}$	
$V_{CC}$ @ 3.3V, 4.5V, 5.5V	125 mV/ns
Minimum Input Edge Rate ( $\Delta V/\Delta t$ )	
ACT Devices	
$V_{IN}$ from 0.8V to 2.0V	
$V_{CC}$ @ 4.5V, 5.5V	125 mV/ns

**Note 1:** Absolute maximum ratings are those values beyond which damage to the device may occur. The databook specifications should be met, with-out exception, to ensure that the system design is reliable over its power supply, temperature, and output/input loading variables. Fairchild does not recommend operation of FACT™ circuits outside databook specifications.

**DC Electrical Characteristics for AC**

Symbol	Parameter	$V_{CC}$ (V)	$T_A = +25^\circ\text{C}$		$T_A = -40^\circ\text{C to } +85^\circ\text{C}$		Units	Conditions
			Typ	Guaranteed Limits	Typ	Guaranteed Limits		
$V_{IH}$	Minimum HIGH Level Input Voltage	3.0	1.5	2.1	2.1	V	$V_{OUT} = 0.1V$ or $V_{CC} - 0.1V$	
		4.5	2.25	3.15	3.15			
		5.5	2.75	3.85	3.85			
$V_{IL}$	Maximum LOW Level Input Voltage	3.0	1.5	0.9	0.9	V	$V_{OUT} = 0.1V$ or $V_{CC} - 0.1V$	
		4.5	2.25	1.35	1.35			
		5.5	2.75	1.65	1.65			
$V_{OH}$	Minimum HIGH Level Output Voltage	3.0	2.99	2.9	2.9	V	$I_{OUT} = -50 \mu A$	
		4.5	4.49	4.4	4.4			
		5.5	5.49	5.4	5.4			
		3.0		2.56	2.46	V	$V_{IN} = V_{IL}$ or $V_{IH}$ $I_{OH} = -12$ mA $I_{OH} = -24$ mA $I_{OH} = -24$ mA (Note 2)	
		4.5		3.86	3.76			
		5.5		4.86	4.76			
$V_{OL}$	Maximum LOW Level Output Voltage	3.0	0.002	0.1	0.1	V	$I_{OUT} = 50 \mu A$	
		4.5	0.001	0.1	0.1			
		5.5	0.001	0.1	0.1			
		3.0		0.36	0.44	V	$V_{IN} = V_{IL}$ or $V_{IH}$ $I_{OL} = 12$ mA $I_{OL} = 24$ mA $I_{OL} = 24$ mA (Note 2)	
		4.5		0.36	0.44			
		5.5		0.36	0.44			
$I_{IN}$ (Note 4)	Maximum Input Leakage Current	5.5		$\pm 0.1$	$\pm 1.0$	$\mu A$	$V_I = V_{CC}, GND$	
$I_{OLD}$	Minimum Dynamic	5.5			75	mA	$V_{OLD} = 1.65V$ Max	
$I_{OHD}$	Output Current (Note 3)	5.5			-75	mA	$V_{OHD} = 3.85V$ Min	
$I_{CC}$ (Note 4)	Maximum Quiescent Supply Current	5.5		4.0	40.0	$\mu A$	$V_{IN} = V_{CC}$ or GND	

**Note 2:** All outputs loaded; thresholds on input associated with output under test.

**Note 3:** Maximum test duration 2.0 ms, one output loaded at a time.

**Note 4:**  $I_{IN}$  and  $I_{CC}$  @ 3.0V are guaranteed to be less than or equal to the respective limit @ 5.5V  $V_{CC}$ .

## DC Characteristics for ACT

Symbol	Parameter	V <sub>CC</sub> (V)	T <sub>A</sub> = +25°C		T <sub>A</sub> = -40°C to +85°C		Units	Conditions
			Typ	Guaranteed Limits				
V <sub>IH</sub>	Minimum HIGH Level Input Voltage	4.5	1.5	2.0	2.0	V	V <sub>OUT</sub> = 0.1V or V <sub>CC</sub> - 0.1V	
		5.5	1.5	2.0	2.0			
V <sub>IL</sub>	Maximum LOW Level Input Voltage	4.5	1.5	0.8	0.8	V	V <sub>OUT</sub> = 0.1V or V <sub>CC</sub> - 0.1V	
		5.5	1.5	0.8	0.8			
V <sub>OH</sub>	Minimum HIGH Level Output Voltage	4.5	4.49	4.4	4.4	V	I <sub>OUT</sub> = -50 μA	
		5.5	5.49	5.4	5.4			
		4.5		3.86	3.76	V	V <sub>IN</sub> = V <sub>IL</sub> or V <sub>IH</sub> I <sub>OH</sub> = -24 mA I <sub>OH</sub> = -24 mA (Note 5)	
		5.5		4.86	4.76			
V <sub>OL</sub>	Maximum LOW Level Output Voltage	4.5	0.001	0.1	0.1	V	I <sub>OUT</sub> = 50 μA	
		5.5	0.001	0.1	0.1			
		4.5		0.36	0.44	V	V <sub>IN</sub> = V <sub>IL</sub> or V <sub>IH</sub> I <sub>OL</sub> = 24 mA I <sub>OL</sub> = 24 mA (Note 5)	
		5.5		0.36	0.44			
I <sub>IN</sub>	Maximum Input Leakage Current	5.5		±0.1	±1.0	μA	V <sub>I</sub> = V <sub>CC</sub> , GND	
I <sub>CCT</sub>	Maximum I <sub>CC</sub> /Input	5.5	0.6		1.5	mA	V <sub>I</sub> = V <sub>CC</sub> - 2.1V	
I <sub>OLD</sub>	Minimum Dynamic	5.5			75	mA	V <sub>OLD</sub> = 1.65V Max	
I <sub>OHD</sub>	Output Current (Note 6)	5.5			-75	mA	V <sub>OHD</sub> = 3.85V Min	
I <sub>CC</sub>	Maximum Quiescent Supply Current	5.5		4.0	40.0	μA	V <sub>IN</sub> = V <sub>CC</sub> or GND	

**Note 5:** All outputs loaded; thresholds on input associated with output under test.

**Note 6:** Maximum test duration 2.0 ms, one output loaded at a time.

## AC Electrical Characteristics for AC

Symbol	Parameter	V <sub>CC</sub> (V) (Note 7)	T <sub>A</sub> = +25°C C <sub>L</sub> = 50 pF			T <sub>A</sub> = -40°C to +85°C C <sub>L</sub> = 50 pF		Units
			Min	Typ	Max	Min	Max	
t <sub>PLH</sub>	Propagation Delay S to Z <sub>n</sub>	3.3	1.5	7.0	11.5	1.5	13.0	ns
		5.0	1.5	5.5	9.0	1.5	10.0	
t <sub>PHL</sub>	Propagation Delay S to Z <sub>n</sub>	3.3	1.5	6.5	11.0	1.5	12.0	ns
		5.0	1.5	5.0	8.5	1.0	9.5	
t <sub>PLH</sub>	Propagation Delay $\bar{E}$ to Z <sub>n</sub>	3.3	1.5	7.0	11.5	1.5	13.0	ns
		5.0	1.5	5.5	9.0	1.5	10.0	
t <sub>PHL</sub>	Propagation Delay $\bar{E}$ to Z <sub>n</sub>	3.3	1.5	6.5	11.0	1.5	12.0	ns
		5.0	1.5	5.5	9.0	1.0	9.5	
t <sub>PLH</sub>	Propagation Delay I <sub>n</sub> to Z <sub>n</sub>	3.3	1.5	5.0	8.5	1.0	9.0	ns
		5.0	1.5	4.0	6.5	1.0	7.0	
t <sub>PHL</sub>	Propagation Delay I <sub>n</sub> to Z <sub>n</sub>	3.3	1.5	5.0	8.0	1.0	9.0	ns
		5.0	1.5	4.0	6.5	1.0	7.0	

**Note 7:** Voltage Range 3.3 is 3.3V ± 0.3V

Voltage Range 5.0 is 5.0V ± 0.5V

### AC Electrical Characteristics for ACT

Symbol	Parameter	V <sub>CC</sub> (V) (Note 8)	T <sub>A</sub> = +25°C C <sub>L</sub> = 50 pF			T <sub>A</sub> = -40°C to +85°C C <sub>L</sub> = 50 pF		Units
			Min	Typ	Max	Min	Max	
t <sub>PLH</sub>	Propagation Delay S to Z <sub>n</sub>	5.0	2.0	5.5	9.0	1.5	10.0	ns
t <sub>PHL</sub>	Propagation Delay S to Z <sub>n</sub>	5.0	2.0	5.5	9.5	2.0	10.5	ns
t <sub>PLH</sub>	Propagation Delay $\bar{E}$ to Z <sub>n</sub>	5.0	1.5	6.0	10.0	1.5	11.5	ns
t <sub>PHL</sub>	Propagation Delay $\bar{E}$ to Z <sub>n</sub>	5.0	1.5	5.0	8.5	1.0	9.0	ns
t <sub>PLH</sub>	Propagation Delay I <sub>n</sub> to Z <sub>n</sub>	5.0	1.5	4.0	7.0	1.0	8.5	ns
t <sub>PHL</sub>	Propagation Delay I <sub>n</sub> to Z <sub>n</sub>	5.0	1.5	4.5	7.5	1.0	8.5	ns

**Note 8:** Voltage Range 5.0 is 5.0V ± 0.5V

### Capacitance

Symbol	Parameter	Typ	Units	Conditions
C <sub>IN</sub>	Input Capacitance	4.5	pF	V <sub>CC</sub> = OPEN
C <sub>PD</sub>	Power Dissipation Capacitance	50.0	pF	V <sub>CC</sub> = 5.0V

**Physical Dimensions** inches (millimeters) unless otherwise noted



**16-Lead Small Outline Integrated Circuit (SOIC), JEDEC MS-012, 0.150" Narrow Body  
Package Number M16A**

**Physical Dimensions** inches (millimeters) unless otherwise noted (Continued)

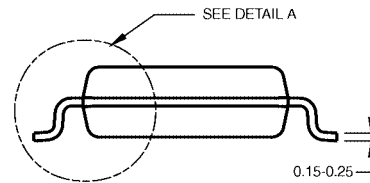
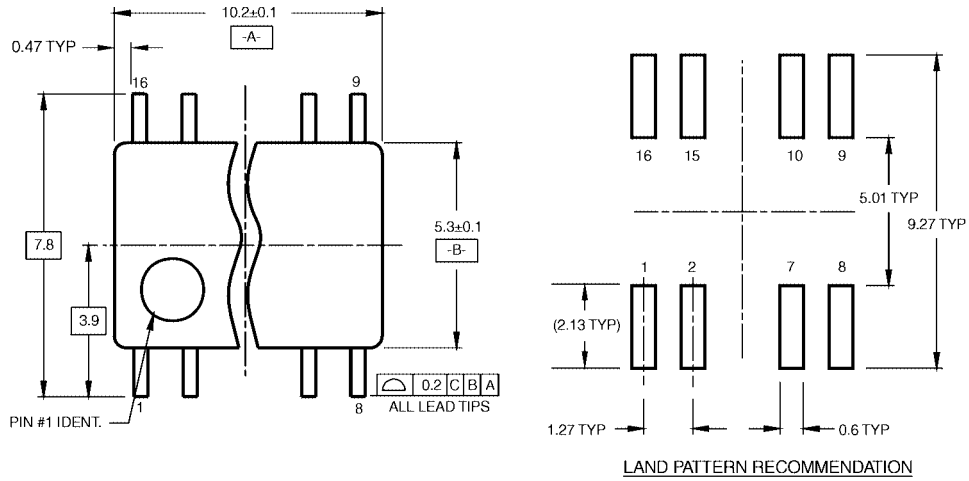

DIMENSIONS ARE IN MILLIMETERS

- NOTES:  
 A. CONFORMS TO EIAJ EDR-7320 REGISTRATION, ESTABLISHED IN DECEMBER, 1998.  
 B. DIMENSIONS ARE IN MILLIMETERS.  
 C. DIMENSIONS ARE EXCLUSIVE OF BURRS, MOLD FLASH, AND TIE BAR EXTRUSIONS.

M16DRevB1



**16-Lead Small Outline Package (SOP), EIAJ TYPE II, 5.3mm Wide  
 Package Number M16D**

**Physical Dimensions** inches (millimeters) unless otherwise noted (Continued)

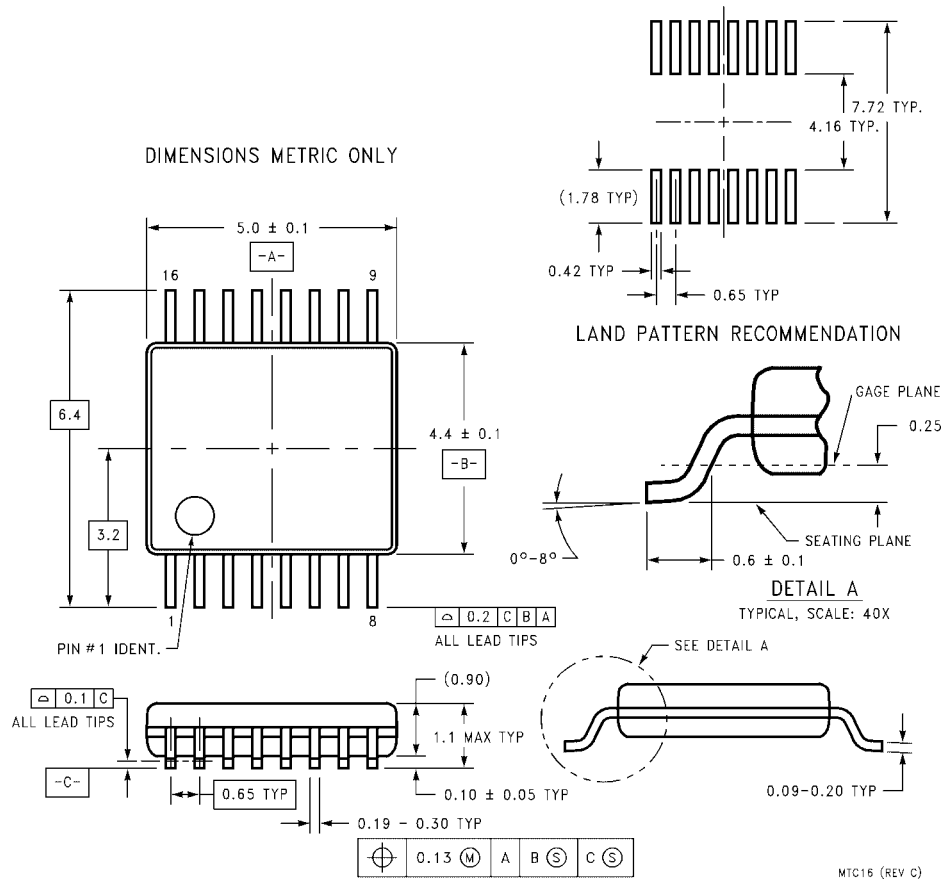

**16- Lead Thin Shrink Small Outline Package (TSSOP), JEDEC MO-153, 4.4mm Wide  
Package Number MTC16**

MTC16 (REV C)

**Physical Dimensions** inches (millimeters) unless otherwise noted (Continued)



**16-Lead Plastic Dual-In-Line Package (PDIP), JEDEC MS-001, 0.300" Wide Package Number N16E**

N16E (REV F)

Fairchild does not assume any responsibility for use of any circuitry described, no circuit patent licenses are implied and Fairchild reserves the right at any time without notice to change said circuitry and specifications.

**LIFE SUPPORT POLICY**

FAIRCHILD'S PRODUCTS ARE NOT AUTHORIZED FOR USE AS CRITICAL COMPONENTS IN LIFE SUPPORT DEVICES OR SYSTEMS WITHOUT THE EXPRESS WRITTEN APPROVAL OF THE PRESIDENT OF FAIRCHILD SEMICONDUCTOR CORPORATION. As used herein:

1. Life support devices or systems are devices or systems which, (a) are intended for surgical implant into the body, or (b) support or sustain life, and (c) whose failure to perform when properly used in accordance with instructions for use provided in the labeling, can be reasonably expected to result in a significant injury to the user.
2. A critical component in any component of a life support device or system whose failure to perform can be reasonably expected to cause the failure of the life support device or system, or to affect its safety or effectiveness.

[www.fairchildsemi.com](http://www.fairchildsemi.com)

## Looking for pricing, stock, or lifecycle information?

Click below to explore more details on WIN SOURCE:

 [View 74ACT157SCX on WIN SOURCE](#)

 [Fairchild/ON Semiconductor](#) Information

## Optimize Your Supply Chain with WIN SOURCE Solutions

-  Global Sourcing Solution
-  Obsolete Management
-  Cost Control Management
-  Shortage Management
-  Alternative Solution
-  Excess Inventory Management