



**THE DATASHEET OF
SG6859DTY**



SG6859D

Low-Cost, Green-Mode PWM Controller for Flyback Converters

Features

- Green-Mode PWM
- Supports the “Blue Angel” Standard
- Low Startup Current: 9µA
- Low Operating Current: 3mA
- 300mA Driving Capability
- Leading-Edge Blanking
- Constant Output Power Limit
- Universal Input
- Built-in Synchronized Slope Compensation
- Current-Mode Operation
- Cycle-by-Cycle Current Limiting
- Under-Voltage Lockout (UVLO)
- Programmable PWM Frequency with Frequency Hopping
- V_{DD} Over-Voltage Protection (Auto Restart)
- Gate Output Voltage Clamped at 17V
- Low Cost
- Few External Components Required
- Small SSOT-6 Package

Description

This highly integrated PWM controller provides several enhancements designed to meet the low standby-power needs of low-power SMPS. To minimize standby power consumption, the proprietary green-mode function provides off-time modulation to linearly decrease the switching frequency under light-load conditions. This green-mode function enables the power supply to meet even the strictest power conservation requirements.

The BiCMOS fabrication process enables reducing the startup current to 9µA and the operating current to 3mA. To further improve power conservation, a large startup resistance can be used. Built-in synchronized slope compensation ensures the stability of peak current mode control. Proprietary internal compensation provides a constant output power limit over a universal AC input range (90V_{AC} to 264V_{AC}). Pulse-by-pulse current limiting ensures safe operation during short-circuits.

To protect the external power MOSFET from damage by supply over voltage, the SG6859D’s output driver is clamped at 17V. SG6859D controllers can be used to improve the performance and reduce the production cost of power supplies. The best choice for replacing linear and RCC-mode power adapters. Available in 8-pin DIP and 6-pin SSOT-6 packages.

Applications

General-purpose switching mode power supplies and flyback power converters, such as:

- Battery chargers for cellular phones, cordless phones, PDAs, digital cameras, and power tools
- Power adapters for ink jet printers, video game consoles, and portable audio players
- Open-frame SMPS for TV/DVD standby and auxiliary supplies, home appliances, and consumer electronics
- Replacements for linear transformers and RCC SMPS
- PC 5V standby power

Ordering Information

Part Number	Operating Temperature Range	Package	 Eco Status	Packing Method
SG6859DTY	-40 to +105°C	SSOT-6	Green	Tape & reel
SG6859DDY		DIP-8		Tube

 For Fairchild’s definition of “green” Eco Status, please visit: http://www.fairchildsemi.com/company/green/rohs_green.html.

Application Diagram

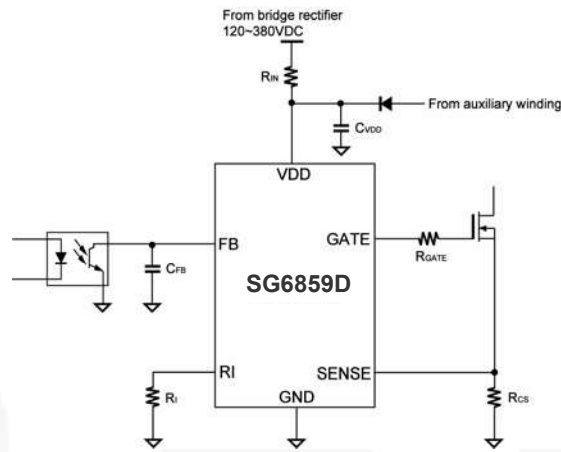

Figure 1. Typical Application

Internal Block Diagram

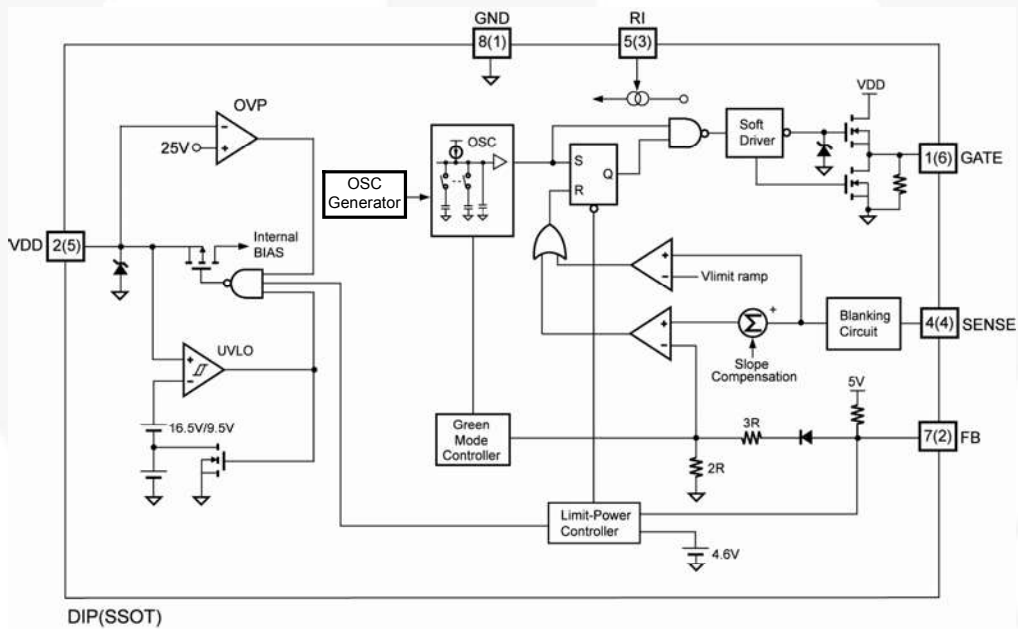
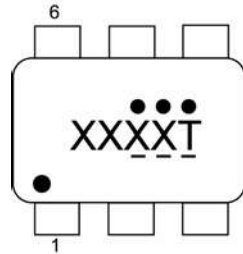

Figure 2. Functional Block Diagram

Marking Information



XXXX: ABBK=SG6859D
 T : Die Run Code
 . . . : Year Code
 - - - : Week Code

*Marking for SG6859DTY (Green compound)

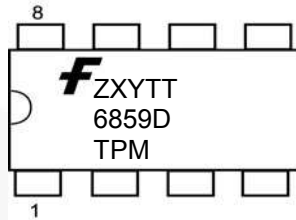

F- Fairchild Logo
 Z- Plant Code
 X- 1 Digit Year Code
 Y- 1 Digit Week Code
 TT: 2 Digits die Run Code
 T: Package Type (D=DIP)
 P: Y: Green Package
 M: Manufacture Flow Code

*Marking for SG6859DDY (Green compound)

Figure 3. Top Mark

Pin Configurations

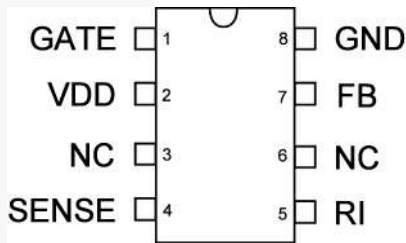

Figure 4. 8-Pin DIP

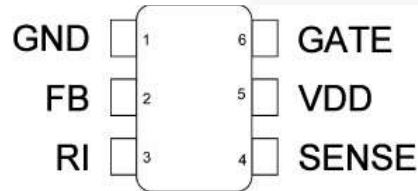

Figure 5. 6-Pin SSOT

Pin Definitions

DIP Pin #	SSOT Pin #	Name	Description
1	6	GATE	The totem-pole output driver for driving the power MOSFET.
2	5	VDD	Power Supply.
3		NC	No Connection.
4	4	SENSE	Current Sense. This pin senses the voltage across a resistor. When the voltage reaches the internal threshold, PWM output is disabled. This activates over-current protection. This pin provides current amplitude information for current-mode control.
5	3	RI	A resistor connected from the RI pin to ground generates a constant current source used to charge an internal capacitor and determine the switching frequency. Increasing the resistance reduces the amplitude of the current source and the switching frequency. A 95kΩ resistor R _i results in a 50μA constant current I _i and a 65kHz switching frequency.
6		NC	No Connection.
7	2	FB	Feedback. The FB pin provides the output voltage regulation signal. It provides feedback to the internal PWM comparator, so that the PWM comparator can control the duty cycle.
8	1	GND	Ground.

Absolute Maximum Ratings

Stresses exceeding the absolute maximum ratings may damage the device. The device may not function or be operable above the recommended operating conditions and stressing the parts to these levels is not recommended. In addition, extended exposure to stresses above the recommended operating conditions may affect device reliability. The absolute maximum ratings are stress ratings only.

Symbol	Parameter	Min.	Max.	Unit
V _{VDD}	DC Supply Voltage ^(1, 2)		30	V
V _{FB}	Input Voltage to FB Pin	-0.3	7.0	V
V _{SENSE}	Input Voltage to Sense Pin	-0.3	7.0	V
T _J	Operating Junction Temperature		150	°C
Θ _{JA}	Thermal Resistance (Junction-to-Air)	SSOT	208.4	°C/W
		DIP	82.5	°C/W
T _{STG}	Storage Temperature Range	-55	+150	°C
T _L	Lead Temperature (Wave Soldering or IR, 10 Seconds)		+260	°C
ESD	Electrostatic Discharge	Human Body Model, JEDEC:JESD22-A114	3.5	kV
		Charged Device Model, JEDEC:JESD22-C101	1.25	kV

Notes:

1. All voltage values, except differential voltages, are given with respect to GND pin.
2. Stresses beyond those listed under "absolute maximum ratings" may cause permanent damage to the device.

Electrical Characteristics

Unless otherwise noted, $V_{DD}=15V$ and $T_A=25^\circ C$.

Symbol	Parameter	Conditions	Min.	Typ.	Max.	Units	
V_{DD} Section							
V_{DD-OP}	Continuously Operation Voltage				22	V	
V_{DD-ON}	Turn-On Threshold Voltage		15.5	16.5	17.5	V	
V_{DD-OFF}	Turn-Off Threshold Voltage		8.5	9.5	10.5	V	
I_{DD-ST}	Startup Current	$V_{DD}=V_{DD-ON} - 0.1V$		9	15	μA	
I_{DD-OP}	Operating Supply Current	$V_{DD}=15V, C_L=1nF$		3.0	3.5	mA	
V_{DD-OVP}	V_{DD} Over-Voltage Protection Level	Auto Restart	24	25	26	V	
$t_{D-VDDOVP}$	V_{DD} Over-Voltage Protection Debounce	Auto Restart		125		μs	
Feedback Input Section							
Z_{FB}	Input Impedance			5		k Ω	
$V_{FB-OPEN}$	FB Output High Voltage	FB Pin Open	5			V	
V_{FB-OL}	FB Open-loop Trigger Level		4.3	4.6	4.9	V	
t_{D-OLP}	Delay of FB Pin Open-loop Protection	$R_I=95k\Omega$	53	58	63	ms	
V_{FB-N}	Green-Mode Entry FB Voltage		2.60	2.85	3.10	V	
V_{FB-G}	Green-Mode Ending FB Voltage			2.2		V	
V_{FB-ZDC}	Zero Duty-Cycle Input Voltage			1.8		V	
S_G	Green-Mode Modulation Slope	$R_I=95k\Omega$	40	60	80	Hz/mV	
Current-Sense Section							
Z_{SENSE}	Input Impedance		10			k Ω	
t_{PD}	Delay to Output		45	65	85	ns	
V_{STHFL}	Flat Threshold Voltage for Current Limit		0.95	1.01	1.06	V	
V_{STHVA}	Valley Threshold Voltage for Current Limit		0.75	0.80	0.85	V	
t_{LEB}	Leading-Edge Blanking Time		250	300	350	ns	
DCY_{SAW}	Duty Cycle of SAW Limit			30		%	
Oscillator Section							
f_{OSC}	Frequency	Center Frequency	$R_I=95k\Omega$	60	65	70	kHz
		Hopping Range			± 4		
t_{HOP}	Hopping Period	$R_I=95k\Omega$		4		ms	
f_{OSC-G}	Green-Mode Frequency	$R_I=95k\Omega$		22		kHz	
f_{DV}	Frequency Variation vs. V_{DD} Deviation	$V_{DD}=13.5$ to $22V$			5	%	
f_{DT}	Frequency Variation vs. Temperature Deviation	$T_A=-20$ to $85^\circ C$			5	%	
Output Section							
DCY_{MAX}	Maximum Duty Cycle		65	70	75	%	
V_{GATE-L}	Output Voltage Low	$V_{DD}=15V, I_O=20mA$			1.4	V	
V_{GATE-H}	Output Voltage High	$V_{DD}=13.5V, I_O=20mA$	8			V	
t_r	Rising Time	$V_{DD}=15V, C_L=1nF$	80	150	180	ns	
t_f	Falling Time	$V_{DD}=15V, C_L=1nF$	35	55	75	ns	
$V_{GATE-CLAMP}$	Output Clamp Voltage	$V_{DD}=22V$	16	17	18	V	

Typical Performance Characteristics

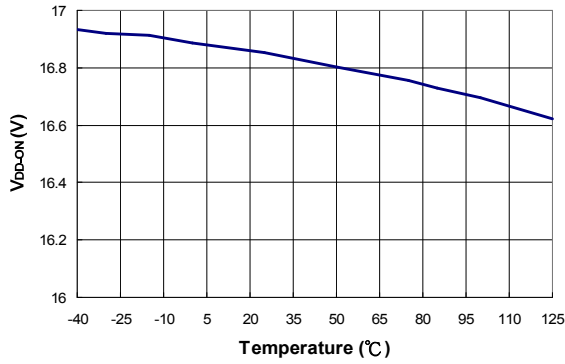

Figure 6. Turn-On Threshold Voltage (V_{DD-ON}) vs. Temperature

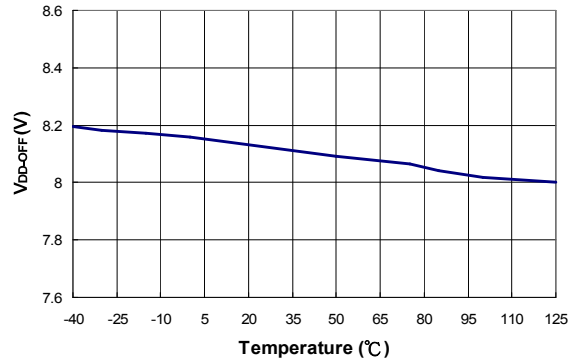

Figure 7. Turn-Off Threshold Voltage (V_{DD-OFF}) vs. Temperature

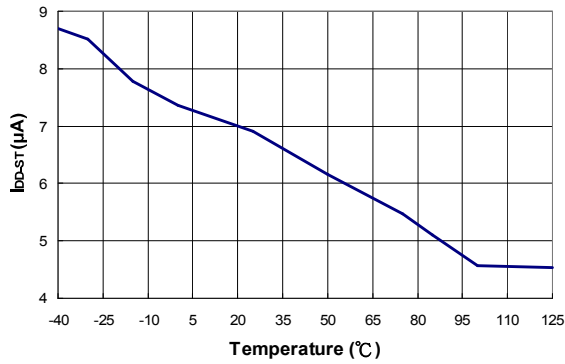

Figure 8. Startup Current (I_{DD-ST}) vs. Temperature

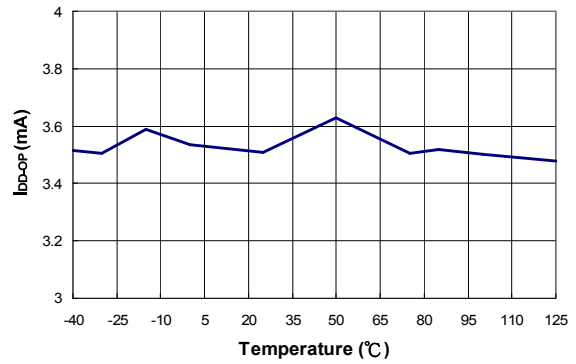

Figure 9. Operating Supply Current (I_{DD-OP}) vs. Temperature

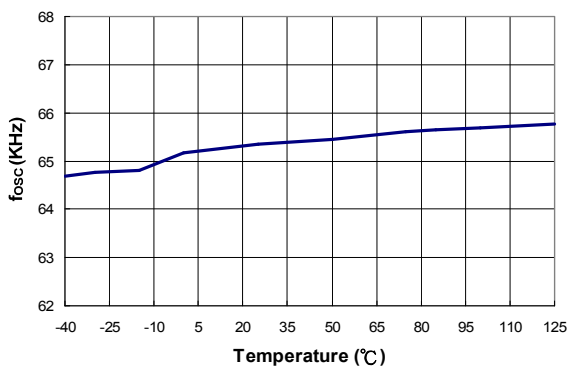

Figure 10. Center Frequency (f_{OSC}) vs. Temperature

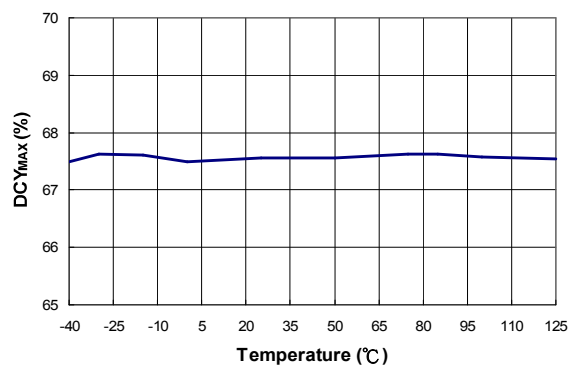

Figure 11. Maximum Duty Cycle (DCY_{MAX}) vs. Temperature

Typical Performance Characteristics

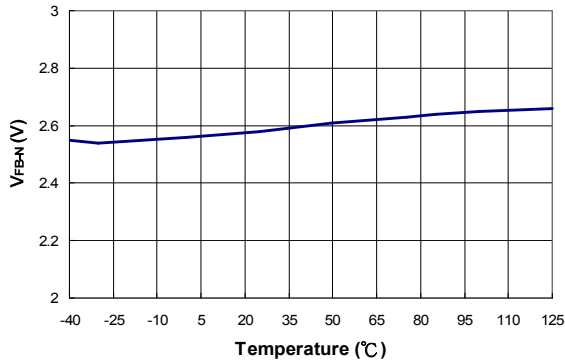

Figure 12. Green-Mode Entry FB Voltage (V_{FB-N}) vs. Temperature

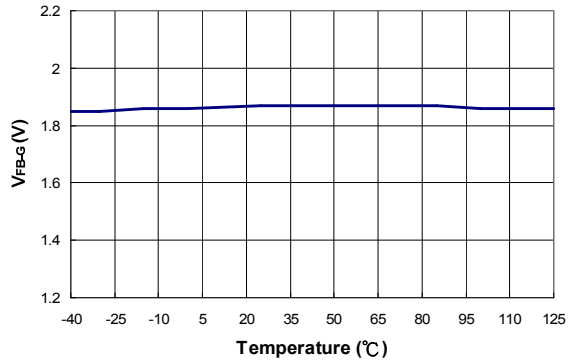

Figure 13. Green-Mode Ending FB Voltage (V_{FB-G}) vs. Temperature

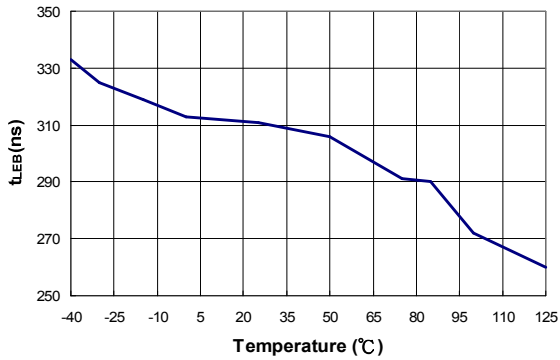

Figure 14. Leading-Edge Blanking Time (t_{LEB}) vs. Temperature

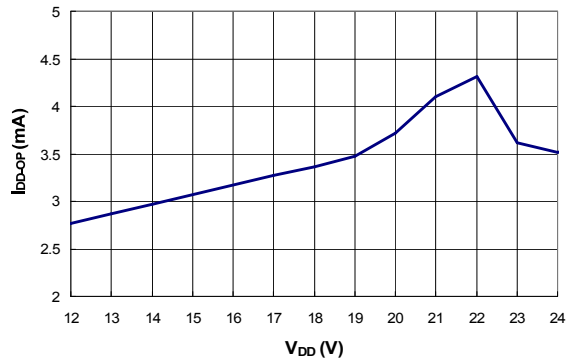

Figure 15. Operating Supply Current vs. V_{DD} Voltage

Operation Description

SG6859D devices integrate many useful designs into one controller for low-power, switch-mode power supplies. The following descriptions highlight some of the features of the SG6859D series.

Startup Current

The startup current is only 9 μ A. Low startup current allows a startup resistor with high resistance and low wattage to supply the startup power for the controller. A 1.5M Ω , 0.25W, startup resistor and a 10 μ F/25V V_{DD} hold-up capacitor are sufficient for an AC-to-DC power adapter with a wide input range (100V_{AC} to 240V_{AC}).

Operating Current

The operating current has been reduced to 3mA. The low operating current results in higher efficiency and reduces the V_{DD} hold-up capacitance requirement.

Green-Mode Operation

The proprietary green-mode function provides off-time modulation to linearly decrease the switching frequency under light-load conditions. On-time is limited to provide stronger protection against brownouts and other abnormal conditions. The feedback current, which is sampled from the voltage feedback loop, is taken as the reference. Once the feedback current exceeds the threshold current, the switching frequency starts to decrease. This green-mode function dramatically reduces power consumption under light-load and zero-load conditions. Power supplies using the SG6859D can meet even the strictest regulations regarding standby power consumption.

Oscillator Operation

A resistor connected from the RI pin to ground generates a constant current source used to charge an internal capacitor. The charge time determines the internal clock speed and the switching frequency. Increasing the resistance reduces the amplitude of the input current and the switching frequency. A 95k Ω R_I resistor results in a 50 μ A constant current I_I and a 65kHz switching frequency. The relationship between R_I and the switching frequency is:

$$f_{\text{PWM}} = \frac{6175}{R_I(\text{k}\Omega)} \text{ (kHz)} \quad (1)$$

Leading-Edge Blanking (LEB)

Each time the power MOSFET is switched on, a turn-on spike occurs at the sense-resistor. To avoid premature termination of the switching pulse, a 300ns leading-edge blanking time is built in. Conventional RC filtering can be omitted. During this blanking period, the current-limit comparator is disabled and cannot switch off the gate driver.

Constant Output Power Limit

When the SENSE voltage across the sense resistor, R_S , reaches the threshold voltage (around 1.01V), the output GATE drive is turned off following a short propagation delay, t_{PD} . This propagation delay introduces an additional current proportional to $t_{PD} \cdot V_{IN} / L_P$. The propagation delay is nearly constant, regardless of the input line voltage V_{IN} . Higher input line voltages result in larger additional currents. At high input line voltages, the output power limit is higher than at low input line voltages. To compensate for this output power limit variation across a wide AC input range, the threshold voltage is adjusted by adding a positive ramp. This ramp signal rises from 0.8V to 1.01V, then flattens out at 1.01V. A smaller threshold voltage forces the output GATE drive to terminate earlier, which reduces the total PWM turn-on time and makes the output power equal to that of low line input. This proprietary internal compensation ensures a constant output power limit for a wide AC input voltage range (90V_{AC} to 264V_{AC}).

Under-Voltage Lockout (UVLO)

The turn-on and -off thresholds are fixed internally at 16.5V and 9.5V. During startup, the hold-up capacitor must be charged to 16.5V through the startup resistor to enable the SG6859D. The hold-up capacitor continues to supply V_{DD} until power is delivered from the auxiliary winding of the main transformer. V_{DD} must not drop below 9.5V during this startup process. This UVLO hysteresis window ensures that hold-up capacitor is adequate to supply V_{DD} during startup.

Gate Output

The BiCMOS output stage is a fast totem pole gate driver. Cross conduction has been avoided to minimize heat dissipation, increase efficiency, and enhance reliability. The output driver is clamped by an internal 17V Zener diode to protect power MOSFET transistors against undesired over-voltage gate signals.

Built-In Slope Compensation

The sensed voltage across the current-sense resistor is used for current-mode control and pulse-by-pulse current limiting. Built-in slope compensation improves stability and prevents sub-harmonic oscillations due to peak-current mode control. The SG6859D has a synchronized, positively-sloped ramp built-in at each switching cycle.

Noise Immunity

Noise from the current sense or the control signal can cause significant pulse-width jitter, particularly in continuous-conduction mode (CCM). While slope compensation helps alleviate these problems, further precautions should still be taken. Good placement and layout practices should be followed. Avoiding long PCB traces and component leads, locating compensation and filter components near the SG6859D, and increasing power MOS gate resistance improve performance.



TRADEMARKS

The following includes registered and unregistered trademarks and service marks, owned by Fairchild Semiconductor and/or its global subsidiaries, and is not intended to be an exhaustive list of all such trademarks.

AccuPower™	F-PFS™		
AX-CAP®*	FRFET®	PowerTrench®	TinyBoost®
BitSiC™	Global Power Resource SM	PowerXS™	TinyBuck®
Build it Now™	GreenBridge™	Programmable Active Droop™	TinyCalc™
CorePLUS™	Green FPS™	QFET®	TinyLogic®
CorePOWER™	Green FPS™ e-Series™	QS™	TINYOPTO™
CROSSVOL™	Gmax™	Quiet Series™	TinyPower™
CTL™	GTO™	RapidConfigure™	TinyPWM™
Current Transfer Logic™	IntelliMAX™		TinyWire™
DEUXPEED®	ISOPLANAR™	Saving our world, 1mW/W/kW at a time™	TranSiC™
Dual Cool™	Making Small Speakers Sound Louder and Better™	SignalWise™	TriFault Detect™
EcoSPARK®	MegaBuck™	SmartMax™	TRUECURRENT®*
EfficientMax™	MICROCOUPLER™	SMART START™	μSerDes™
ESBC™	MicroFET™	Solutions for Your Success™	
	MicroPak™	SPM®	UHC®
Fairchild®	MicroPak2™	STEALTH™	Ultra FRFET™
Fairchild Semiconductor®	MillerDrive™	SuperFET®	UniFET™
FACT Quiet Series™	MotionMax™	SuperSOT™-3	VXC™
FACT®	mWSaver®	SuperSOT™-6	VisualMax™
FAST®	OptoHiT™	SuperSOT™-8	VoltagePlus™
FastvCore™	OPTOLOGIC®	SupreMOS®	XS™
FETBench™	OPTOPLANAR®	SyncFET™	仙童™
FPS™		Sync-Lock™	

* Trademarks of System General Corporation, used under license by Fairchild Semiconductor.

DISCLAIMER

FAIRCHILD SEMICONDUCTOR RESERVES THE RIGHT TO MAKE CHANGES WITHOUT FURTHER NOTICE TO ANY PRODUCTS HEREIN TO IMPROVE RELIABILITY, FUNCTION, OR DESIGN. FAIRCHILD DOES NOT ASSUME ANY LIABILITY ARISING OUT OF THE APPLICATION OR USE OF ANY PRODUCT OR CIRCUIT DESCRIBED HEREIN; NEITHER DOES IT CONVEY ANY LICENSE UNDER ITS PATENT RIGHTS, NOR THE RIGHTS OF OTHERS. THESE SPECIFICATIONS DO NOT EXPAND THE TERMS OF FAIRCHILD'S WORLDWIDE TERMS AND CONDITIONS, SPECIFICALLY THE WARRANTY THEREIN, WHICH COVERS THESE PRODUCTS.

LIFE SUPPORT POLICY

FAIRCHILD'S PRODUCTS ARE NOT AUTHORIZED FOR USE AS CRITICAL COMPONENTS IN LIFE SUPPORT DEVICES OR SYSTEMS WITHOUT THE EXPRESS WRITTEN APPROVAL OF FAIRCHILD SEMICONDUCTOR CORPORATION.

As used herein:

1. Life support devices or systems are devices or systems which, (a) are intended for surgical implant into the body or (b) support or sustain life, and (c) whose failure to perform when properly used in accordance with instructions for use provided in the labeling, can be reasonably expected to result in a significant injury of the user.
2. A critical component in any component of a life support, device, or system whose failure to perform can be reasonably expected to cause the failure of the life support device or system, or to affect its safety or effectiveness.

ANTI-COUNTERFEITING POLICY

Fairchild Semiconductor Corporation's Anti-Counterfeiting Policy. Fairchild's Anti-Counterfeiting Policy is also stated on our external website, www.fairchildsemi.com, under Sales Support.

Counterfeiting of semiconductor parts is a growing problem in the industry. All manufacturers of semiconductor products are experiencing counterfeiting of their parts. Customers who inadvertently purchase counterfeit parts experience many problems such as loss of brand reputation, substandard performance, failed applications, and increased cost of production and manufacturing delays. Fairchild is taking strong measures to protect ourselves and our customers from the proliferation of counterfeit parts. Fairchild strongly encourages customers to purchase Fairchild parts either directly from Fairchild or from Authorized Fairchild Distributors who are listed by country on our web page cited above. Products customers buy either from Fairchild directly or from Authorized Fairchild Distributors are genuine parts, have full traceability, meet Fairchild's quality standards for handling and storage and provide access to Fairchild's full range of up-to-date technical and product information. Fairchild and our Authorized Distributors will stand behind all warranties and will appropriately address any warranty issues that may arise. Fairchild will not provide any warranty coverage or other assistance for parts bought from Unauthorized Sources. Fairchild is committed to combat this global problem and encourage our customers to do their part in stopping this practice by buying direct or from authorized distributors.

PRODUCT STATUS DEFINITIONS

Definition of Terms

Datasheet Identification	Product Status	Definition
Advance Information	Formative / In Design	Datasheet contains the design specifications for product development. Specifications may change in any manner without notice.
Preliminary	First Production	Datasheet contains preliminary data; supplementary data will be published at a later date. Fairchild Semiconductor reserves the right to make changes at any time without notice to improve design.
No Identification Needed	Full Production	Datasheet contains final specifications. Fairchild Semiconductor reserves the right to make changes at any time without notice to improve the design.
Obsolete	Not In Production	Datasheet contains specifications on a product that is discontinued by Fairchild Semiconductor. The datasheet is for reference information only.

Rev. I68

Looking for pricing, stock, or lifecycle information?

Click below to explore more details on WIN SOURCE:

 [View SG6859DTY on WIN SOURCE](#)

 [ON Semiconductor](#) Information

Optimize Your Supply Chain with WIN SOURCE Solutions

-  Global Sourcing Solution
-  Obsolete Management
-  Cost Control Management
-  Shortage Management
-  Alternative Solution
-  Excess Inventory Management