



**THE DATASHEET OF
74ALVC162835ADGG:1**



74ALVC162835A

18-bit registered driver with 30 Ω termination resistors;
3-state

Rev. 7 — 12 October 2017

Product data sheet

1 General description

The 74ALVC162835A is an 18-bit universal bus driver. Data flow is controlled by output enable (\overline{OE}), latch enable (LE) and clock inputs (CP).

When LE is HIGH, the A to Y data flow is transparent. When LE is LOW and CP is held at LOW or HIGH, the data is latched; on the LOW to HIGH transient of CP the A-data is stored in the latch/flip-flop.

When \overline{OE} is LOW the outputs are active. When \overline{OE} is HIGH, the outputs go to the high impedance OFF-state. Operation of the \overline{OE} input does not affect the state of the latch/flip-flop.

To ensure the high-impedance state during power up or power down, \overline{OE} should be tied to V_{CC} through a pull-up resistor; the minimum value of the resistor is determined by the current-sinking capability of the driver.

The 74ALVC162835A is designed with 30 Ω series resistors in both HIGH or LOW output stages.

2 Features and benefits

- Wide supply voltage range from 1.2 V to 3.6 V
- CMOS low-power consumption
- Direct interface with TTL levels
- Current drive ± 12 mA at 3.0 V
- MULTIBYTE flow-through standard pin-out architecture
- Low inductance multiple V_{CC} and GND pins for minimum noise and ground bounce
- Output drive capability 50 Ω transmission lines at 85°C
- Integrated 30 Ω termination resistors
- Diode clamps to V_{CC} and GND on all inputs
- Input diodes to accommodate strong drivers
- Complies with JEDEC standard no. 8-1A

3 Ordering information

Table 1. Ordering information

Type number	Package			
	Temperature range	Name	Description	Version
74ALVC162835ADGG	-40 °C to + 85 °C	TSSOP56	plastic thin shrink small outline package; 56 leads; body width 6.1 mm	SOT364-1

4 Functional diagram

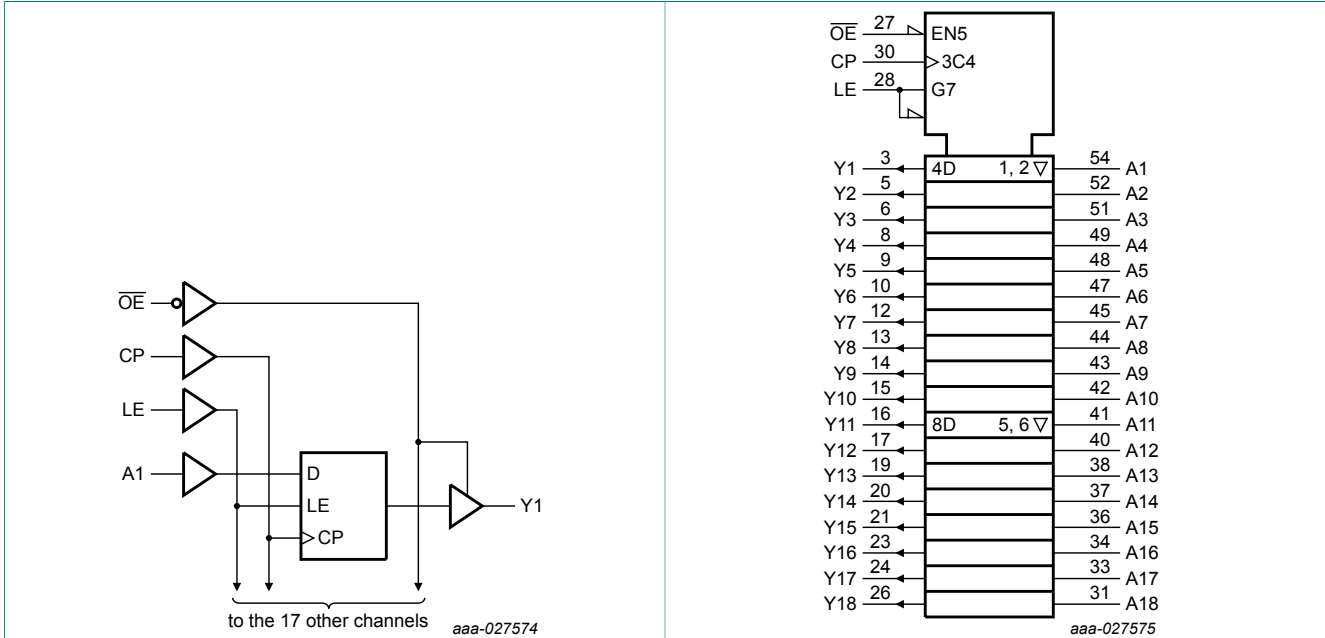

Figure 1. Logic diagram

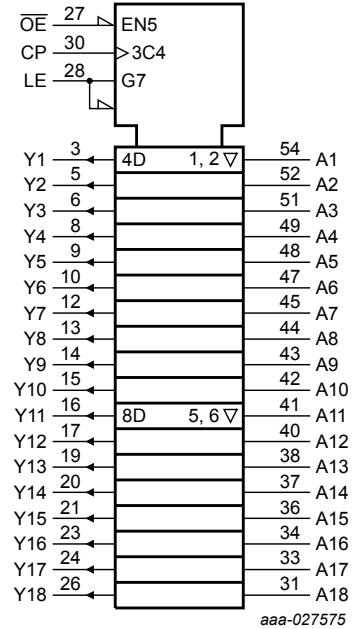

Figure 2. Logic symbol (IEEE/IEC)

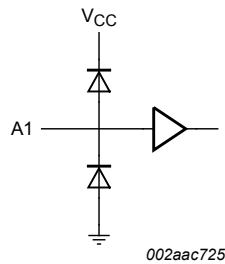

Figure 3. Typical input (data or control)

5 Pinning information

5.1 Pinning

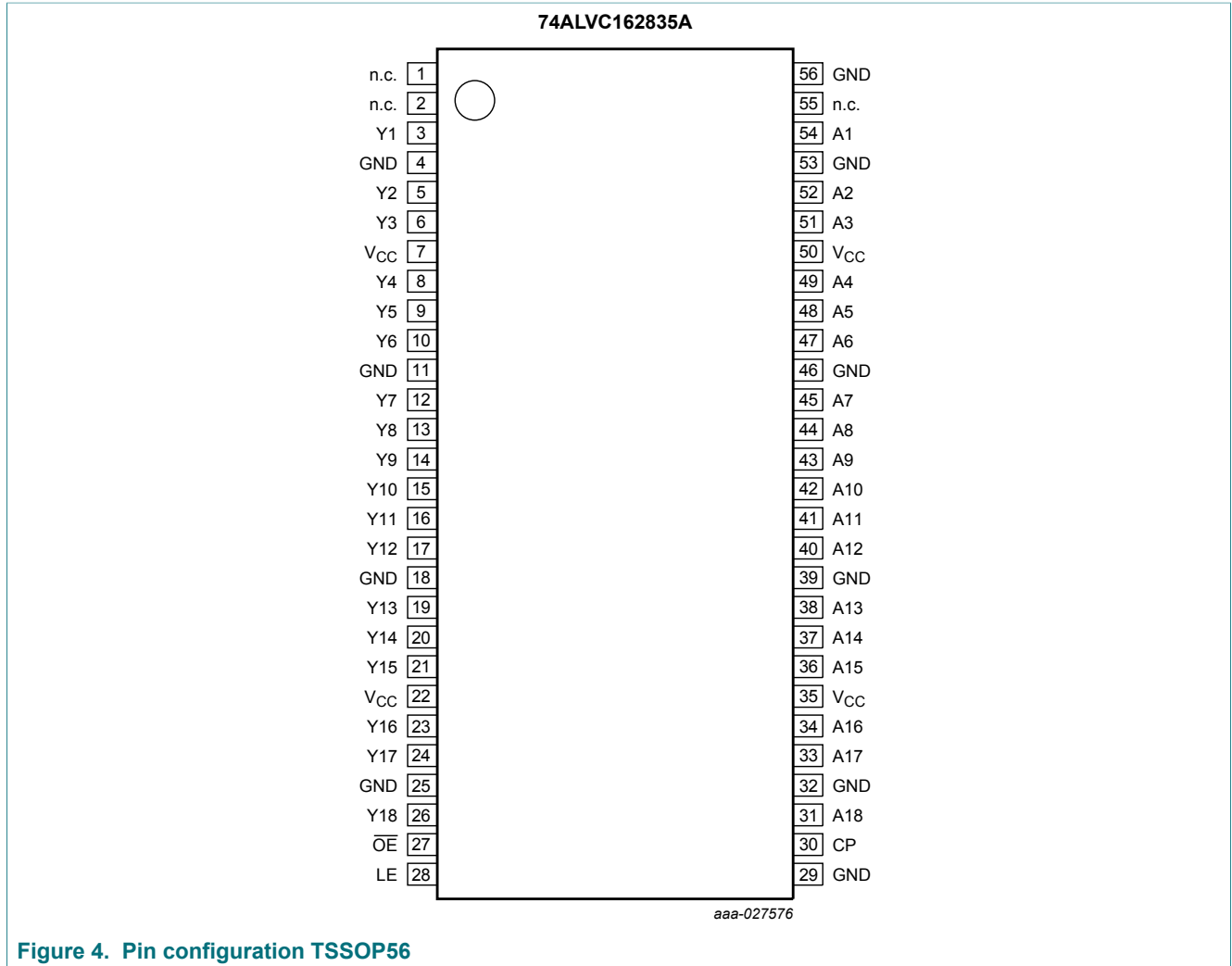

Figure 4. Pin configuration TSSOP56

5.2 Pin description

Table 2. Pin description

Symbol	Pin	Description
A1, A2, A3, A4, A5, A6, A7, A8, A9, A10, A11, A12, A13, A14, A15, A16, A17, A18	54, 52, 51, 49, 48, 47, 45, 44, 43, 42, 41, 40, 38, 37, 36, 34, 33, 31	data inputs
Y1, Y2, Y3, Y4, Y5, Y6, Y7, Y8, Y9, Y10, Y11, Y12, Y13, Y14, Y15, Y16, Y17, Y18	3, 5, 6, 8, 9, 10, 12, 13, 14, 15, 16, 17, 19, 20, 21, 23, 24, 26	data outputs
n.c.	1, 2, 55	no connected
LE	28	latch enable input (active HIGH)
OE	27	output enable input (active LOW)
CP	30	clock input
GND	4, 11, 18, 25, 32, 39, 46, 53, 56	ground (0 V)
V _{CC}	7, 22, 35, 50	supply voltage

6 Functional description

Table 3. Function table ^[1]

Input				Output
OE	LE	CP	An	Yn
H	X	X	X	Z
L	H	X	L	L
L	H	X	H	H
L	L	↑	L	L
L	L	↑	H	H
L	L	H	X	Yn ^[2]
L	L	L	X	Yn ^[3]

- [1] H = HIGH voltage level;
 L = LOW voltage level;
 X = don't care;
 Z = high-impedance OFF-state;
 ↑ = LOW-to-HIGH clock transition.

[2] Yn = Output level before the indicated steady-state input conditions were established, provided that CP is high before LE goes low.

[3] Yn = Output level before the indicated steady-state input conditions were established.

7 Limiting values

Table 4. Limiting values

In accordance with the Absolute Maximum Rating System (IEC 60134). Voltages are referenced to GND (ground = 0 V).

Symbol	Parameter	Conditions	Min	Max	Unit
V_{CC}	supply voltage		-0.5	+4.6	V
V_I	input voltage		[1] -0.5	+4.6	V
V_O	output voltage		[1] -0.5	$V_{CC} + 0.5$	V
I_{IK}	input clamping current	$V_I < 0$ V	-50	-	mA
I_{OK}	output clamping current	$V_O > V_{CC}$ or $V_O < 0$ V	-	± 50	mA
$I_{O(sink/source)}$	output sink or source current	$V_O = 0$ V to V_{CC}	-	± 50	mA
I_{CC}	supply current		-	+100	mA
I_{GND}	ground current		-100	-	mA
T_{stg}	storage temperature		-65	+150	$^{\circ}$ C
P_{tot}	total power dissipation		[2] -	600	mW

[1] The input and output voltage ratings may be exceeded if the input and output current ratings are observed.

[2] For TSSOP56 package: P_{tot} derates linearly with 8 mW/K above 55 $^{\circ}$ C.

8 Recommended operating conditions

Table 5. Recommended operating conditions

Symbol	Parameter	Conditions	Min	Typ	Max	Unit
V_{CC}	supply voltage	2.5 V range for maximum speed performance at 30 pF output load	2.3	-	2.7	V
		3.3 V range for maximum speed performance at 50 pF output load	3.0	-	3.6	V
		for low-voltage applications	1.2	-	3.6	V
V_I	input voltage		0	-	V_{CC}	V
V_O	output voltage		0	-	V_{CC}	V
T_{amb}	ambient temperature	operating in free-air	-40	-	+85	$^{\circ}$ C
$\Delta t/\Delta V$	input transition rise and fall rate	$V_{CC} = 2.3$ V to 3.0 V	0	-	20	ns/V
		$V_{CC} = 3.0$ V to 3.6 V	0	-	10	ns/V

9 Static characteristics

Table 6. Static characteristics

At recommended operating conditions; voltages are referenced to GND (ground = 0 V).

Symbol	Parameter	Conditions	Min	Typ ^[1]	Max	Unit	
V _{IH}	HIGH-level input voltage	V _{CC} = 2.3 V to 2.7 V	1.7	1.2	-	V	
		V _{CC} = 2.7 V to 3.6 V	2.0	1.5	-	V	
V _{IL}	LOW-level input voltage	V _{CC} = 2.3 V to 2.7 V	-	1.2	0.7	V	
		V _{CC} = 2.7 V to 3.6 V	-	1.5	0.8	V	
V _{OH}	HIGH-level output voltage	V _I = V _{IH} or V _{IL}					
		V _{CC} = 2.3 V to 3.6 V; I _O = -100 μ A	V _{CC} - 0.2	V _{CC}	-	V	
		V _{CC} = 2.3 V; I _O = -4 mA	V _{CC} - 0.4	V _{CC} - 0.11	-	V	
		V _{CC} = 2.3 V; I _O = -6 mA	V _{CC} - 0.6	V _{CC} - 0.17	-	V	
		V _{CC} = 2.7 V; I _O = -4 mA	V _{CC} - 0.5	V _{CC} - 0.09	-	V	
		V _{CC} = 2.7 V; I _O = -8 mA	V _{CC} - 0.7	V _{CC} - 0.19	-	V	
		V _{CC} = 3.0 V; I _O = -6 mA	V _{CC} - 0.6	V _{CC} - 0.13	-	V	
V _{OL}	LOW-level output voltage	V _I = V _{IH} or V _{IL}					
		V _{CC} = 2.3 V to 3.6 V; I _O = 100 μ A	-	GND	0.20	V	
		V _{CC} = 2.3 V; I _O = 4 mA	-	0.07	0.40	V	
		V _{CC} = 2.3 V; I _O = 6 mA	-	0.11	0.55	V	
		V _{CC} = 2.7 V; I _O = 4 mA	-	0.06	0.40	V	
		V _{CC} = 2.7 V; I _O = 8 mA	-	0.13	0.60	V	
		V _{CC} = 3.0 V; I _O = 6 mA	-	0.09	0.55	V	
I _I	input leakage current	V _{CC} = 2.3 V to 3.6 V; V _I = V _{CC} or GND	-	0.1	5	μ A	
		V _{CC} = 2.3 V to 3.6 V; V _I = V _{IH} or V _{IL} ; V _O = V _{CC} or GND	V _{CC} = 2.3 V; I _O = 100 μ A	-	0.1	10	μ A
			V _{CC} = 2.3 V; I _O = 4 mA	-	0.1	10	μ A
			V _{CC} = 2.3 V; I _O = 6 mA	-	0.1	10	μ A
			V _{CC} = 2.7 V; I _O = 4 mA	-	0.1	10	μ A
			V _{CC} = 2.7 V; I _O = 8 mA	-	0.1	10	μ A
			V _{CC} = 3.0 V; I _O = 6 mA	-	0.1	10	μ A
V _{CC} = 3.0 V; I _O = 12 mA	-	0.1	10	μ A			
I _{CC}	supply current	V _{CC} = 2.3 V to 3.6 V; V _I = V _{CC} or GND; I _O = 0 A	-	0.2	40	μ A	
Δ I _{CC}	additional supply current	V _{CC} = 2.3 V to 3.6 V; V _I = V _{CC} - 0.6 V; I _O = 0 A	-	150	750	μ A	
C _i	input capacitance		-	4.0	-	pF	
C _O	output capacitance		-	8.0	-	pF	

[1] Typical values are measured at T_{amb} = 25 °C

10 Dynamic characteristics

Table 7. Dynamic characteristics

Voltages are referenced to GND (ground = 0 V). For test circuit, see [Figure 11](#).

Symbol	Parameter	Conditions	Min	Typ ^[1]	Max	Unit
t_{pd}	propagation delay	An to Yn; Figure 5 ^[2]				
		$V_{CC} = 2.3 \text{ V to } 2.7 \text{ V}$	1.0	3.5	5.0	ns
		$V_{CC} = 2.7 \text{ V}$	1.0	3.3	5.0	ns
		$V_{CC} = 3.0 \text{ V to } 3.6 \text{ V}$	1.0	2.9	4.2	ns
		LE to Yn; Figure 6 ^[2]				
		$V_{CC} = 2.3 \text{ V to } 2.7 \text{ V}$	1.3	4.1	5.9	ns
		$V_{CC} = 2.7 \text{ V}$	1.3	3.8	5.8	ns
		$V_{CC} = 3.0 \text{ V to } 3.6 \text{ V}$	1.3	3.4	5.1	ns
		CP to Yn; Figure 8 ^[2]				
		$V_{CC} = 2.3 \text{ V to } 2.7 \text{ V}$	1.4	4.0	6.3	ns
		$V_{CC} = 2.7 \text{ V}$	1.4	3.7	6.1	ns
		$V_{CC} = 3.0 \text{ V to } 3.6 \text{ V}$	1.4	3.3	5.4	ns
t_{en}	enable time	\overline{OE} to Yn; Figure 10 ^[3]				
		$V_{CC} = 2.3 \text{ V to } 2.7 \text{ V}$	1.4	3.8	6.3	ns
		$V_{CC} = 2.7 \text{ V}$	1.1	4.0	6.5	ns
		$V_{CC} = 3.0 \text{ V to } 3.6 \text{ V}$	1.1	3.4	5.5	ns
t_{dis}	disable time	\overline{OE} to Yn; Figure 10 ^[4]				
		$V_{CC} = 2.3 \text{ V to } 2.7 \text{ V}$	1.0	2.6	4.9	ns
		$V_{CC} = 2.7 \text{ V}$	1.3	3.2	4.9	ns
		$V_{CC} = 3.0 \text{ V to } 3.6 \text{ V}$	1.3	3.0	4.5	ns
t_w	pulse width	CP HIGH or LOW; Figure 8				
		$V_{CC} = 2.3 \text{ V to } 2.7 \text{ V}$	3.3	1.0	-	ns
		$V_{CC} = 2.7 \text{ V}$	3.3	1.2	-	ns
		$V_{CC} = 3.0 \text{ V to } 3.6 \text{ V}$	3.3	0.7	-	ns
		LE HIGH; Figure 6				
		$V_{CC} = 2.3 \text{ V to } 2.7 \text{ V}$	3.3	0.7	-	ns
		$V_{CC} = 2.7 \text{ V}$	3.3	0.6	-	ns
		$V_{CC} = 3.0 \text{ V to } 3.6 \text{ V}$	3.3	0.6	-	ns
t_{su}	set-up time	An to CP; $V_{CC} = 2.3 \text{ V to } 3.6 \text{ V}$; Figure 9	1.0	-	-	ns
		An to LE; $V_{CC} = 2.3 \text{ V to } 3.6 \text{ V}$; Figure 7	1.5	-	-	ns

Symbol	Parameter	Conditions	Min	Typ ^[1]	Max	Unit
t _h	hold time	An to CP; Figure 9				
		V _{CC} = 2.3 V to 2.7 V	1.0	0.4	-	ns
		V _{CC} = 2.7 V	1.2	0.4	-	ns
		V _{CC} = 3.0 V to 3.6 V	0.9	0.7	-	ns
		An to LE; Figure 7				
		V _{CC} = 2.3 V to 2.7 V	0.5	0.1	-	ns
		V _{CC} = 2.7 V	1.0	0.1	-	ns
V _{CC} = 3.0 V to 3.6 V	1.0	0.4	-	ns		
f _{max}	maximum frequency	CP; Figure 8				
		V _{CC} = 2.3 V to 2.7 V	150	190	-	MHz
		V _{CC} = 2.7 V	150	190	-	MHz
		V _{CC} = 3.0 V to 3.6 V	150	240	-	MHz
C _{PD}	power dissipation capacitance	per buffer; V _I = GND to V _{CC} ^[5]				
		transparent mode; output enabled	-	10	-	pF
		transparent mode; output disabled	-	3	-	pF
		clocked mode; output enabled	-	21	-	pF
		clocked mode; output disabled	-	15	-	pF

[1] Typical values are measured at T_{amb} = 25 °C

Typical values for V_{CC} = 2.3 V to 2.7 V are measured at V_{CC} = 2.5 V

Typical values for V_{CC} = 3.0 V to 3.6 V are measured at V_{CC} = 3.3 V

[2] t_{pd} is the same as t_{PHL} and t_{PLH}.

[3] t_{en} is the same as t_{PZH} and t_{PZL}.

[4] t_{dis} is the same as t_{PHZ} and t_{PLZ}.

[5] C_{PD} is used to determine the dynamic power dissipation (P_D in μW):

$P_D = C_{PD} \times V_{CC}^2 \times f_i \times N + \sum(C_L \times V_{CC}^2 \times f_o)$ where:

f_i = input frequency in MHz;

f_o = output frequency in MHz;

C_L = output load capacitance in pF;

V_{CC} = supply voltage in V;

N = number of inputs switching;

$\sum(C_L \times V_{CC}^2 \times f_o)$ = sum of outputs.

10.1 Waveforms and test circuit

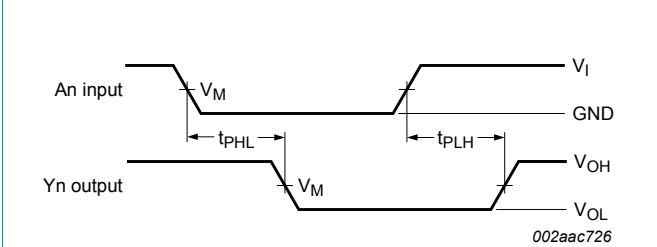

Measurement points are given in [Table 8](#). V_{OL} and V_{OH} are typical voltage output levels that occur with the output load.

Figure 5. Input (An) to output (Yn) propagation delay

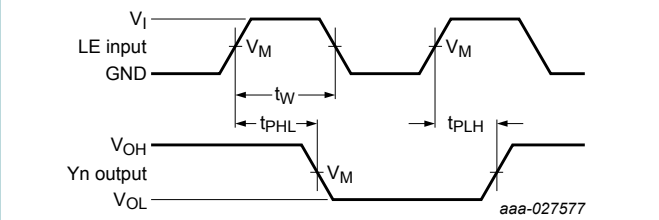

Measurement points are given in [Table 8](#). V_{OL} and V_{OH} are typical voltage output levels that occur with the output load.

Figure 6. LE input pulse width, LE input to Yn output propagation delays

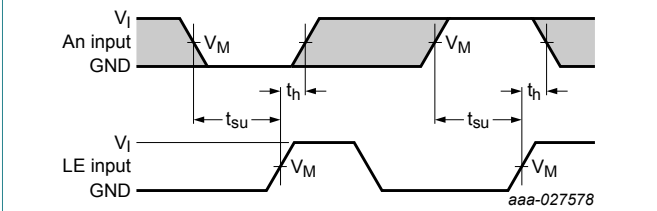

Measurement points are given in [Table 8](#). V_{OL} and V_{OH} are typical voltage output levels that occur with the output load. The shaded areas indicate when the input is permitted to change for predictable output performance.

Figure 7. Data set-up and hold times, An input to LE input

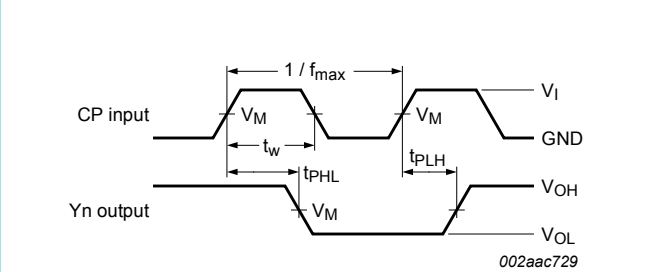

Measurement points are given in [Table 8](#). V_{OL} and V_{OH} are typical voltage output levels that occur with the output load.

Figure 8. CP to Yn propagation delays, clock pulse width, and maximum clock frequency

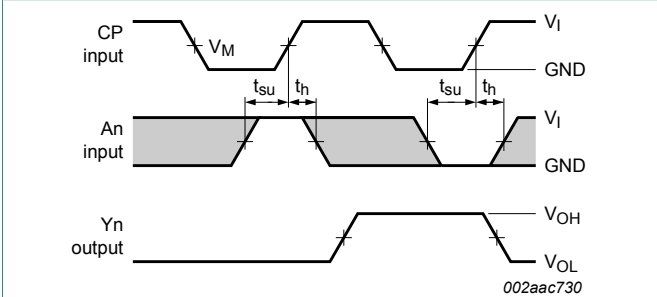

Measurement points are given in [Table 8](#). V_{OL} and V_{OH} are typical voltage output levels that occur with the output load. The shaded areas indicate when the input is permitted to change for predictable output performance.

Figure 9. Data set-up and hold times, An input to CP input

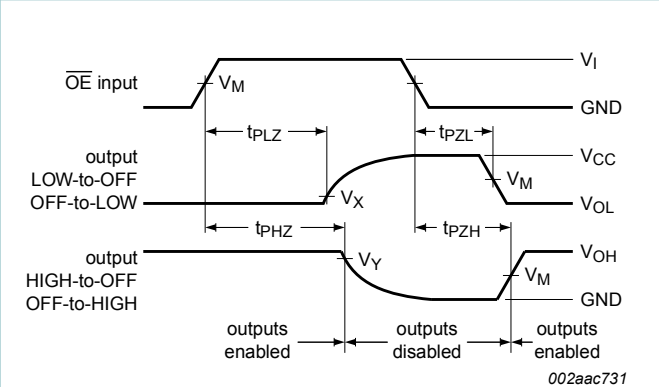

Measurement points are given in [Table 8](#). V_{OL} and V_{OH} are typical voltage output levels that occur with the output load.

Figure 10. 3-state enable and disable times

Table 8. Measurement points

Supply voltage	Input		Output		
V _{CC}	V _I	V _M	V _M	V _X	V _Y
≤ 2.3 V	V _{CC}	0.5 × V _{CC}	0.5 × V _{CC}	V _{OL} + 0.15 V	V _{OH} - 0.15 V
2.3 V to 2.7 V	V _{CC}	0.5 × V _{CC}	0.5 × V _{CC}	V _{OL} + 0.15 V	V _{OH} - 0.15 V
2.7 V	2.7 V	1.5 V	1.5 V	V _{OL} + 0.3 V	V _{OH} - 0.3 V
3.0 V to 3.6 V	2.7 V	1.5 V	1.5 V	V _{OL} + 0.3 V	V _{OH} - 0.3 V

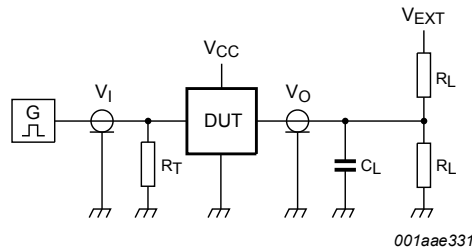
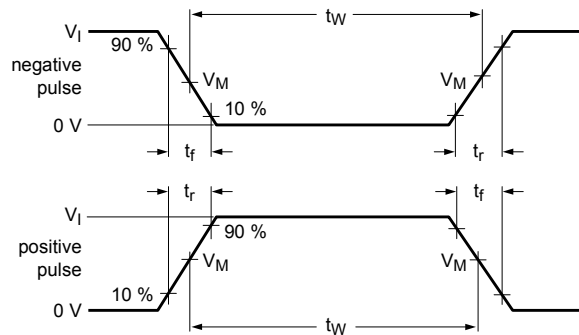

001aae331

Test data is given in [Table 9](#).

Definitions for test circuit:

R_L = Load resistance.

C_L = Load capacitance including jig and probe capacitance.

R_T = Termination resistance should be equal to output impedance Z_o of the pulse generator.

V_{EXT} = External voltage for measuring switching times.

Figure 11. Test circuit for measuring switching times

Table 9. Test data

Supply voltage	Input		Load		V _{EXT}		
V _{CC}	V _I	t _r , t _f	C _L	R _L	t _{PLH} , t _{PHL}	t _{PLZ} , t _{PZL}	t _{PHZ} , t _{PZH}
≤ 2.3 V	V _{CC}	≤ 2.0 ns	30 pF	500 Ω	open	2 × V _{CC}	GND
2.3 V to 2.7 V	V _{CC}	≤ 2.0 ns	30 pF	500 Ω	open	2 × V _{CC}	GND
2.7 V	2.7 V	≤ 2.5 ns	50 pF	500 Ω	open	2 × V _{CC}	GND
3.0 V to 3.6 V	2.7 V	≤ 2.5 ns	50 pF	500 Ω	open	2 × V _{CC}	GND

11 Package outline

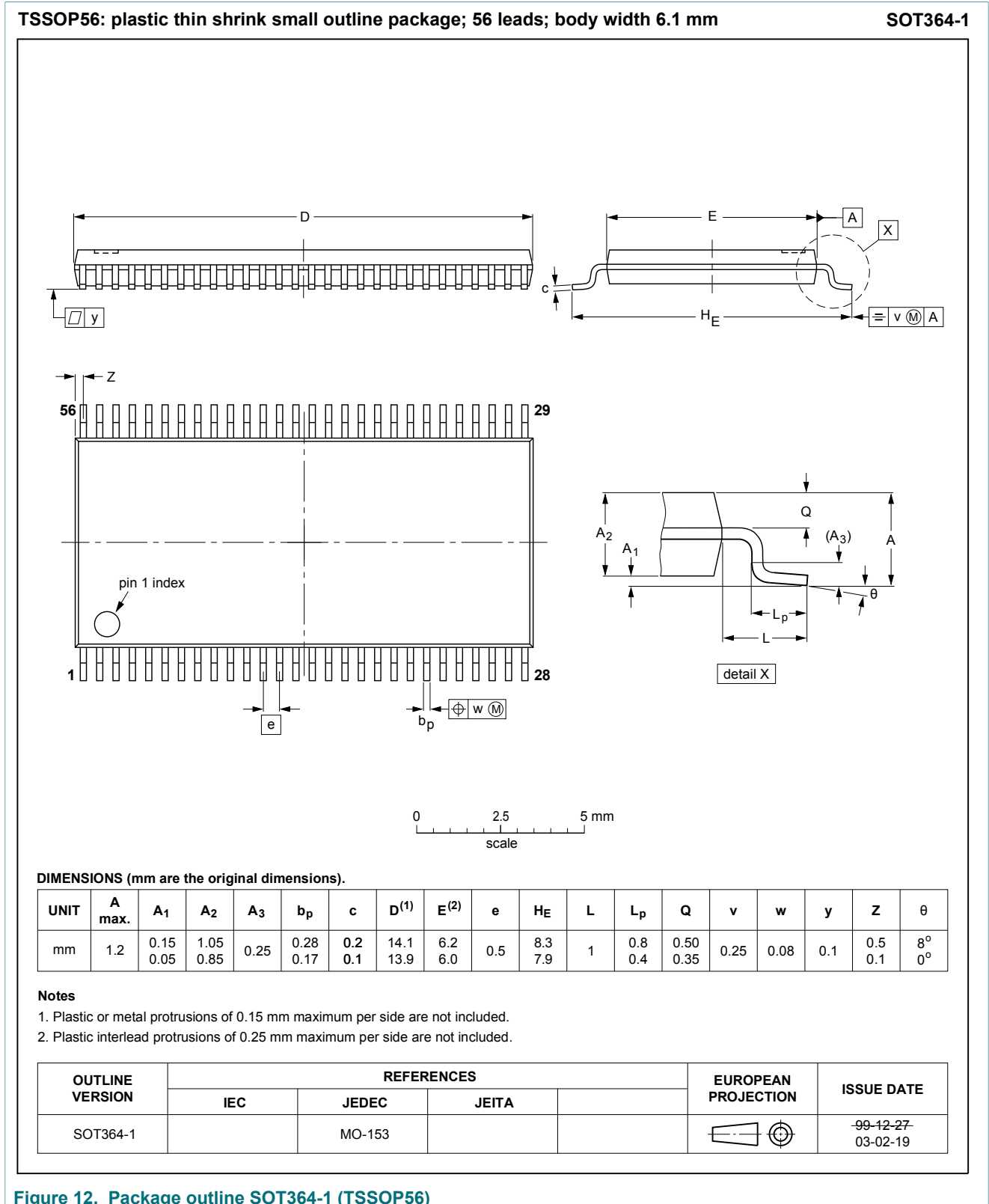

Figure 12. Package outline SOT364-1 (TSSOP56)

12 Abbreviations

Table 10. Abbreviations

Acronym	Description
CMOS	Complementary Metal-Oxide Semiconductor
DUT	Device Under Test
TTL	Transistor-Transistor Logic

13 Revision history

Table 11. Revision history

Document ID	Release date	Data sheet status	Change notice	Supersedes
74ALVC162835A v.7	20171012	Product data sheet	-	74ALVC162835A v.6
Modifications:	<ul style="list-style-type: none"> The format of this data sheet has been redesigned to comply with the identity guidelines of Nexperia. Legal texts have been adapted to the new company name where appropriate. 			
74ALVC162835A v.6	20000620	Product specification	-	74ALVC162835A v.5
74ALVC162835A v.5	20000314	Product specification	-	-

14 Legal information

14.1 Data sheet status

Document status ^{[1][2]}	Product status ^[3]	Definition
Objective [short] data sheet	Development	This document contains data from the objective specification for product development.
Preliminary [short] data sheet	Qualification	This document contains data from the preliminary specification.
Product [short] data sheet	Production	This document contains the product specification.

[1] Please consult the most recently issued document before initiating or completing a design.

[2] The term 'short data sheet' is explained in section "Definitions".

[3] The product status of device(s) described in this document may have changed since this document was published and may differ in case of multiple devices. The latest product status information is available on the Internet at URL <http://www.nexperia.com>.

14.2 Definitions

Draft — The document is a draft version only. The content is still under internal review and subject to formal approval, which may result in modifications or additions. Nexperia does not give any representations or warranties as to the accuracy or completeness of information included herein and shall have no liability for the consequences of use of such information.

Short data sheet — A short data sheet is an extract from a full data sheet with the same product type number(s) and title. A short data sheet is intended for quick reference only and should not be relied upon to contain detailed and full information. For detailed and full information see the relevant full data sheet, which is available on request via the local Nexperia sales office. In case of any inconsistency or conflict with the short data sheet, the full data sheet shall prevail.

Product specification — The information and data provided in a Product data sheet shall define the specification of the product as agreed between Nexperia and its customer, unless Nexperia and customer have explicitly agreed otherwise in writing. In no event however, shall an agreement be valid in which the Nexperia product is deemed to offer functions and qualities beyond those described in the Product data sheet.

14.3 Disclaimers

Limited warranty and liability — Information in this document is believed to be accurate and reliable. However, Nexperia does not give any representations or warranties, expressed or implied, as to the accuracy or completeness of such information and shall have no liability for the consequences of use of such information. Nexperia takes no responsibility for the content in this document if provided by an information source outside of Nexperia. In no event shall Nexperia be liable for any indirect, incidental, punitive, special or consequential damages (including - without limitation - lost profits, lost savings, business interruption, costs related to the removal or replacement of any products or rework charges) whether or not such damages are based on tort (including negligence), warranty, breach of contract or any other legal theory. Notwithstanding any damages that customer might incur for any reason whatsoever, Nexperia's aggregate and cumulative liability towards customer for the products described herein shall be limited in accordance with the Terms and conditions of commercial sale of Nexperia.

Right to make changes — Nexperia reserves the right to make changes to information published in this document, including without limitation specifications and product descriptions, at any time and without notice. This document supersedes and replaces all information supplied prior to the publication hereof.

Suitability for use — Nexperia products are not designed, authorized or warranted to be suitable for use in life support, life-critical or safety-critical

systems or equipment, nor in applications where failure or malfunction of an Nexperia product can reasonably be expected to result in personal injury, death or severe property or environmental damage. Nexperia and its suppliers accept no liability for inclusion and/or use of Nexperia products in such equipment or applications and therefore such inclusion and/or use is at the customer's own risk.

Applications — Applications that are described herein for any of these products are for illustrative purposes only. Nexperia makes no representation or warranty that such applications will be suitable for the specified use without further testing or modification. Customers are responsible for the design and operation of their applications and products using Nexperia products, and Nexperia accepts no liability for any assistance with applications or customer product design. It is customer's sole responsibility to determine whether the Nexperia product is suitable and fit for the customer's applications and products planned, as well as for the planned application and use of customer's third party customer(s). Customers should provide appropriate design and operating safeguards to minimize the risks associated with their applications and products. Nexperia does not accept any liability related to any default, damage, costs or problem which is based on any weakness or default in the customer's applications or products, or the application or use by customer's third party customer(s). Customer is responsible for doing all necessary testing for the customer's applications and products using Nexperia products in order to avoid a default of the applications and the products or of the application or use by customer's third party customer(s). Nexperia does not accept any liability in this respect.

Limiting values — Stress above one or more limiting values (as defined in the Absolute Maximum Ratings System of IEC 60134) will cause permanent damage to the device. Limiting values are stress ratings only and (proper) operation of the device at these or any other conditions above those given in the Recommended operating conditions section (if present) or the Characteristics sections of this document is not warranted. Constant or repeated exposure to limiting values will permanently and irreversibly affect the quality and reliability of the device.

Terms and conditions of commercial sale — Nexperia products are sold subject to the general terms and conditions of commercial sale, as published at <http://www.nexperia.com/profile/terms>, unless otherwise agreed in a valid written individual agreement. In case an individual agreement is concluded only the terms and conditions of the respective agreement shall apply. Nexperia hereby expressly objects to applying the customer's general terms and conditions with regard to the purchase of Nexperia products by customer.

No offer to sell or license — Nothing in this document may be interpreted or construed as an offer to sell products that is open for acceptance or the grant, conveyance or implication of any license under any copyrights, patents or other industrial or intellectual property rights.

Export control — This document as well as the item(s) described herein may be subject to export control regulations. Export might require a prior authorization from competent authorities.

Non-automotive qualified products — Unless this data sheet expressly states that this specific Nexperia product is automotive qualified, the product is not suitable for automotive use. It is neither qualified nor tested in accordance with automotive testing or application requirements. Nexperia accepts no liability for inclusion and/or use of non-automotive qualified products in automotive equipment or applications. In the event that customer uses the product for design-in and use in automotive applications to automotive specifications and standards, customer (a) shall use the product without Nexperia's warranty of the product for such automotive applications, use and specifications, and (b) whenever customer uses the product for automotive applications beyond Nexperia's specifications such use shall be solely at customer's own risk, and (c) customer fully indemnifies Nexperia for any liability, damages or failed product claims resulting from customer

design and use of the product for automotive applications beyond Nexperia's standard warranty and Nexperia's product specifications.

Translations — A non-English (translated) version of a document is for reference only. The English version shall prevail in case of any discrepancy between the translated and English versions.

14.4 Trademarks

Notice: All referenced brands, product names, service names and trademarks are the property of their respective owners.

Contents

1	General description	1
2	Features and benefits	1
3	Ordering information	1
4	Functional diagram	2
5	Pinning information	3
5.1	Pinning	3
5.2	Pin description	4
6	Functional description	4
7	Limiting values	5
8	Recommended operating conditions	5
9	Static characteristics	6
10	Dynamic characteristics	7
10.1	Waveforms and test circuit	9
11	Package outline	11
12	Abbreviations	12
13	Revision history	12
14	Legal information	13

Please be aware that important notices concerning this document and the product(s) described herein, have been included in section 'Legal information'.

© Nexperia B.V. 2017.

All rights reserved.



For more information, please visit: <http://www.nexperia.com>

For sales office addresses, please send an email to: salesaddresses@nexperia.com

Date of release: 12 October 2017
Document identifier: 74ALVC162835A

Looking for pricing, stock, or lifecycle information?

Click below to explore more details on WIN SOURCE:

-  [View 74ALVC162835ADGG:1 on WIN SOURCE](#)
-  [NXP / Nexperia Information](#)

Optimize Your Supply Chain with WIN SOURCE Solutions

-  Global Sourcing Solution
-  Obsolete Management
-  Cost Control Management
-  Shortage Management
-  Alternative Solution
-  Excess Inventory Management