



**THE DATASHEET OF
SI8902EDB-T2-E1**



Bi-Directional N-Channel 20 V (D-S) MOSFET

PRODUCT SUMMARY		
V _{S1S2} (V)	R _{S1S2(on)} (Ω)	I _{S1S2} (A)
20	0.045 at V _{GS} = 4.5 V	5.0
	0.048 at V _{GS} = 3.7 V	4.8
	0.057 at V _{GS} = 2.5 V	4.4
	0.072 at V _{GS} = 1.8 V	3.9

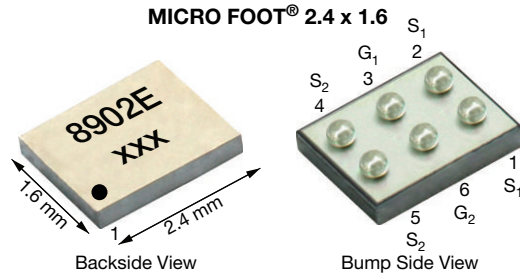

Marking Code: xxxx = 8902E

Ordering Information:

Si8902EDB-T2-E1 (Lead (Pb)-free and halogen-free)

FEATURES

- TrenchFET® power MOSFET
- Ultra-low R_{SS(on)}
- ESD protected: 4000 V
- MICRO FOOT® chipscale packaging reduces footprint area profile (0.62 mm) and on-resistance per footprint area
- Material categorization: for definitions of compliance please see www.vishay.com/doc?99912



RoHS
COMPLIANT
HALOGEN
FREE

APPLICATIONS

- Battery protection circuit
- 1-2 cell Li+/LiP battery pack for portable devices

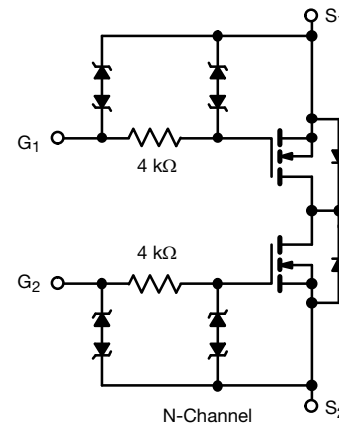

ABSOLUTE MAXIMUM RATINGS (T _A = 25 °C, unless otherwise noted)				
PARAMETER	SYMBOL	5 s	STEADYSTATE	UNIT
Source1- Source2 Voltage	V _{S1S2}	20		V
Gate-Source Voltage	V _{GS}	± 12		
Continuous Source1- Source2 Current (T _J = 150 °C) ^a	I _{S1S2}	T _A = 25 °C	5	A
		T _A = 85 °C	3.4	
Pulsed Source1- Source2 Current	I _{SM}	40		
Maximum Power Dissipation ^a	P _D	T _A = 25 °C	1.7	W
		T _A = 85 °C	0.8	
Operating Junction and Storage Temperature Range	T _J , T _{stg}	-55 to +150		°C
Package Reflow Conditions ^c	IR/Convection	260		

THERMAL RESISTANCE RATINGS					
PARAMETER		SYMBOL	TYPICAL	MAXIMUM	UNIT
Maximum Junction-to-Ambient ^a	t ≤ 5 s	R _{thJA}	60	75	°C/W
	Steady State		95	120	
Maximum Junction-to-Foot ^b	Steady State	R _{thJF}	18	22	

Notes

- Surface mounted on 1" x 1" FR4 board.
- The foot is defined as the top surface of the package.
- Refer to IPC/JEDEC® (J-STD-020), no manual or hand soldering.



SPECIFICATIONS (T _J = 25 °C, unless otherwise noted)						
PARAMETER	SYMBOL	TEST CONDITIONS	MIN.	TYP.	MAX.	UNIT
Static						
Gate Threshold Voltage	V _{GS(th)}	V _{SS} = V _{GS} , I _D = 980 μA	0.45	-	1	V
Gate-Body Leakage	I _{GSS}	V _{SS} = 0 V, V _{GS} = ± 4.5 V	-	-	± 4	μA
		V _{SS} = 0 V, V _{GS} = ± 12 V	-	-	± 10	mA
Zero Gate Voltage Source Current	I _{S1S2}	V _{SS} = 20 V, V _{GS} = 0 V	-	-	1	μA
		V _{SS} = 20 V, V _{GS} = 0 V, T _J = 85 °C	-	-	5	
On-State Source Current ^a	I _{S(on)}	V _{SS} = 5 V, V _{GS} = 4.5 V	5	-	-	A
Source1-Source2 On State Resistance ^a	R _{S1S2(on)}	V _{GS} = 4.5 V, I _{SS} = 1 A	-	0.038	0.045	Ω
		V _{GS} = 3.7 V, I _{SS} = 1 A	-	0.041	0.048	
		V _{GS} = 2.5 V, I _{SS} = 1 A	-	0.048	0.057	
		V _{GS} = 1.8 V, I _{SS} = 1 A	-	0.060	0.072	
Forward Transconductance ^a	g _{fs}	V _{SS} = 10 V, I _{SS} = 1 A	-	20	-	S
Dynamic ^b						
Turn-On Delay Time	t _{d(on)}	V _{SS} = 10 V, R _L = 10 Ω I _{SS} = 1 A, V _{GEN} = 4.5 V, R _g = 6 Ω	-	1	1.5	μs
Rise Time	t _r		-	3	4.5	
Turn-Off Delay Time	t _{d(off)}		-	17	26	
Fall Time	t _f		-	10	15	

Notes

- a. Pulse test; pulse width ≤ 300 μs, duty cycle ≤ 2 %.
- b. Guaranteed by design, not subject to production testing.

Stresses beyond those listed under "Absolute Maximum Ratings" may cause permanent damage to the device. These are stress ratings only, and functional operation of the device at these or any other conditions beyond those indicated in the operational sections of the specifications is not implied. Exposure to absolute maximum rating conditions for extended periods may affect device reliability.

TYPICAL CHARACTERISTICS (25 °C, unless otherwise noted)

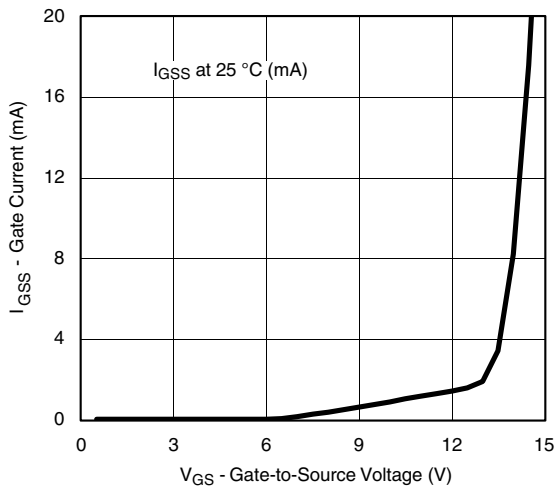

Gate-Current vs. Gate-Source Voltage

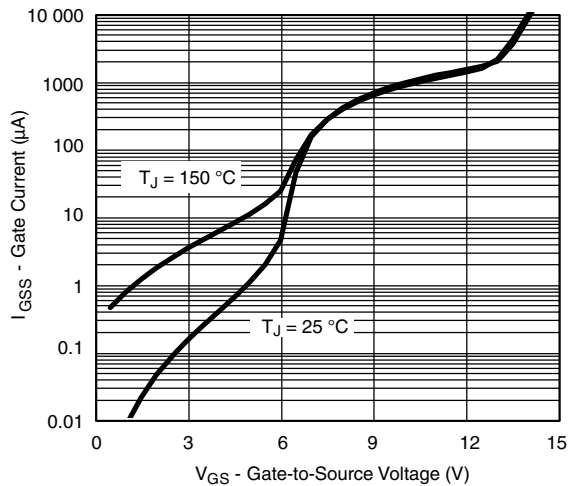

Gate Current vs. Gate-Source Voltage



TYPICAL CHARACTERISTICS (25 °C, unless otherwise noted)

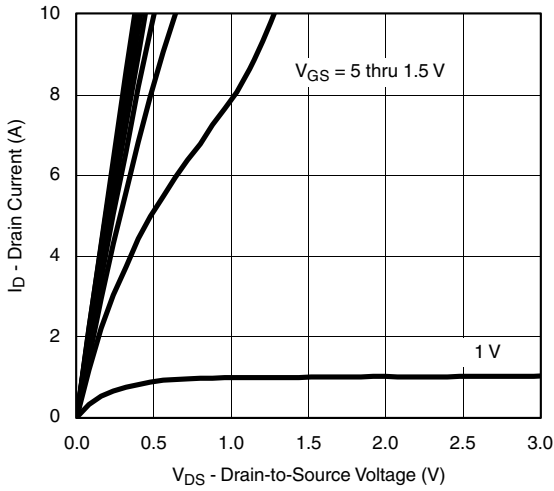

Output Characteristics

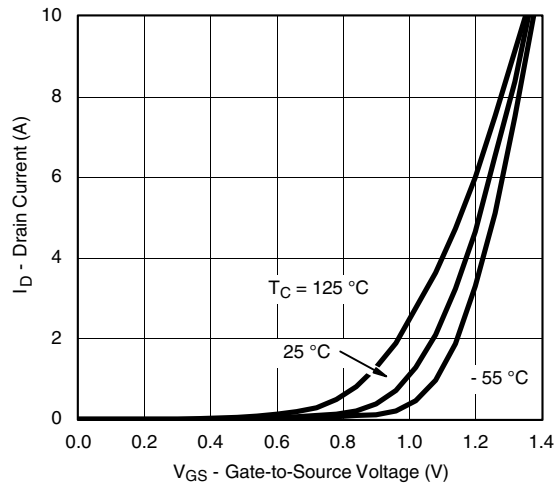

Transfer Characteristics

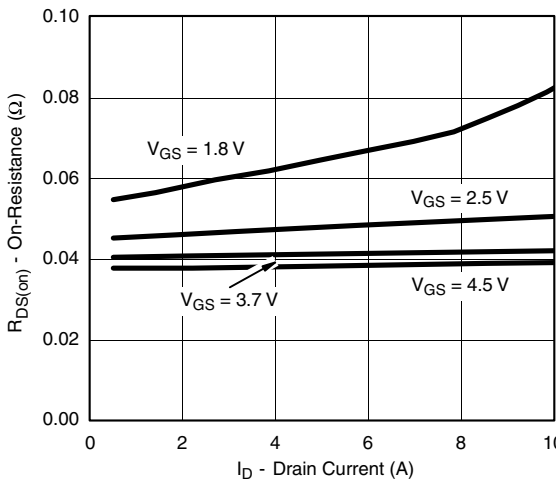

On-Resistance vs. Drain Current

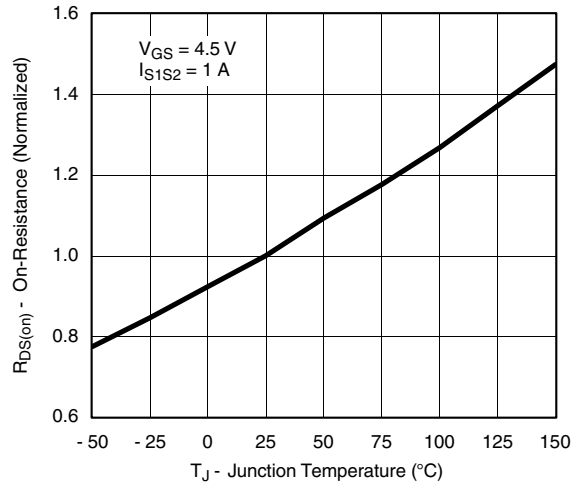

On-Resistance vs. Junction Temperature

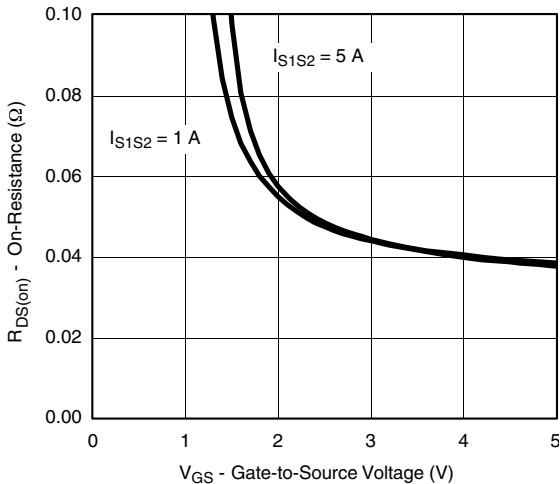

On-Resistance vs. Gate-to-Source Voltage

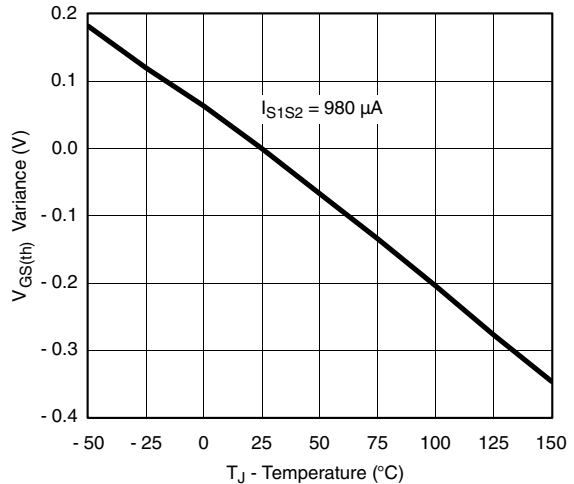

Threshold Voltage



TYPICAL CHARACTERISTICS (25 °C, unless otherwise noted)

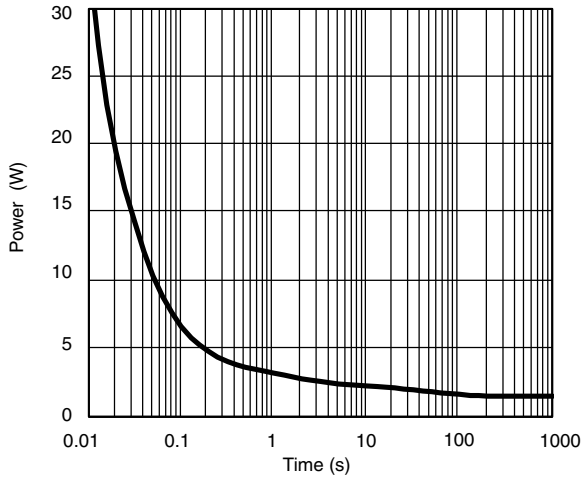

Single Pulse Power, Junction-to-Ambient

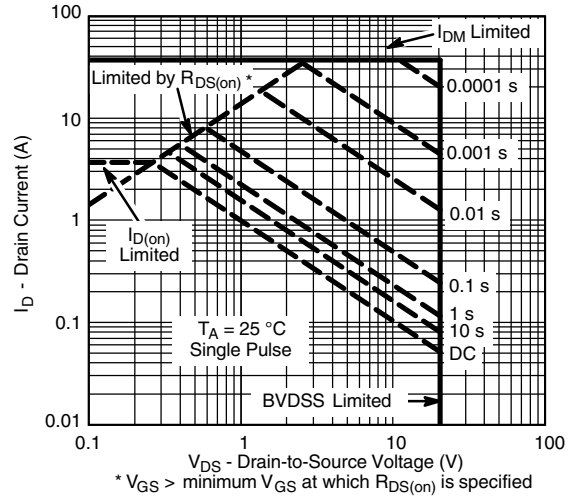

Safe Operating Area

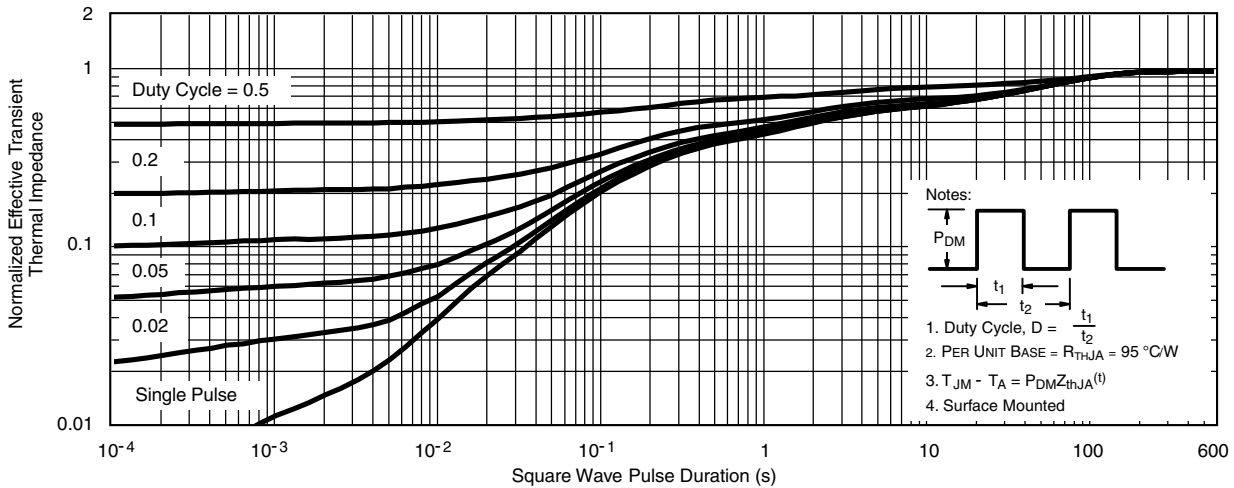

Normalized Thermal Transient Impedance, Junction-to-Ambient



TYPICAL CHARACTERISTICS (25 °C, unless otherwise noted)

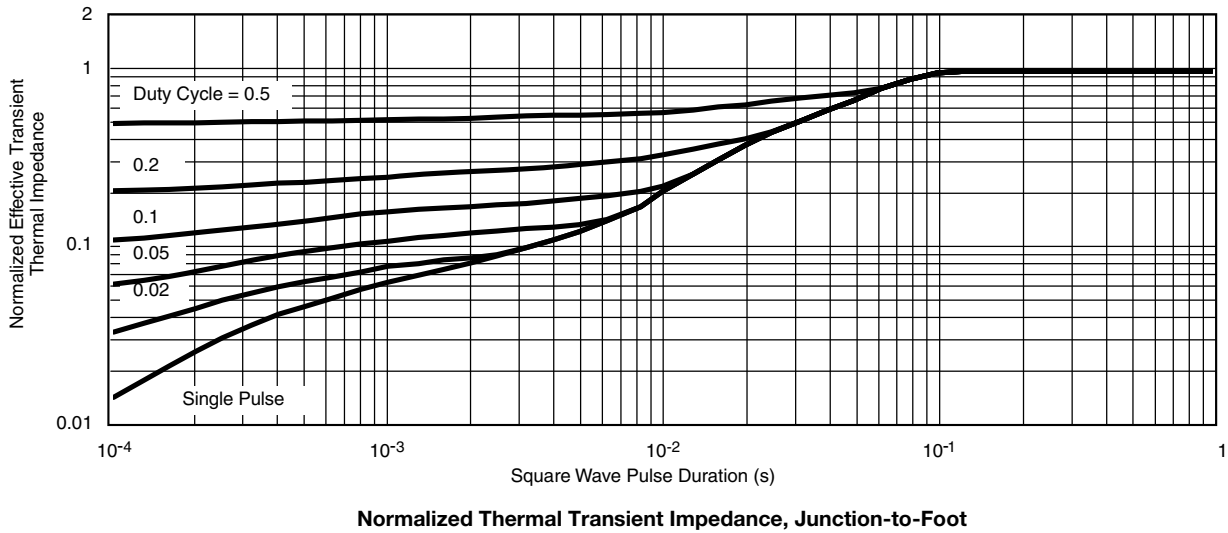

Vishay Siliconix maintains worldwide manufacturing capability. Products may be manufactured at one of several qualified locations. Reliability data for Silicon Technology and Package Reliability represent a composite of all qualified locations. For related documents such as package/tape drawings, part marking, and reliability data, see www.vishay.com/ppg?71862.



MICRO FOOT[®]: 6-Bumps (1.6 mm x 2.4 mm, 0.8 mm Pitch, 0.290 mm Bump Height)

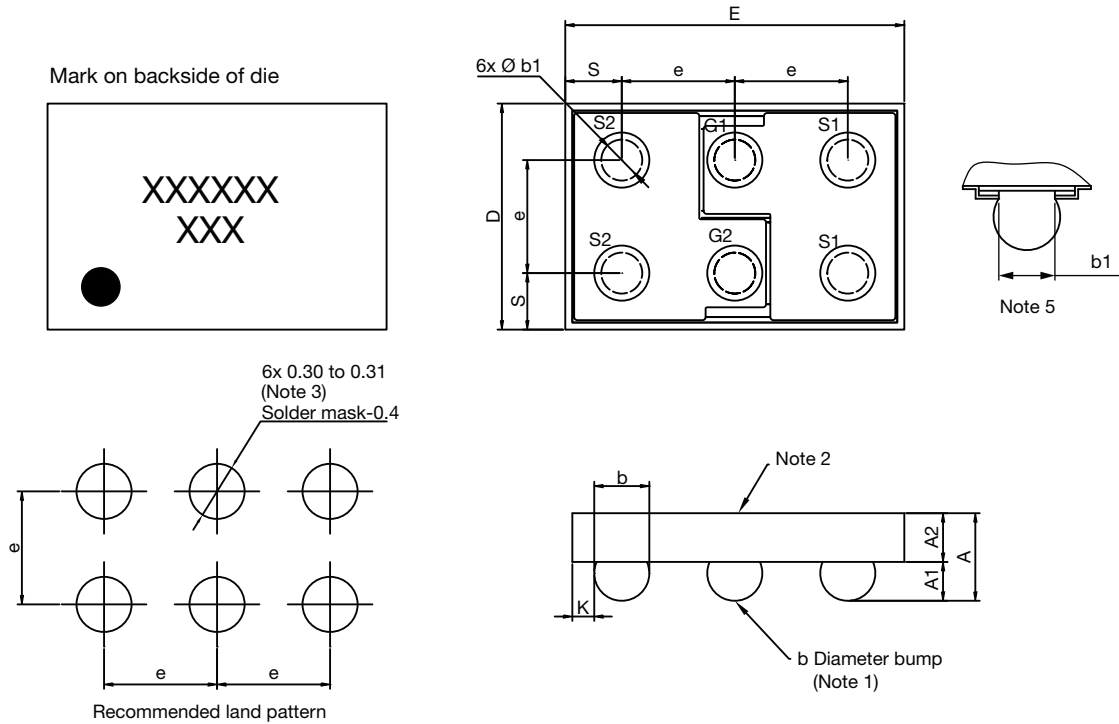

Notes

1. Bumps are 95.5/3.8/0.7 Sn/Ag/Cu.
2. Backside surface is coated with a Ti/Ni/Ag layer.
3. Non-solder mask defined copper landing pad.
4. Laser marks on the silicon die back.
5. "b1" is the diameter of the solderable substrate surface, defined by an opening in the solder resist layer solder mask defined.
6. • is the location of pin 1

DIM.	MILLIMETERS			INCHES		
	MIN.	NOM.	MAX.	MIN.	NOM.	MAX.
A	0.550	0.575	0.600	0.0217	0.0226	0.0236
A1	0.260	0.275	0.290	0.0102	0.0108	0.0114
A2	0.290	0.300	0.310	0.0114	0.0118	0.0122
b	0.370	0.390	0.410	0.0146	0.0153	0.0161
b1	0.300			0.0118		
e	0.800			0.0314		
s	0.360	0.380	0.400	0.0141	0.0150	0.0157
D	1.520	1.560	1.600	0.0598	0.0614	0.0630
E	2.320	2.360	2.400	0.0913	0.0929	0.0945
K	0.155	0.185	0.215	0.0061	0.0072	0.0084

Note

- Use millimeters as the primary measurement.

ECN: T15-0143-Rev. A, 27-Apr-15
DWG: 6036

PCB Design and Assembly Guidelines For MICRO FOOT® Products

Johnson Zhao

INTRODUCTION

Vishay Siliconix's MICRO FOOT product family is based on a wafer-level chip-scale packaging (WL-CSP) technology that implements a solder bump process to eliminate the need for an outer package to encase the silicon die. MICRO FOOT products include power MOSFETs, analog switches, and power ICs.

For battery powered compact devices, this new packaging technology reduces board space requirements, improves thermal performance, and mitigates the parasitic effect typical of leaded packaged products. For example, the 6-bump MICRO FOOT Si8902EDB common drain power MOSFET, which measures just 1.6 mm x 2.4 mm, achieves the same performance as TSSOP-8 devices in a footprint that is 80% smaller and with a 50% lower height profile (Figure 1). A MICRO FOOT analog switch, the 6-bump DG3000DB, offers low charge injection and 1.4 W on-resistance in a footprint measuring just 1.08 mm x 1.58 mm (Figure 2).

Vishay Siliconix MICRO FOOT products can be handled with the same process techniques used for high-volume assembly of packaged surface-mount devices. With proper attention to PCB and stencil design, the device will achieve reliable performance without underfill. The advantage of the device's small footprint and short thermal path make it an ideal option for space-constrained applications in portable devices such as battery packs, PDAs, cellular phones, and notebook computers.

This application note discusses the mechanical design and reliability of MICRO FOOT, and then provides guidelines for board layout, the assembly process, and the PCB rework process.

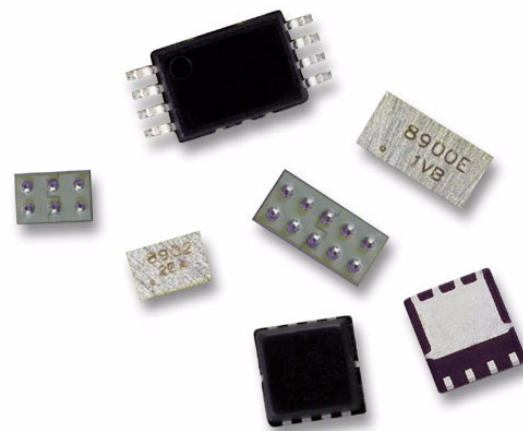

FIGURE 1. 3D View of MICRO FOOT Products Si8902DB and Si8900EDB

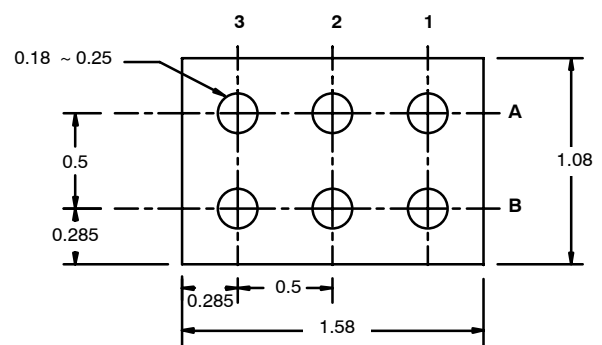

FIGURE 2. Outline of MICRO FOOT CSP & Analog Switch DG3000DB

TABLE 1 Main Parameters of Solder Bumps in MICRO FOOT Designs				
MICRO FOOT CSP	Bump Material	Bump Pitch*	Bump Diameter*	Bump Height*
MICRO FOOT CSP MOSFET	Eutectic Solder: 63Sm/37Pb	0.8	0.37-0.41	0.26-0.29
MICRO FOOT CSP Analog Switch		0.5	0.18-0.25	0.14-0.19
MICRO FOOT UCSP Analog Switch		0.5	0.32-0.34	0.21-0.24

* All measurements in millimeters

MICRO FOOT'S DESIGN AND RELIABILITY

As a mechanical, electrical, and thermal connection between the device and PCB, the solder bumps of MICRO FOOT products are mounted on the top active surface of the die. Table 1 shows the main parameters for solder bumps used in MICRO FOOT products. A silicon nitride passivation layer is applied to the active area as the last masking process in fabrication, ensuring that the device passes the pressure pot test. A green laser is used to mark the backside of the die without damaging it. Reliability results for MICRO FOOT products mounted on a FR-4 board without underfill are shown in Table 2.

TABLE 2 MICRO FOOT Reliability Results	
Test Condition C: -65° to 150°C	>500 Cycles
Test condition B: -40° to 125°C	>1000 Cycles
121°C @ 15PSI 100% Humidity Test	96 Hours

The main failure mechanism associated with wafer-level chip-scale packaging is fatigue of the solder joint. The results shown in Table 2 demonstrate that a high level of reliability can be achieved with proper board design and assembly techniques.

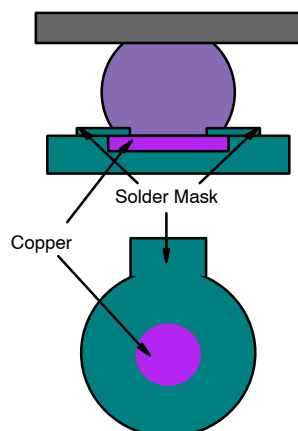

FIGURE 3. SMD

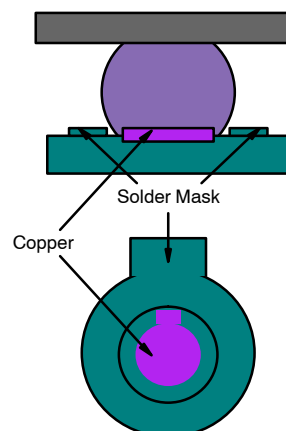

FIGURE 4. NSMD

BOARD LAYOUT GUIDELINES

Board materials. Vishay Siliconix MICRO FOOT products are designed to be reliable on most board types, including organic boards such as FR-4 or polyamide boards. The package qualification information is based on the test on 0.5-oz. FR-4 and polyamide boards with NSMD pad design.

Land patterns. Two types of land patterns are used for surface-mount packages. Solder mask defined (SMD) pads have a solder mask opening smaller than the metal pad (Figure 3), whereas on-solder mask defined (NSMD) pads have a metal pad smaller than the solder-mask opening (Figure 4).

NSMD is recommended for copper etch processes, since it provides a higher level of control compared to SMD etch processes. A small-size NSMD pad definition provides more area (both lateral and vertical) for soldering and more room for escape routing on the PCB. By contrast, SMD pad definition introduces a stress-concentration point near the solder mask on the PCB side that may result in solder joint cracking under extreme fatigue conditions.

Copper pads should be finished with an organic solderability preservative (OSP) coating. For electroplated nickel-immersion gold finish pads, the gold thickness must be less than 0.5 μm to avoid solder joint embrittlement.

Board pad design. The landing-pad size for MICRO FOOT products is determined by the bump pitch as shown in Table 3. The pad pattern is circular to ensure a symmetric, barrel-shaped solder bump.

TABLE 3 Dimensions of Copper Pad and Solder Mask Opening in PCB and Stencil Aperture			
Pitch	Copper Pad	Solder Mask Opening	Stencil Aperture
0.80 mm	0.30 ± 0.01 mm	0.41 ± 0.01 mm	0.33 ± 0.01 mm in circle aperture
0.50 mm	0.17 ± 0.01 mm	0.27 ± 0.01 mm	0.30 ± 0.01 mm in square aperture

ASSEMBLY PROCESS

MICRO FOOT products' surface-mount-assembly operations include solder paste printing, component placement, and solder reflow as shown in the process flow chart (Figure 5).

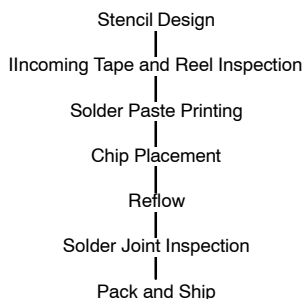

FIGURE 5. SMT Assembly Process Flow

Stencil design. Stencil design is the key to ensuring maximum solder paste deposition without compromising the assembly yield from solder joint defects (such as bridging and extraneous solder spheres). The stencil aperture is dependent on the copper pad size, the solder mask opening, and the quantity of solder paste.

In MICRO FOOT products, the stencil is 0.125-mm (5-mils) thick. The recommended apertures are shown in Table 3 and are fabricated by laser cut.

Solder-paste printing. The solder-paste printing process involves transferring solder paste through pre-defined apertures via application of pressure.

In MICRO FOOT products, the solder paste used is UP78 No-clean eutectic 63 Sn/37Pb type3 or finer solder paste.

Chip pick-and-placement. MICRO FOOT products can be picked and placed with standard pick-and-place equipment. The recommended pick-and-place force is 150 g. Though the part will self-center during solder reflow, the maximum placement offset is 0.02 mm.

Reflow Process. MICRO FOOT products can be assembled using standard SMT reflow processes. Similar to any other package, the thermal profile at specific board locations must be determined. Nitrogen purge is recommended during reflow operation. Figure 6 shows a typical reflow profile.

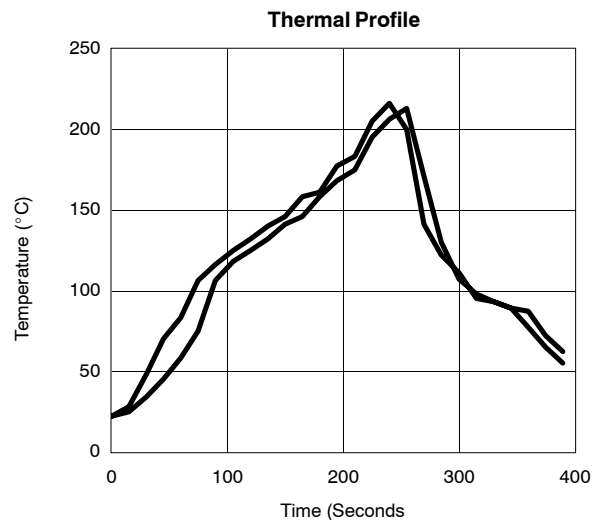

FIGURE 6. Reflow Profile

PCB REWORK

To replace MICRO FOOT products on PCB, the rework procedure is much like the rework process for a standard BGA or CSP, as long as the rework process duplicates the original reflow profile. The key steps are as follows:

1. Remove the MICRO FOOT device using a convection nozzle to create localized heating similar to the original reflow profile. Preheat from the bottom.
2. Once the nozzle temperature is +190°C, use tweezers to remove the part to be replaced.
3. Resurface the pads using a temperature-controlled soldering iron.
4. Apply gel flux to the pad.
5. Use a vacuum needle pick-up tip to pick up the replacement part, and use a placement jig to place it accurately.
6. Reflow the part using the same convection nozzle, and preheat from the bottom, matching the original reflow profile.



Disclaimer

ALL PRODUCT, PRODUCT SPECIFICATIONS AND DATA ARE SUBJECT TO CHANGE WITHOUT NOTICE TO IMPROVE RELIABILITY, FUNCTION OR DESIGN OR OTHERWISE.

Vishay Intertechnology, Inc., its affiliates, agents, and employees, and all persons acting on its or their behalf (collectively, "Vishay"), disclaim any and all liability for any errors, inaccuracies or incompleteness contained in any datasheet or in any other disclosure relating to any product.

Vishay makes no warranty, representation or guarantee regarding the suitability of the products for any particular purpose or the continuing production of any product. To the maximum extent permitted by applicable law, Vishay disclaims (i) any and all liability arising out of the application or use of any product, (ii) any and all liability, including without limitation special, consequential or incidental damages, and (iii) any and all implied warranties, including warranties of fitness for particular purpose, non-infringement and merchantability.

Statements regarding the suitability of products for certain types of applications are based on Vishay's knowledge of typical requirements that are often placed on Vishay products in generic applications. Such statements are not binding statements about the suitability of products for a particular application. It is the customer's responsibility to validate that a particular product with the properties described in the product specification is suitable for use in a particular application. Parameters provided in datasheets and / or specifications may vary in different applications and performance may vary over time. All operating parameters, including typical parameters, must be validated for each customer application by the customer's technical experts. Product specifications do not expand or otherwise modify Vishay's terms and conditions of purchase, including but not limited to the warranty expressed therein.

Except as expressly indicated in writing, Vishay products are not designed for use in medical, life-saving, or life-sustaining applications or for any other application in which the failure of the Vishay product could result in personal injury or death. Customers using or selling Vishay products not expressly indicated for use in such applications do so at their own risk. Please contact authorized Vishay personnel to obtain written terms and conditions regarding products designed for such applications.

No license, express or implied, by estoppel or otherwise, to any intellectual property rights is granted by this document or by any conduct of Vishay. Product names and markings noted herein may be trademarks of their respective owners.

Looking for pricing, stock, or lifecycle information?

Click below to explore more details on WIN SOURCE:

 [View S18902EDB-T2-E1 on WIN SOURCE](#)

 [Vishay Information](#)

Optimize Your Supply Chain with WIN SOURCE Solutions

-  Global Sourcing Solution
-  Obsolete Management
-  Cost Control Management
-  Shortage Management
-  Alternative Solution
-  Excess Inventory Management