



**THE DATASHEET OF  
SMV1142-011**



DATA SHEET

# SMV114x Series: Hyperabrupt Junction Tuning Varactors

## Applications

- High volume commercial systems

## Features

- Frequency linear design
- Low series resistance
- Packages rated MSL1, 260 °C per JEDEC J-STD-020



Skyworks Green™ products are compliant with all applicable legislation and are halogen-free. For additional information, refer to *Skyworks Definition of Green™*, document number SQ04-0074.





## Description

The SMV114x series of silicon hyperabrupt junction varactor diodes is specifically designed with an increasing gamma versus voltage characteristic. This results in improved Voltage-Controlled Oscillator (VCO) frequency-voltage linearity compared to a conventional hyperabrupt junction varactor.

The SMV114x family of varactors is characterized for capacitance and resistance over temperature.

Table 1 describes the various packages and markings of the SMV114x varactors.

**Table 1. Packaging and Marking**

	
Single	Single
SC-79 Green™	SOD-323 Green™
	<b>SMV1142-011LF</b> Marking: GU
	<b>SMV-1143-011LF</b> Marking: GV
	<b>SMV-1144-011LF</b> Marking: GW
<b>SMV1145-079LF</b> Marking: Cathode	<b>SMV1145-011LF</b> Marking: GA
<b>SMV1147-079LF</b> Marking: Cathode	<b>SMV1147-011LF</b> Marking: GY
	<b>SMV1148-011LF</b> Marking: GZ
Ls = 0.7 nH	Ls = 1.5 nH



The Pb-free symbol or "LF" in the part number denotes a lead-free, RoHS-compliant package unless otherwise noted as Green™. Tin/lead (Sn/Pb) packaging is not recommended for new designs.

**Table 2. SMV114x Absolute Maximum Ratings**

Parameter	Symbol	Minimum	Typical	Maximum	Units
Reverse voltage	$V_R$			12	V
Forward current	$I_F$			20	mA
Power dissipation	$P_{DIS}$			250	mW
Operating temperature	$T_{OP}$	-55		+125	°C
Storage temperature	$T_{STG}$	-55		+150	°C

**Note:** Exposure to maximum rating conditions for extended periods may reduce device reliability. There is no damage to device with only one parameter set at the limit and all other parameters set at or below their nominal value. Exceeding any of the limits listed here may result in permanent damage to the device.

**CAUTION:** Although this device is designed to be as robust as possible, Electrostatic Discharge (ESD) can damage this device. This device must be protected at all times from ESD. Static charges may easily produce potentials of several kilovolts on the human body or equipment, which can discharge without detection. Industry-standard ESD precautions should be used at all times. The SMV114x varactors are Class 0 Human Body Model (HBM) ESD devices.

**Table 3. SMV114x Electrical Specifications (Note 1) (Note 2)**  
( $T_{OP} = 25\text{ °C}$ , Unless Otherwise Noted)

Part Number	$C_T @ 1\text{ V}$ (pF)		$C_T @ 3\text{ V}$ (pF)	$C_T @ 6\text{ V}$ (pF)	$\frac{C_T @ 1\text{ V}}{C_T @ 3\text{ V}}$ Ratio (pF)		$\frac{C_T @ 1\text{ V}}{C_T @ 6\text{ V}}$ Ratio (pF)		$R_S @ 3\text{ V},$ 500 MHz ( $\Omega$ )	$Q @ 3\text{ V},$ 50 MHz
	Min.	Max.	Typ.	Typ.	Min.	Max.	Min.	Max.	Max.	Typ.
SMV1142	8.20	10.0	5.80	3.50	1.50	1.65	2.43	2.93	0.70	800
SMV1143	11.60	14.2	8.20	4.90	1.50	1.65	2.45	2.95	0.65	600
SMV1144	14.65	17.95	10.4	6.10	1.50	1.65	2.46	2.96	0.65	500
SMV1145	25.50	31.2	18.1	10.6	1.50	1.65	2.50	3.00	0.60	300
SMV1147	54.60	66.7	38.6	22.6	1.50	1.65	2.50	3.00	0.55	150
SMV1148	62.00	76.0	44.1	25.2	1.50	1.65	2.50	3.00	0.50	150

**Note 1:** Performance is guaranteed only under the conditions listed in this Table.

**Note 2:** Reverse voltage,  $V_R$  ( $I_R = 10\ \mu\text{A}$ ): 12 V minimum.  
Reverse current,  $I_R$  ( $V_R = 9.6\text{ V}$ ): 20 nA maximum.

### Electrical and Mechanical Specifications

The absolute maximum ratings of the SMV114x varactors are provided in Table 2. Electrical specifications are provided in Table 3. Typical performance characteristics for the SMV114x varactors are illustrated in Figures 1 through 4. Table 4 summarizes the capacitance of the SMV114x series for reverse voltages between 0 and 12 V.

The SPICE model for the SMV114x varactor series is shown in Figure 5 and the associated model parameters are provided in Table 5.

Package dimensions are provided in Figures 6 and 8. Tape and reel dimensions are provided in Figures 7 and 9.

when the part is subjected to high temperature during solder assembly.

The SMV114x varactors are rated to Moisture Sensitivity Level 1 (MSL1) at 260 °C. They can be used for lead or lead-free soldering. For additional information, refer to the Skyworks Application Note, *Solder Reflow Information*, document number 200164.

Care must be taken when attaching this product, whether it is done manually or in a production solder reflow environment. Production quantities of this product are shipped in a standard tape and reel format.

### Package and Handling Information

Instructions on the shipping container label regarding exposure to moisture after the container seal is broken must be followed. Otherwise, problems related to moisture absorption may occur

### Typical Performance Characteristics

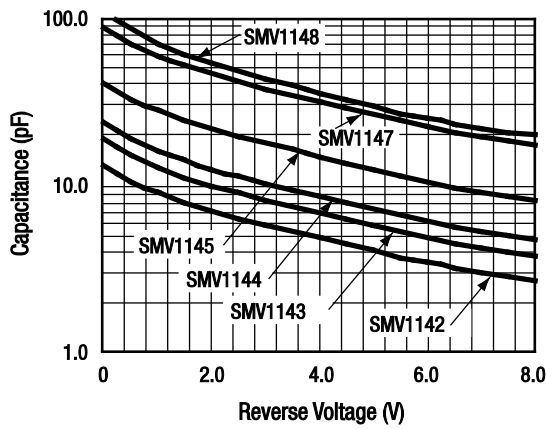

Figure 1. Capacitance vs Reverse Voltage

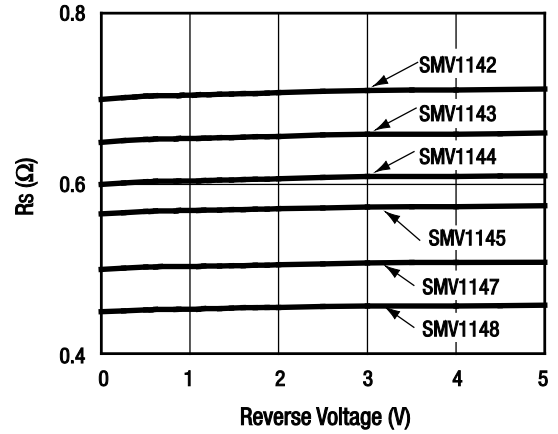

Figure 2. Series Resistance vs Reverse Voltage @ 500 MHz

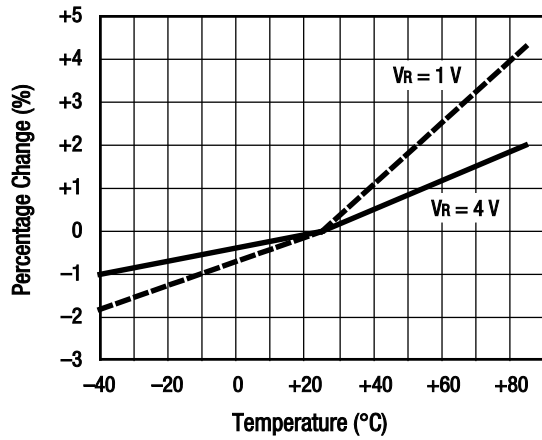

Figure 3. Relative Capacitance Change vs Temperature

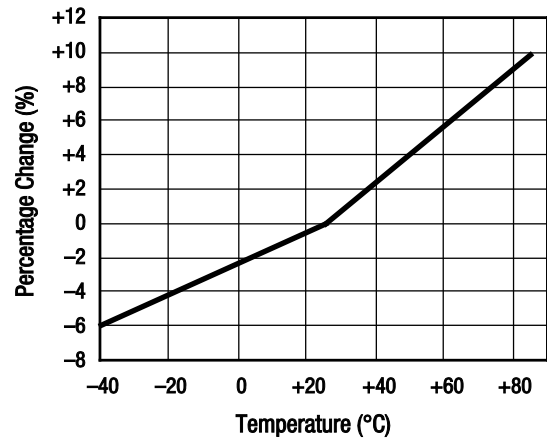

Figure 4. Relative Series Resistance Change vs Temperature

**Table 4. Capacitance vs Reverse Voltage**

V <sub>R</sub> (V)	C <sub>T</sub> (pF)					
	SMV1142	SMV1143	SMV1144	SMV1145	SMV1147	SMV1148
0	13.38	18.99	24.01	41.81	89.52	104.71
0.5	10.70	15.18	19.18	33.38	71.44	83.27
1.0	9.10	12.90	16.30	28.35	60.65	70.48
1.5	7.98	11.30	14.28	24.82	53.07	61.48
2.0	7.12	10.08	12.73	22.11	47.27	54.56
2.5	6.42	9.08	11.46	19.91	42.55	48.92
3.0	5.83	8.24	10.40	18.06	38.58	44.13
3.5	5.32	7.51	9.48	16.45	35.12	39.97
4.0	4.86	6.87	8.66	15.02	32.06	36.29
4.5	4.45	6.29	7.93	13.73	29.31	32.99
5.0	4.09	5.76	7.26	12.57	26.81	30.03
5.5	3.75	5.29	6.66	11.53	24.57	27.43
6.0	3.46	4.87	6.13	10.60	22.58	25.22
6.5	3.21	4.51	5.68	9.81	20.89	23.43
7.0	3.00	4.22	5.31	9.17	19.52	22.06
7.5	2.84	3.99	5.02	8.66	18.43	21.01
8.0	2.72	3.82	4.80	8.29	17.63	20.22
8.5	2.63	3.69	4.63	7.99	16.98	19.61
9.0	2.56	3.58	4.50	7.76	16.50	19.12
9.5	2.50	3.50	4.40	7.58	16.10	18.72
10.0	2.45	3.43	4.31	7.43	15.78	18.38
10.5	2.41	3.37	4.24	7.30	15.50	18.11
11.0	2.36	3.31	4.15	7.15	15.18	17.87
11.5	2.35	3.28	4.15	7.10	15.08	17.65
12.0	2.32	3.25	4.08	7.02	14.90	17.43

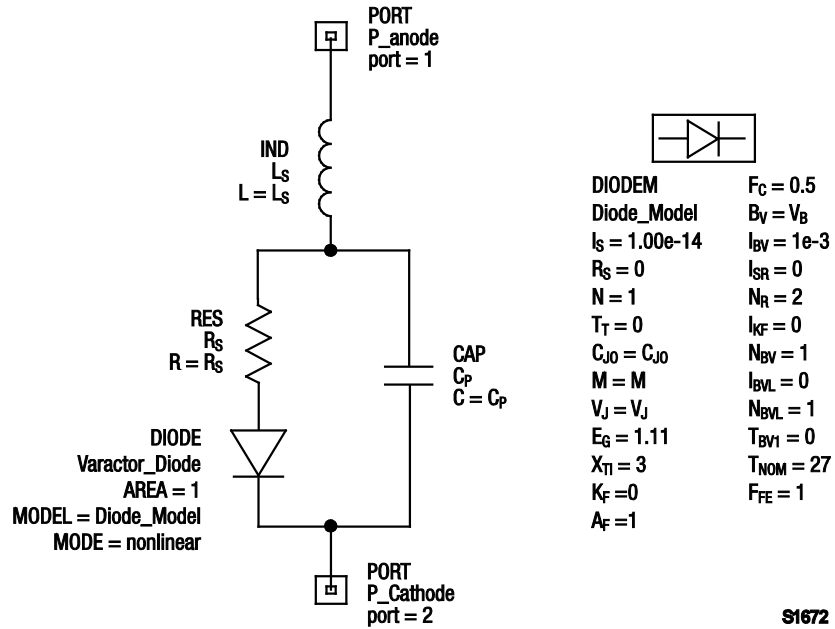
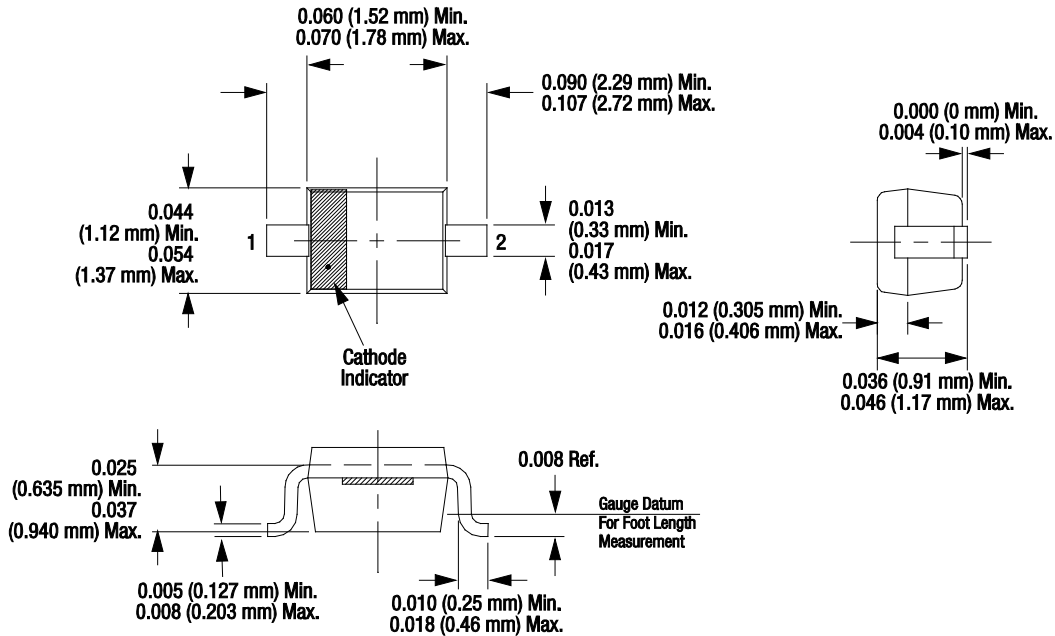

Figure 5. SPICE Model

Table 5. SPICE Model Parameters

Part Number	C <sub>J0</sub> (pF)	V <sub>J</sub> (V)	V <sub>B</sub> (V)	M	C <sub>P</sub> (pF)	R <sub>S</sub> (Ω)
SMV1142	13.38	2.20	12	1.00	0	0.70
SMV1143	18.99	2.20	12	1.00	0	0.65
SMV1144	24.01	2.20	12	1.00	0	0.65
SMV1145	41.80	2.50	12	1.10	0	0.60
SMV1147	89.52	2.50	12	1.10	0	0.55
SMV1148	105.00	2.31	12	1.07	0	0.50





Dimensions are in inches (millimeters shown in parentheses)

S1619

Figure 8. SOD-323 Package Dimensions

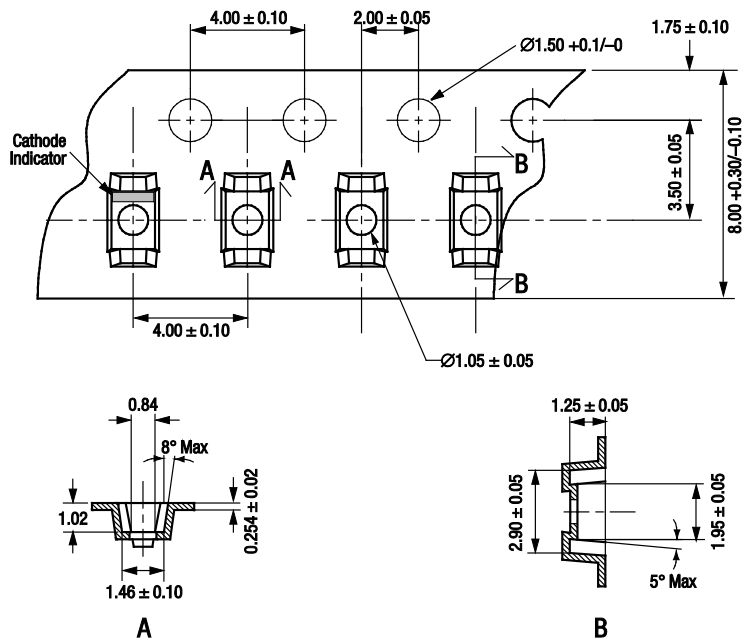

Notes:

1. Carrier tape: black conductive polycarbonate or polystyrene.
2. Cover tape: transparent conductive material.
3. Cover tape size: 5.5 mm width.
4. ESD surface resistivity is  $\geq 1 \times 10^5 \sim \leq 1 \times 10^{11}$  Ohms/square.
5. 10 sprocket hole pitch cumulative tolerance:  $\pm 0.20$  mm.
6.  $A_o$  and  $B_o$  measured on plane 0.30 mm above bottom of the pocket.
7. All measurements are in millimeters.
8. Standard reel size is 7 inches. Standard reel quantity is 3000 pcs.

S2061

Figure 9. SOD-323 Tape and Reel Dimensions

Copyright © 2002-2009, 2010, 2011 Skyworks Solutions, Inc. All Rights Reserved.

Information in this document is provided in connection with Skyworks Solutions, Inc. ("Skyworks") products or services. These materials, including the information contained herein, are provided by Skyworks as a service to its customers and may be used for informational purposes only by the customer. Skyworks assumes no responsibility for errors or omissions in these materials or the information contained herein. Skyworks may change its documentation, products, services, specifications or product descriptions at any time, without notice. Skyworks makes no commitment to update the materials or information and shall have no responsibility whatsoever for conflicts, incompatibilities, or other difficulties arising from any future changes.

No license, whether express, implied, by estoppel or otherwise, is granted to any intellectual property rights by this document. Skyworks assumes no liability for any materials, products or information provided hereunder, including the sale, distribution, reproduction or use of Skyworks products, information or materials, except as may be provided in Skyworks Terms and Conditions of Sale.

THE MATERIALS, PRODUCTS AND INFORMATION ARE PROVIDED "AS IS" WITHOUT WARRANTY OF ANY KIND, WHETHER EXPRESS, IMPLIED, STATUTORY, OR OTHERWISE, INCLUDING FITNESS FOR A PARTICULAR PURPOSE OR USE, MERCHANTABILITY, PERFORMANCE, QUALITY OR NON-INFRINGEMENT OF ANY INTELLECTUAL PROPERTY RIGHT; ALL SUCH WARRANTIES ARE HEREBY EXPRESSLY DISCLAIMED. SKYWORKS DOES NOT WARRANT THE ACCURACY OR COMPLETENESS OF THE INFORMATION, TEXT, GRAPHICS OR OTHER ITEMS CONTAINED WITHIN THESE MATERIALS. SKYWORKS SHALL NOT BE LIABLE FOR ANY DAMAGES, INCLUDING BUT NOT LIMITED TO ANY SPECIAL, INDIRECT, INCIDENTAL, STATUTORY, OR CONSEQUENTIAL DAMAGES, INCLUDING WITHOUT LIMITATION, LOST REVENUES OR LOST PROFITS THAT MAY RESULT FROM THE USE OF THE MATERIALS OR INFORMATION, WHETHER OR NOT THE RECIPIENT OF MATERIALS HAS BEEN ADVISED OF THE POSSIBILITY OF SUCH DAMAGE.



Skyworks products are not intended for use in medical, lifesaving or life-sustaining applications, or other equipment in which the failure of the Skyworks products could lead to personal injury, death, physical or environmental damage. Skyworks customers using or selling Skyworks products for use in such applications do so at their own risk and agree to fully indemnify Skyworks for any damages resulting from such improper use or sale.

Customers are responsible for their products and applications using Skyworks products, which may deviate from published specifications as a result of design defects, errors, or operation of products outside of published parameters or design specifications. Customers should include design and operating safeguards to minimize these and other risks. Skyworks assumes no liability for applications assistance, customer product design, or damage to any equipment resulting from the use of Skyworks products outside of stated published specifications or parameters.

Skyworks, the Skyworks symbol, and "Breakthrough Simplicity" are trademarks or registered trademarks of Skyworks Solutions, Inc., in the United States and other countries. Third-party brands and names are for identification purposes only, and are the property of their respective owners. Additional information, including relevant terms and conditions, posted at [www.skyworksinc.com](http://www.skyworksinc.com), are incorporated by reference.

## Looking for pricing, stock, or lifecycle information?

Click below to explore more details on WIN SOURCE:

-  [View SMV1142-011 on WIN SOURCE](#)
-  [Skyworks Solutions Inc. Information](#)

## Optimize Your Supply Chain with WIN SOURCE Solutions

-  Global Sourcing Solution
-  Obsolete Management
-  Cost Control Management
-  Shortage Management
-  Alternative Solution
-  Excess Inventory Management