



# SN54ALS804A, SN54AS804B, SN74ALS804A, SN74AS804B HEX 2-INPUT NAND DRIVERS

SDAS022C – DECEMBER 1982 – REVISED JANUARY 1995

- High Capacitive-Drive Capability
- 'ALS804A Has Typical Delay Time of 4 ns ( $C_L = 50$  pF) and Typical Power Dissipation of 3.4 mW Per Gate
- 'AS804B Has Typical Delay Time of 2.6 ns ( $C_L = 50$  pF) and Typical Power Dissipation of Less Than 9 mW Per Gate
- Package Options Include Plastic Small-Outline (DW) Packages, Ceramic Chip Carriers (FK), and Standard Plastic (N) and Ceramic (J) 300-mil DIPs

## description

These devices contain six independent 2-input NAND drivers. They perform the Boolean functions  $Y = A \cdot B$  or  $Y = \overline{A + B}$  in positive logic.

The SN54ALS804A and SN54AS804B are characterized for operation over the full military temperature range of  $-55^\circ\text{C}$  to  $125^\circ\text{C}$ . The SN74ALS804A and SN74AS804B are characterized for operation from  $0^\circ\text{C}$  to  $70^\circ\text{C}$ .

FUNCTION TABLE  
(each driver)

INPUTS		OUTPUT
A	B	Y
H	H	L
L	X	H
X	L	H

SN54ALS804A, SN54AS804B . . . J PACKAGE  
SN74ALS804A, SN74AS804B . . . DW OR N PACKAGE  
(TOP VIEW)

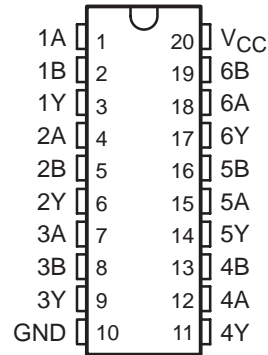

SN54ALS804A, SN54AS804B . . . FK PACKAGE  
(TOP VIEW)

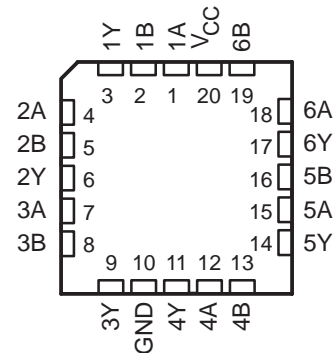

## logic symbol†

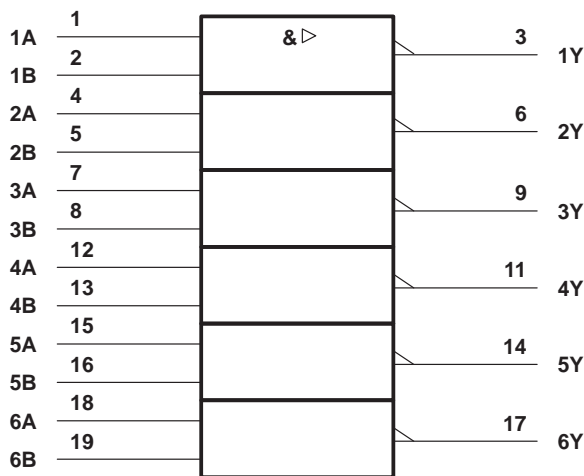

## logic diagram (positive logic)

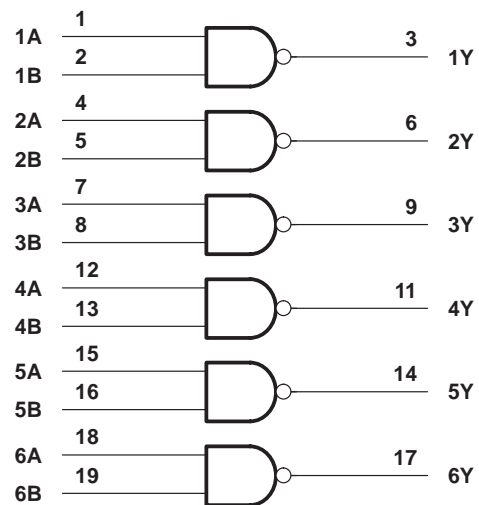

† This symbol is in accordance with ANSI/IEEE Std 91-1984 and IEC Publication 617-12.

PRODUCTION DATA information is current as of publication date. Products conform to specifications per the terms of Texas Instruments standard warranty. Production processing does not necessarily include testing of all parameters.

 **TEXAS  
INSTRUMENTS**

POST OFFICE BOX 655303 • DALLAS, TEXAS 75265  
POST OFFICE BOX 1443 • HOUSTON, TEXAS 77251-1443

Copyright © 1995, Texas Instruments Incorporated

# SN54ALS804A, SN54AS804B, SN74ALS804A, SN74AS804B HEX 2-INPUT NAND DRIVERS

SDAS022C – DECEMBER 1982 – REVISED JANUARY 1995

## absolute maximum ratings over operating free-air temperature range (unless otherwise noted)†

Supply voltage, $V_{CC}$	7 V
Input voltage, $V_I$	7 V
Operating free-air temperature range, $T_A$ : SN54ALS804A	-55°C to 125°C
SN74ALS804A	0°C to 70°C
Storage temperature range	-65°C to 150°C

† Stresses beyond those listed under "absolute maximum ratings" may cause permanent damage to the device. These are stress ratings only, and functional operation of the device at these or any other conditions beyond those indicated under "recommended operating conditions" is not implied. Exposure to absolute-maximum-rated conditions for extended periods may affect device reliability.

## recommended operating conditions

		SN54ALS804A			SN74ALS804A			UNIT
		MIN	NOM	MAX	MIN	NOM	MAX	
$V_{CC}$	Supply voltage	4.5	5	5.5	4.5	5	5.5	V
$V_{IH}$	High-level input voltage	2			2			V
$V_{IL}$	Low-level input voltage			0.7			0.8	V
$I_{OH}$	High-level output current			-12			-15	mA
$I_{OL}$	Low-level output current			12			24	mA
$T_A$	Operating free-air temperature	-55		125	0		70	°C

## electrical characteristics over recommended operating free-air temperature range (unless otherwise noted)

PARAMETER	TEST CONDITIONS	SN54ALS804A			SN74ALS804A			UNIT
		MIN	TYP‡	MAX	MIN	TYP‡	MAX	
$V_{IK}$	$V_{CC} = 4.5\text{ V}$ , $I_I = -18\text{ mA}$			-1.2			-1.2	V
$V_{OH}$	$V_{CC} = 4.5\text{ V to } 5.5\text{ V}$ , $I_{OH} = -0.4\text{ mA}$	$V_{CC} - 2$			$V_{CC} - 2$			V
	$V_{CC} = 4.5\text{ V}$	$I_{OH} = -3\text{ mA}$	2.4	3.2	2.4	3.2		
		$I_{OH} = -12\text{ mA}$	2		2			
$V_{OL}$	$V_{CC} = 4.5\text{ V}$	$I_{OL} = 12\text{ mA}$	0.25	0.4	0.25	0.4	V	
		$I_{OL} = 24\text{ mA}$			0.35	0.5		
$I_I$	$V_{CC} = 5.5\text{ V}$ , $V_I = 7\text{ V}$			0.1			0.1	mA
$I_{IH}$	$V_{CC} = 5.5\text{ V}$ , $V_I = 2.7\text{ V}$			20			20	μA
$I_{IL}$	$V_{CC} = 5.5\text{ V}$ , $V_I = 0.4\text{ V}$			-0.1			-0.1	mA
$I_{O}^{\S}$	$V_{CC} = 5.5\text{ V}$ , $V_O = 2.25\text{ V}$	-20		-112	-30		-112	mA
$I_{CCH}$	$V_{CC} = 5.5\text{ V}$ , $V_I = 0$		0.9	2.5		0.9	2.5	mA
$I_{CCL}$	$V_{CC} = 5.5\text{ V}$ , $V_I = 4.5\text{ V}$		7	12		7	12	mA

‡ All typical values are at  $V_{CC} = 5\text{ V}$ ,  $T_A = 25^\circ\text{C}$ .

§ The output conditions have been chosen to produce a current that closely approximates one half of the true short-circuit output current,  $I_{OS}$ .



# SN54ALS804A, SN54AS804B, SN74ALS804A, SN74AS804B HEX 2-INPUT NAND DRIVERS

SDAS022C – DECEMBER 1982 – REVISED JANUARY 1995

## switching characteristics (see Figure 1)

PARAMETER	FROM (INPUT)	TO (OUTPUT)	V <sub>CC</sub> = 4.5 V to 5.5 V, C <sub>L</sub> = 50 pF, R <sub>L</sub> = 500 Ω, T <sub>A</sub> = MIN to MAX†				UNIT
			SN54ALS804A		SN74ALS804A		
			MIN	MAX	MIN	MAX	
t <sub>PLH</sub>	A or B	Y	2	9	2	7	ns
t <sub>PHL</sub>			2	9	2	8	

† For conditions shown as MIN or MAX, use the appropriate value specified under recommended operating conditions.

## absolute maximum ratings over operating free-air temperature range (unless otherwise noted)‡

Supply voltage, V <sub>CC</sub> .....	7 V
Input voltage, V <sub>I</sub> .....	7 V
Operating free-air temperature range, T <sub>A</sub> : SN54AS804B .....	–55°C to 125°C
SN74AS804B .....	0°C to 70°C
Storage temperature range .....	–65°C to 150°C

‡ Stresses beyond those listed under “absolute maximum ratings” may cause permanent damage to the device. These are stress ratings only, and functional operation of the device at these or any other conditions beyond those indicated under “recommended operating conditions” is not implied. Exposure to absolute-maximum-rated conditions for extended periods may affect device reliability.

## recommended operating conditions§

	SN54AS804B			SN74AS804B			UNIT
	MIN	NOM	MAX	MIN	NOM	MAX	
V <sub>CC</sub> Supply voltage	4.5	5	5.5	4.5	5	5.5	V
V <sub>IH</sub> High-level input voltage	2			2			V
V <sub>IL</sub> Low-level input voltage			0.8			0.8	V
I <sub>OH</sub> High-level output current			–40			–48	mA
I <sub>OL</sub> Low-level output current			40			48	mA
T <sub>A</sub> Operating free-air temperature	–55		125	0		70	°C

§ These high sink- or source-current devices are not recommended for use above 40 MHz.



# SN54ALS804A, SN54AS804B, SN74ALS804A, SN74AS804B HEX 2-INPUT NAND DRIVERS

SDAS022C – DECEMBER 1982 – REVISED JANUARY 1995

electrical characteristics over recommended operating free-air temperature range (unless otherwise noted)

PARAMETER	TEST CONDITIONS		SN54AS804B			SN74AS804B			UNIT
			MIN	TYP†	MAX	MIN	TYP†	MAX	
$V_{IK}$	$V_{CC} = 4.5\text{ V}$ ,	$I_I = -18\text{ mA}$			-1.2			-1.2	V
$V_{OH}$	$V_{CC} = 4.5\text{ V to } 5.5\text{ V}$ ,	$I_{OH} = -2\text{ mA}$	$V_{CC} - 2$			$V_{CC} - 2$			V
	$V_{CC} = 4.5\text{ V}$	$I_{OH} = -3\text{ mA}$	2.4	3.2		2.4	3.2		
		$I_{OH} = -40\text{ mA}$	2			2			
$V_{OL}$	$V_{CC} = 4.5\text{ V}$	$I_{OL} = 40\text{ mA}$	0.25		0.5			V	
		$I_{OL} = 48\text{ mA}$			0.35		0.5		
$I_I$	$V_{CC} = 5.5\text{ V}$ ,	$V_I = 7\text{ V}$			0.1		0.1	mA	
$I_{IH}$	$V_{CC} = 5.5\text{ V}$ ,	$V_I = 2.7\text{ V}$			20		20	$\mu\text{A}$	
$I_{IL}$	$V_{CC} = 5.5\text{ V}$ ,	$V_I = 0.4\text{ V}$			-0.5		-0.5	mA	
$I_{O\ddagger}$	$V_{CC} = 5.5\text{ V}$ ,	$V_O = 2.25\text{ V}$	-50		-200	-50		-200	mA
$I_{CCH}$	$V_{CC} = 5.5\text{ V}$ ,	$V_I = 0$		3.5	5		3.5	5	mA
$I_{CCL}$	$V_{CC} = 5.5\text{ V}$ ,	$V_I = 4.5\text{ V}$		16	27		16	27	mA

† All typical values are at  $V_{CC} = 5\text{ V}$ ,  $T_A = 25^\circ\text{C}$ .

‡ The output conditions have been chosen to produce a current that closely approximates one half of the true short-circuit output current,  $I_{OS}$ .

## switching characteristics (see Figure 1)

PARAMETER	FROM (INPUT)	TO (OUTPUT)	$V_{CC} = 4.5\text{ V to } 5.5\text{ V}$ , $C_L = 50\text{ pF}$ , $R_L = 500\ \Omega$ , $T_A = \text{MIN to MAX}^\S$				UNIT
			SN54AS804B		SN74AS804B		
			MIN	MAX	MIN	MAX	
$t_{PLH}$	A or B	Y	1	5	1	4	ns
$t_{PHL}$			1	5	1	4	

§ For conditions shown as MIN or MAX, use the appropriate value specified under recommended operating conditions.



PARAMETER MEASUREMENT INFORMATION  
 SERIES 54ALS/74ALS AND 54AS/74AS DEVICES



- NOTES: A.  $C_L$  includes probe and jig capacitance.  
 B. Waveform 1 is for an output with internal conditions such that the output is low except when disabled by the output control. Waveform 2 is for an output with internal conditions such that the output is high except when disabled by the output control.  
 C. When measuring propagation delay items of 3-state outputs, switch S1 is open.  
 D. All input pulses have the following characteristics:  $PRR \leq 1$  MHz,  $t_r = t_f = 2$  ns, duty cycle = 50%.  
 E. The outputs are measured one at a time with one transition per measurement.

Figure 1. Load Circuits and Voltage Waveforms

**PACKAGING INFORMATION**

Orderable Device	Status (1)	Package Type	Package Drawing	Pins	Package Qty	Eco Plan (2)	Lead/Ball Finish (6)	MSL Peak Temp (3)	Op Temp (°C)	Device Marking (4/5)	Samples
5962-87766012A	ACTIVE	LCCC	FK	20	1	TBD	POST-PLATE	N / A for Pkg Type	-55 to 125	5962- 87766012A SNJ54AS 804BFB	<a href="#">Samples</a>
5962-8776601RA	ACTIVE	CDIP	J	20	1	TBD	A42	N / A for Pkg Type	-55 to 125	5962-8776601RA SNJ54AS804BJ	<a href="#">Samples</a>
5962-8776601SA	ACTIVE	CFP	W	20	1	TBD	A42	N / A for Pkg Type	-55 to 125	5962-8776601SA SNJ54AS804BW	<a href="#">Samples</a>
5962-88693012A	ACTIVE	LCCC	FK	20	1	TBD	POST-PLATE	N / A for Pkg Type	-55 to 125	5962- 88693012A SNJ54ALS 804AFK	<a href="#">Samples</a>
5962-8869301RA	ACTIVE	CDIP	J	20	1	TBD	A42	N / A for Pkg Type	-55 to 125	5962-8869301RA SNJ54ALS804AJ	<a href="#">Samples</a>
SN54ALS804AJ	ACTIVE	CDIP	J	20	1	TBD	A42	N / A for Pkg Type	-55 to 125	SN54ALS804AJ	<a href="#">Samples</a>
SN54AS804BJ	ACTIVE	CDIP	J	20	1	TBD	A42	N / A for Pkg Type	-55 to 125	SN54AS804BJ	<a href="#">Samples</a>
SN74ALS804AN	ACTIVE	PDIP	N	20	20	Pb-Free (RoHS)	CU NIPDAU	N / A for Pkg Type	0 to 70	SN74ALS804AN	<a href="#">Samples</a>
SN74AS804BDW	NRND	SOIC	DW	20	25	Green (RoHS & no Sb/Br)	CU NIPDAU	Level-1-260C-UNLIM	0 to 70	AS804B	
SN74AS804BN	NRND	PDIP	N	20	20	Pb-Free (RoHS)	CU NIPDAU	N / A for Pkg Type	0 to 70	SN74AS804BN	
SNJ54ALS804AFK	ACTIVE	LCCC	FK	20	1	TBD	POST-PLATE	N / A for Pkg Type	-55 to 125	5962- 88693012A SNJ54ALS 804AFK	<a href="#">Samples</a>
SNJ54ALS804AJ	ACTIVE	CDIP	J	20	1	TBD	A42	N / A for Pkg Type	-55 to 125	5962-8869301RA SNJ54ALS804AJ	<a href="#">Samples</a>
SNJ54AS804BFB	ACTIVE	LCCC	FK	20	1	TBD	POST-PLATE	N / A for Pkg Type	-55 to 125	5962- 87766012A SNJ54AS 804BFB	<a href="#">Samples</a>
SNJ54AS804BJ	ACTIVE	CDIP	J	20	1	TBD	A42	N / A for Pkg Type	-55 to 125	5962-8776601RA SNJ54AS804BJ	<a href="#">Samples</a>

Orderable Device	Status (1)	Package Type	Package Drawing	Pins	Package Qty	Eco Plan (2)	Lead/Ball Finish (6)	MSL Peak Temp (3)	Op Temp (°C)	Device Marking (4/5)	Samples
SNJ54AS804BW	ACTIVE	CFP	W	20	1	TBD	A42	N / A for Pkg Type	-55 to 125	5962-8776601SA SNJ54AS804BW	<b>Samples</b>

(1) The marketing status values are defined as follows:

**ACTIVE:** Product device recommended for new designs.

**LIFEBUY:** TI has announced that the device will be discontinued, and a lifetime-buy period is in effect.

**NRND:** Not recommended for new designs. Device is in production to support existing customers, but TI does not recommend using this part in a new design.

**PREVIEW:** Device has been announced but is not in production. Samples may or may not be available.

**OBSOLETE:** TI has discontinued the production of the device.

(2) **RoHS:** TI defines "RoHS" to mean semiconductor products that are compliant with the current EU RoHS requirements for all 10 RoHS substances, including the requirement that RoHS substance do not exceed 0.1% by weight in homogeneous materials. Where designed to be soldered at high temperatures, "RoHS" products are suitable for use in specified lead-free processes. TI may reference these types of products as "Pb-Free".

**RoHS Exempt:** TI defines "RoHS Exempt" to mean products that contain lead but are compliant with EU RoHS pursuant to a specific EU RoHS exemption.

**Green:** TI defines "Green" to mean the content of Chlorine (Cl) and Bromine (Br) based flame retardants meet JS709B low halogen requirements of <=1000ppm threshold. Antimony trioxide based flame retardants must also meet the <=1000ppm threshold requirement.

(3) MSL, Peak Temp. - The Moisture Sensitivity Level rating according to the JEDEC industry standard classifications, and peak solder temperature.

(4) There may be additional marking, which relates to the logo, the lot trace code information, or the environmental category on the device.

(5) Multiple Device Markings will be inside parentheses. Only one Device Marking contained in parentheses and separated by a "~" will appear on a device. If a line is indented then it is a continuation of the previous line and the two combined represent the entire Device Marking for that device.

(6) Lead/Ball Finish - Orderable Devices may have multiple material finish options. Finish options are separated by a vertical ruled line. Lead/Ball Finish values may wrap to two lines if the finish value exceeds the maximum column width.

**Important Information and Disclaimer:**The information provided on this page represents TI's knowledge and belief as of the date that it is provided. TI bases its knowledge and belief on information provided by third parties, and makes no representation or warranty as to the accuracy of such information. Efforts are underway to better integrate information from third parties. TI has taken and continues to take reasonable steps to provide representative and accurate information but may not have conducted destructive testing or chemical analysis on incoming materials and chemicals. TI and TI suppliers consider certain information to be proprietary, and thus CAS numbers and other limited information may not be available for release.

In no event shall TI's liability arising out of such information exceed the total purchase price of the TI part(s) at issue in this document sold by TI to Customer on an annual basis.

**OTHER QUALIFIED VERSIONS OF SN54ALS804A, SN54AS804B, SN74ALS804A, SN74AS804B :**

● Catalog: [SN74ALS804A](#), [SN74AS804B](#)

- Military: [SN54ALS804A](#), [SN54AS804B](#)

NOTE: Qualified Version Definitions:

- Catalog - TI's standard catalog product
- Military - QML certified for Military and Defense Applications

W (R-GDFP-F20)

CERAMIC DUAL FLATPACK

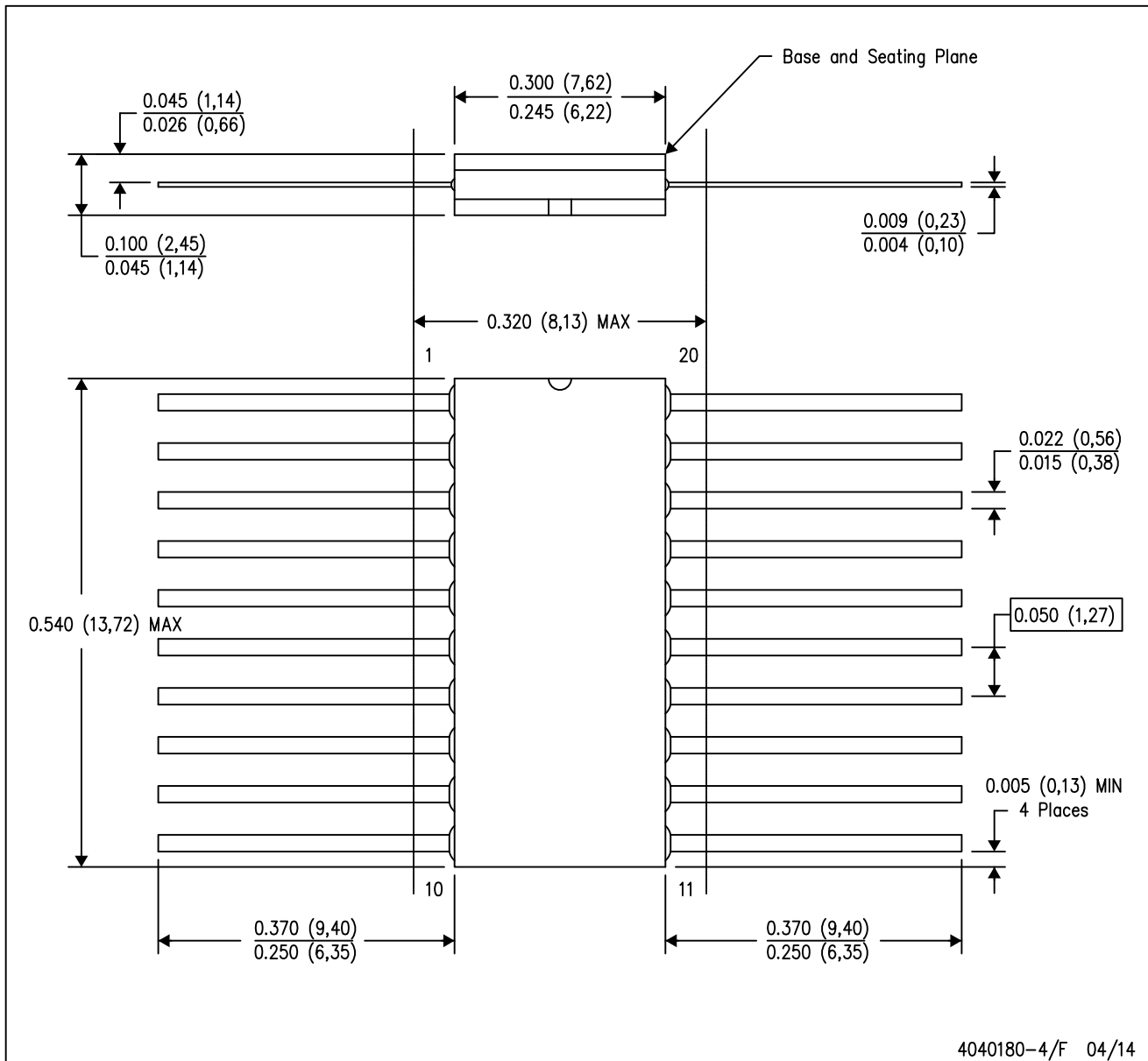

- NOTES:
- A. All linear dimensions are in inches (millimeters).
  - B. This drawing is subject to change without notice.
  - C. This package can be hermetically sealed with a ceramic lid using glass frit.
  - D. Index point is provided on cap for terminal identification only.
  - E. Falls within Mil-Std 1835 GDFP2-F20

FK (S-CQCC-N\*\*)

LEADLESS CERAMIC CHIP CARRIER

28 TERMINAL SHOWN



NO. OF TERMINALS **	A		B	
	MIN	MAX	MIN	MAX
20	0.342 (8,69)	0.358 (9,09)	0.307 (7,80)	0.358 (9,09)
28	0.442 (11,23)	0.458 (11,63)	0.406 (10,31)	0.458 (11,63)
44	0.640 (16,26)	0.660 (16,76)	0.495 (12,58)	0.560 (14,22)
52	0.740 (18,78)	0.761 (19,32)	0.495 (12,58)	0.560 (14,22)
68	0.938 (23,83)	0.962 (24,43)	0.850 (21,6)	0.858 (21,8)
84	1.141 (28,99)	1.165 (29,59)	1.047 (26,6)	1.063 (27,0)

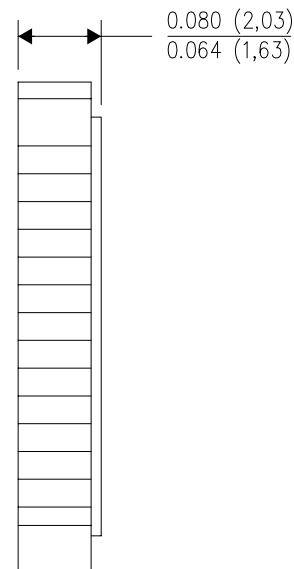
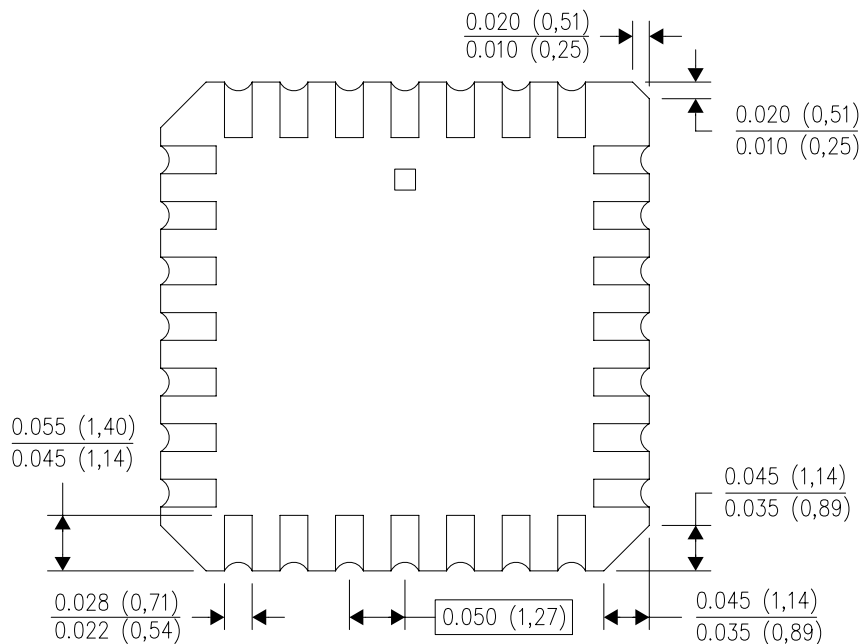

4040140/D 01/11

- NOTES:
- All linear dimensions are in inches (millimeters).
  - This drawing is subject to change without notice.
  - This package can be hermetically sealed with a metal lid.
  - Falls within JEDEC MS-004

J (R-GDIP-T\*\*)

14 LEADS SHOWN

CERAMIC DUAL IN-LINE PACKAGE



DIM \ PINS **	14	16	18	20
A	0.300 (7,62) BSC	0.300 (7,62) BSC	0.300 (7,62) BSC	0.300 (7,62) BSC
B MAX	0.785 (19,94)	.840 (21,34)	0.960 (24,38)	1.060 (26,92)
B MIN	—	—	—	—
C MAX	0.300 (7,62)	0.300 (7,62)	0.310 (7,87)	0.300 (7,62)
C MIN	0.245 (6,22)	0.245 (6,22)	0.220 (5,59)	0.245 (6,22)



4040083/F 03/03

- NOTES:
- All linear dimensions are in inches (millimeters).
  - This drawing is subject to change without notice.
  - This package is hermetically sealed with a ceramic lid using glass frit.
  - Index point is provided on cap for terminal identification only on press ceramic glass frit seal only.
  - Falls within MIL STD 1835 GDIP1-T14, GDIP1-T16, GDIP1-T18 and GDIP1-T20.

N (R-PDIP-T\*\*)

PLASTIC DUAL-IN-LINE PACKAGE

16 PINS SHOWN



- NOTES:
- A. All linear dimensions are in inches (millimeters).
  - B. This drawing is subject to change without notice.
  - Falls within JEDEC MS-001, except 18 and 20 pin minimum body length (Dim A).
  - The 20 pin end lead shoulder width is a vendor option, either half or full width.

# DW0020A



# PACKAGE OUTLINE

## SOIC - 2.65 mm max height

SOIC



4220724/A 05/2016

**NOTES:**

1. All linear dimensions are in millimeters. Dimensions in parenthesis are for reference only. Dimensioning and tolerancing per ASME Y14.5M.
2. This drawing is subject to change without notice.
3. This dimension does not include mold flash, protrusions, or gate burrs. Mold flash, protrusions, or gate burrs shall not exceed 0.15 mm per side.
4. This dimension does not include interlead flash. Interlead flash shall not exceed 0.43 mm per side.
5. Reference JEDEC registration MS-013.

# EXAMPLE BOARD LAYOUT

DW0020A

SOIC - 2.65 mm max height

SOIC



LAND PATTERN EXAMPLE  
SCALE:6X



SOLDER MASK DETAILS

4220724/A 05/2016

NOTES: (continued)

- 6. Publication IPC-7351 may have alternate designs.
- 7. Solder mask tolerances between and around signal pads can vary based on board fabrication site.

# EXAMPLE STENCIL DESIGN

DW0020A

SOIC - 2.65 mm max height

SOIC



SOLDER PASTE EXAMPLE  
BASED ON 0.125 mm THICK STENCIL  
SCALE:6X

4220724/A 05/2016

NOTES: (continued)

8. Laser cutting apertures with trapezoidal walls and rounded corners may offer better paste release. IPC-7525 may have alternate design recommendations.
9. Board assembly site may have different recommendations for stencil design.

## IMPORTANT NOTICE AND DISCLAIMER

TI PROVIDES TECHNICAL AND RELIABILITY DATA (INCLUDING DATASHEETS), DESIGN RESOURCES (INCLUDING REFERENCE DESIGNS), APPLICATION OR OTHER DESIGN ADVICE, WEB TOOLS, SAFETY INFORMATION, AND OTHER RESOURCES "AS IS" AND WITH ALL FAULTS, AND DISCLAIMS ALL WARRANTIES, EXPRESS AND IMPLIED, INCLUDING WITHOUT LIMITATION ANY IMPLIED WARRANTIES OF MERCHANTABILITY, FITNESS FOR A PARTICULAR PURPOSE OR NON-INFRINGEMENT OF THIRD PARTY INTELLECTUAL PROPERTY RIGHTS.

These resources are intended for skilled developers designing with TI products. You are solely responsible for (1) selecting the appropriate TI products for your application, (2) designing, validating and testing your application, and (3) ensuring your application meets applicable standards, and any other safety, security, or other requirements. These resources are subject to change without notice. TI grants you permission to use these resources only for development of an application that uses the TI products described in the resource. Other reproduction and display of these resources is prohibited. No license is granted to any other TI intellectual property right or to any third party intellectual property right. TI disclaims responsibility for, and you will fully indemnify TI and its representatives against, any claims, damages, costs, losses, and liabilities arising out of your use of these resources.

TI's products are provided subject to TI's Terms of Sale ([www.ti.com/legal/termsofsale.html](http://www.ti.com/legal/termsofsale.html)) or other applicable terms available either on [ti.com](http://ti.com) or provided in conjunction with such TI products. TI's provision of these resources does not expand or otherwise alter TI's applicable warranties or warranty disclaimers for TI products.

Mailing Address: Texas Instruments, Post Office Box 655303, Dallas, Texas 75265  
Copyright © 2019, Texas Instruments Incorporated

## Looking for pricing, stock, or lifecycle information?

Click below to explore more details on WIN SOURCE:

 [View SN74ALS804AN](#) on WIN SOURCE

 [Texas Instruments](#) Information

## Optimize Your Supply Chain with WIN SOURCE Solutions

-  Global Sourcing Solution
-  Obsolete Management
-  Cost Control Management
-  Shortage Management
-  Alternative Solution
-  Excess Inventory Management