



**THE DATASHEET OF  
SP6132HEU-L/TR**





# SP6132H

## High Voltage, 300KHz Synchronous PWM Controller

### FEATURES

- 3V to 28V Step Down Achieved Using Dual Input
- On-Board  $1.5\Omega$  sink ( $2\Omega$  source) NFET Drivers
- Up to 30A Output Capability
- Highly Integrated Design, Minimal Components
- UVLO Detects Both  $V_{CC}$  and  $V_{IN}$
- Short Circuit Protection with Auto-Restart
- Wide BW Amp Allows Type II or III Compensation
- Programmable Soft Start
- Fast Transient Response
- High Efficiency: Greater than 95% Possible
- A Synchronous Start-Up into a Pre-Charged Output
- Small 10-Pin MSOP Package
- U.S. Patent #6,922,041

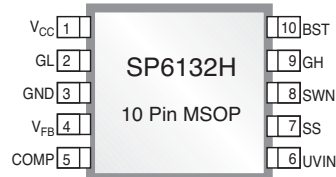

Now Available in Lead Free Packaging

### APPLICATIONS

- Wireless Base Station
- Automotive
- Industrial
- Power Supply

### DESCRIPTION

The SP6132H is a synchronous step-down switching regulator controller optimized for high efficiency. The part is designed to be especially attractive for dual supply, 12V step down with 5V used to power the controller. This lower  $V_{CC}$  voltage minimizes power dissipation in the part. The SP6132H is designed to drive a pair of external NFETs using a fixed 300kHz frequency, PWM voltage mode architecture. Protection features include UVLO, thermal shutdown and output short circuit protection. The SP6132H is available in the cost and space saving 10-pin MSOP.

### TYPICAL APPLICATION CIRCUIT

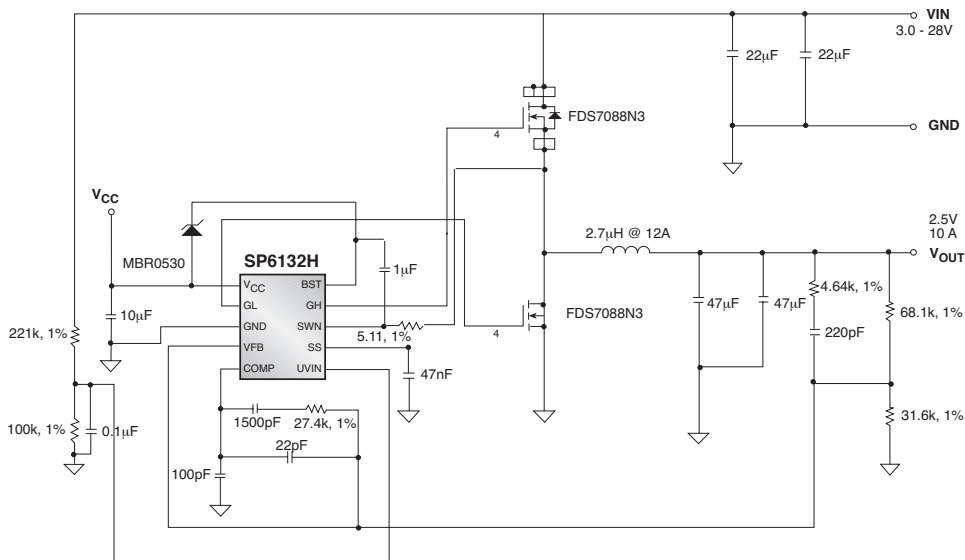

## ABSOLUTE MAXIMUM RATINGS

These are stress ratings only and functional operation of the device at these ratings or any other above those indicated in the operation sections of the specifications below is not implied. Exposure to absolute maximum rating conditions for extended periods of time may affect reliability.

V <sub>CC</sub> .....	7V
BST .....	33V
BST-SWN .....	-0.3V to 7V
SWN .....	-1V to 30V
GH .....	-0.3V to BST+0.3V
GH-SWN .....	7V
All other pins .....	-0.3V to V <sub>CC</sub> +0.3V

Peak Output Current < 10us .....	2A
GH, GL .....	2A
Storage Temperature .....	-65°C to 150°C
Power Dissipation .....	1W
Lead Temperature (Soldering, 10 sec) .....	300°C
ESD Rating .....	2kV HBM
Thermal Resistance .....	41.9°C/W

## ELECTRICAL SPECIFICATIONS

Unless otherwise specified: 0°C < T<sub>AMB</sub> < 70°C, 4.5V < V<sub>CC</sub> < 5.5V, BST=V<sub>CC</sub>, SWN = GND = ZeroV, UV<sub>IN</sub> = 3.0V, CV<sub>CC</sub> = 10μF, C<sub>COMP</sub> = 0.1μF, CGH = CGL = 3.3nF, C<sub>SS</sub> = 50nF, Typical measured at V<sub>CC</sub>=5V. The ♦ denotes the specifications which apply over the -40°C to 85°C temperature range, unless otherwise specified.

PARAMETER	MIN	TYP	MAX	UNITS		CONDITIONS
<b>QUIESCENT CURRENT</b>						
V <sub>CC</sub> Supply Current		1.5	3	mA	♦	V <sub>FB</sub> = 0.9V (No switching)
BST Supply Current		0.2	0.4	mA	♦	V <sub>FB</sub> = 0.9V (No switching)
<b>PROTECTION: UVLO</b>						
V <sub>CC</sub> UVLO Start Threshold	4.00	4.25	4.5	V		
V <sub>CC</sub> UVLO Hysteresis	100	200	300	mV		
UVIN Start Threshold	2.3	2.5	2.65	V		
UVIN Hysteresis	200	300	400	mV		
UVIN Input Current			1	μA		UVIN = 3.0V
<b>ERROR AMPLIFIER REFERENCE</b>						
Error Amplifier Reference	0.792	0.800	0.808	V		2X Gain Config., Measure V <sub>FB</sub>
Error Amplifier Reference Over Line and Temperature	0.788	0.800	0.812	V	♦	
Error Amplifier Transconductance		6		ms		
Error Amplifier Gain		60		dB		No Load
COMP Sink Current		150		μA		V <sub>FB</sub> = 0.9V, COMP = 0.9V
COMP Source Current		150		μA		V <sub>FB</sub> = 0.7V, COMP = 2.2V
V <sub>FB</sub> Input Bias Current		50	200	nA	♦	V <sub>FB</sub> = 0.8V
Internal Pole		4		MHz		
COMP Clamp		2.5		V		V <sub>FB</sub> =0.7V, T <sub>A</sub> = 25°C
COMP Clamp Temp. Coefficient		-2		mV/°C		
<b>CONTROL LOOP: PWM COMPARATOR, RAMP &amp; LOOP DELAY PATH</b>						
Ramp Amplitude	0.92	1.1	1.28	V	♦	
RAMP Offset		1.1		V		T <sub>A</sub> = 25°C, RAMP COMP until GH starts switching
RAMP Offset Temp. Coefficient		-2		mV/°C		
GH Minimum Pulse Width		90	180	ns		
Maximum Controllable Duty Ratio	92	97		%	♦	Maximum Duty Ratio Measured just before pulse skipping begins
Maximum Duty Ratio	100			%		Valid for 20 Cycles
Internal Oscillator Frequency	255 240	300 300	345 360	kHz	♦	

## ELECTRICAL SPECIFICATIONS: Continued

Unless otherwise specified:  $0^{\circ}\text{C} < T_{\text{AMB}} < 70^{\circ}\text{C}$ ,  $4.5\text{V} < V_{\text{CC}} < 5.5\text{V}$ ,  $\text{BST} = V_{\text{CC}}$ ,  $\text{SWN} = \text{GND} = \text{ZeroV}$ ,  $\text{UVIN} = 3.0\text{V}$ ,  $\text{CV}_{\text{CC}} = 10\mu\text{F}$ ,  $\text{C}_{\text{COMP}} = 0.1\mu\text{F}$ ,  $\text{CGH} = \text{CGL} = 3.3\text{nF}$ ,  $\text{C}_{\text{SS}} = 50\text{nF}$ , Typical measured at  $V_{\text{CC}} = 5\text{V}$ . The  $\blacklozenge$  denotes the specifications which apply over the full operating temperature range, unless otherwise specified.

PARAMETER	MIN	TYP	MAX	UNITS		CONDITIONS
<b>TIMERS: SOFTSTART</b>						
SS Charge Current:		10		$\mu\text{A}$		
SS Discharge Current:	1			$\text{mA}$	$\blacklozenge$	Fault Present, $\text{SS} = 0.2\text{V}$
<b>PROTECTION: SHORT CIRCUIT &amp; THERMAL</b>						
Short Circuit Threshold Voltage	0.2	0.25	0.3	V		Measured $V_{\text{REF}} (0.8\text{V}) - V_{\text{FB}}$
Hiccup Timeout		200		ms		$V_{\text{FB}} = 0.5\text{V}$
Number of Allowable Clock Cycles at 100% Duty Cycle		20		Cycles		$V_{\text{FB}} = 0.7\text{V}$
Minimum GL Pulse After 20 Cycles		0.5		Cycles		$V_{\text{FB}} = 0.7\text{V}$
Thermal Shutdown Temperature		145		$^{\circ}\text{C}$		
Thermal Recovery Temperature		135		$^{\circ}\text{C}$		
Thermal Hysteresis		10		$^{\circ}\text{C}$		
<b>OUTPUT: NFET GATE DRIVERS</b>						
GH & GL Rise Times		35	50	ns	$\blacklozenge$	Measured 10% to 90%
GH & GL Fall Times		30	40	ns	$\blacklozenge$	Measured 90% to 10%
GL to GH Non Overlap Time		45	70	ns	$\blacklozenge$	GH & GL Measured at 2.0V
SWN to GL Non Overlap Time		25	40	ns	$\blacklozenge$	Measured $\text{SWN} = 100\text{mV}$ to $\text{GL} = 2.0\text{V}$
GH & GL Pull Down Resistance	15	50	85	$\text{K}\Omega$	$\blacklozenge$	

## PIN DESCRIPTION

PIN #	PIN NAME	DESCRIPTION
1	$V_{\text{CC}}$	Bias Supply Input. Connect to external 5V supply. Used to power internal circuits and low side gate driver.
2	GL	High current driver output for the low side NFET switch. It is always low if GH is high or during a fault. Resistor pull down ensures low state at low voltage.
3	GND	Ground Pin. The control circuitry of the IC and lower power driver are referenced to this pin. Return separately from other ground traces to the (-) terminal of $\text{C}_{\text{OUT}}$ .
4	$V_{\text{FB}}$	Feedback Voltage and Short Circuit Detection pin. It is the inverting input of the Error Amplifier and serves as the output voltage feedback point for the Buck Converter. The output voltage is sensed and can be adjusted through an external resistor divider. Whenever $V_{\text{FB}}$ drops 0.25V below the positive reference, a short circuit fault is detected and the IC enters hiccup mode.
5	COMP	Output of the Error Amplifier. It is internally connected to the non-inverting input of the PWM comparator. An optimal filter combination is chosen and connected to this pin and either ground or $V_{\text{FB}}$ to stabilize the voltage mode loop.
6	UVIN	UVLO input for $V_{\text{IN}}$ voltage. Connect a resistor divider between $V_{\text{IN}}$ and $\text{UVIN}$ to set minimum operating voltage.
7	SS	Soft Start. Connect an external capacitor between SS and GND to set the soft start rate based on the $10\mu\text{A}$ source current. The SS pin is held low via a 1mA (min) current during all fault conditions.
8	SWN	Lower supply rail for the GH high-side gate driver. Connect this pin to the switching node at the junction between the two external power MOSFET transistors.
9	GH	High current driver output for the high side NFET switch. It is always low if GL is high or during a fault. Resistor pull down ensures low state at low voltage.
10	BST	High side driver supply pin. Connect BST to the external boost diode and capacitor as shown in the Typical Application Circuit on page 1. High side driver is connected between BST pin and SWN pin.

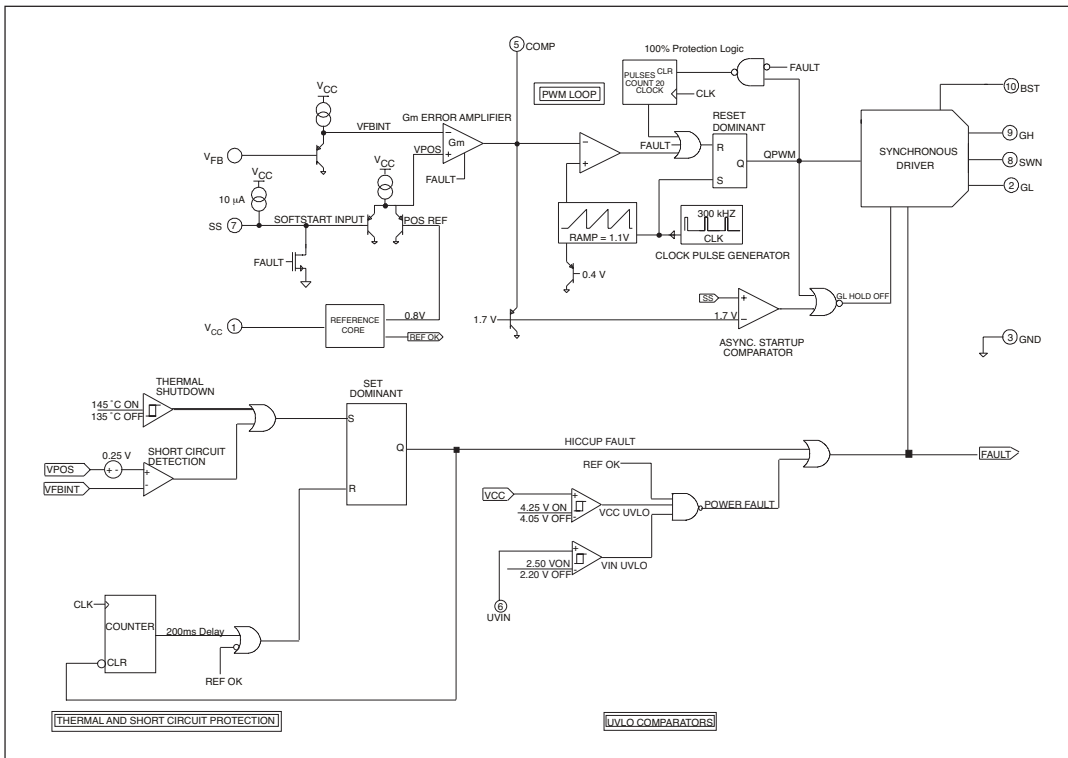

THEORY OF OPERATION

General Overview

The SP6132H is a fixed frequency, voltage mode, synchronous PWM controller optimized for high efficiency. The part has been designed to be especially attractive for split plane applications which utilize 5V to power the controller and 3V to 12V for step down conversion.

The heart of the SP6132H is a wide bandwidth transconductance amplifier designed to accommodate Type II and Type III compensation schemes. A precision 0.8V reference present on the positive terminal of the error amplifier permits the programming of the output voltage down to 0.8V via the V<sub>FB</sub> pin. The output of the error amplifier, COMP, compared to a 1.1V peak-to-peak ramp is responsible for trailing edge PWM control. This voltage ramp and PWM control logic are governed by the internal oscillator that accurately sets the PWM frequency to 300kHz.

The SP6132H contains two unique control features that are very powerful in distributed applications. First, asynchronous driver control is enabled during start up to prohibit the low side NFET from pulling down the output until the high side NFET has attempted to turn on. Second, a 100% duty cycle timeout ensures that the low side NFET is periodically enhanced during extended periods at 100% duty cycle. This guarantees the synchronized refreshing of the BST capacitor during very large duty ratios.

The SP6132H also contains a number of valuable protection features. A programmable input (V<sub>IN</sub>) UVLO allows a user to set the exact value at which the conversion voltage is at a safe point to begin down conversion, and an internal V<sub>CC</sub> UVLO ensures that the controller itself has enough voltage to properly operate. Other pro-

tection features include thermal shutdown and short-circuit detection. In the event that either a thermal, short-circuit, or UVLO fault is detected, the SP6132H is forced into an idle state where the output drivers are held off for a finite period before a re-start is attempted.

### Soft Start

“Soft Start” is achieved when a power converter ramps up the output voltage while controlling the magnitude of the input supply source current. In a modern step down converter, ramping up the positive terminal of the error amplifier controls soft start. As a result, excess source current can be defined as the current required to charge the output capacitor.

$$I_{V_{IN}} = C_{OUT} * \Delta V_{OUT} / \Delta T_{\text{Soft-start}}$$

The SP6132H provides the user with the option to program the soft start rate by tying a capacitor from the SS pin to GND. The selection of this capacitor is based on the 10uA pull up current present at the SS pin and the 0.8V reference voltage. Therefore, the excess source can be redefined as:

$$I_{V_{IN}} = C_{OUT} * \Delta V_{OUT} * 10\mu A / (C_{SS} * 0.8V)$$

### Under Voltage Lock Out (UVLO)

The SP6132H contains two separate UVLO comparators to monitor the bias ( $V_{CC}$ ) and conversion ( $V_{IN}$ ) voltages independently. The  $V_{CC}$  UVLO threshold is internally set to 4.25V, whereas the  $V_{IN}$  UVLO threshold is programmable through the UVIN pin. When the UVIN pin is greater than 2.5V, the SP6132H is permitted to start up pending the removal of all other faults. Both the  $V_{CC}$  and  $V_{IN}$  UVLO comparators have been designed with hysteresis to prevent noise from resetting a fault.

### Thermal and Short-Circuit Protection

Because the SP6132H is designed to drive large NFETs running at high current, there is a chance that either the controller or power converter will become too hot. Therefore, an internal thermal shutdown (145°C) has been included to prevent the IC from malfunctioning at extreme temperatures.

A short-circuit detection comparator has also been included in the SP6132H to protect against the accidental short or severe build up of current at the output of the power converter. This comparator constantly monitors the positive and negative terminals of the error amplifier, and if the  $V_{FB}$  pin ever falls more than 250mV (typical) below the positive reference, a short-circuit fault is set. Because the SS pin overrides the internal 0.8V reference during soft start, the SP6132H is capable of detecting short-circuit faults throughout the duration of soft start as well as in regular operation.

### Handling of Faults:

Upon the detection of power (UVLO), thermal, or short-circuit faults, the SP6132H is forced into an idle state where the SS and COMP pins are pulled low and the gate drivers are held off. In the event of UVLO fault, the SP6132H remains in this idle state until after the UVLO fault is removed. Upon the detection of thermal or short-circuit faults, an internal 200ms (typical) timer is activated. In the event of a short-circuit fault, a re-start is attempted immediately after the 200ms timeout expires. Whereas, when a thermal fault is detected the 200ms delay continuously recycles and a re-start cannot be attempted until the thermal fault is removed and the timer expires.

### Error Amplifier and Voltage Loop

As stated before, the heart of the SP6132H voltage error loop is a high performance, wide bandwidth transconductance amplifier. Because of the amplifier's current limited ( $\pm 150\mu\text{A}$ ) transconductance, there are many ways to compensate the voltage loop or to control the COMP pin externally. If a simple, single pole, single zero response is required, then compensation can be as simple as an RC circuit to ground. If a more complex compensation is required, then the amplifier has enough bandwidth ( $45^\circ$  at 4 MHz) and enough gain (60dB) to run Type III compensation schemes with adequate gain and phase margins at cross over frequencies greater than 50kHz.

The common mode output of the error amplifier is 0.9V to 2.2V. Therefore, the PWM voltage ramp has been set between 1.1V and 2.2V to ensure proper 0% to 100% duty cycle capability. The voltage loop also includes two other very important features. One is an asynchronous start up mode. Basically, the GL driver cannot turn on unless the GH driver has attempted to turn on or the SS pin has exceeded 1.7V. This feature prevents the controller from "dragging down" the output voltage during startup or in fault modes. The second feature is a 100% duty cycle timeout that ensures synchronized refreshing of the BST capacitor at very high duty ratios. In the event that the GH driver is on for 20 continuous clock cycles, a reset is given to the PWM flip flop half way through the 21st cycle. This forces GL to rise for the remainder of the cycle, in turn refreshing the BST capacitor.

### Gate Drivers

The SP6132H contains a pair of powerful  $2\Omega$  SOURCE and  $1.5\Omega$  SINK drivers. These state-of-the-art drivers are designed to drive external NFETs capable of handling up to 30A. Rise, fall, and non-overlap times have all been minimized to achieve maximum efficiency. All drive pins GH, GL & SWN are monitored continuously to ensure that only one external NFET is ever on at any given time.

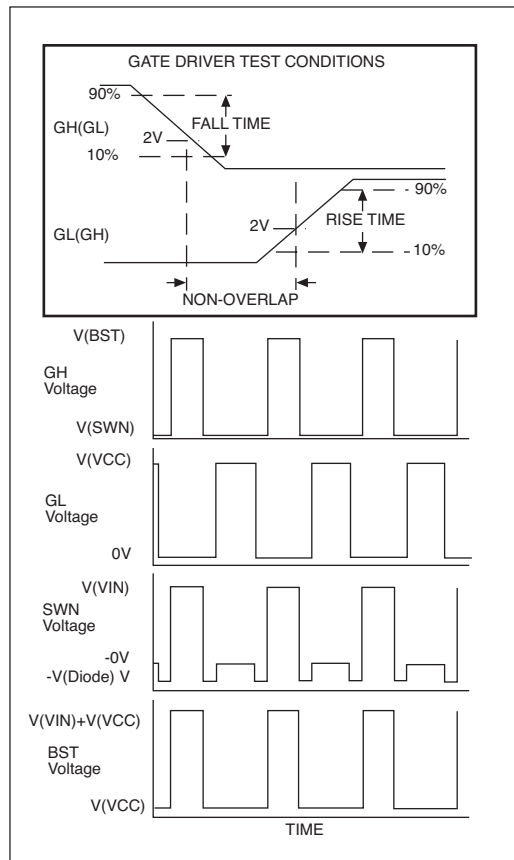

### Inductor Selection

There are many factors to consider in selecting the inductor including cost, efficiency, size and EMI. In a typical SP6132H circuit, the inductor is chosen primarily for value, saturation current and DC resistance. Increasing the inductor value will decrease output voltage ripple, but degrade transient response. Low inductor values provide the smallest size, but cause large ripple currents, poor efficiency and more output capacitance to smooth out the larger ripple current. The inductor must also be able to handle the peak current at the switching frequency without saturating, and the copper resistance in the winding should be kept as low as possible to minimize resistive power loss. A good compromise between size, loss and cost is to set the inductor ripple current to be within 20% to 40% of the maximum output current.

The switching frequency and the inductor operating point determine the inductor value as follows:

$$L = \frac{V_{OUT} (V_{IN(max)} - V_{OUT})}{V_{IN(max)} F_S K_r I_{OUT(max)}}$$

where:

$F_S$  = switching frequency

$K_r$  = ratio of the AC inductor ripple current to the maximum output current

The peak to peak inductor ripple current is:

$$I_{PP} = \frac{V_{OUT} (V_{IN(max)} - V_{OUT})}{V_{IN(max)} F_S L}$$

Once the required inductor value is selected, the proper selection of core material is based on peak inductor current and efficiency requirements. The core must be large enough not to saturate at the peak inductor current

$$I_{PEAK} = I_{OUT(max)} + \frac{I_{PP}}{2}$$

and provide low core loss at the high switching frequency. Low cost powdered iron cores have a gradual saturation characteristic but can introduce considerable AC core loss, especially when the inductor value is relatively low and the ripple current is high. Ferrite materials, on the other hand, are more expensive and have an abrupt saturation characteristic with the inductance dropping sharply when the peak design current is exceeded. Nevertheless, they are preferred at high switching frequencies because they present very low core loss and the design only needs to prevent saturation. In general, ferrite or molypermalloy materials are better choice for all but the most cost sensitive applications.

The power dissipated in the inductor is equal to the sum of the core and copper losses. To minimize copper losses, the winding resistance needs to be minimized, but this usually comes at the expense of a larger inductor. Core losses have a more significant contribution at low output current where the copper losses are at a minimum, and can typically be neglected at higher output currents where the copper losses dominate. Core loss information is usually available from the magnetics vendor.

The copper loss in the inductor can be calculated using the following equation:

$$P_{L(Cu)} = I_{L(RMS)}^2 R_{WINDING}$$

where  $I_{L(RMS)}$  is the RMS inductor current that can be calculated as follows:

$$I_{L(RMS)} = I_{OUT(max)} \sqrt{1 + \frac{1}{3} \left( \frac{I_{PP}}{I_{OUT(max)}} \right)^2}$$

### Output Capacitor Selection

The required ESR (Equivalent Series Resistance) and capacitance drive the selection of the type and quantity of the output capacitors. The ESR must be small enough that both the resistive voltage deviation due to a step change in the load current and the output ripple voltage do not exceed the tolerance limits expected on the output voltage. During an output load transient, the output capacitor must supply all the additional current demanded by the load until the SP6132HHVCU adjusts the inductor current to the new value.

Therefore the capacitance must be large enough so that the output voltage is helped up while the inductor current ramps up or down to the value corresponding to the new load current. Additionally, the ESR in the output capacitor causes a step in the output voltage equal to the current. Because of the fast transient response and inherent 100% and 0% duty cycle capability provided by the SP6132HHVCU when exposed to output load transients, the output capacitor is typically chosen for ESR, not for capacitance value.

The output capacitor's ESR, combined with the inductor ripple current, is typically the main contributor to output voltage ripple. The maximum allowable ESR required to maintain a specified output voltage ripple can be calculated by:

$$R_{ESR} \leq \frac{\Delta V_{OUT}}{I_{PK-PK}}$$

where:

$\Delta V_{OUT}$  = Peak to Peak Output Voltage Ripple

$I_{PK-PK}$  = Peak to Peak Inductor Ripple Current

The total output ripple is a combination of the ESR and the output capacitance value and can be calculated as follows:

$$\Delta V_{OUT} = \sqrt{\left(\frac{I_{PP}(1-D)}{C_{OUT}F_S}\right)^2 + (I_{PP}R_{ESR})^2}$$

where:

$F_S$  = Switching Frequency

$D$  = Duty Cycle

$C_{OUT}$  = Output Capacitance Value

### Input Capacitor Selection

The input capacitor should be selected for ripple current rating, capacitance and voltage rating. The input capacitor must meet the ripple current requirement imposed by the switching current. In continuous conduction mode, the source current of the high-side MOSFET is approximately a square wave of duty cycle  $V_{OUT}/V_{IN}$ . Most of this current is supplied by the input bypass capacitors. The RMS value of input capacitor current is determined at the maximum output current and under the assumption that the peak to peak inductor ripple current is low; it is given by:

$$I_{CIN(rms)} = I_{OUT(max)} \sqrt{D(1-D)}$$

The worse case occurs when the duty cycle  $D$  is 50% and gives an RMS current value equal to  $I_{OUT}/2$ .

Select input capacitors with adequate ripple current rating to ensure reliable operation.

The power dissipated in the input capacitor is:

$$P_{CIN} = I_{CIN(rms)}^2 R_{ESR(CIN)}$$

This can become a significant part of power losses in a converter and hurt the overall energy transfer efficiency. The input voltage ripple primarily depends on the input capacitor ESR and capacitance. Ignoring the inductor ripple current, the input voltage ripple can be determined by:

$$\Delta V_{IN} = I_{out(max)} R_{ESR(CIN)} + \frac{I_{OUT(MAX)}V_{OUT}(V_{IN} - V_{OUT})}{F_S C_{IN} V_{IN}^2}$$

The capacitor type suitable for the output capacitors can also be used for the input capacitors. However, exercise extra caution when tantalum capacitors are considered. Tantalum capacitors are known for catastrophic failure when exposed to surge current, and input capacitors are prone to such surge current when power supplies are connected “live” to low impedance power sources.

### MOSFET Selection

The losses associated with MOSFETs can be divided into conduction and switching losses. Conduction losses are related to the on resistance of MOSFETs, and increase with the load current. Switching losses occur on each on/off transition when the MOSFETs experience both high current and voltage. Since the bottom MOSFET switches current from/to a paralleled diode (either its own body diode or a Schottky diode), the voltage across the MOSFET is no more than 1V during switching transition. As a result, its switching losses are negligible. The switching losses are difficult to quantify due to all the variables affecting turn on/off time. However, the following equation provides an approximation on the switching losses associated with the top MOSFET driven by SP6132H.

$$P_{SH(max)} = 12C_{rss}V_{IN(max)}I_{OUT(max)}F_S$$

where

$C_{rss}$  = reverse transfer capacitance of the top MOSFET

Switching losses need to be taken into account for high switching frequency, since they are directly proportional to switching frequency. The conduction losses associated with top and bottom MOSFETs are determined by:

$$P_{CH(max)} = R_{DS(ON)}I_{OUT(max)}^2D$$

$$P_{CL(max)} = R_{DS(ON)}I_{OUT(max)}^2(1 - D)$$

where

$P_{CH(max)}$  = conduction losses of the high side MOSFET

$P_{CL(max)}$  = conduction losses of the low side MOSFET

$R_{DS(ON)}$  = drain to source on resistance.

The total power losses of the top MOSFET are the sum of switching and conduction losses. For synchronous buck converters of efficiency over 90%, allow no more than 4% power losses for high or low side MOSFETs. For input voltages of 3.3V and 5V, conduction losses often dominate switching losses. Therefore, lowering the  $R_{DS(ON)}$  of the MOSFETs always improves efficiency even though it gives rise to higher switching losses due to increased  $C_{rss}$ .

Top and bottom MOSFETs experience unequal conduction losses if their on time is unequal. For applications running at large or small duty cycles, it makes sense to use different top and bottom MOSFETs. Alternatively, parallel multiple MOSFETs to conduct large duty factors.

$R_{DS(ON)}$  varies greatly with the gate driver voltage. The MOSFET vendors often specify  $R_{DS(ON)}$  on multiple gate to source voltages ( $V_{GS}$ ), as well as provide typical curve of  $R_{DS(ON)}$  versus  $V_{GS}$ . For 5V input, use the  $R_{DS(ON)}$  specified at 4.5V  $V_{GS}$ . At the time of this publication, vendors, such as Fairchild, Siliconix and International Rectifier, have started to specify  $R_{DS(ON)}$  at  $V_{GS}$  less than 3V. This has provided necessary data for designs in which these MOSFETs are driven with 3.3V and made it possible to use SP6132H in 3.3V *only* applications.

Thermal calculation must be conducted to ensure the MOSFET can handle the maximum load current. The junction temperature of the MOSFET, determined as follows, must stay below the maximum rating.

$$T_{J(max)} = T_{A(max)} + \frac{P_{MOSFET(max)}}{R_{\theta JA}}$$

where

$T_{A(max)}$  = maximum ambient temperature

$P_{MOSFET(max)}$  = maximum power dissipation of the MOSFET

$R_{\theta JA}$  = junction to ambient thermal resistance.

$R_{\theta JA}$  of the device depends greatly on the board layout, as well as device package. Significant

thermal improvement can be achieved in the maximum power dissipation through the proper design of copper mounting pads on the circuit board. For example, in an SO-8 package, placing two 0.04 square inches of copper pad directly under the package, without occupying additional board space, can increase the maximum power from approximately 1 to 1.2W. For DPAK package, enlarging the tap mounting pad to 1 square inch reduces the  $R_{\Theta JA}$  from 96°C/W to 40°C/W.

**Schottky Diode Selection**

When paralleled with the bottom MOSFET, an optional Schottky diode can improve efficiency and reduce noise. Without this Schottky diode, the body diode of the bottom MOSFET conducts the current during the non-overlap time when both MOSFETs are turned off. Unfortunately, the body diode has high forward voltage and reverse recovery problems. The reverse recovery of the body diode causes additional switching noises when the diode turns off. The Schottky diode alleviates these noise sources and additionally improves efficiency thanks to its low forward voltage. The reverse voltage

across the diode is equal to input voltage, and the diode must be able to handle the peak current equal to the maximum load current.

The power dissipation of the Schottky diode is determined by:

$$P_{DIODE} = 2V_F I_{OUT} T_{NOL} F_S$$

where

$T_{NOL}$  = non-overlap time between GH and GL.

$V_F$  = forward voltage of the Schottky diode.

**Loop Compensation Design**

The open loop gain of the whole system can be divided into the gain of the error amplifier, PWM modulator, buck converter output stage, and feedback resistor divider. In order to cross over at the selected frequency FCO, the gain of the error amplifier must compensate for the attenuation caused by the rest of the loop at this frequency.

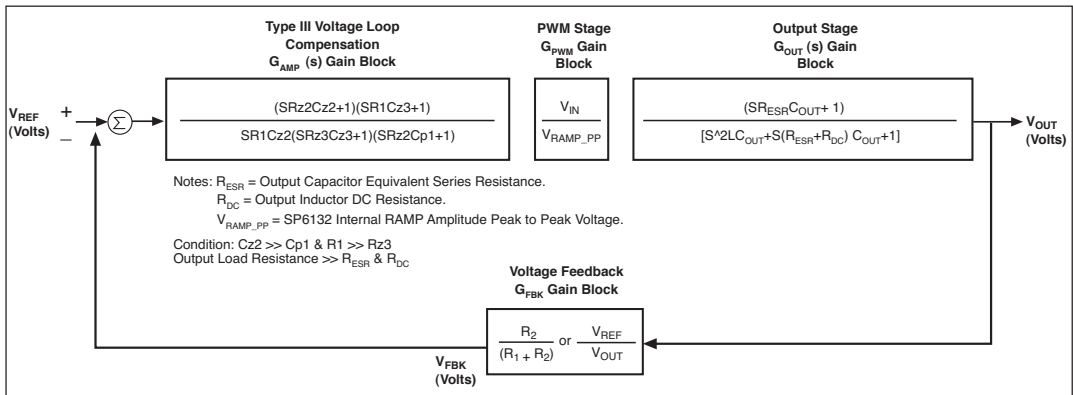

SP6132H Voltage Mode Control Loop with Loop Dynamic

The goal of loop compensation is to manipulate loop frequency response such that its gain crosses over 0db at a slope of -20db/dec. The first step of compensation design is to pick the loop crossover frequency. High crossover frequency is desirable for fast transient response, but often jeopardizes the system stability. Crossover frequency should be higher than the ESR zero but less than 1/5 of the switching frequency. The ESR zero is contributed by the ESR associated with the output capacitors and can be determined by:

$$f_{Z(ESR)} = \frac{1}{2\pi C_{OUT} R_{ESR}}$$

The next step is to calculate the complex conjugate poles contributed by the LC output filter,

$$f_{P(LC)} = \frac{1}{2\pi \sqrt{L} C_{OUT}}$$

When the output capacitors are of a Ceramic Type, the SP6132H requires a Type III compensation circuit to give a phase boost of 180° in order to counteract the effects of an under damped resonance of the output filter at the double pole frequency.

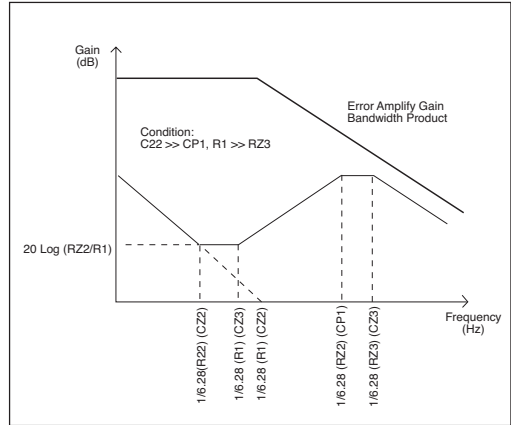

**Bode Plot of Type III Error Amplify Compensation.**

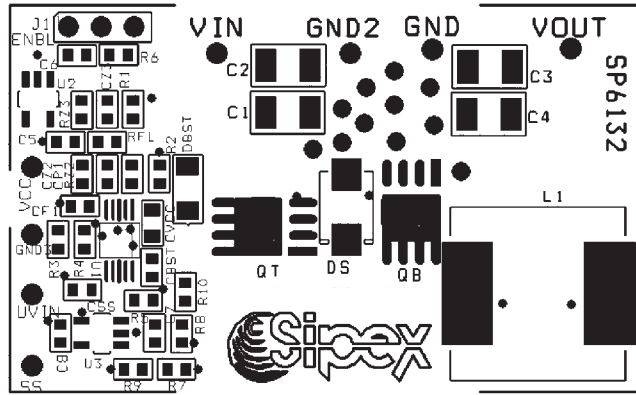

SP6132 Recommended Component Placement

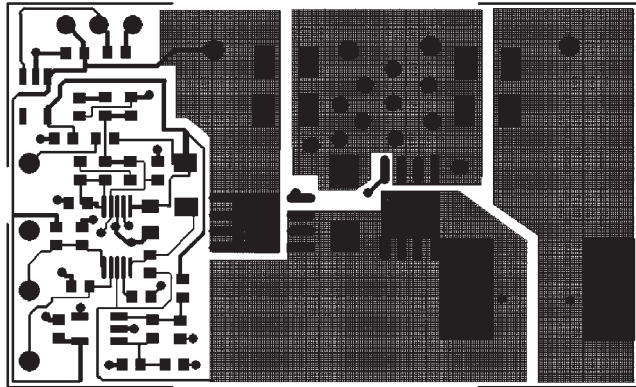

SP6132 Recommended PC Layout Top Side

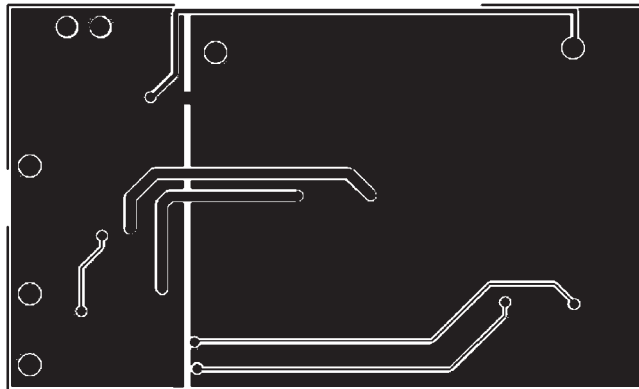

SP6132 Recommended PC Layout Bottom Side

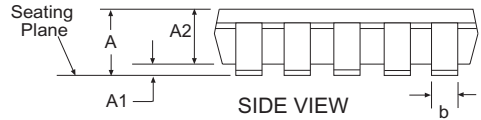
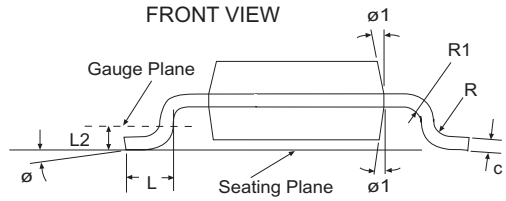
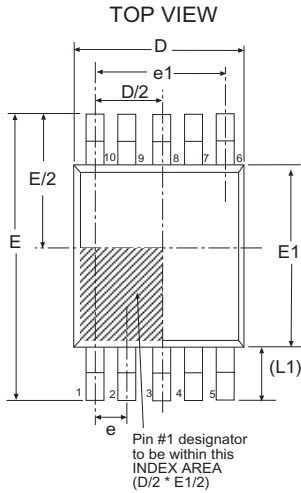

10 Pin MSOP JEDEC MO-187 Variation BA						
SYMBOL	Dimensions in Millimeters: Controlling Dimension			Dimensions in Inches Conversion Factor: 1 Inch = 25.40 mm		
	MIN	NOM	MAX	MIN	NOM	MAX
A1	0.00	-	0.15	0.000	-	0.006
c	0.08	-	0.23	0.004	-	0.009
R	0.07	-	-	0.003	-	-
R1	0.07	-	-	0.003	-	-
$\phi$	0°	-	8°	0°	-	8°
$\phi 1$	5°	-	15°	5°	-	15°
A	-	-	1.10	-	-	0.043
A2	0.75	0.85	0.95	0.030	0.034	0.038
b	0.17	-	0.33	0.007	-	0.013
D	3.00 BSC			0.118 BSC		
E	4.90 BSC			0.193 BSC		
E1	3.00 BSC			0.118 BSC		
e	0.50 BSC			0.020 BSC		
e1	2.00 BSC			0.079 BSC		
L	0.40	0.60	0.80	0.016	0.024	0.032
L1	0.95 REF			0.037 REF		
L2	0.25 BSC			0.010 BSC		
SIPEX Pkg Signoff Date/Rev:				JL Aug09-05 RevA		

---

**ORDERING INFORMATION**

<b>Part Number</b>	<b>Top Mark</b>	<b>Temperature</b>	<b>Package</b>
SP6132HCU .....	SP6132HCU.....	-0°C to +70°C .....	10 Pin MSOP
SP6132HCU/TR .....	SP6132HCU.....	-0°C to +70°C .....	10 Pin MSOP
SP6132HEU .....	SP6132HEU.....	-40°C to +85°C .....	10 Pin MSOP
SP6132HEU/TR .....	SP6132HEU.....	-40°C to +85°C .....	10 Pin MSOP

Available in lead free packaging. To order add "-L" suffix to part number.

Example: SP6132HEU/TR = standard; SP6132HEU-L/TR = lead free

/TR = Tape and Reel

Pack quantity is 2500 for MSOP.



Solved By Sipex™



**Sipex Corporation**

**Headquarters and  
Sales Office**  
233 South Hillview Drive  
Milpitas, CA 95035  
TEL: (408) 934-7500  
FAX: (408) 935-7600







Sipex Corporation reserves the right to make changes to any products described herein. Sipex does not assume any liability arising out of the application or use of any product or circuit described herein; neither does it convey any license under its patent rights nor the rights of others.

## Looking for pricing, stock, or lifecycle information?

Click below to explore more details on WIN SOURCE:

-  [View SP6132HEU-L/TR on WIN SOURCE](#)
-  [Exar Corporation](#) Information

## Optimize Your Supply Chain with WIN SOURCE Solutions

-  Global Sourcing Solution
-  Obsolete Management
-  Cost Control Management
-  Shortage Management
-  Alternative Solution
-  Excess Inventory Management