



THE DATASHEET OF SPA06N80C3



CoolMOS™ Power Transistor

Features

- New revolutionary high voltage technology
- Extreme dv/dt rated
- High peak current capability
- Qualified according to JEDEC¹⁾ for target applications
- Pb-free lead plating; RoHS compliant
- Ultra low gate charge
- Ultra low effective capacitances
- Fully isolated package (2500 VAC; 1 minute)

CoolMOS™ 800V designed for:

- Industrial application with high DC bulk voltage
- Switching Application (i.e. active clamp forward)

Product Summary

V_{DS}	800	V
$R_{DS(on)max}$ @ $T_j = 25^\circ\text{C}$	0.9	Ω
$Q_{g,typ}$	31	nC

PG-TO220-3 (fully isolated)



Type	Package	Marking
SPA06N80C3	PG-TO220-3	06N80C3

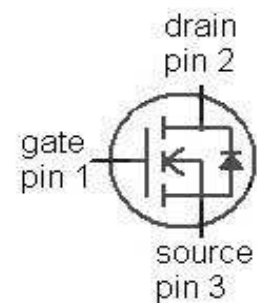

Maximum ratings, at $T_j=25^\circ\text{C}$, unless otherwise specified

Parameter	Symbol	Conditions	Value	Unit
Continuous drain current ²⁾	I_D	$T_C=25^\circ\text{C}$	6	A
		$T_C=100^\circ\text{C}$	3.8	
Pulsed drain current ³⁾	$I_{D,pulse}$	$T_C=25^\circ\text{C}$	18	
Avalanche energy, single pulse	E_{AS}	$I_D=1.2\text{ A}, V_{DD}=50\text{ V}$	230	mJ
Avalanche energy, repetitive t_{AR} ^{3),4)}	E_{AR}	$I_D=6\text{ A}, V_{DD}=50\text{ V}$	0.2	
Avalanche current, repetitive t_{AR} ^{3),4)}	I_{AR}		6	A
MOSFET dv/dt ruggedness	dv/dt	$V_{DS}=0\dots640\text{ V}$	50	V/ns
Gate source voltage	V_{GS}	static	± 20	V
		AC ($f>1\text{ Hz}$)	± 30	
Power dissipation	P_{tot}	$T_C=25^\circ\text{C}$	39	W
Operating and storage temperature	T_j, T_{stg}		-55 ... 150	$^\circ\text{C}$
Mounting torque		M2.5 screws	50	Ncm

Maximum ratings, at $T_j=25\text{ °C}$, unless otherwise specified

Parameter	Symbol	Conditions	Value	Unit
Continuous diode forward current	I_S	$T_C=25\text{ °C}$	6	A
Diode pulse current ³⁾	$I_{S,pulse}$		18	
Reverse diode dv/dt ⁵⁾	dv/dt		4	V/ns

Parameter	Symbol	Conditions	Values			Unit
			min.	typ.	max.	

Thermal characteristics

Thermal resistance, junction - case	R_{thJC}		-	-	3.9	K/W
Thermal resistance, junction - ambient	R_{thJA}	leaded	-	-	80	
Soldering temperature, wave soldering only allowed at leads	T_{sold}	1.6 mm (0.063 in.) from case for 10s	-	-	260	°C

Electrical characteristics, at $T_j=25\text{ °C}$, unless otherwise specified

Static characteristics

Drain-source breakdown voltage	$V_{(BR)DSS}$	$V_{GS}=0\text{ V}$, $I_D=250\text{ }\mu\text{A}$	800	-	-	V
Avalanche breakdown voltage	$V_{(BR)DS}$	$V_{GS}=0\text{ V}$, $I_D=6\text{ A}$	-	870	-	
Gate threshold voltage	$V_{GS(th)}$	$V_{DS}=V_{GS}$, $I_D=0.25\text{ mA}$	2.1	3	3.9	
Zero gate voltage drain current	I_{DSS}	$V_{DS}=800\text{ V}$, $V_{GS}=0\text{ V}$, $T_j=25\text{ °C}$	-	-	10	μA
		$V_{DS}=800\text{ V}$, $V_{GS}=0\text{ V}$, $T_j=150\text{ °C}$	-	50	-	
Gate-source leakage current	I_{GSS}	$V_{GS}=20\text{ V}$, $V_{DS}=0\text{ V}$	-	-	100	nA
Drain-source on-state resistance	$R_{DS(on)}$	$V_{GS}=10\text{ V}$, $I_D=3.8\text{ A}$, $T_j=25\text{ °C}$	-	0.78	0.9	Ω
		$V_{GS}=10\text{ V}$, $I_D=3.8\text{ A}$, $T_j=150\text{ °C}$	-	2.1	-	
Gate resistance	R_G	$f=1\text{ MHz}$, open drain	-	1.2	-	Ω

Parameter	Symbol	Conditions	Values			Unit
			min.	typ.	max.	

Dynamic characteristics

Input capacitance	C_{iss}	$V_{GS}=0\text{ V}, V_{DS}=100\text{ V},$	-	785	-	pF
Output capacitance	C_{oss}	$f=1\text{ MHz}$	-	33	-	
Effective output capacitance, energy related ⁶⁾	$C_{o(er)}$	$V_{GS}=0\text{ V}, V_{DS}=0\text{ V}$ to 480 V	-	26	-	
Effective output capacitance, time related ⁷⁾	$C_{o(tr)}$		-	69	-	
Turn-on delay time	$t_{d(on)}$	$V_{DD}=400\text{ V},$ $V_{GS}=0/10\text{ V}, I_D=6\text{ A},$ $R_G=15\text{ }\Omega, T_j=25\text{ }^\circ\text{C}$	-	25	-	ns
Rise time	t_r		-	15	-	
Turn-off delay time	$t_{d(off)}$		-	72	-	
Fall time	t_f		-	8	-	

Gate Charge Characteristics

Gate to source charge	Q_{gs}	$V_{DD}=640\text{ V}, I_D=6\text{ A},$ $V_{GS}=0\text{ to }10\text{ V}$	-	4	-	nC
Gate to drain charge	Q_{gd}		-	15	-	
Gate charge total	Q_g		-	31	41	
Gate plateau voltage	$V_{plateau}$		-	5.5	-	V

Reverse Diode

Diode forward voltage	V_{SD}	$V_{GS}=0\text{ V}, I_F=I_S=6\text{ A},$ $T_j=25\text{ }^\circ\text{C}$	-	1	1.2	V
Reverse recovery time	t_{rr}	$V_R=400\text{ V}, I_F=I_S=6\text{ A},$ $di_F/dt=100\text{ A}/\mu\text{s}$	-	520	-	ns
Reverse recovery charge	Q_{rr}		-	5	-	μC
Peak reverse recovery current	I_{rrm}		-	18	-	A

¹⁾ J-STD20 and JESD22

²⁾ Limited only by maximum temperature

³⁾ Pulse width t_p limited by $T_{j,max}$
⁴⁾ Repetitive avalanche causes additional power losses that can be calculated as $P_{AV}=E_{AR} \cdot f$.

⁵⁾ $I_{SD}=I_D, di/dt=400\text{ A}/\mu\text{s}, V_{DClink}=400\text{ V}, V_{peak}<V_{(BR)DSS}, T_j<T_{j,max}$, identical low side and high side switch

⁶⁾ $C_{o(er)}$ is a fixed capacitance that gives the same stored energy as C_{oss} while V_{DS} is rising from 0 to 80% V_{DSS} .

⁷⁾ $C_{o(tr)}$ is a fixed capacitance that gives the same charging time as C_{oss} while V_{DS} is rising from 0 to 80% V_{DSS} .

1 Power dissipation

$$P_{tot} = f(T_C)$$

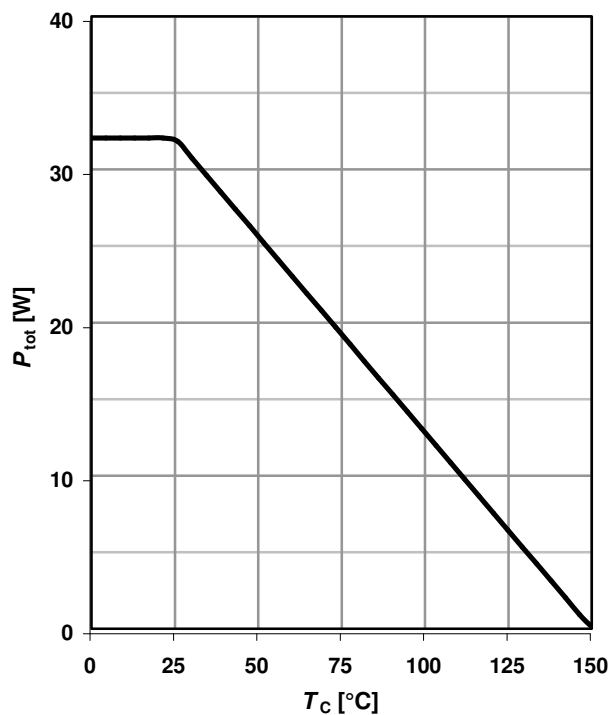

2 Safe operating area

$$I_D = f(V_{DS}); T_C = 25^\circ\text{C}; D = 0$$

parameter: t_p

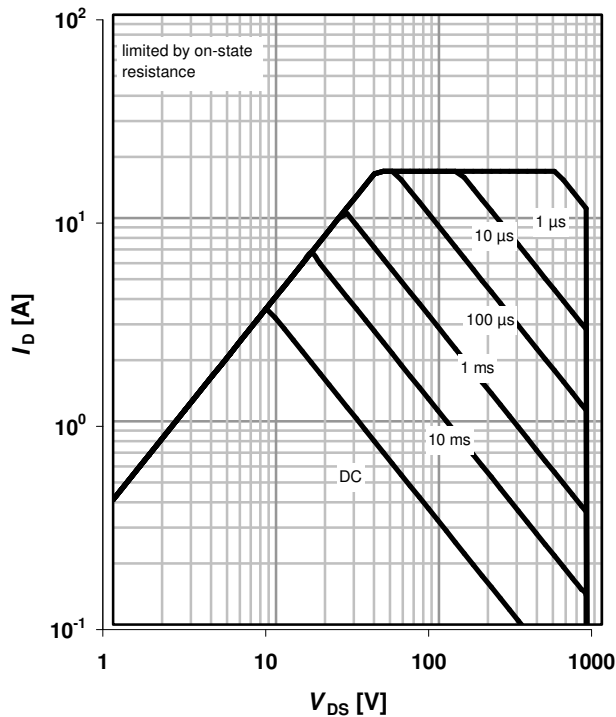

3 Max. transient thermal impedance

$$Z_{thJC} = f(t_p)$$

parameter: $D = t_p / T$

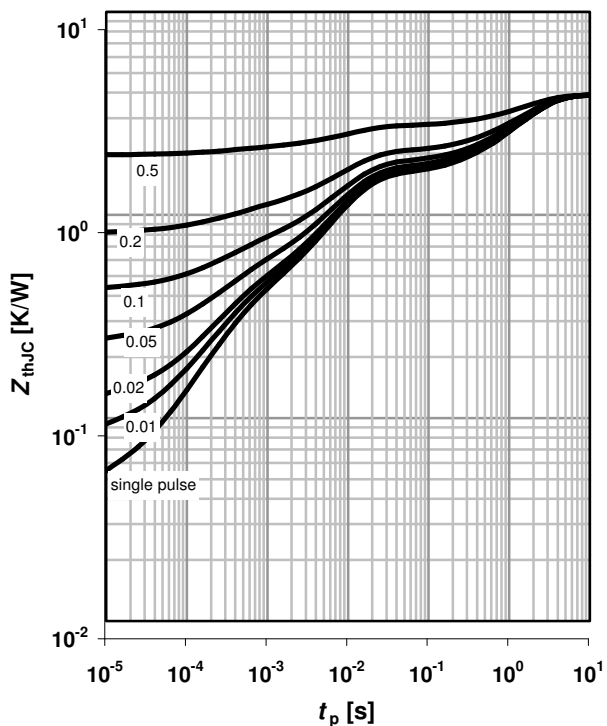

4 Typ. output characteristics

$$I_D = f(V_{DS}); T_j = 25^\circ\text{C}; t_p = 10 \mu\text{s}$$

parameter: V_{GS}

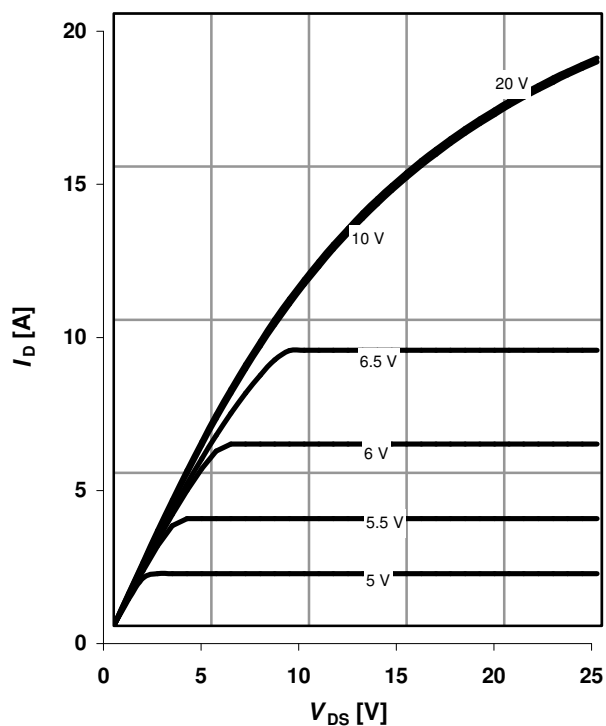

5 Typ. output characteristics

$I_D=f(V_{DS}); T_j=150\text{ °C}; t_p=10\text{ }\mu\text{s}$

parameter: V_{GS}

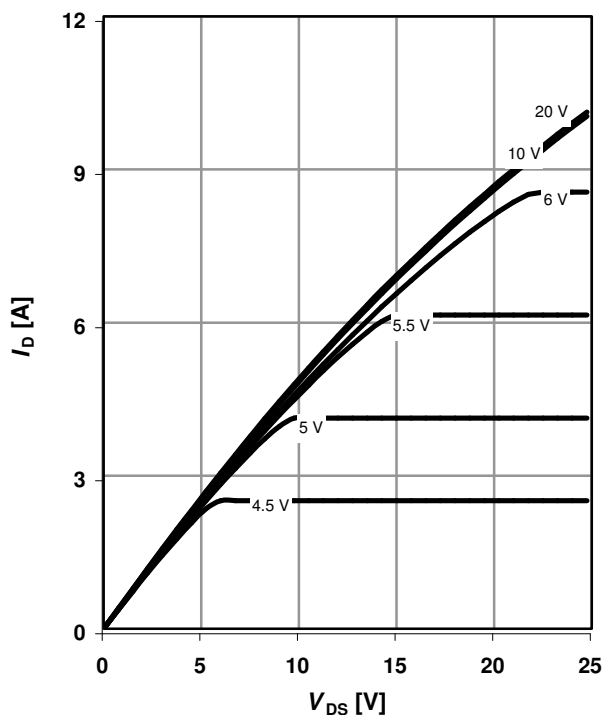

6 Typ. drain-source on-state resistance

$R_{DS(on)}=f(I_D); T_j=150\text{ °C}$

parameter: V_{GS}

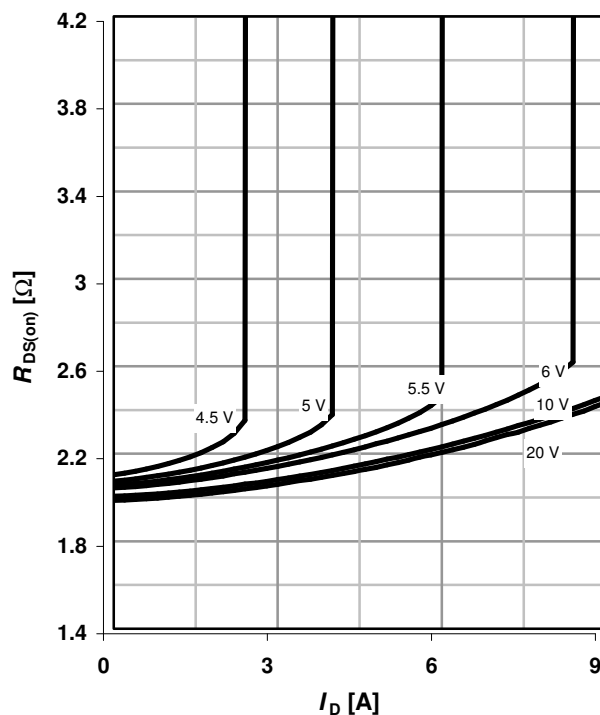

7 Drain-source on-state resistance

$R_{DS(on)}=f(T_j); I_D=3.8\text{ A}; V_{GS}=10\text{ V}$

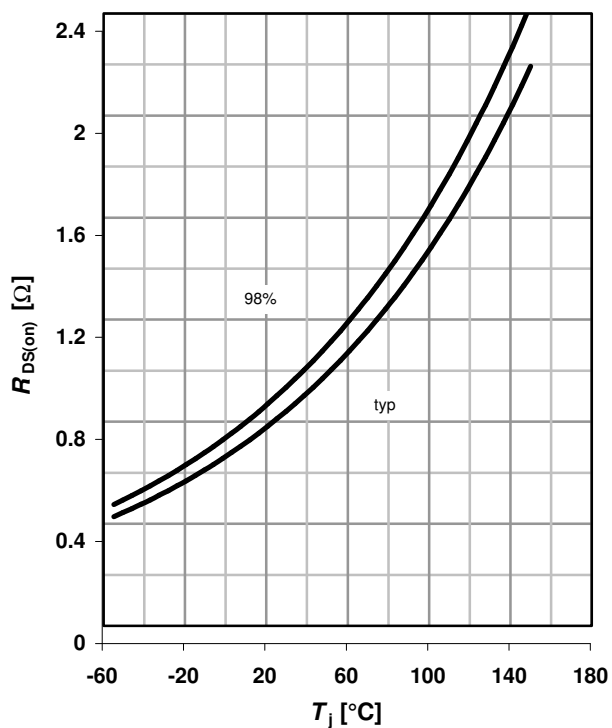

8 Typ. transfer characteristics

$I_D=f(V_{GS}); |V_{DS}|>2|I_D|R_{DS(on)max}; t_p=10\text{ }\mu\text{s}$

parameter: T_j

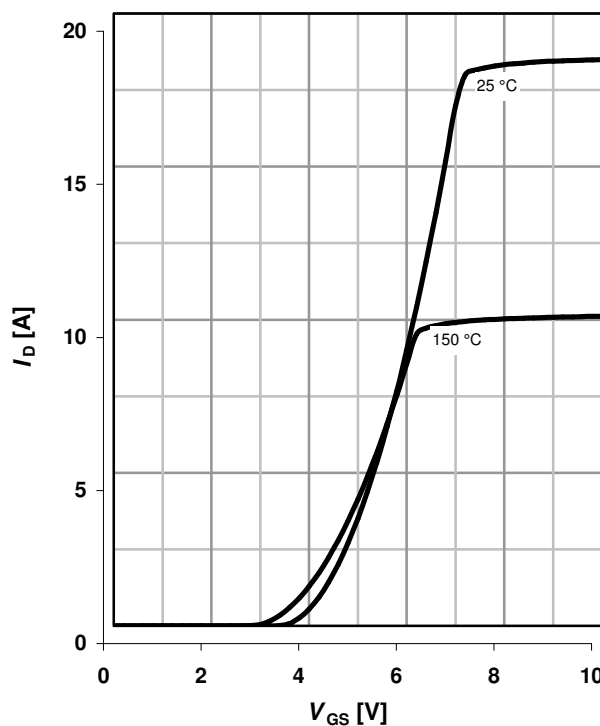

9 Typ. gate charge

$V_{GS}=f(Q_{gate}); I_D=6\text{ A pulsed}$

parameter: V_{DD}

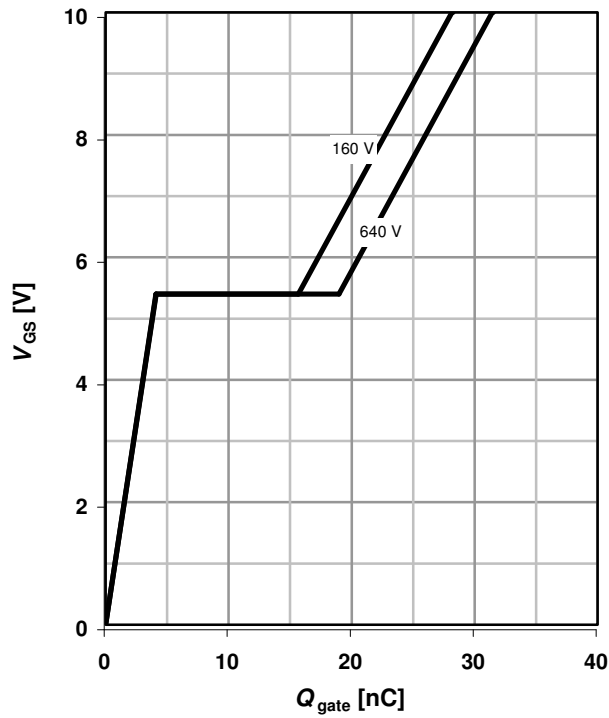

10 Forward characteristics of reverse diode

$I_F=f(V_{SD}); t_p=10\ \mu\text{s}$

parameter: T_j

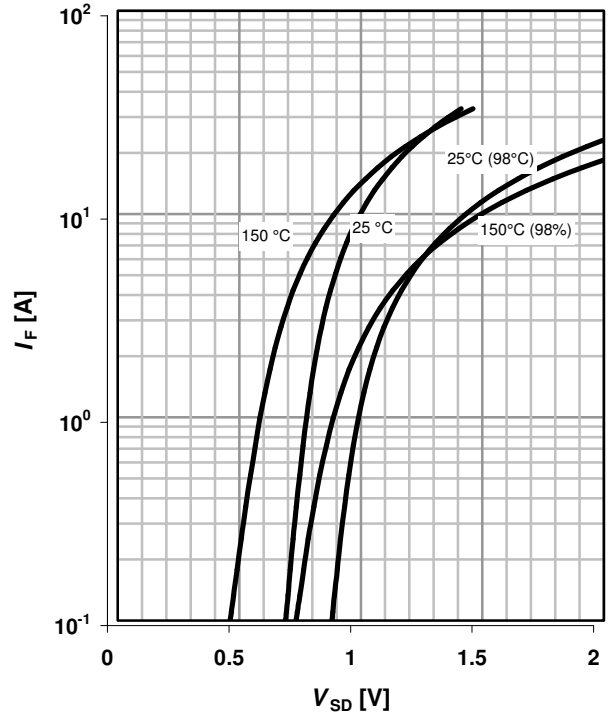

11 Avalanche energy

$E_{AS}=f(T_j); I_D=1.2\text{ A}; V_{DD}=50\text{ V}$

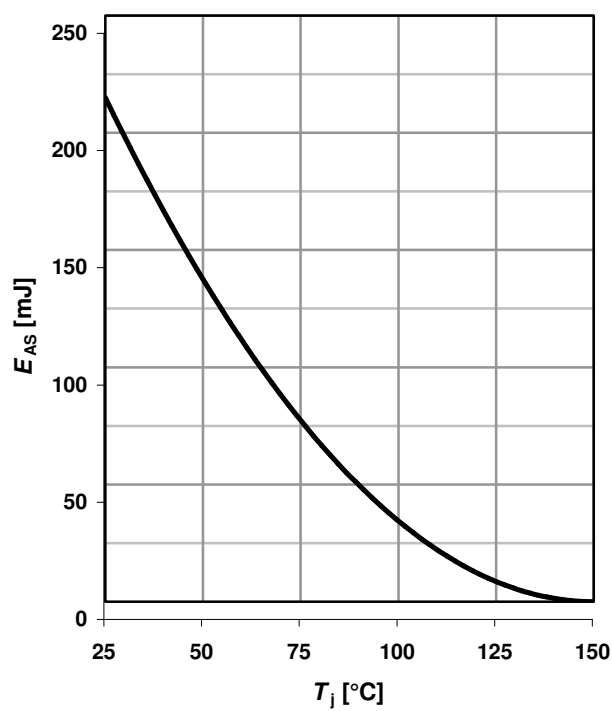

12 Drain-source breakdown voltage

$V_{BR(DSS)}=f(T_j); I_D=0.25\text{ mA}$

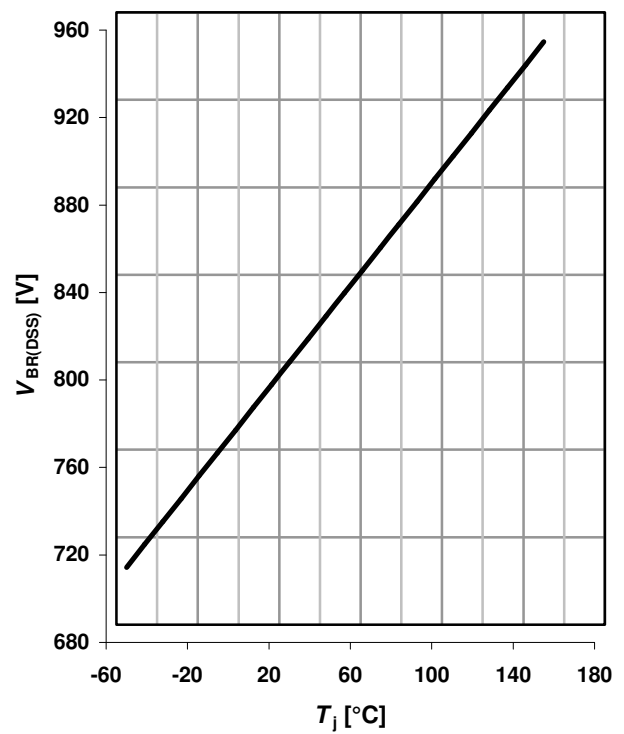

13 Typ. capacitances

$C=f(V_{DS}); V_{GS}=0\text{ V}; f=1\text{ MHz}$

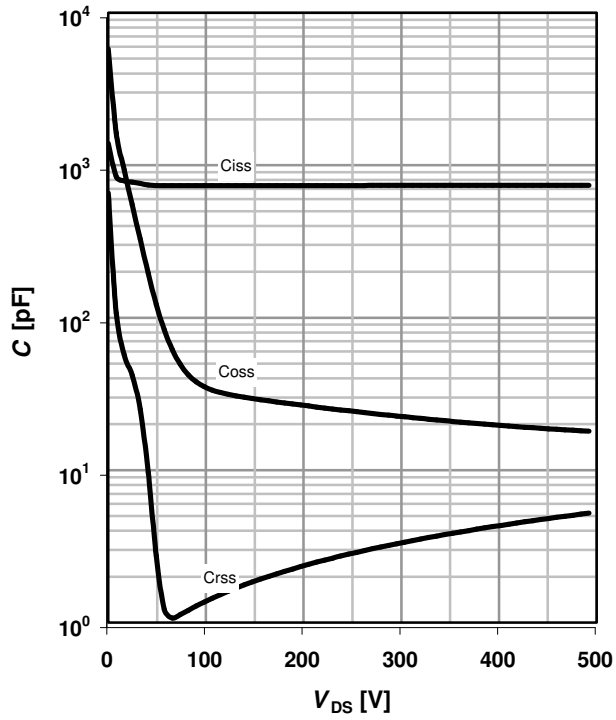

14 Typ. Coss stored energy

$E_{oss}=f(V_{DS})$

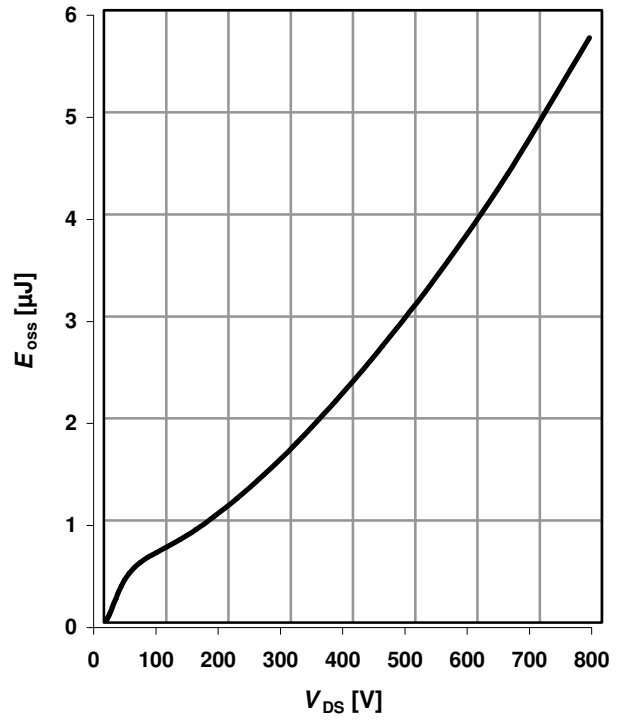

Definition of diode switching characteristics

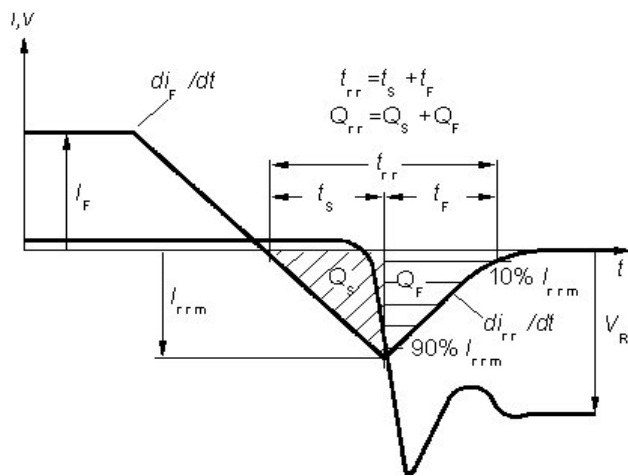

Outline PG-TO220 FullPAK

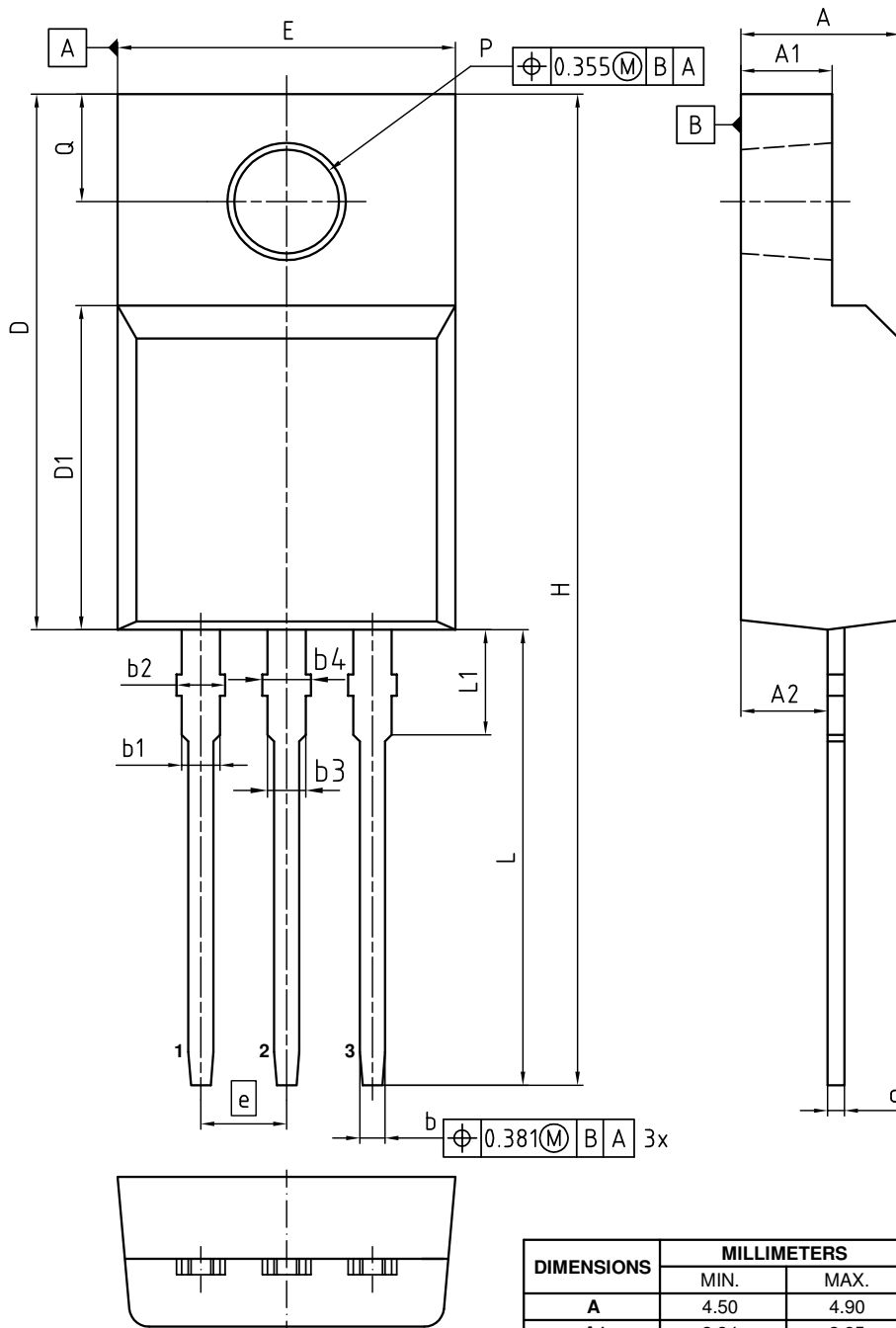

NOTES:
 ALL DIMENSIONS REFER TO JEDEC STANDARD TO-281
 AND DOES NOT INCLUDE MOLD FLASH, PROTRUSIONS
 OR GATE BURRS
 GATE BURRS ARE LESS THAN 0.5 mm

DIMENSIONS	MILLIMETERS	
	MIN.	MAX.
A	4.50	4.90
A1	2.34	2.85
A2	2.42	2.86
b	0.65	0.90
b1	0.95	1.38
b2	0.95	1.51
b3	0.65	1.38
b4	0.65	1.51
c	0.40	0.63
D	15.67	16.15
D1	8.97	9.83
E	10.00	10.65
e	2.54	
H	28.70	29.75
L	12.78	13.75
L1	2.83	3.45
øP	3.00	3.30
Q	3.15	3.50

DOCUMENT NO. Z8B00003319
REVISION 07
SCALE 5:1 0 1 2 3 4 5mm
EUROPEAN PROJECTION
ISSUE DATE 27.01.2017

800V CoolMOS™ C3 Power Transistor

SPA06N80C3

Revision History

SPA06N80C3

Revision: 2018-02-27, Rev. 2.92

Previous Revision

Revision	Date	Subjects (major changes since last revision)
2.92	2018-02-27	Outline PG-TO-220 FullPAK update

Trademarks of Infineon Technologies AG

AURIX™, C166™, CanPAK™, CIPOS™, CoolGaN™, CoolMOS™, CoolSET™, CoolSiC™, CORECONTROL™, CROSSAVE™, DAVE™, DI-POL™, DrBlade™, EasyPIM™, EconoBRIDGE™, EconoDUAL™, EconoPACK™, EconoPIM™, EiceDRIVER™, eupec™, FCOS™, HITFET™, HybridPACK™, Infineon™, ISOFACE™, IsoPACK™, i-Wafer™, MIPAQ™, ModSTACK™, my-d™, NovalithIC™, OmniTune™, OPTIGA™, OptiMOS™, ORIGA™, POWERCODE™, PRIMARION™, PrimePACK™, PrimeSTACK™, PROFET™, PRO-SIL™, RASIC™, REAL3™, ReverSave™, SatRIC™, SIEGET™, SIPMOS™, SmartLEWIS™, SOLID FLASH™, SPOC™, TEMPFET™, thinQ!™, TRENCHSTOP™, TriCore™.

Trademarks updated August 2015

Other Trademarks

All referenced product or service names and trademarks are the property of their respective owners.

We Listen to Your Comments

Any information within this document that you feel is wrong, unclear or missing at all? Your feedback will help us to continuously improve the quality of this document. Please send your proposal (including a reference to this document) to:

erratum@infineon.com

Published by

Infineon Technologies AG

81726 München, Germany

© 2018 Infineon Technologies AG

All Rights Reserved.

Legal Disclaimer

The information given in this document shall in no event be regarded as a guarantee of conditions or characteristics ("Beschaffheitsgarantie").

With respect to any examples, hints or any typical values stated herein and/or any information regarding the application of the product, Infineon Technologies hereby disclaims any and all warranties and liabilities of any kind, including without limitation warranties of non-infringement of intellectual property rights of any third party.

In addition, any information given in this document is subject to customer's compliance with its obligations stated in this document and any applicable legal requirements, norms and standards concerning customer's products and any use of the product of Infineon Technologies in customer's applications.

The data contained in this document is exclusively intended for technically trained staff. It is the responsibility of customer's technical departments to evaluate the suitability of the product for the intended application and the completeness of the product information given in this document with respect to such application.

Information

For further information on technology, delivery terms and conditions and prices please contact your nearest Infineon Technologies Office (www.infineon.com).



Warnings

Due to technical requirements, components may contain dangerous substances. For information on the types in question, please contact the nearest Infineon Technologies Office.

The Infineon Technologies component described in this Data Sheet may be used in life-support devices or systems and/or automotive, aviation and aerospace applications or systems only with the express written approval of Infineon Technologies, if a failure of such components can reasonably be expected to cause the failure of that life-support, automotive, aviation and aerospace device or system or to affect the safety or effectiveness of that device or system. Life support devices or systems are intended to be implanted in the human body or to support and/or maintain and sustain and/or protect human life. If they fail, it is reasonable to assume that the health of the user or other persons may be endangered.

Looking for pricing, stock, or lifecycle information?

Click below to explore more details on WIN SOURCE:

-  [View SPA06N80C3 on WIN SOURCE](#)
-  [Infineon Technologies Information](#)

Optimize Your Supply Chain with WIN SOURCE Solutions

-  Global Sourcing Solution
-  Obsolete Management
-  Cost Control Management
-  Shortage Management
-  Alternative Solution
-  Excess Inventory Management