



**THE DATASHEET OF
74LCX2244MTCX**





Is Now Part of



ON Semiconductor®

To learn more about ON Semiconductor, please visit our website at
www.onsemi.com

Please note: As part of the Fairchild Semiconductor integration, some of the Fairchild orderable part numbers will need to change in order to meet ON Semiconductor's system requirements. Since the ON Semiconductor product management systems do not have the ability to manage part nomenclature that utilizes an underscore (_), the underscore (_) in the Fairchild part numbers will be changed to a dash (-). This document may contain device numbers with an underscore (_). Please check the ON Semiconductor website to verify the updated device numbers. The most current and up-to-date ordering information can be found at www.onsemi.com. Please email any questions regarding the system integration to Fairchild_questions@onsemi.com.

ON Semiconductor and the ON Semiconductor logo are trademarks of Semiconductor Components Industries, LLC dba ON Semiconductor or its subsidiaries in the United States and/or other countries. ON Semiconductor owns the rights to a number of patents, trademarks, copyrights, trade secrets, and other intellectual property. A listing of ON Semiconductor's product/patent coverage may be accessed at www.onsemi.com/site/pdf/Patent-Marking.pdf. ON Semiconductor reserves the right to make changes without further notice to any products herein. ON Semiconductor makes no warranty, representation or guarantee regarding the suitability of its products for any particular purpose, nor does ON Semiconductor assume any liability arising out of the application or use of any product or circuit, and specifically disclaims any and all liability, including without limitation special, consequential or incidental damages. Buyer is responsible for its products and applications using ON Semiconductor products, including compliance with all laws, regulations and safety requirements or standards, regardless of any support or applications information provided by ON Semiconductor. "Typical" parameters which may be provided in ON Semiconductor data sheets and/or specifications can and do vary in different applications and actual performance may vary over time. All operating parameters, including "Typicals" must be validated for each customer application by customer's technical experts. ON Semiconductor does not convey any license under its patent rights nor the rights of others. ON Semiconductor products are not designed, intended, or authorized for use as a critical component in life support systems or any FDA Class 3 medical devices or medical devices with a same or similar classification in a foreign jurisdiction or any devices intended for implantation in the human body. Should Buyer purchase or use ON Semiconductor products for any such unintended or unauthorized application, Buyer shall indemnify and hold ON Semiconductor and its officers, employees, subsidiaries, affiliates, and distributors harmless against all claims, costs, damages, and expenses, and reasonable attorney fees arising out of, directly or indirectly, any claim of personal injury or death associated with such unintended or unauthorized use, even if such claim alleges that ON Semiconductor was negligent regarding the design or manufacture of the part. ON Semiconductor is an Equal Opportunity/Affirmative Action Employer. This literature is subject to all applicable copyright laws and is not for resale in any manner.

74LCX2244

Low Voltage Buffer/Line Driver with 5V Tolerant Inputs and Outputs with 26Ω Series Resistors in the Outputs

General Description

The LCX2244 contains eight non-inverting buffers with 3-STATE outputs. The device may be employed as a memory address driver, clock driver and bus-oriented transmitter/receiver. The LCX2244 is designed for low voltage (2.5V or 3.3V) V_{CC} applications with capability of interfacing to a 5V signal environment. The 26Ω series resistors help reduce output overshoot and undershoot.

The LCX2244 is fabricated with an advanced CMOS technology to achieve high speed operation while maintaining CMOS low power dissipation.

Features

- 5V tolerant inputs and outputs
- 2.3V to 3.6V V_{CC} specifications provided
- 7.5 ns t_{PD} max ($V_{CC} = 3.3V$) 10 μA I_{CC} max
- Power down high impedance inputs and outputs
- 26Ω-series resistors in the outputs
- Supports live insertion/withdrawal (Note 1)
- ± 12 mA output drive ($V_{CC} = 3.0V$)
- Implements patented noise/EMI reduction circuitry
- Latch-up performance exceeds 500 mA
- ESD performance:
 - Human body model > 2000V
 - Machine model > 200V
- Leadless DQFN package

Note 1: To ensure the high-impedance state during power up or down, \overline{OE} should be tied to V_{CC} through a pull-up resistor: the minimum value or the resistor is determined by the current-sourcing capability of the driver.

Ordering Code:

| Order Number | Package Number | Package Description |
|------------------------------|--------------------------|---|
| 74LCX2244WM | M20B | 20-Lead Small Outline Integrated Circuit (SOIC), JEDEC MS-013, 0.300" Wide |
| 74LCX2244SJ | M20D | 20-Lead Small Outline Package (SOP), EIAJ TYPE II, 5.3mm Wide |
| 74LCX2244BQ (Preliminary) | MLP020B (Preliminary) | 20-Terminal Depopulated Quad Very-Thin Flat Pack No Leads (DQFN), JEDEC MO-241, 2.5 x 4.5mm |
| 74LCX2244MSA | MSA20 | 20-Lead Shrink Small Outline Package (SSOP), JEDEC MO-150, 5.3mm Wide |
| 74LCX2244MTC | MTC20 | 20-Lead Thin Shrink Small Outline Package (TSSOP), JEDEC MO-153, 4.4mm Wide |

Devices also available in Tape and Reel. Specify by appending suffix letter "X" to the ordering code.

Logic Symbol

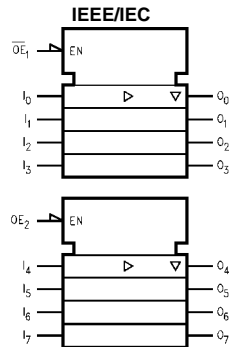

Connection Diagrams

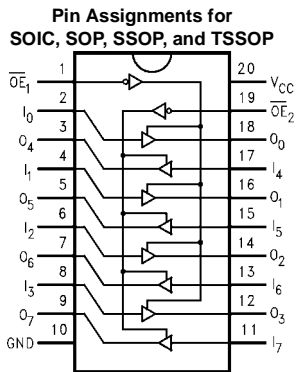

Pad Assignment for DQFN

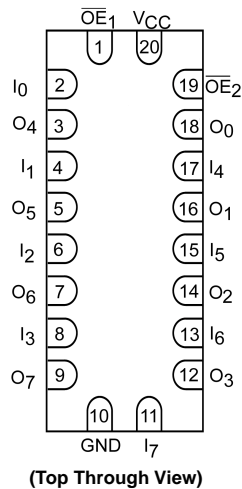

Pin Descriptions

| Pin Names | Description |
|------------------------------------|------------------------------|
| $\overline{OE}_1, \overline{OE}_2$ | 3-STATE Output Enable Inputs |
| I_0-I_7 | Inputs |
| O_0-O_7 | Outputs |

Truth Tables

| Inputs | | Outputs |
|-------------------|-------|-----------------------|
| \overline{OE}_1 | I_n | (Pins 12, 14, 16, 18) |
| L | L | L |
| L | H | H |
| H | X | Z |

| Inputs | | Outputs |
|-------------------|-------|-------------------|
| \overline{OE}_2 | I_n | (Pins 3, 5, 7, 9) |
| L | L | L |
| L | H | H |
| H | X | Z |

H = HIGH Voltage Level
 X = Immaterial
 L = LOW Voltage Level
 Z = High Impedance

| Absolute Maximum Ratings ^(Note 2) | | | | |
|--|----------------------------------|---|---|-------|
| Symbol | Parameter | Value | Conditions | Units |
| V _{CC} | Supply Voltage | -0.5 to +7.0 | | V |
| V _I | DC Input Voltage | -0.5 to +7.0 | | V |
| V _O | DC Output Voltage | -0.5 to +7.0 -0.5 to V _{CC} + 0.5 | Output in 3-STATE Output in HIGH or LOW State (Note 3) | V |
| I _{IK} | DC Input Diode Current | -50 | V _I < GND | mA |
| I _{OK} | DC Output Diode Current | -50 +50 | V _O < GND V _O > V _{CC} | mA |
| I _O | DC Output Source/Sink Current | ±50 | | mA |
| I _{CC} | DC Supply Current per Supply Pin | ±100 | | mA |
| I _{GND} | DC Ground Current per Ground Pin | ±100 | | mA |
| T _{STG} | Storage Temperature | -65 to +150 | | °C |

| Recommended Operating Conditions ^(Note 4) | | | | | |
|--|--|-------------------------------|------|-----------------|----|
| Symbol | Parameter | Min | Max | Units | |
| V _{CC} | Supply Voltage | Operating | 2.0 | 3.6 | V |
| | | Data Retention | 1.5 | 3.6 | |
| V _I | Input Voltage | 0.0 | 5.5 | V | |
| V _O | Output Voltage | HIGH or LOW State | 0.0 | V _{CC} | V |
| | | 3-STATE | 0.0 | 5.5 | |
| I _{OH} /I _{OL} | Output Current | V _{CC} = 3.0V – 3.6V | | ±12.0 | mA |
| | | V _{CC} = 2.7V – 3.0V | | ±8.0 | |
| | | V _{CC} = 2.3V – 2.7V | | ±4.0 | |
| T _A | Free-Air Operating Temperature | -40.0 | 85.0 | °C | |
| Δt/ΔV | Input Edge Rate, V _{IN} = 0.8V – 2.0V, V _{CC} = 3.0V | 0.0 | 10.0 | ns/V | |

Note 2: The Absolute Maximum Ratings are those values beyond which the safety of the device cannot be guaranteed. The device should not be operated at these limits. The parametric values defined in the Electrical Characteristics tables are not guaranteed at the Absolute Maximum Ratings. The "Recommended Operating Conditions" table will define the conditions for actual device operation.

Note 3: I_O Absolute Maximum Rating must be observed.

Note 4: Unused inputs must be held HIGH or LOW. They may not float.

DC Electrical Characteristics

| Symbol | Parameter | Conditions | V _{CC} (V) | T _A = -40°C to +85°C | | Units |
|-----------------|---------------------------|--|------------------------|---------------------------------|------------|-------|
| | | | | Min | Max | |
| V _{IH} | HIGH Level Input Voltage | | 2.3 – 2.7 2.7 – 3.6 | 1.7 2.0 | | V |
| V _{IL} | LOW Level Input Voltage | | 2.3 – 2.7 2.7 – 3.6 | | 0.7 0.8 | V |
| V _{OH} | HIGH Level Output Voltage | I _{OH} = -100 μA | 2.3 – 3.6 | V _{CC} - 0.2 | | V |
| | | I _{OH} = -4 mA | 2.3 | 1.8 | | |
| | | I _{OH} = -4 mA | 2.7 | 2.2 | | |
| | | I _{OH} = -6 mA | 3.0 | 2.4 | | |
| | | I _{OH} = -8 mA | 2.7 | 2.0 | | |
| | | I _{OH} = -12 mA | 3.0 | 2.0 | | |
| V _{OL} | LOW Level Output Voltage | I _{OL} = 100 μA | 2.3 – 3.6 | | 0.2 | V |
| | | I _{OL} = 4 mA | 2.3 | | 0.6 | |
| | | I _{OL} = 4 mA | 2.7 | | 0.4 | |
| | | I _{OL} = 6 mA | 3.0 | | 0.55 | |
| | | I _{OL} = 8 mA | 2.7 | | 0.6 | |
| | | I _{OL} = 12 mA | 3.0 | | 0.8 | |
| I _I | Input Leakage Current | 0 ≤ V _I ≤ 5.5V | 2.3 – 3.6 | | ±5.0 | μA |
| I _{OZ} | 3-STATE Output Leakage | 0 ≤ V _O ≤ 5.5V V _I = V _{IH} or V _{IL} | 2.3 – 3.6 | | ±5.0 | μA |

| DC Electrical Characteristics (Continued) | | | | | | | | |
|---|---|---|------------------------|---------------------------------|-------|------------------------------|------|-------|
| Symbol | Parameter | Conditions | V _{CC} (V) | T _A = -40°C to +85°C | | Units | | |
| | | | | Min | Max | | | |
| I _{OFF} | Power-Off Leakage Current | V _I or V _O = 5.5V | 0.0 | | 10.0 | μA | | |
| I _{CC} | Quiescent Supply Current | V _I = V _{CC} or GND | 2.3 – 3.6 | | 10.0 | μA | | |
| | | 3.6V ≤ V _I , V _O ≤ 5.5V (Note 5) | 2.3 – 3.6 | | ±10.0 | | | |
| ΔI _{CC} | Increase in I _{CC} per Input | V _{IH} = V _{CC} - 0.6V | 2.3 – 3.6 | | 500 | μA | | |
| Note 5: Outputs disabled or 3-STATE only. | | | | | | | | |
| AC Electrical Characteristics | | | | | | | | |
| Symbol | Parameter | T _A = -40°C to +85°C, R _L = 500Ω | | | | | | Units |
| | | V _{CC} = 3.3V ± 0.3V | | V _{CC} = 2.7V | | V _{CC} = 2.5 ± 0.2V | | |
| | | C _L = 50pF | | C _L = 50pF | | C _L = 30pF | | |
| | | Min | Max | Min | Max | Min | Max | |
| t _{PHL} | Propagation Delay | 1.5 | 7.5 | 1.5 | 8.5 | 1.5 | 9.0 | ns |
| t _{PLH} | Data to Output | 1.5 | 7.5 | 1.5 | 8.5 | 1.5 | 9.0 | |
| t _{PZL} | Output Enable Time | 1.5 | 9.0 | 1.5 | 10.0 | 1.5 | 10.5 | ns |
| t _{PZH} | | 1.5 | 9.0 | 1.5 | 10.0 | 1.5 | 10.5 | |
| t _{PLZ} | Output Disable Time | 1.5 | 7.0 | 1.5 | 8.0 | 1.5 | 8.4 | ns |
| t _{PHZ} | | 1.5 | 7.0 | 1.5 | 8.0 | 1.5 | 8.4 | |
| t _{OSSL} | Output to Output Skew (Note 6) | | 1.0 | | | | | ns |
| t _{OSLH} | | | 1.0 | | | | | |
| Note 6: Skew is defined as the absolute value of the difference between the actual propagation delay for any two separate outputs of the same device. The specification applies to any outputs switching in the same direction, either HIGH-to-LOW (t _{OSSL}) or LOW-to-HIGH (t _{OSLH}). | | | | | | | | |
| Dynamic Switching Characteristics | | | | | | | | |
| Symbol | Parameter | Conditions | V _{CC} (V) | T _A = 25°C | | Units | | |
| | | | | Typical | | | | |
| V _{OLP} | Quiet Output Dynamic Peak V _{OL} | C _L = 50 pF, V _{IH} = 3.3V, V _{IL} = 0V | 3.3 | 0.35 | | V | | |
| | | C _L = 30 pF, V _{IH} = 2.5V, V _{IL} = 0V | 2.5 | 0.25 | | | | |
| V _{OLV} | Quiet Output Dynamic Valley V _{OL} | C _L = 50 pF, V _{IH} = 3.3V, V _{IL} = 0V | 3.3 | -0.35 | | V | | |
| | | C _L = 30 pF, V _{IH} = 2.5V, V _{IL} = 0V | 2.5 | -0.25 | | | | |
| Capacitance | | | | | | | | |
| Symbol | Parameter | Conditions | Typical | Units | | | | |
| C _{IN} | Input Capacitance | V _{CC} = Open, V _I = 0V or V _{CC} | 7.0 | pF | | | | |
| C _{OUT} | Output Capacitance | V _{CC} = 3.3V, V _I = 0V or V _{CC} | 8.0 | pF | | | | |
| C _{PD} | Power Dissipation Capacitance | V _{CC} = 3.3V, V _I = 0V or V _{CC} , f = 10 MHz | 25.0 | pF | | | | |

AC LOADING and WAVEFORMS Generic for LCX Family

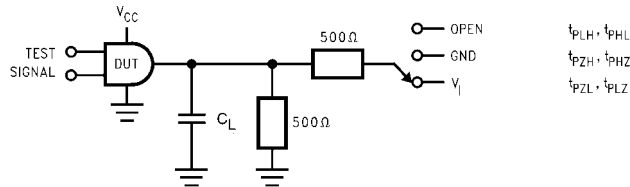
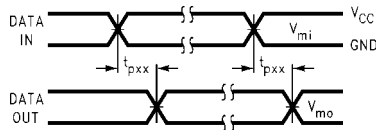
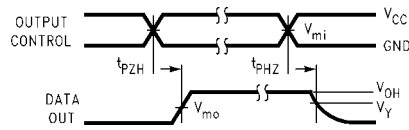

FIGURE 1. AC Test Circuit (C_L includes probe and jig capacitance)

| Test | Switch |
|--------------------|---|
| t_{PLH}, t_{PHL} | Open |
| t_{PZH}, t_{PHZ} | 6V at $V_{CC} = 3.3 \pm 0.3V$ $V_{CC} \times 2$ at $V_{CC} = 2.5 \pm 0.2V$ |
| t_{PZL}, t_{PLZ} | GND |



Waveform for Inverting and Non-Inverting Functions



3-STATE Output High Enable and Disable Times for Logic

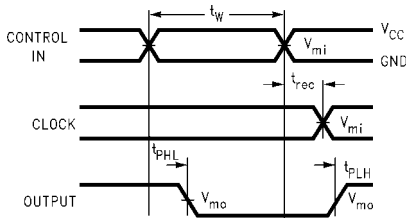

Propagation Delay, Pulse Width and t_{rec} Waveforms

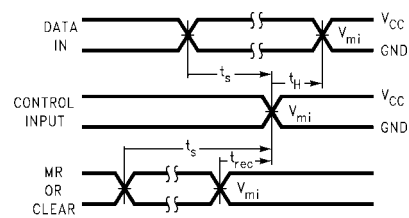

Setup Time, Hold Time and Recovery Time for Logic

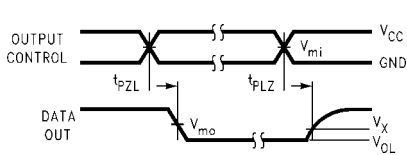

3-STATE Output Low Enable and Disable Times for Logic

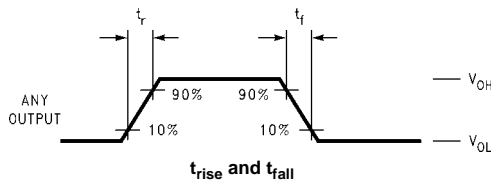
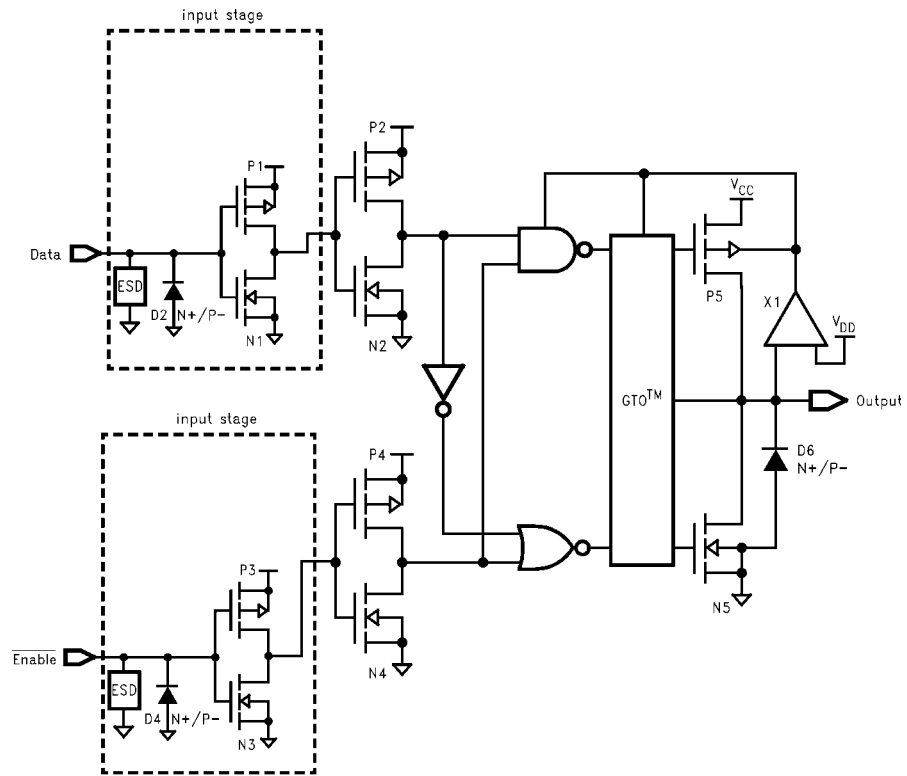

FIGURE 2. Waveforms
(Input Characteristics; $f = 1MHz, t_r = t_f = 3ns$)

| Symbol | V_{CC} | | |
|----------|-----------------|-----------------|------------------|
| | $3.3V \pm 0.3V$ | $2.7V$ | $2.5V \pm 0.2V$ |
| V_{mi} | 1.5V | 1.5V | $V_{CC}/2$ |
| V_{mo} | 1.5V | 1.5V | $V_{CC}/2$ |
| V_x | $V_{OL} + 0.3V$ | $V_{OL} + 0.3V$ | $V_{OL} + 0.15V$ |
| V_y | $V_{OH} - 0.3V$ | $V_{OH} - 0.3V$ | $V_{OH} - 0.15V$ |

Schematic Diagram Generic for LCX Family



Physical Dimensions inches (millimeters) unless otherwise noted

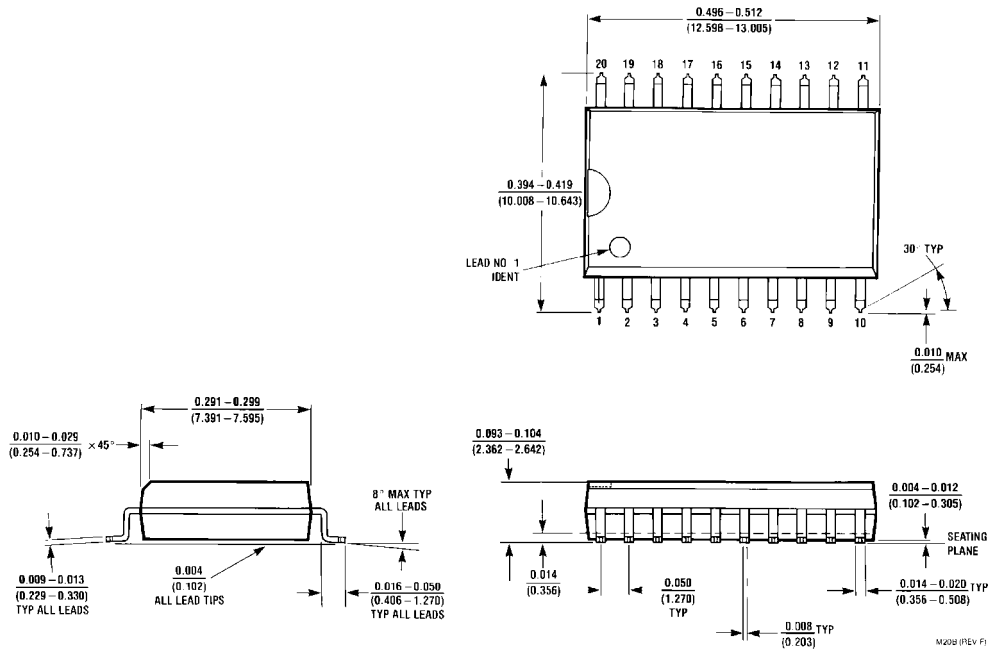

**20-Lead Small Outline Integrated Circuit (SOIC), JEDEC MS-013, 0.300" Wide
Package Number M20B**

Physical Dimensions inches (millimeters) unless otherwise noted (Continued)

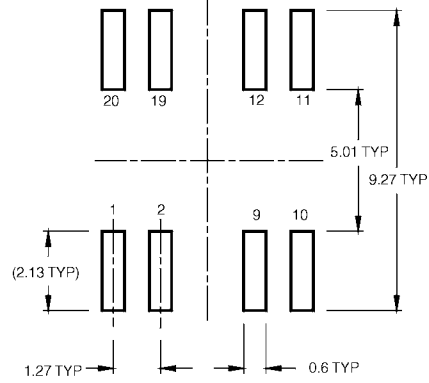
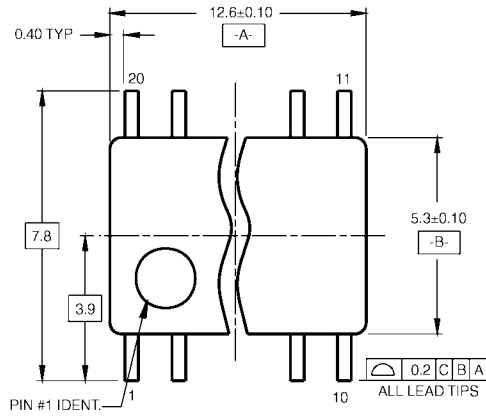

LAND PATTERN RECOMMENDATION

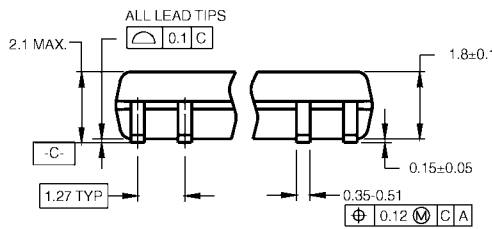

DIMENSIONS ARE IN MILLIMETERS

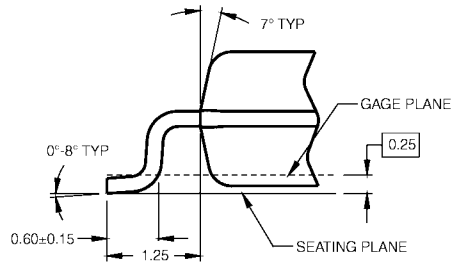
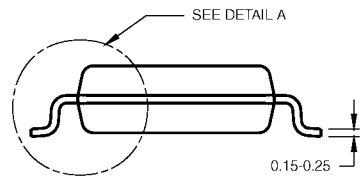

DETAIL A

NOTES:

- A. CONFORMS TO EIAJ EDR-7320 REGISTRATION, ESTABLISHED IN DECEMBER, 1998.
- B. DIMENSIONS ARE IN MILLIMETERS.
- C. DIMENSIONS ARE EXCLUSIVE OF BURRS, MOLD FLASH, AND TIE BAR EXTRUSIONS.

M20DRevB1

**20-Lead Small Outline Package (SOP), EIAJ TYPE II, 5.3mm Wide
Package Number M20D**

Physical Dimensions inches (millimeters) unless otherwise noted (Continued)

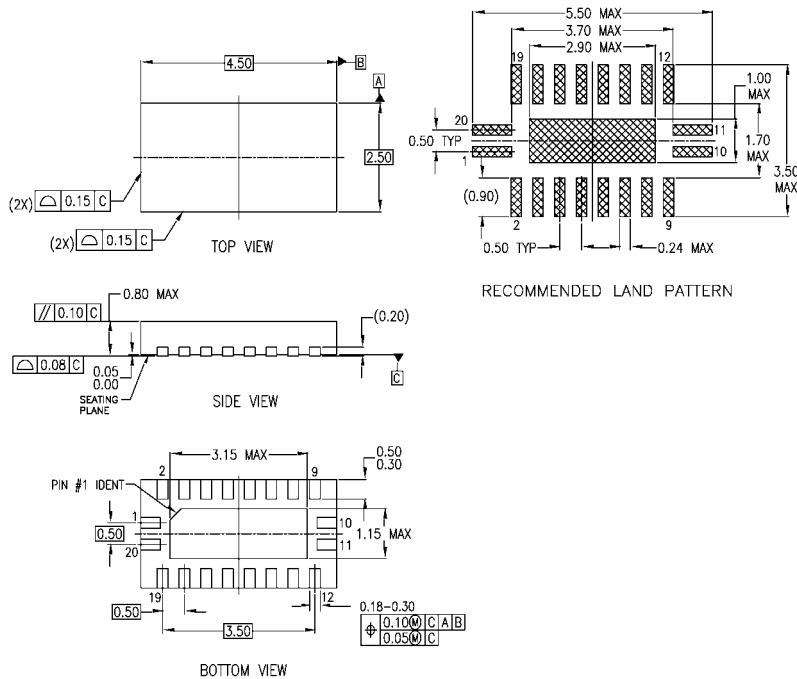

NOTES:

- A. CONFORMS TO JEDEC REGISTRATION MO-241, VARIATION AC
- B. DIMENSIONS ARE IN MILLIMETERS.
- C. DIMENSIONS AND TOLERANCES PER ASME Y14.5M, 1994

MLP020BrevA

**20-Terminal Depopulated Quad Very-Thin Flat Pack No Leads (DQFN), JEDEC MO-241, 2.5 x 4.5mm
Package Number MLP020B
(Preliminary)**

Physical Dimensions inches (millimeters) unless otherwise noted (Continued)

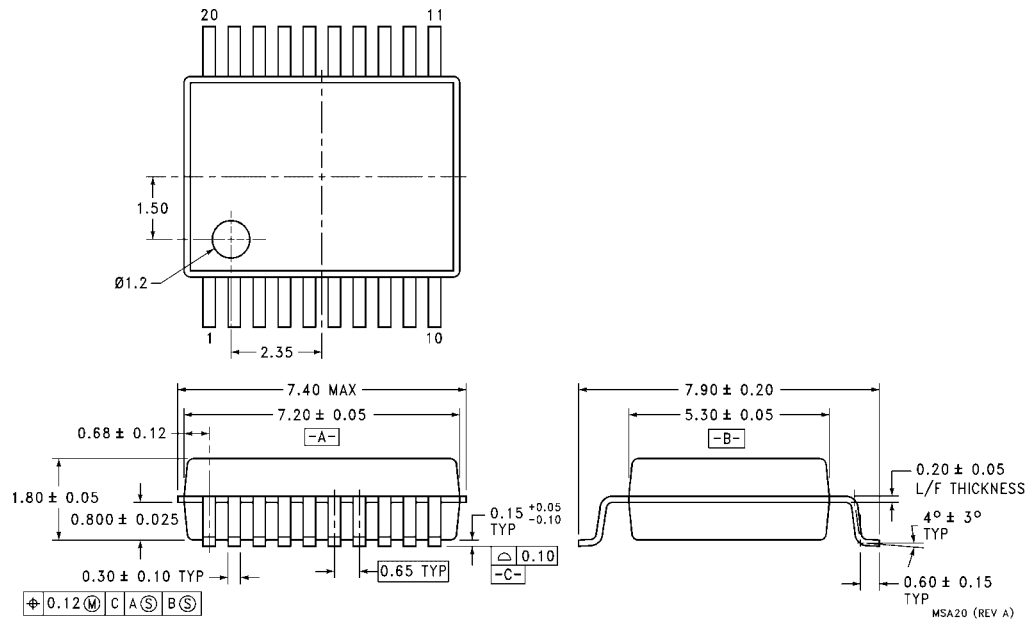

**20-Lead Shrink Small Outline Package (SSOP), JEDEC MO-150, 5.3mm Wide
Package Number MSA20**

Physical Dimensions inches (millimeters) unless otherwise noted (Continued)

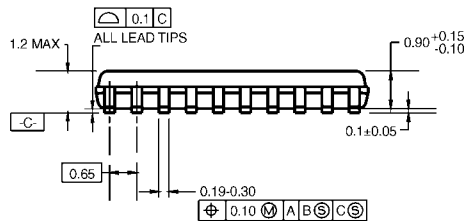
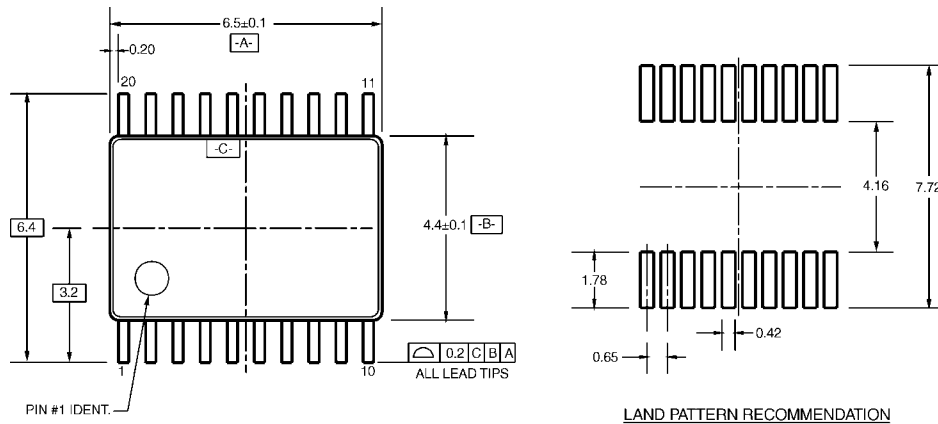

DIMENSIONS ARE IN MILLIMETERS

NOTES:

- A. CONFORMS TO JEDEC REGISTRATION MO-153, VARIATION AC, REF NOTE 6, DATE 7/93.
- B. DIMENSIONS ARE IN MILLIMETERS.
- C. DIMENSIONS ARE EXCLUSIVE OF BURRS, MOLD FLASH, AND TIE BAR EXTRUSIONS.
- D. DIMENSIONS AND TOLERANCES PER ANSI Y14.5M, 1982.

MTC20RevD1

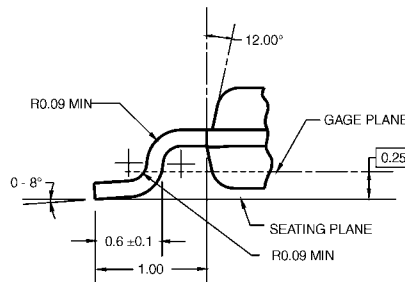
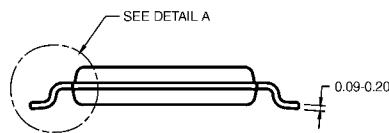

DETAIL A

**20-Lead Thin Shrink Small Outline Package (TSSOP), JEDEC MO-153, 4.4mm Wide
Package Number MTC20**

Fairchild does not assume any responsibility for use of any circuitry described, no circuit patent licenses are implied and Fairchild reserves the right at any time without notice to change said circuitry and specifications.

LIFE SUPPORT POLICY

FAIRCHILD'S PRODUCTS ARE NOT AUTHORIZED FOR USE AS CRITICAL COMPONENTS IN LIFE SUPPORT DEVICES OR SYSTEMS WITHOUT THE EXPRESS WRITTEN APPROVAL OF THE PRESIDENT OF FAIRCHILD SEMICONDUCTOR CORPORATION. As used herein:

1. Life support devices or systems are devices or systems which, (a) are intended for surgical implant into the body, or (b) support or sustain life, and (c) whose failure to perform when properly used in accordance with instructions for use provided in the labeling, can be reasonably expected to result in a significant injury to the user.
2. A critical component in any component of a life support device or system whose failure to perform can be reasonably expected to cause the failure of the life support device or system, or to affect its safety or effectiveness.

www.fairchildsemi.com

ON Semiconductor and  are trademarks of Semiconductor Components Industries, LLC dba ON Semiconductor or its subsidiaries in the United States and/or other countries. ON Semiconductor owns the rights to a number of patents, trademarks, copyrights, trade secrets, and other intellectual property. A listing of ON Semiconductor's product/patent coverage may be accessed at www.onsemi.com/site/pdf/Patent-Marking.pdf. ON Semiconductor reserves the right to make changes without further notice to any products herein. ON Semiconductor makes no warranty, representation or guarantee regarding the suitability of its products for any particular purpose, nor does ON Semiconductor assume any liability arising out of the application or use of any product or circuit, and specifically disclaims any and all liability, including without limitation special, consequential or incidental damages. Buyer is responsible for its products and applications using ON Semiconductor products, including compliance with all laws, regulations and safety requirements or standards, regardless of any support or applications information provided by ON Semiconductor. "Typical" parameters which may be provided in ON Semiconductor data sheets and/or specifications can and do vary in different applications and actual performance may vary over time. All operating parameters, including "Typicals" must be validated for each customer application by customer's technical experts. ON Semiconductor does not convey any license under its patent rights nor the rights of others. ON Semiconductor products are not designed, intended, or authorized for use as a critical component in life support systems or any FDA Class 3 medical devices or medical devices with a same or similar classification in a foreign jurisdiction or any devices intended for implantation in the human body. Should Buyer purchase or use ON Semiconductor products for any such unintended or unauthorized application, Buyer shall indemnify and hold ON Semiconductor and its officers, employees, subsidiaries, affiliates, and distributors harmless against all claims, costs, damages, and expenses, and reasonable attorney fees arising out of, directly or indirectly, any claim of personal injury or death associated with such unintended or unauthorized use, even if such claim alleges that ON Semiconductor was negligent regarding the design or manufacture of the part. ON Semiconductor is an Equal Opportunity/Affirmative Action Employer. This literature is subject to all applicable copyright laws and is not for resale in any manner.

PUBLICATION ORDERING INFORMATION

LITERATURE FULFILLMENT:

Literature Distribution Center for ON Semiconductor
19521 E. 32nd Pkwy, Aurora, Colorado 80011 USA
Phone: 303-675-2175 or 800-344-3860 Toll Free USA/Canada
Fax: 303-675-2176 or 800-344-3867 Toll Free USA/Canada
Email: orderlit@onsemi.com

N. American Technical Support: 800-282-9855 Toll Free
USA/Canada
Europe, Middle East and Africa Technical Support:
Phone: 421 33 790 2910
Japan Customer Focus Center
Phone: 81-3-5817-1050

ON Semiconductor Website: www.onsemi.com
Order Literature: <http://www.onsemi.com/orderlit>
For additional information, please contact your local
Sales Representative

Looking for pricing, stock, or lifecycle information?

Click below to explore more details on WIN SOURCE:

- ⊖ [View 74LCX2244MTCX on WIN SOURCE](#)
- ⊖ [Fairchild/ON Semiconductor Information](#)

Optimize Your Supply Chain with WIN SOURCE Solutions

- ✓ Global Sourcing Solution
- ✓ Obsolete Management
- ✓ Cost Control Management
- ✓ Shortage Management
- ✓ Alternative Solution
- ✓ Excess Inventory Management