



THE DATASHEET OF STS8C5H30L



N-channel 30 V, 0.018 Ω typ., 8 A, P-channel 30 V, 0.045 Ω typ., 5 A Power MOSFET in a SO-8 package

Datasheet - production data

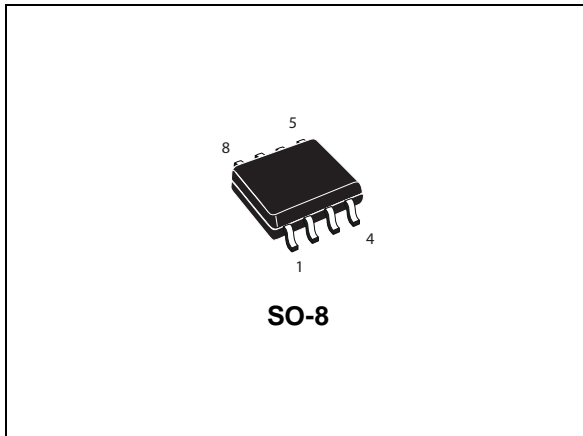
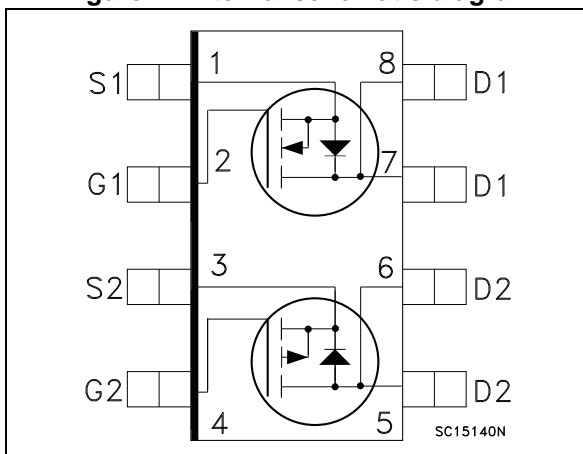

Figure 1. Internal schematic diagram



Features

Order code	Channel	V _{DS}	R _{DS(on)} max	I _D
STS8C5H30L	N	30 V	0.022 Ω	8 A
	P		0.055 Ω	5 A

- Conduction losses reduced
- Switching losses reduced
- Low threshold drive
- Standard outline for easy automated surface mount assembly

Applications

- Switching applications

Description

This device is a complementary N-channel and P-channel Power MOSFET developed using STripFET™ II (P-channel) and STripFET™ V (N-channel) technologies. The resulting transistors show extremely high packing density for low on-resistance and rugged avalanche characteristics.

Table 1. Device summary

Order code	Marking	Packages	Packaging
STS8C5H30L	8C5H30L	SO-8	Tape and reel

Contents

1	Electrical ratings	3
2	Electrical characteristics	4
2.1	Electrical characteristics (curves)	7
3	Test circuits	11
4	Package mechanical data	12
5	Packaging mechanical data	15
6	Revision history	17

1 Electrical ratings

Table 2. Absolute maximum ratings

Symbol	Parameter	Value		Unit
		N-channel	P-channel	
V_{DS}	Drain-source voltage	30		V
V_{GS}	Gate- source voltage	±16	±16	V
I_D	Drain current (continuous) at $T_C = 25^\circ\text{C}$ single operating	8	5.4	A
I_D	Drain current (continuous) at $T_C = 100^\circ\text{C}$ single operating	6.4	4.3	A
$I_{DM}^{(1)}$	Drain current (pulsed)	32	21.6	A
P_{TOT}	Total dissipation at $T_C = 25^\circ\text{C}$ dual operating	1.6		W
	Total dissipation at $T_C = 25^\circ\text{C}$ single operating	2		W
T_{stg}	Storage temperature	-55 to 150		$^\circ\text{C}$
T_j	Operating junction temperature	150		$^\circ\text{C}$

1. Pulse width limited by safe operating area

Table 3. Thermal data

Symbol	Parameter	Value	Unit
$R_{thj-a}^{(1)}$	Thermal resistance junction-ambient single operating	62.5	$^\circ\text{C}/\text{W}$
$R_{thj-a}^{(1)}$	Thermal resistance junction-ambient dual operating	78	$^\circ\text{C}/\text{W}$

1. When mounted on 1 inch² FR-4 board, 2 oz. Cu., $t \leq 10$ sec

Note: For the p-channel MOSFET actual polarity of voltages and current has to be reversed

2 Electrical characteristics

($T_{CASE} = 25\text{ °C}$ unless otherwise specified)

Table 4. On/off states

Symbol	Parameter	Test conditions	Channel	Min.	Typ.	Max.	Unit
$V_{(BR)DSS}$	Drain-source breakdown voltage	$V_{GS} = 0, I_D = 250\ \mu A$	N	30			V
			P	30			V
I_{DSS}	Zero gate voltage drain current	$V_{GS} = 0, V_{DS} = 30\ V$	N			1	μA
		$V_{GS} = 0, V_{DS} = 30\ V, T_C = 125\text{ °C}$	P			10	μA
I_{GSS}	Gate-body leakage current	$V_{DS} = 0, V_{GS} = \pm 16\ V$	N			± 100	nA
		$V_{DS} = 0, V_{GS} = \pm 16\ V$	P			± 100	nA
$V_{GS(th)}$	Gate threshold voltage	$V_{DS} = V_{GS}, I_D = 250\ \mu A$	N	1	1.6	2.5	V
			P	1	1.6	2.5	V
$R_{DS(on)}$	Static drain-source on-resistance	$V_{GS} = 10\ V, I_D = 4\ A$	N		0.018	0.022	Ω
		$V_{GS} = 10\ V, I_D = 2.5\ A$	P		0.045	0.055	Ω
		$V_{GS} = 4.5\ V, I_D = 4\ A$	N		0.020	0.025	Ω
		$V_{GS} = 4.5\ V, I_D = 2.5\ A$	P		0.070	0.075	Ω

Table 5. Dynamic

Symbol	Parameter	Test conditions	Channel	Min.	Typ.	Max.	Unit
$g_{fs}^{(1)}$	Forward transconductance	$V_{DS} = 15\text{ V}, I_D = 4\text{ A}$	N	-	8.5		S
		$V_{DS} = 15\text{ V}, I_D = 2.5\text{ A}$	P	-	10		S
C_{iss}	Input capacitance	$V_{GS} = 0, V_{DS} = 25\text{ V}, f = 1\text{ MHz}$	N	-	857		pF
			P	-	1350		pF
C_{oss}	Output capacitance		N	-	147		pF
			P	-	490		pF
C_{rss}	Reverse transfer capacitance		N	-	20		pF
			P	-	130		pF
Q_g	Total gate charge	N-channel $V_{DD} = 24\text{ V}, I_D = 8\text{ A}$ $V_{GS} = 5\text{ V}$	N	-	7	10	nC
			P	-	12.5	16	nC
Q_{gs}	Gate-source charge	P-channel $V_{DD} = 24\text{ V}, I_D = 4\text{ A}$ $V_{GS} = 5\text{ V}$	N	-	2.5		nC
			P	-	5		nC
Q_{gd}	Gate-drain charge	<i>(see Figure 27)</i>	N	-	2.3		nC
			P	-	3		nC

1. Pulsed: Pulse duration = 300 μ s, duty cycle 1.5.

For the p-channel MOSFET actual polarity of voltages and current has to be reversed

Table 6. Switching times

Symbol	Parameter	Test conditions	Channel	Min.	Typ.	Max.	Unit	
$t_{d(on)}$	Turn-on delay time	$V_{DD} = 15\text{ V}, I_D = 4\text{ A}$ $R_G = 4.7\ \Omega, V_{GS} = 4.5\text{ V}$	N	-	12	-	ns	
			P	-	25	-	ns	
t_r	Rise time		N	-	14.5	-	ns	
			P	-	35	-	ns	
$t_{d(off)}$	Turn-off delay time		$V_{DD} = 15\text{ V}, I_D = 2\text{ A}$ $R_G = 4.7\ \Omega, V_{GS} = 4.5\text{ V}$ <i>Figure 26</i>	N	-	23	-	ns
				P	-	125	-	ns
t_f	Fall time	N		-	8	-	ns	
		P		-	35	-	ns	

Table 7. Source drain diode

Symbol	Parameter	Test conditions	Channel	Min.	Typ.	Max.	Unit
I_{SD}	Source-drain current		N	-		8	A
			P	-		5	A
$I_{SDM}^{(1)}$	Source-drain current (pulsed)		N	-		32	A
			P	-		20	A
$V_{SD}^{(2)}$	Forward on voltage	$I_{SD} = 8\text{ A}, V_{GS} = 0$	N	-		1.5	V
		$I_{SD} = 5\text{ A}, V_{GS} = 0$	P	-		1.2	V
t_{rr}	Reverse recovery time	N-channel $I_{SD} = 8\text{ A}, di/dt = 100\text{ A}/\mu\text{s}$ $V_{DD} = 15\text{ V}, T_j = 150\text{ }^\circ\text{C}$	N	-	15		ns
			P	-	45		ns
Q_{rr}	Reverse recovery charge	P-channel $I_{SD} = 5\text{ A}, di/dt = 100\text{ A}/\mu\text{s}$ $V_{DD} = 15\text{ V}, T_j = 150\text{ }^\circ\text{C}$	N	-	5.7		nC
			P	-	36		nC
I_{RRM}	Reverse recovery current	$V_{DD} = 15\text{ V}, T_j = 150\text{ }^\circ\text{C}$ <i>Figure 28</i>	N	-	0.76		A
			P	-	1.6		A

1. Pulse width limited by safe operating area.

2. Pulsed: Pulse duration = 300 μs , duty cycle 1.5%

Note: For the p-channel MOSFET actual polarity of voltages and current has to be reversed

2.1 Electrical characteristics (curves)

Figure 2. Safe operating area n-ch

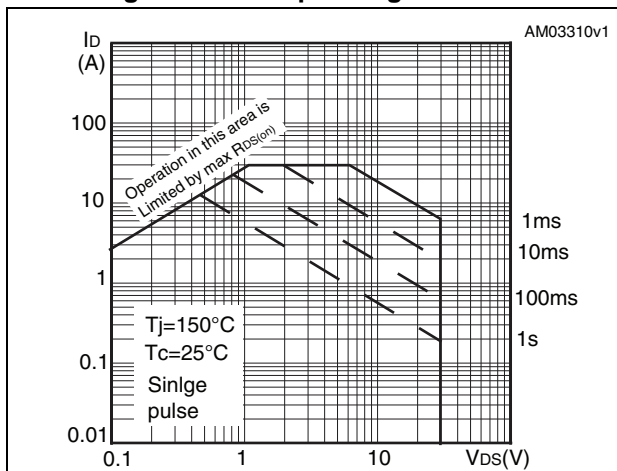

Figure 3. Thermal impedance n-ch

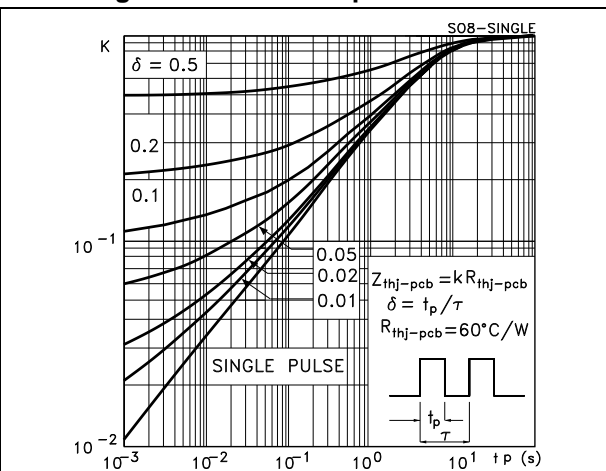

Figure 4. Output characteristics n-ch

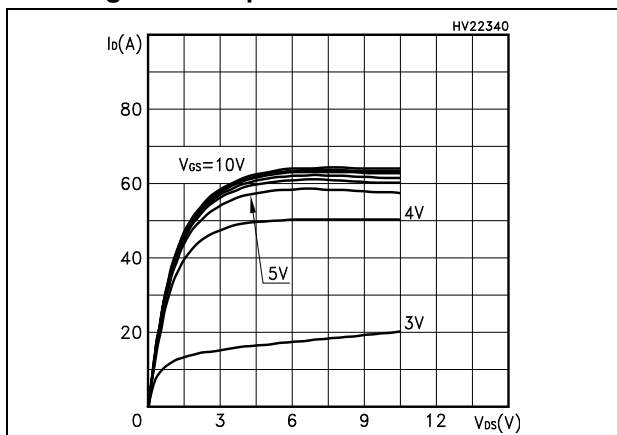

Figure 5. Transfer characteristics n-ch

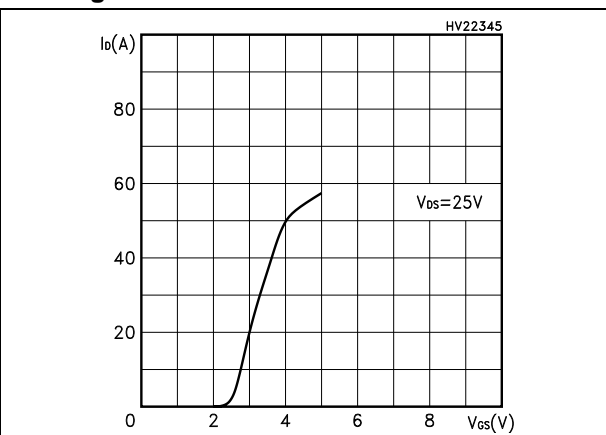

Figure 6. Transconductance n-ch

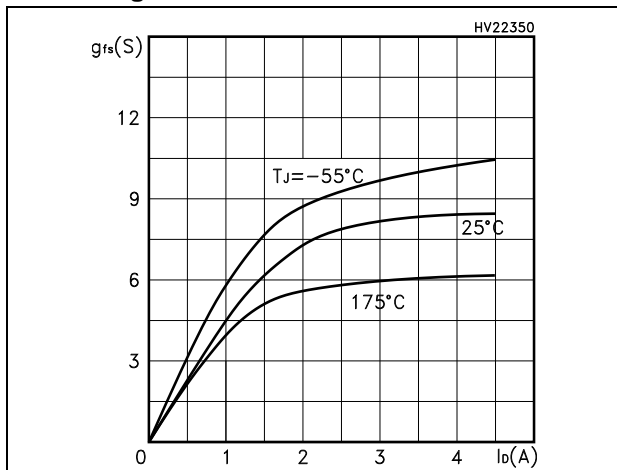

Figure 7. Static drain-source on resistance n-ch

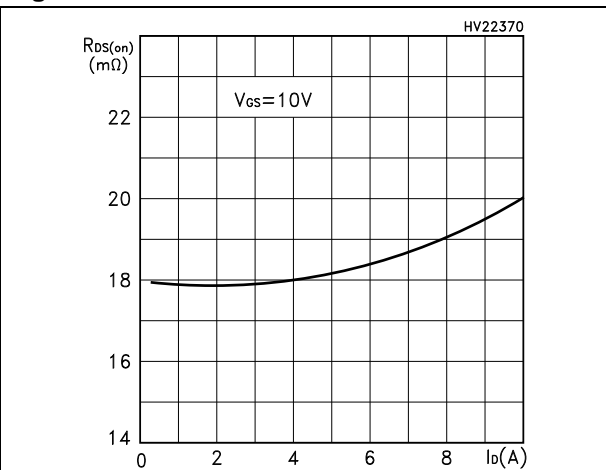

Figure 8. Gate charge vs. gate-source voltage n-ch

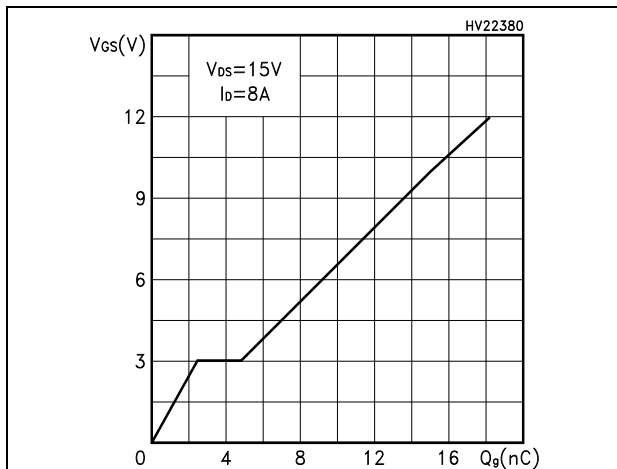

Figure 9. Capacitance variations n-ch

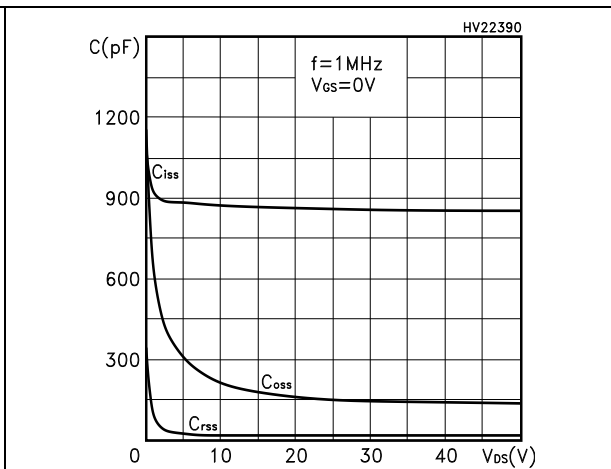

Figure 10. Normalized gate threshold voltage vs. temperature n-ch

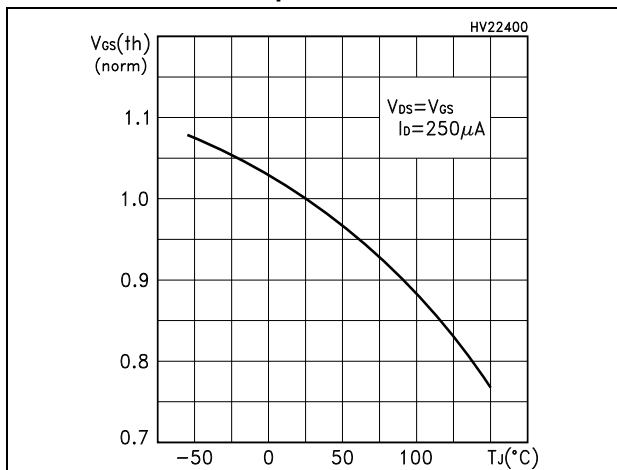

Figure 11. Normalized on resistance vs. temperature n-ch

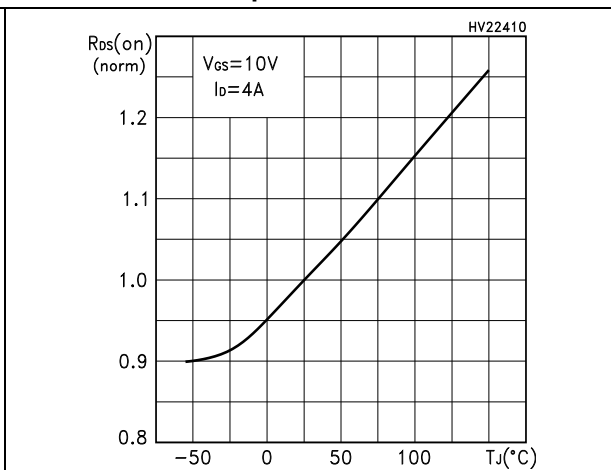

Figure 12. Source-drain diode forward characteristics n-ch

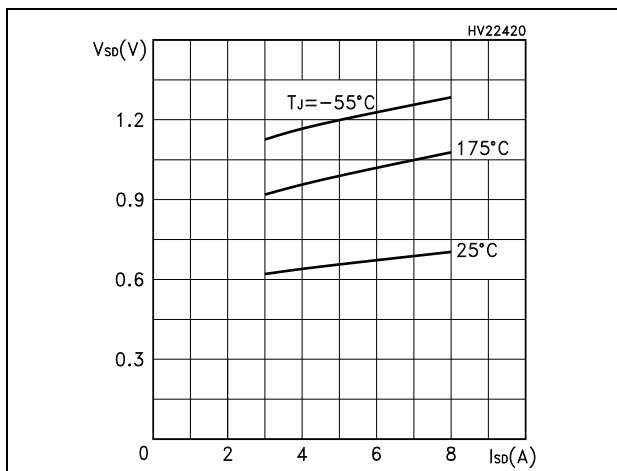

Figure 13. Normalized breakdown voltage vs. temperature n-ch

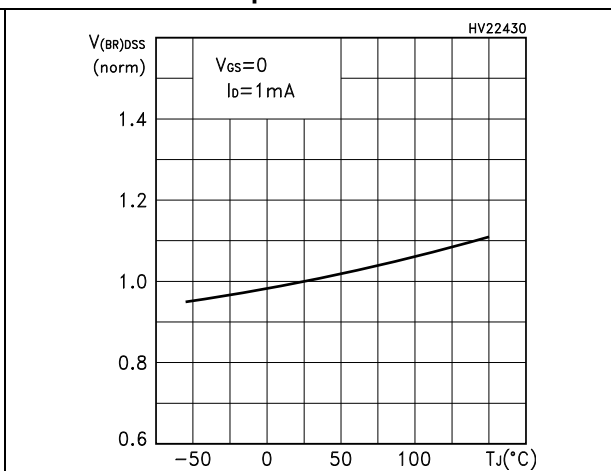

Figure 14. Safe operating area p-ch

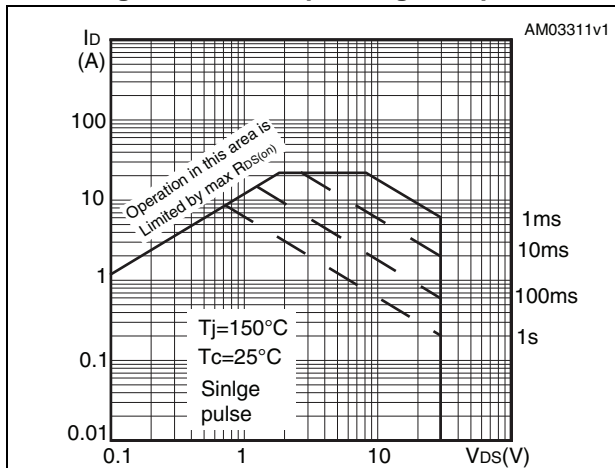

Figure 15. Thermal impedance p-ch

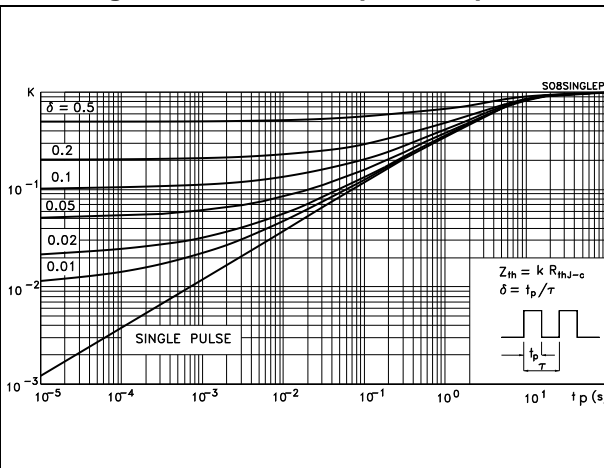

Figure 16. Output characteristics p-ch

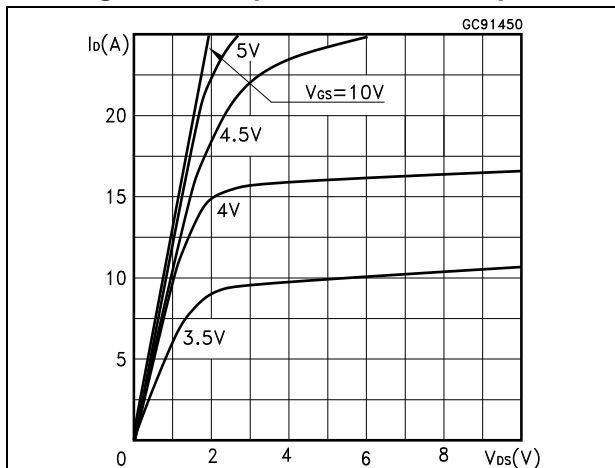

Figure 17. Transfer characteristics p-ch

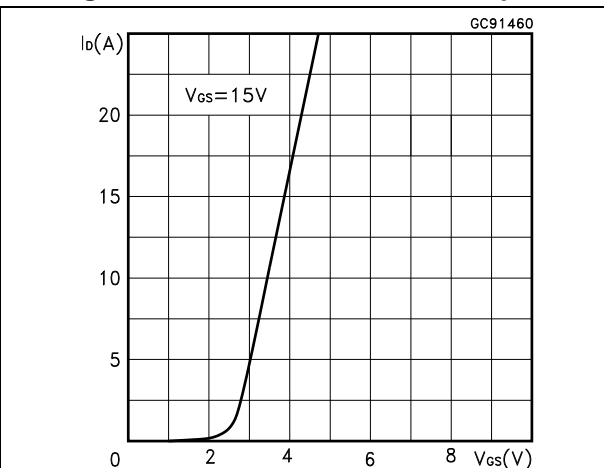

Figure 18. Transconductance p-ch

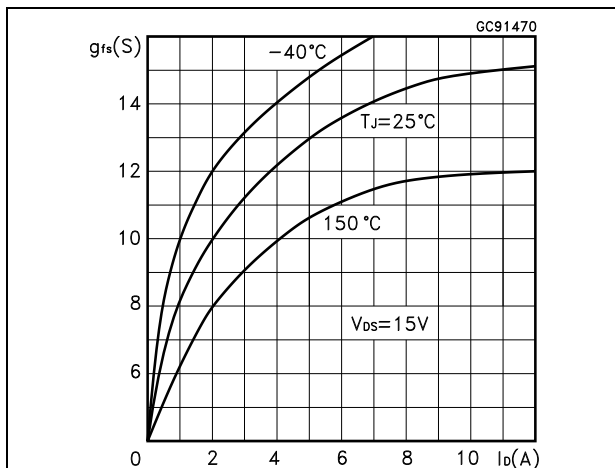

Figure 19. Static drain-source on resistance p-ch

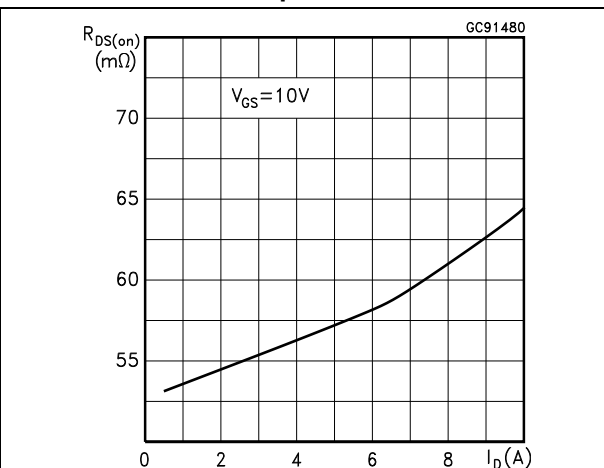

Figure 20. Gate charge vs. gate-source voltage p-ch

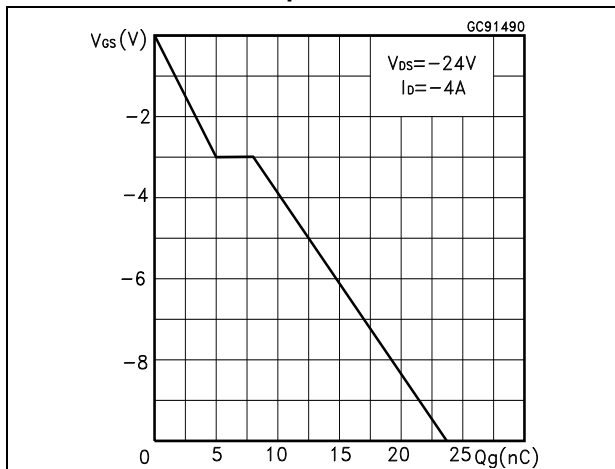

Figure 21. Capacitance variations p-ch

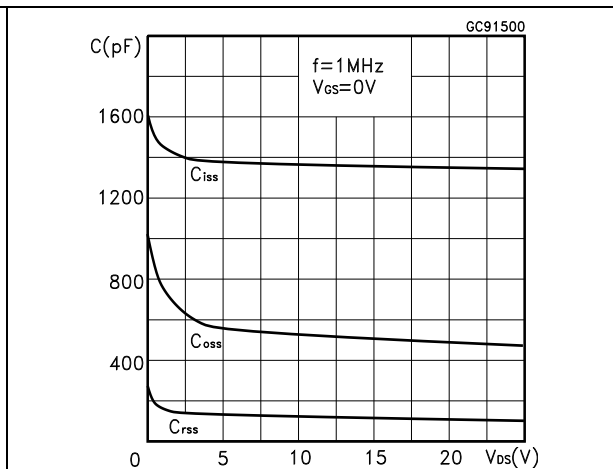

Figure 22. Normalized gate threshold voltage vs. temperature p-ch

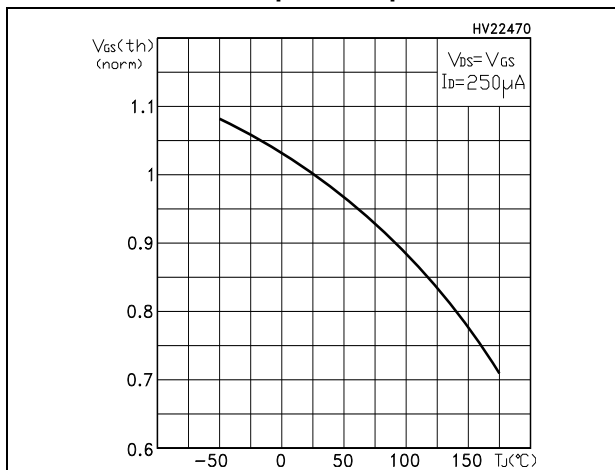

Figure 23. Normalized on resistance vs. temperature p-ch

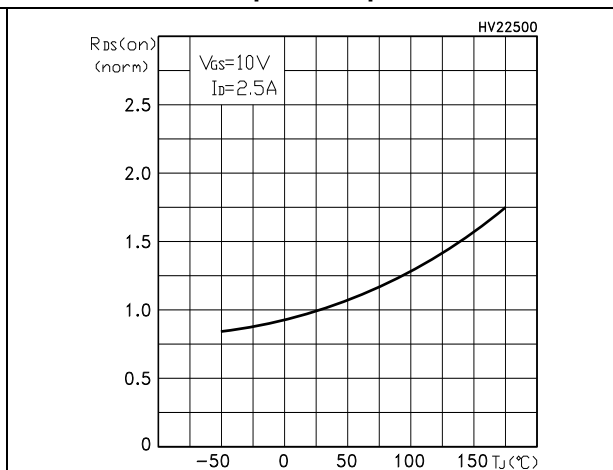

Figure 24. Source-drain diode forward characteristics p-ch

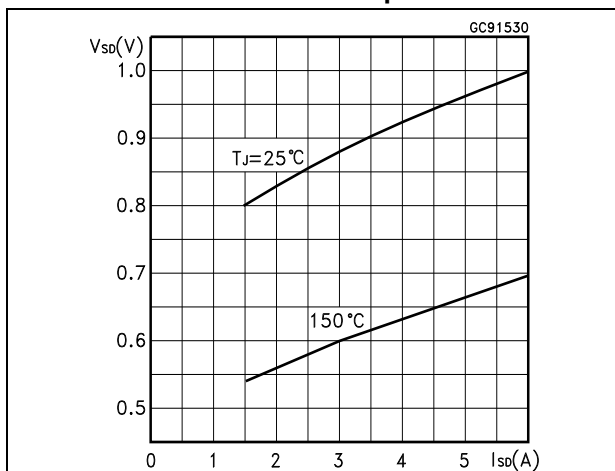
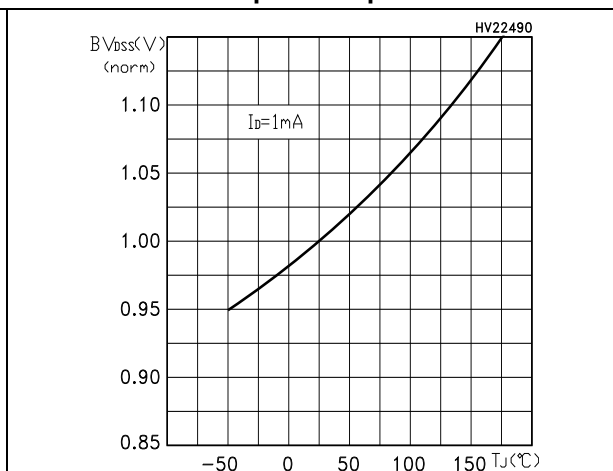
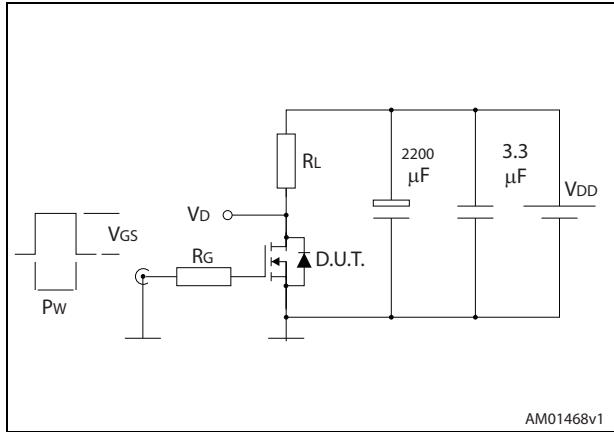

Figure 25. Normalized breakdown voltage vs. temperature p-ch



3 Test circuits

Figure 26. Switching times test circuit for resistive load



AM01468v1

Figure 27. Gate charge test circuit

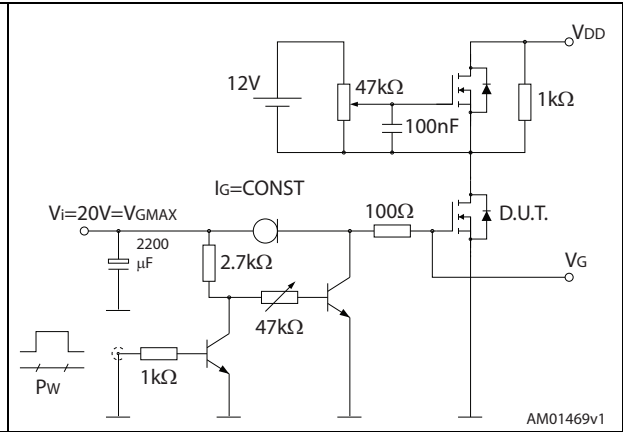

AM01469v1

Figure 28. Test circuit for inductive load switching and diode recovery times

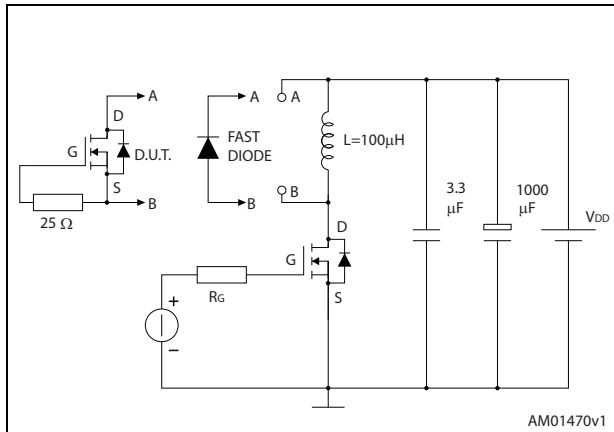

AM01470v1

Figure 29. Unclamped inductive load test circuit

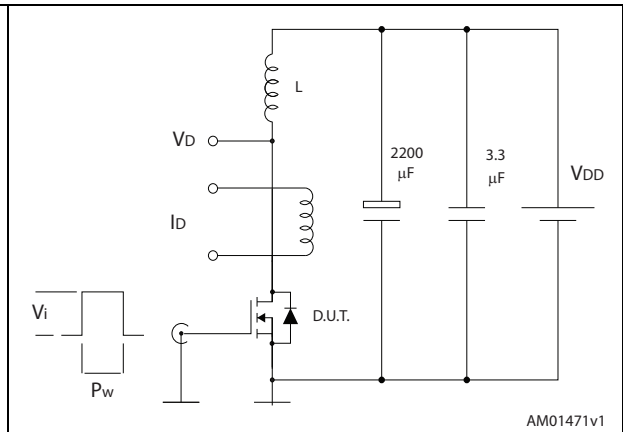

AM01471v1

Figure 30. Unclamped inductive waveform

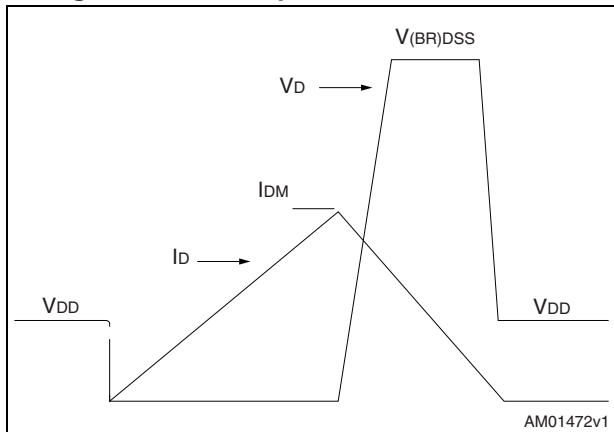

AM01472v1

Figure 31. Switching time waveform

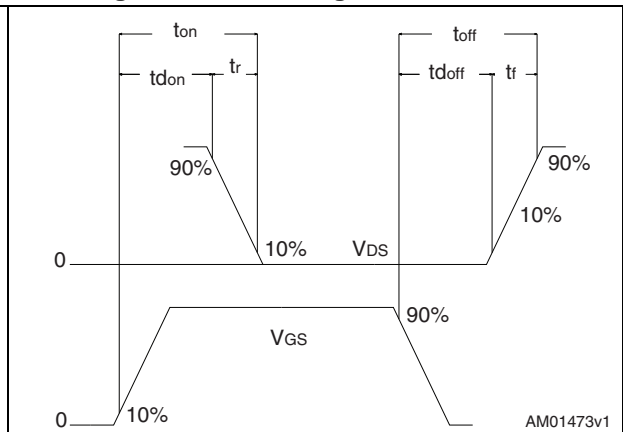

AM01473v1

4 Package mechanical data

In order to meet environmental requirements, ST offers these devices in different grades of ECOPACK[®] packages, depending on their level of environmental compliance. ECOPACK[®] specifications, grade definitions and product status are available at: www.st.com. ECOPACK[®] is an ST trademark.

Figure 32. SO-8 drawing

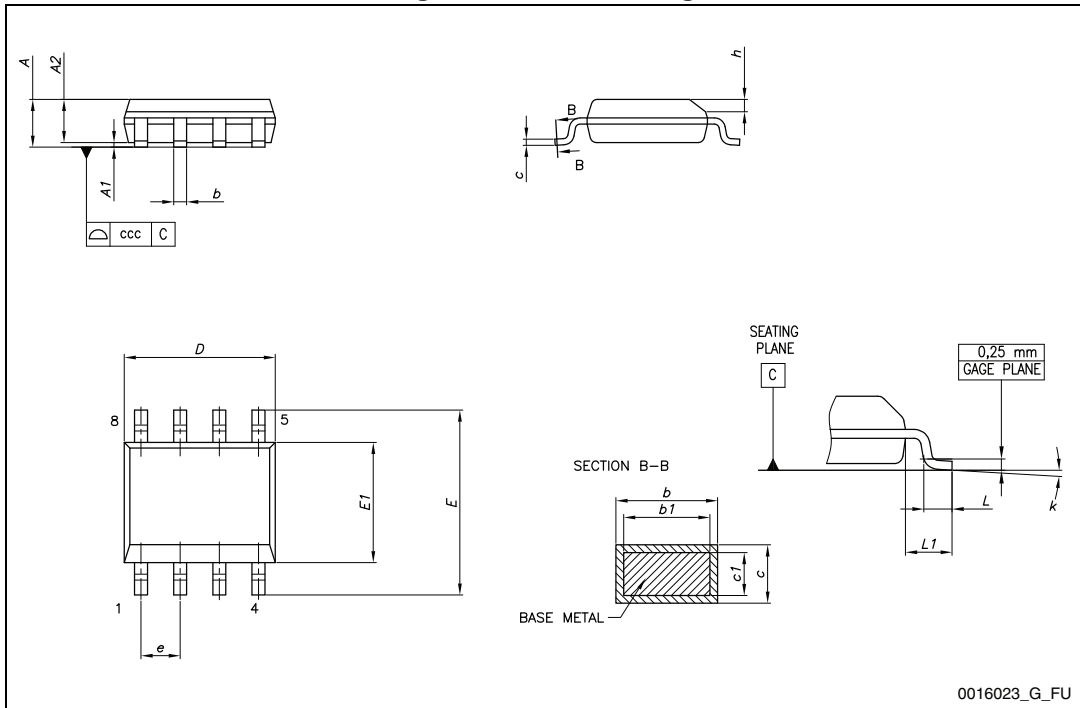
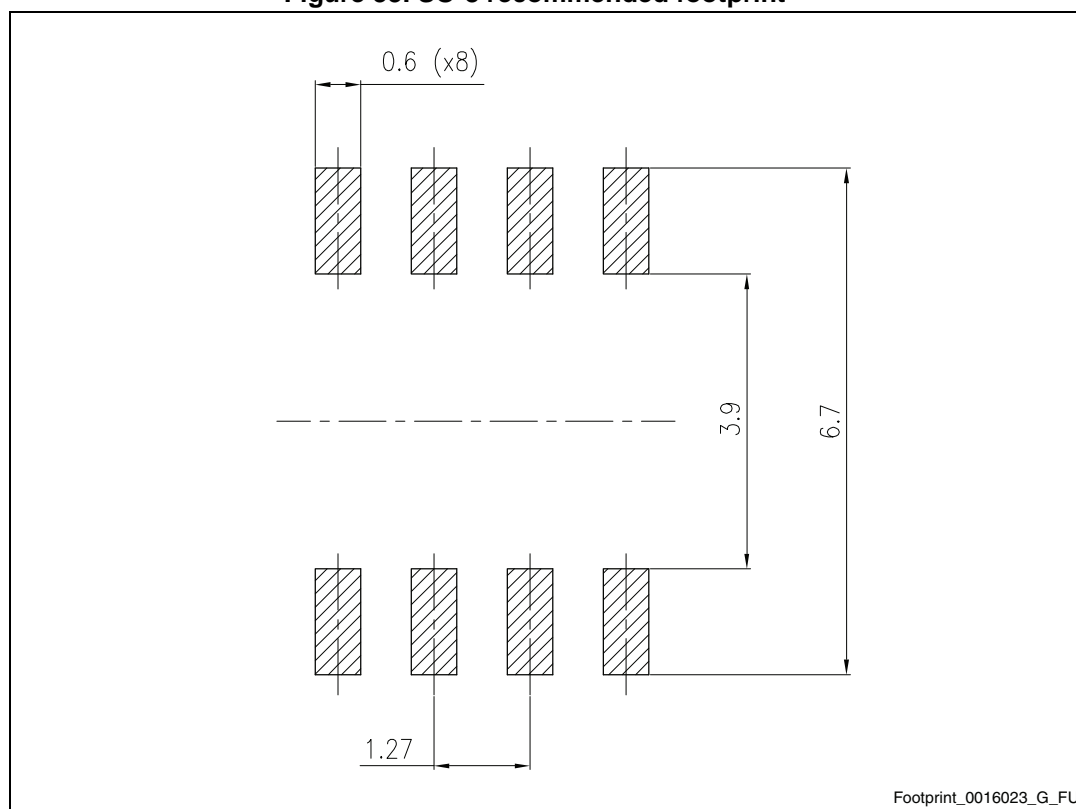

Table 8. SO-8 mechanical data

Dim.	mm		
	Min.	Typ.	Max.
A			1.75
A1	0.10		0.25
A2	1.25		
b	0.31		0.51
b1	0.28		0.48
c	0.10		0.25
c1	0.10		0.23
D	4.80	4.90	5.00
E	5.80	6.00	6.20
E1	3.80	3.90	4.00
e		1.27	
h	0.25		0.50
L	0.40		1.27
L1		1.04	
L2		0.25	
k	0°		8°
ccc			0.10

Figure 33. SO-8 recommended footprint^(a)



a. All dimensions are in millimeters.

5 Packaging mechanical data

Figure 34. SO-8 tape and reel dimensions

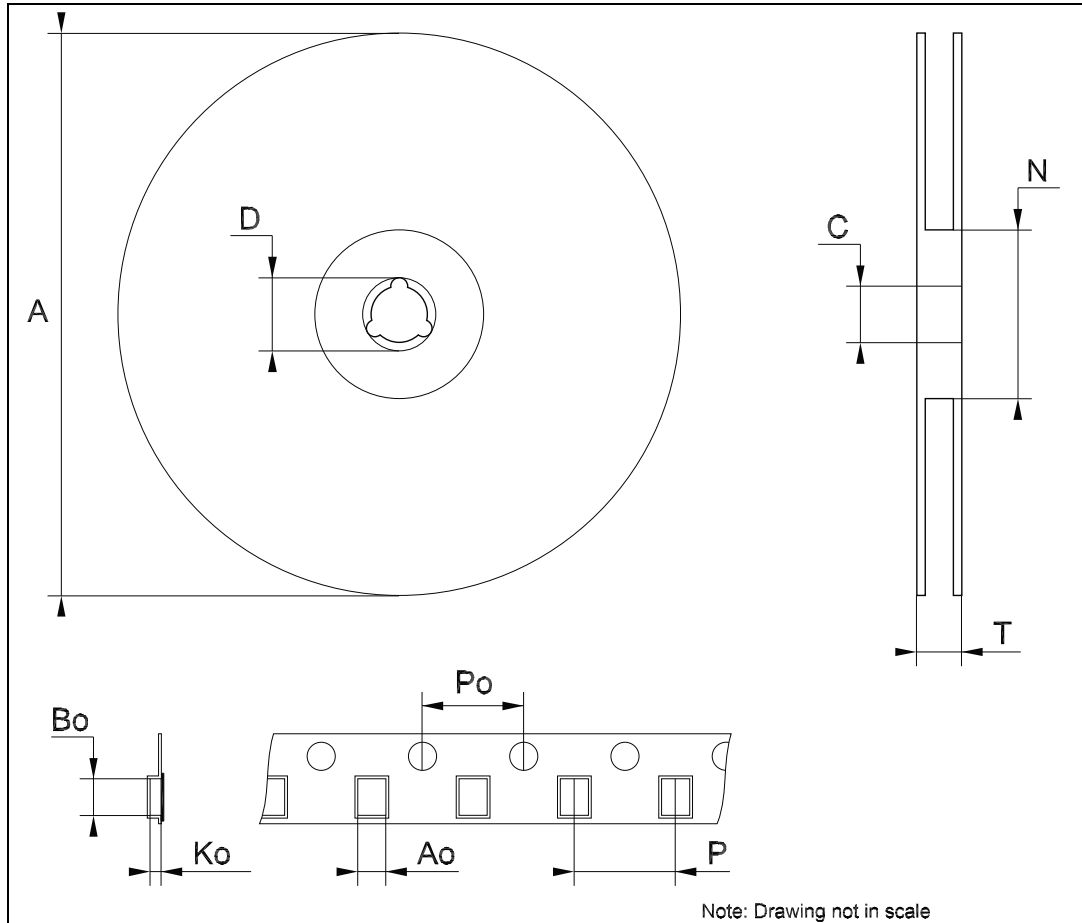

Table 9. SO-8 tape and reel mechanical data

Dim.	mm		
	Min.	Typ.	Max.
A		-	330
C	12.8	-	13.2
D	20.2	-	
N	60	-	
T		-	22.4
Ao	8.1	-	8.5
Bo	5.5	-	5.9
Ko	2.1	-	2.3
Po	3.9	-	4.1
P	7.9	-	8.1

6 Revision history

Table 10. Revision history

Date	Revision	Changes
17-Sep-2004	1	First revision.
31-Oct-2006	2	The document has been reformatted.
30-Jan-2007	3	typo mistake on Table 2 .
23-Jul-2007	4	Figure 14 has been updated.
23-Feb-2009	5	Figure 2 , Figure 3 , Figure 14 and Figure 15 have been changed.
10-Jun-2010	6	Updated $V_{GS(th)}$ in Table 4: On/off states .
13-Jun-2014	7	<ul style="list-style-type: none">– Modified: title– Modified: Description– Modified: marking in Table 1– Updated: Section 4: Package mechanical data– Minor text changes

Please Read Carefully:

Information in this document is provided solely in connection with ST products. STMicroelectronics NV and its subsidiaries ("ST") reserve the right to make changes, corrections, modifications or improvements, to this document, and the products and services described herein at any time, without notice.

All ST products are sold pursuant to ST's terms and conditions of sale.

Purchasers are solely responsible for the choice, selection and use of the ST products and services described herein, and ST assumes no liability whatsoever relating to the choice, selection or use of the ST products and services described herein.

No license, express or implied, by estoppel or otherwise, to any intellectual property rights is granted under this document. If any part of this document refers to any third party products or services it shall not be deemed a license grant by ST for the use of such third party products or services, or any intellectual property contained therein or considered as a warranty covering the use in any manner whatsoever of such third party products or services or any intellectual property contained therein.

UNLESS OTHERWISE SET FORTH IN ST'S TERMS AND CONDITIONS OF SALE ST DISCLAIMS ANY EXPRESS OR IMPLIED WARRANTY WITH RESPECT TO THE USE AND/OR SALE OF ST PRODUCTS INCLUDING WITHOUT LIMITATION IMPLIED WARRANTIES OF MERCHANTABILITY, FITNESS FOR A PARTICULAR PURPOSE (AND THEIR EQUIVALENTS UNDER THE LAWS OF ANY JURISDICTION), OR INFRINGEMENT OF ANY PATENT, COPYRIGHT OR OTHER INTELLECTUAL PROPERTY RIGHT.

ST PRODUCTS ARE NOT DESIGNED OR AUTHORIZED FOR USE IN: (A) SAFETY CRITICAL APPLICATIONS SUCH AS LIFE SUPPORTING, ACTIVE IMPLANTED DEVICES OR SYSTEMS WITH PRODUCT FUNCTIONAL SAFETY REQUIREMENTS; (B) AERONAUTIC APPLICATIONS; (C) AUTOMOTIVE APPLICATIONS OR ENVIRONMENTS, AND/OR (D) AEROSPACE APPLICATIONS OR ENVIRONMENTS. WHERE ST PRODUCTS ARE NOT DESIGNED FOR SUCH USE, THE PURCHASER SHALL USE PRODUCTS AT PURCHASER'S SOLE RISK, EVEN IF ST HAS BEEN INFORMED IN WRITING OF SUCH USAGE, UNLESS A PRODUCT IS EXPRESSLY DESIGNATED BY ST AS BEING INTENDED FOR "AUTOMOTIVE, AUTOMOTIVE SAFETY OR MEDICAL" INDUSTRY DOMAINS ACCORDING TO ST PRODUCT DESIGN SPECIFICATIONS. PRODUCTS FORMALLY ESCC, QML OR JAN QUALIFIED ARE DEEMED SUITABLE FOR USE IN AEROSPACE BY THE CORRESPONDING GOVERNMENTAL AGENCY.

Resale of ST products with provisions different from the statements and/or technical features set forth in this document shall immediately void any warranty granted by ST for the ST product or service described herein and shall not create or extend in any manner whatsoever, any liability of ST.

ST and the ST logo are trademarks or registered trademarks of ST in various countries.

Information in this document supersedes and replaces all information previously supplied.

The ST logo is a registered trademark of STMicroelectronics. All other names are the property of their respective owners.

© 2014 STMicroelectronics - All rights reserved

STMicroelectronics group of companies

Australia - Belgium - Brazil - Canada - China - Czech Republic - Finland - France - Germany - Hong Kong - India - Israel - Italy - Japan - Malaysia - Malta - Morocco - Philippines - Singapore - Spain - Sweden - Switzerland - United Kingdom - United States of America

www.st.com

Looking for pricing, stock, or lifecycle information?

Click below to explore more details on WIN SOURCE:

- ⊖ [View STS8C5H30L on WIN SOURCE](#)
- ⊖ [STMicroelectronics Information](#)

Optimize Your Supply Chain with WIN SOURCE Solutions

- ✓ Global Sourcing Solution
- ✓ Obsolete Management
- ✓ Cost Control Management
- ✓ Shortage Management
- ✓ Alternative Solution
- ✓ Excess Inventory Management