









THE DATASHEET OF T5049NL

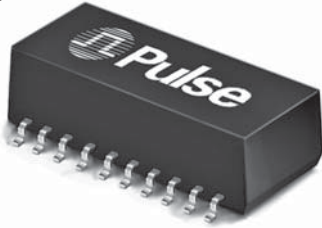

ISDN S-INTERFACE MODULES

Surface Mount, Dual, 1500 Vrms



-  RoHS peak reflow temperature rating 245°C
-  Meets the pulse waveform template of CCITT I.430 when recommended transformer and chip pair are used
-  Developed for enhanced EMC performance
-  Excellent longitudinal balance
-  Low- or high-frequency choke options available

Electrical Specifications @ 25°C — Operating Temperature 0°C to 70°C

RoHS Compliant Part Number	Ratio (± 2%)	OCL Pri (mH MIN)	Ll Sec (µH MAX)	Cw/w (pF MAX)	CD Pri (pF MAX)	DCR Pri (Ω +25% MAX)	DCR Sec (Ω +25% MAX)	D lbc (mA MAX)	Isolation Voltage (Vrms MIN)	Δ lbc (mA MAX)	Secondary Pins
	Transformers						Chokes				
T5049NL	1CT:1CT	30	10	150	100	3.4	3.4	4.7 mH	1.4	3	20-18, 13-11

NOTE: When ordering Tape & Reel packaging, add a "T" suffix to the part number (ex: T5049NLT).

Mechanical

Schematic

T5049NL

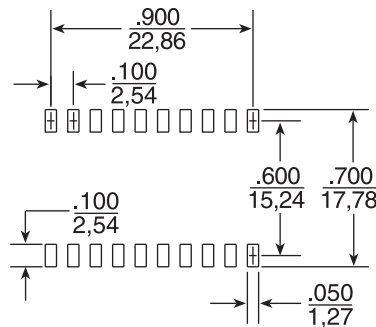
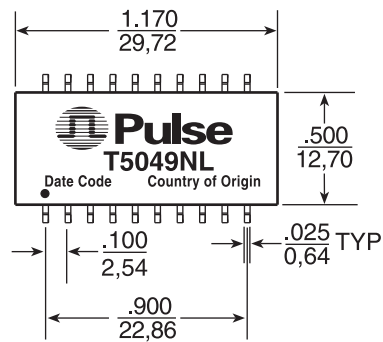

SUGGESTED PAD LAYOUT

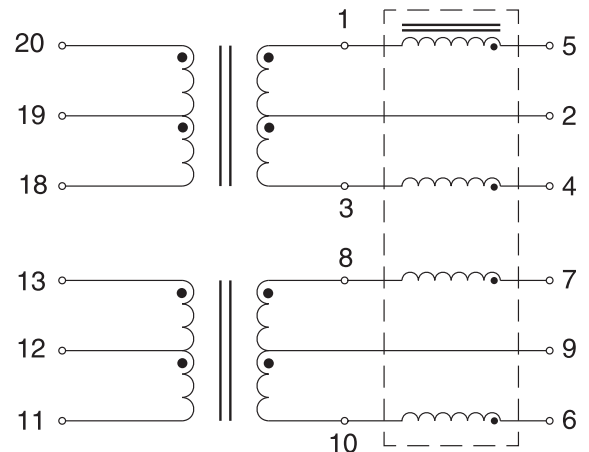
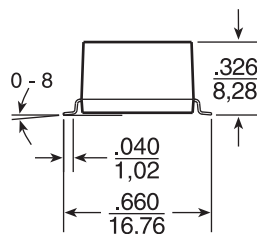
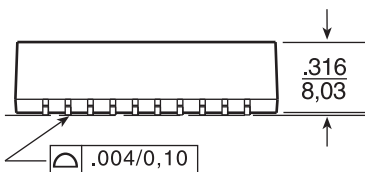

Weight 6.94 grams
 Tape & Reel250/reel
 Tube 15/tube

Dimensions: $\frac{\text{Inches}}{\text{mm}}$

Unless otherwise specified, all tolerances are $\pm \frac{.010}{0,25}$

ISDN S-INTERFACE MODULES

Surface Mount, Dual, 1500 Vrms



Module Selection Guide		
IC Manufacturer	IC Part Number	Pulse Part Number
Siemens	PEB2080/2081/2084/2085/2086 PSB 2186 PSB 21381/21382/21383/21384	T5049NL

Definition of Terms

- Ratio:** This is the turns ratio, expressed as “Primary:Secondary”. The term “CT” designates a center-tapped winding.
- OCL:** Open Circuit Inductance, measured 20 kHz, 100 mV.
- L_L Sec:** Leakage Inductance measured across the primary with the respective secondary winding short-circuited.
- C_{w/w}:** Winding capacitance, formed by the primary and secondary wire. These wires form the “Plates” of this capacitor. Measured at 100 kHz, 20 mV.
- CD Pri:** This is the distributed capacitance.
- DCR:** This is the resistance of the windings when measured in DC conditions.
- Δ I_{DC}:** The maximum specified unbalanced DC current capability of the device.

The minimum primary inductance and the maximum distributed capacitance satisfy the transmitter output and receiver input impedance requirements of CCITT I.430 for both TE and NT.

The maximum distributed capacitance allows sufficient margin for the capacitance of the IC and a protection diode network. It is consistent with the overall maximum value specified and permitted length of the basic access TE cord.

Flammability – Materials used in the products are recognized UL94-VO. Products meet the requirements of IEC 695-2-2 (needle flame test).

ISDN S-INTERFACE MODULES

Surface Mount, Dual, 1500 Vrms



Application Notes

The S-Interface is the standardized four wire digital telephone access point defined by the CCITT I-Series recommendations for the Integrated Service Digital Network. This "basic rate access" accommodates two 64 Kbps "B-channels" for information, one 16 Kbps "D-channel" intended

for signaling and control, and 48 Kbps for framing and other purposes, giving a total rate of 192 Kbps. The CCITT physical layer recommends that the user network interface be transformer coupled as shown in our typical application notes.

Typical S-Interface Application Circuit for Motorola MC145574

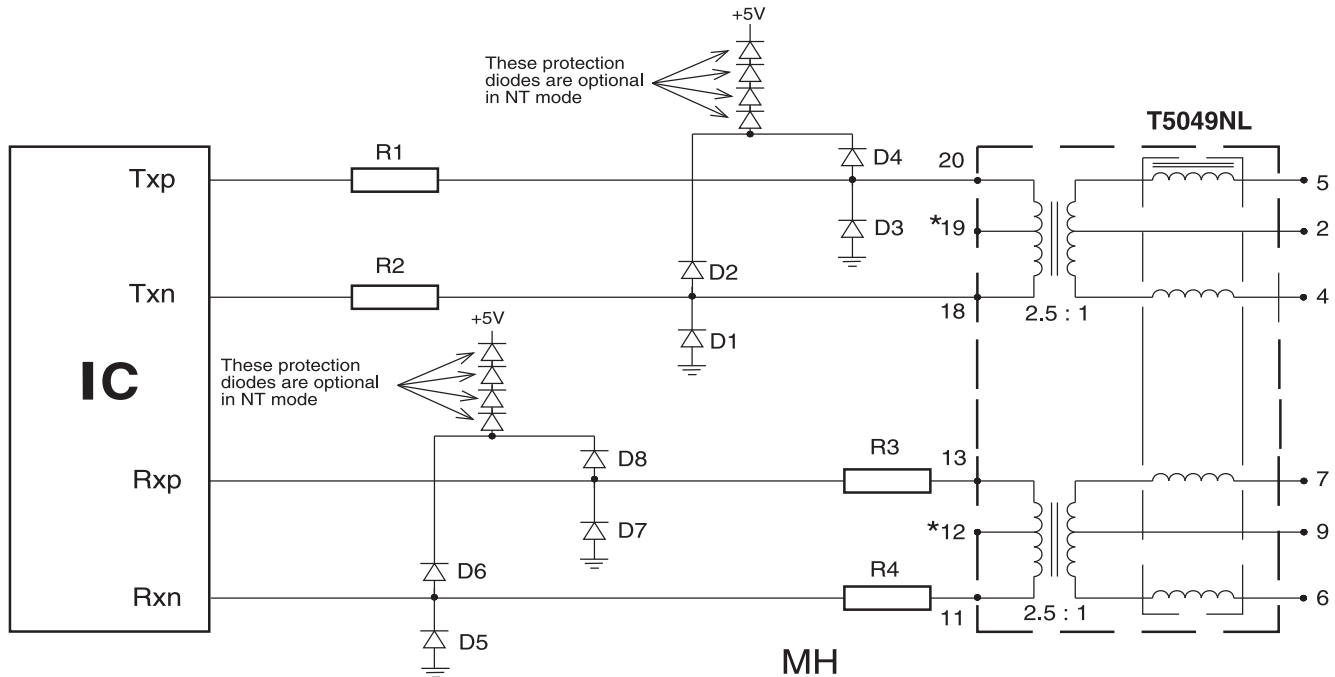

***NOTE:** Refer to Silicon Vendors' Application Notes for more details on power supply connection and specific component values.

Common Mode Choke Performance

Typical Common Mode Attenuation for the high-frequency Common Mode Choke (470 μ H) based on a 50 Ω system.

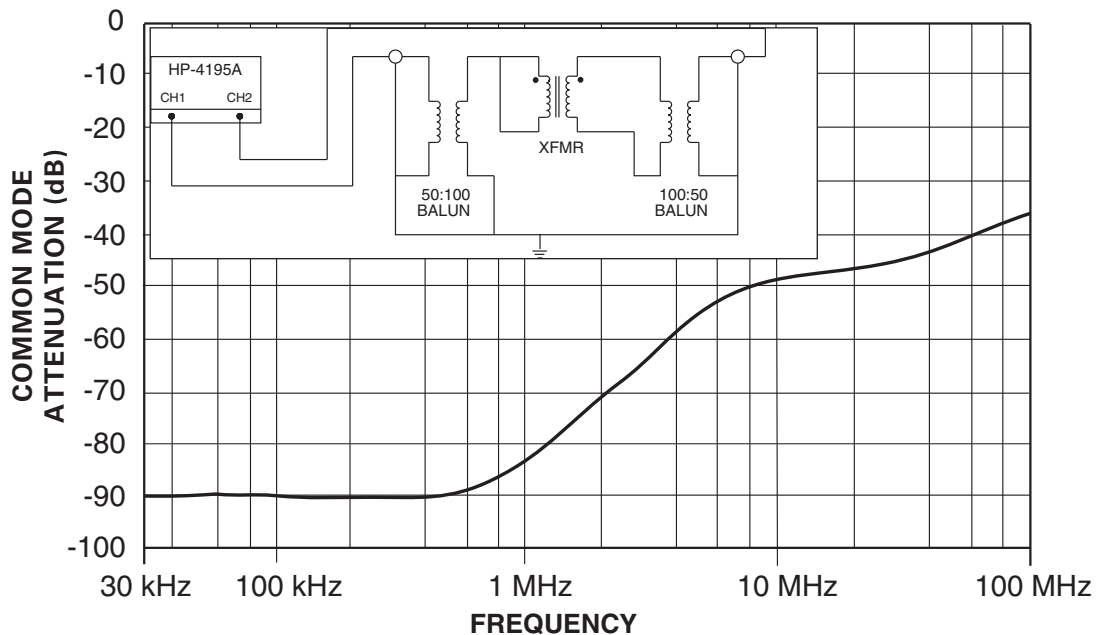

ISDN S-INTERFACE MODULES

Surface Mount, Dual, 1500 Vrms



Common Mode Choke Performance (continued)

Typical Common Mode Attenuation for the low-frequency Common Mode Choke (4.7 mH), based on a 50 Ω system.

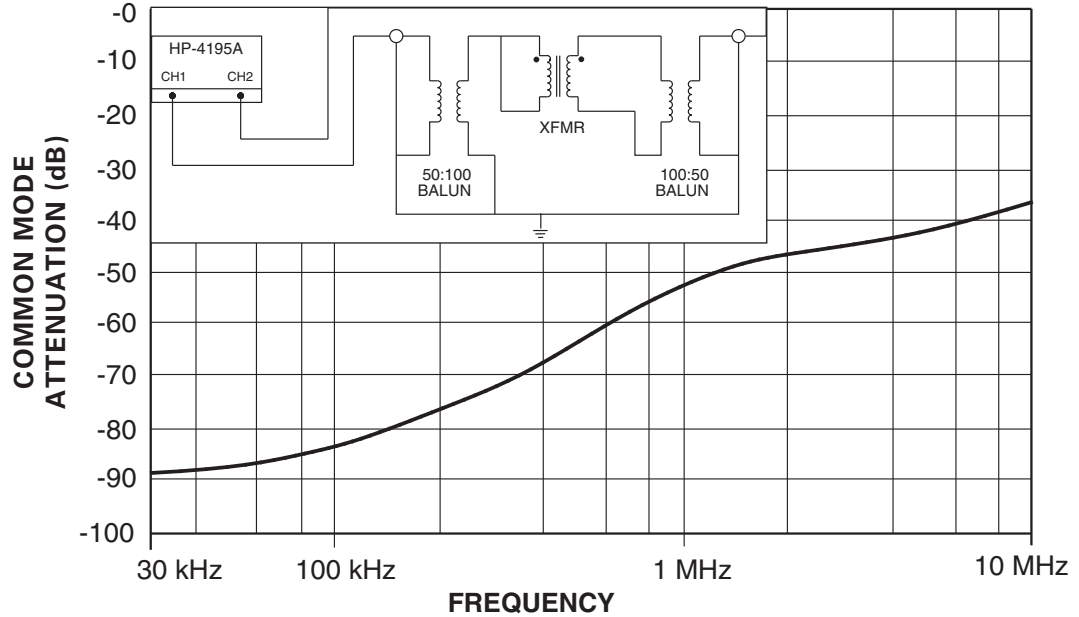

For More Information:

Pulse Worldwide Headquarters

12220 World Trade Dr.
San Diego, CA 92128
U.S.A.

www.pulseeng.com

Tel: 858 674 8100
Fax: 858 674 8262

Pulse Europe

Einsteinstrasse 1
D-71083 Herrenberg
Germany

Tel: 49 7032 7806 0
Fax: 49 7032 7806 135

Pulse China Headquarters

B402, Shenzhen Academy of
Aerospace Technology Bldg.
10th Kejinan Rd.
High-Tech Zone
Nanshan District
Shenzen, PR China 518057

Tel: 86 755 33966678
Fax: 86 755 33966700

Pulse North China

Room 2704/2705
Super Ocean Finance Ctr.
2067 Yan An Rd. West
Shanghai 200336
China

Tel: 86 21 62787060
Fax: 86 2162786973

Pulse South Asia

135 Joo Seng Rd.
#03-02
PM Industrial Bld g.
Singapore 368363

Tel: 65 6287 8998
Fax: 65 6287 8998

Pulse North Asia

3F, No. 198
Zhongyuan Rd.
Zhongli City
Taoyuan County 320
Taiwan R. O. C.

Tel: 886 3 4356768
Fax: 886 3 4356823 (Pulse)
Fax: 886 3 4356820 (FRE)

Performance warranty of products offered on this data sheet is limited to the parameters specified. Data is subject to change without notice. Other brand and product names mentioned herein may be trademarks or registered trademarks of their respective owners.

© Copyright, 2010. Pulse Engineering, Inc. All rights reserved.

Looking for pricing, stock, or lifecycle information?

Click below to explore more details on WIN SOURCE:

 [View T5049NL on WIN SOURCE](#)

 [Pulse Information](#)

Optimize Your Supply Chain with WIN SOURCE Solutions

-  Global Sourcing Solution
-  Obsolete Management
-  Cost Control Management
-  Shortage Management
-  Alternative Solution
-  Excess Inventory Management