



Is Now Part of



**ON Semiconductor®**

To learn more about ON Semiconductor, please visit our website at  
[www.onsemi.com](http://www.onsemi.com)

Please note: As part of the Fairchild Semiconductor integration, some of the Fairchild orderable part numbers will need to change in order to meet ON Semiconductor's system requirements. Since the ON Semiconductor product management systems do not have the ability to manage part nomenclature that utilizes an underscore (\_), the underscore (\_) in the Fairchild part numbers will be changed to a dash (-). This document may contain device numbers with an underscore (\_). Please check the ON Semiconductor website to verify the updated device numbers. The most current and up-to-date ordering information can be found at [www.onsemi.com](http://www.onsemi.com). Please email any questions regarding the system integration to [Fairchild\\_questions@onsemi.com](mailto:Fairchild_questions@onsemi.com).

ON Semiconductor and the ON Semiconductor logo are trademarks of Semiconductor Components Industries, LLC dba ON Semiconductor or its subsidiaries in the United States and/or other countries. ON Semiconductor owns the rights to a number of patents, trademarks, copyrights, trade secrets, and other intellectual property. A listing of ON Semiconductor's product/patent coverage may be accessed at [www.onsemi.com/site/pdf/Patent-Marking.pdf](http://www.onsemi.com/site/pdf/Patent-Marking.pdf). ON Semiconductor reserves the right to make changes without further notice to any products herein. ON Semiconductor makes no warranty, representation or guarantee regarding the suitability of its products for any particular purpose, nor does ON Semiconductor assume any liability arising out of the application or use of any product or circuit, and specifically disclaims any and all liability, including without limitation special, consequential or incidental damages. Buyer is responsible for its products and applications using ON Semiconductor products, including compliance with all laws, regulations and safety requirements or standards, regardless of any support or applications information provided by ON Semiconductor. "Typical" parameters which may be provided in ON Semiconductor data sheets and/or specifications can and do vary in different applications and actual performance may vary over time. All operating parameters, including "Typicals" must be validated for each customer application by customer's technical experts. ON Semiconductor does not convey any license under its patent rights nor the rights of others. ON Semiconductor products are not designed, intended, or authorized for use as a critical component in life support systems or any FDA Class 3 medical devices or medical devices with a same or similar classification in a foreign jurisdiction or any devices intended for implantation in the human body. Should Buyer purchase or use ON Semiconductor products for any such unintended or unauthorized application, Buyer shall indemnify and hold ON Semiconductor and its officers, employees, subsidiaries, affiliates, and distributors harmless against all claims, costs, damages, and expenses, and reasonable attorney fees arising out of, directly or indirectly, any claim of personal injury or death associated with such unintended or unauthorized use, even if such claim alleges that ON Semiconductor was negligent regarding the design or manufacture of the part. ON Semiconductor is an Equal Opportunity/Affirmative Action Employer. This literature is subject to all applicable copyright laws and is not for resale in any manner.

## 74VHC04 Hex Inverter

### Features

- High Speed:  $t_{PD} = 3.8\text{ns}$  (typ.) at  $V_{CC} = 5\text{V}$
- High noise immunity:  $V_{NIH} = V_{NIL} = 28\% V_{CC}$  (min.)
- Power down protection is provided on all inputs
- Low Noise:  $V_{OLP} = 0.4\text{V}$  (typ.)
- Low power dissipation:  $I_{CC} = 2\mu\text{A}$  (max.) @  $T_A = 25^\circ\text{C}$
- Pin and function compatible with 74HC04

### General Description

The VHC04 is an advanced high speed CMOS Inverter fabricated with silicon gate CMOS technology. It achieves the high speed operation similar to equivalent Bipolar Schottky TTL while maintaining the CMOS low power dissipation.

The internal circuit is composed of 3 stages including buffer output, which provide high noise immunity and stable output. An input protection circuit ensures that 0V to 7V can be applied to the input pins without regard to the supply voltage. This device can be used to interface 5V to 3V systems and two supply systems such as battery back up. This circuit prevents device destruction due to mismatched supply and input voltages.

### Ordering Information

| Order Number | Package Number | Package Description  |
|--------------|----------------|--|
| 74VHC04M     | M14A           | 14-Lead Small Outline Integrated Circuit (SOIC), JEDEC MS-012, 0.150" Narrow |
| 74VHC04SJ    | M14D           | 14-Lead Small Outline Package (SOP), EIAJ TYPE II, 5.3mm Wide                |
| 74VHC04MTC   | MTC14          | 14-Lead Thin Shrink Small Outline Package (TSSOP), JEDEC MO-153, 4.4mm Wide  |
| 74VHC04N     | N14A           | 14-Lead Plastic Dual-In-Line Package (PDIP), JEDEC MS-001, 0.300" Wide       |

Device also available in Tape and Reel. Specify by appending suffix letter "X" to the ordering number.

 All packages are lead free per JEDEC: J-STD-020B standard.

### Connection Diagram

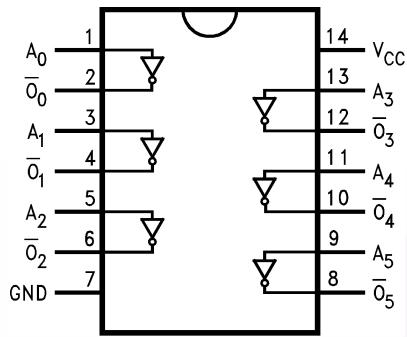

### Logic Symbol

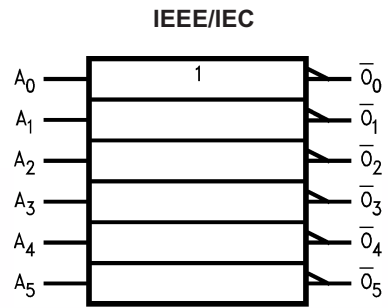

### Pin Description

| Pin Names   | Description |
|-------------|-------------|
| $A_n$       | Inputs      |
| $\bar{O}_n$ | Outputs     |

### Truth Table

| A | $\bar{O}$ |
|---|-----------|
| L | H         |
| H | L         |

## Absolute Maximum Ratings

Stresses exceeding the absolute maximum ratings may damage the device. The device may not function or be operable above the recommended operating conditions and stressing the parts to these levels is not recommended. In addition, extended exposure to stresses above the recommended operating conditions may affect device reliability. The absolute maximum ratings are stress ratings only.

| Symbol    | Parameter                                | Rating                   |
|-----------|--|--------------------------|
| $V_{CC}$  | Supply Voltage                           | -0.5V to +7.0V           |
| $V_{IN}$  | DC Input Voltage                         | -0.5V to +7.0V           |
| $V_{OUT}$ | DC Output Voltage                        | -0.5V to $V_{CC} + 0.5V$ |
| $I_{IK}$  | Input Diode Current                      | -20mA                    |
| $I_{OK}$  | Output Diode Current                     | $\pm 20mA$               |
| $I_{OUT}$ | DC Output Current                        | $\pm 25mA$               |
| $I_{CC}$  | DC $V_{CC}/GND$ Current                  | $\pm 50mA$               |
| $T_{STG}$ | Storage Temperature                      | -65°C to +150°C          |
| $T_L$     | Lead Temperature (Soldering, 10 seconds) | 260°C                    |

## Recommended Operating Conditions<sup>(1)</sup>

The Recommended Operating Conditions table defines the conditions for actual device operation. Recommended operating conditions are specified to ensure optimal performance to the datasheet specifications. Fairchild does not recommend exceeding them or designing to absolute maximum ratings.

| Symbol     | Parameter   | Rating                            |
|------------|---|-----------------------------------|
| $V_{CC}$   | Supply Voltage  | 2.0V to +5.5V                     |
| $V_{IN}$   | Input Voltage   | 0V to +5.5V                       |
| $V_{OUT}$  | Output Voltage  | 0V to $V_{CC}$                    |
| $T_{OPR}$  | Operating Temperature   | -40°C to +85°C                    |
| $t_r, t_f$ | Input Rise and Fall Time,<br>$V_{CC} = 3.3V \pm 0.3V$<br>$V_{CC} = 5.0V \pm 0.5V$ | 0ns/V ~ 100ns/V<br>0ns/V ~ 20ns/V |

### Note:

1. Unused inputs must be held HIGH or LOW. They may not float.

## DC Electrical Characteristics

| Symbol          | Parameter                 | V <sub>CC</sub> (V) | Conditions  | T <sub>A</sub> = 25°C   |      |                       | T <sub>A</sub> = -40°C to +85°C |                       | Units |   |
|-----------------|---------------------------|---------------------|---|-------------------------|------|-----------------------|---------------------------------|-----------------------|-------|---|
|                 |                           |                     |   | Min.                    | Typ. | Max.                  | Min.                            | Max.                  |       |   |
| V <sub>IH</sub> | HIGH Level Input Voltage  | 2.0                 |   | 1.50                    |      |                       | 1.50                            |                       | V     |   |
|                 |                           | 3.0–5.5             |   | 0.7 x V <sub>CC</sub>   |      |                       | 0.7 x V <sub>CC</sub>           |                       |       |   |
| V <sub>IL</sub> | LOW Level Input Voltage   | 2.0                 |   |                         |      | 0.50                  |                                 | 0.50                  | V     |   |
|                 |                           | 3.0–5.5             |   |                         |      | 0.3 x V <sub>CC</sub> |                                 | 0.3 x V <sub>CC</sub> |       |   |
| V <sub>OH</sub> | HIGH Level Output Voltage | 2.0                 | V <sub>IN</sub> = V <sub>IH</sub><br>or V <sub>IL</sub> | I <sub>OH</sub> = -50μA | 1.9  | 2.0                   |                                 | 1.9                   |       | V |
|                 |                           | 3.0                 |   |                         | 2.9  | 3.0                   |                                 | 2.9                   |       |   |
|                 |                           | 4.5                 |   |                         | 4.4  | 4.5                   |                                 | 4.4                   |       |   |
|                 |                           | 3.0                 |   | I <sub>OH</sub> = -4mA  | 2.58 |                       |                                 | 2.48                  |       |   |
|                 |                           | 4.5                 |   | I <sub>OH</sub> = -8mA  | 3.94 |                       |                                 | 3.80                  |       |   |
| V <sub>OL</sub> | LOW Level Output Voltage  | 2.0                 | V <sub>IN</sub> = V <sub>IH</sub><br>or V <sub>IL</sub> | I <sub>OL</sub> = 50μA  |      | 0.0                   | 0.1                             |                       | 0.1   | V |
|                 |                           | 3.0                 |   |                         |      | 0.0                   | 0.1                             |                       | 0.1   |   |
|                 |                           | 4.5                 |   |                         |      | 0.0                   | 0.1                             |                       | 0.1   |   |
|                 |                           | 3.0                 |   | I <sub>OL</sub> = 4mA   |      |                       | 0.36                            |                       | 0.44  |   |
|                 |                           | 4.5                 |   | I <sub>OL</sub> = 8mA   |      |                       | 0.36                            |                       | 0.44  |   |
| I <sub>IN</sub> | Input Leakage Current     | 0–5.5               | V <sub>IN</sub> = 5.5V or GND                           |                         |      | ±0.1                  |                                 | ±1.0                  | μA    |   |
| I <sub>CC</sub> | Quiescent Supply Current  | 5.5                 | V <sub>IN</sub> = V <sub>CC</sub> or GND                |                         |      | 2.0                   |                                 | 20.0                  | μA    |   |

## Noise Characteristics

| Symbol                          | Parameter                                    | V <sub>CC</sub> (V) | Conditions            | T <sub>A</sub> = 25°C |        | Units |
|---------------------------------|--|---------------------|-----------------------|-----------------------|--------|-------|
|                                 |  |                     |                       | Typ.                  | Limits |       |
| V <sub>OLP</sub> <sup>(2)</sup> | Quiet Output Maximum Dynamic V <sub>OL</sub> | 5.0                 | C <sub>L</sub> = 50pF | 0.4                   | 0.8    | V     |
| V <sub>OLV</sub> <sup>(2)</sup> | Quiet Output Minimum Dynamic V <sub>OL</sub> | 5.0                 | C <sub>L</sub> = 50pF | -0.4                  | -0.8   | V     |
| V <sub>IHD</sub> <sup>(2)</sup> | Minimum HIGH Level Dynamic Input Voltage     | 5.0                 | C <sub>L</sub> = 50pF |                       | 3.5    | V     |
| V <sub>ILD</sub> <sup>(2)</sup> | Maximum LOW Level Dynamic Input Voltage      | 5.0                 | C <sub>L</sub> = 50pF |                       | 1.5    | V     |

**Note:**

2. Parameter guaranteed by design.

## AC Electrical Characteristics

| Symbol                              | Parameter                     | V <sub>CC</sub> (V) | Conditions             | T <sub>A</sub> = 25°C |      |      | T <sub>A</sub> = -40°C to +85°C |      | Units |
|-------------------------------------|-------------------------------|---------------------|------------------------|-----------------------|------|------|---------------------------------|------|-------|
|                                     |                               |                     |                        | Min.                  | Typ. | Max. | Min.                            | Max. |       |
| t <sub>PHL</sub> , t <sub>PLH</sub> | Propagation Delay             | 3.3 ± 0.3           | C <sub>L</sub> = 15 pF |                       | 5.0  | 7.1  | 1.0                             | 8.5  | ns    |
|                                     |                               |                     | C <sub>L</sub> = 50 pF |                       | 7.5  | 10.6 | 1.0                             | 12.0 |       |
|                                     |                               | 5.0 ± 0.5           | C <sub>L</sub> = 15 pF |                       | 3.8  | 5.5  | 1.0                             | 6.5  | ns    |
|                                     |                               |                     | C <sub>L</sub> = 50 pF |                       | 5.3  | 7.5  | 1.0                             | 8.5  |       |
| C <sub>IN</sub>                     | Input Capacitance             |                     | V <sub>CC</sub> = OPEN |                       | 4    | 10   |                                 | 10   | pF    |
| C <sub>PD</sub>                     | Power Dissipation Capacitance |                     | (3)                    |                       | 18   |      |                                 |      | pF    |

**Note:**

3. C<sub>PD</sub> is defined as the value of the internal equivalent capacitance which is calculated from the operating current consumption without load. Average operating current can be obtained by the equation:

$$I_{CC}(\text{opr.}) = C_{PD} \cdot V_{CC} \cdot f_{IN} + I_{CC} / 6 \text{ (per gate).}$$

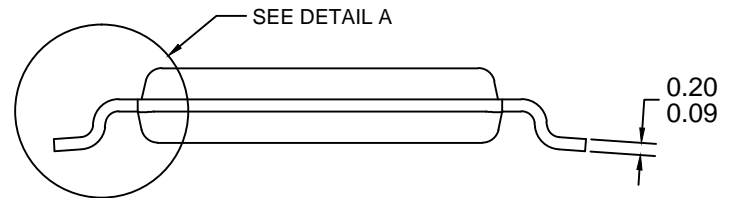

NOTES:

- A. CONFORMS TO JEDEC REGISTRATION MO-153, VARIATION AB, REF NOTE 6
- B. DIMENSIONS ARE IN MILLIMETERS.
- C. DIMENSIONS ARE EXCLUSIVE OF BURRS, MOLD FLASH, AND TIE BAR EXTRUSIONS
- D. DIMENSIONING AND TOLERANCES PER ANSI Y14.5M, 2009.
- E. LANDPATTERN STANDARD: SOP65P640X110-14M.
- F. DRAWING FILE NAME: MKT-MTC14rev7.



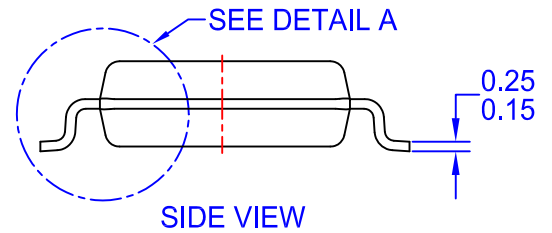
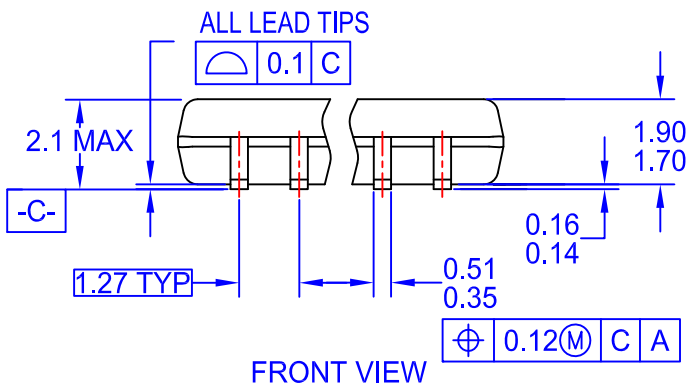

- NOTES:
- A. CONFORMS TO EIAJ EDR-7320 REGISTRATION, ESTABLISHED IN DECEMBER, 1998.
  - B. DIMENSIONS ARE IN MILLIMETERS.
  - C. DIMENSIONS ARE EXCLUSIVE OF BURRS, MOLD FLASH, AND TIE BAR EXTRUSIONS.
  - D. DRAWING FILENAME: MKT-M14Drev4.

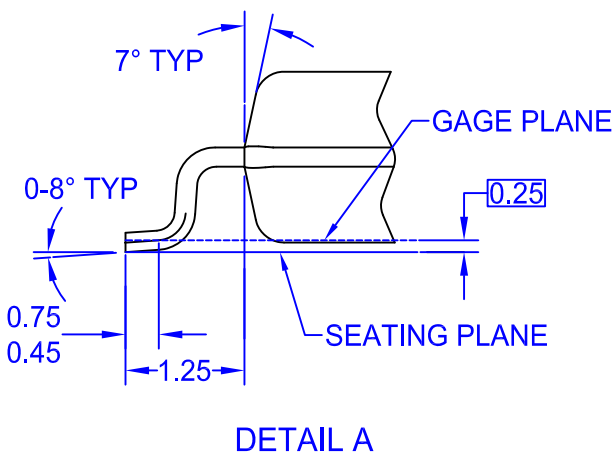

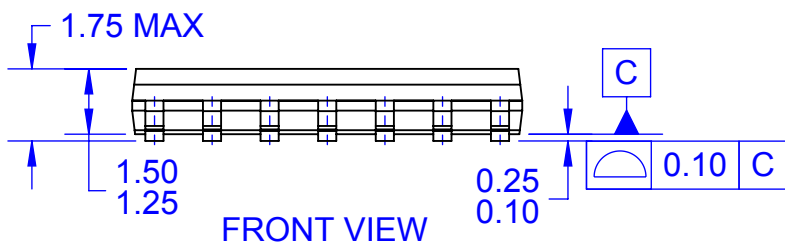
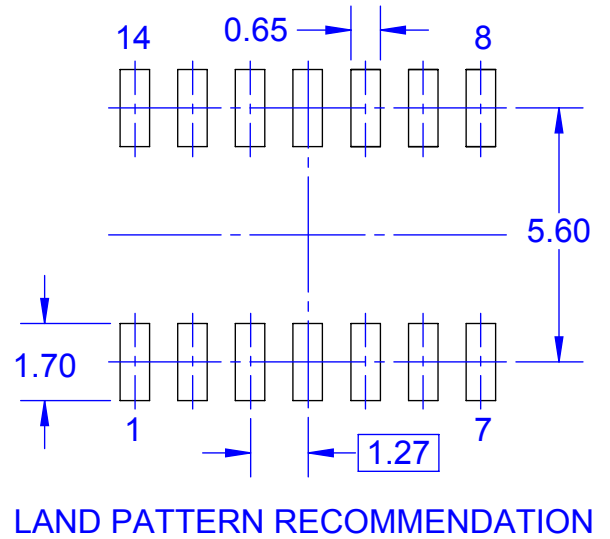
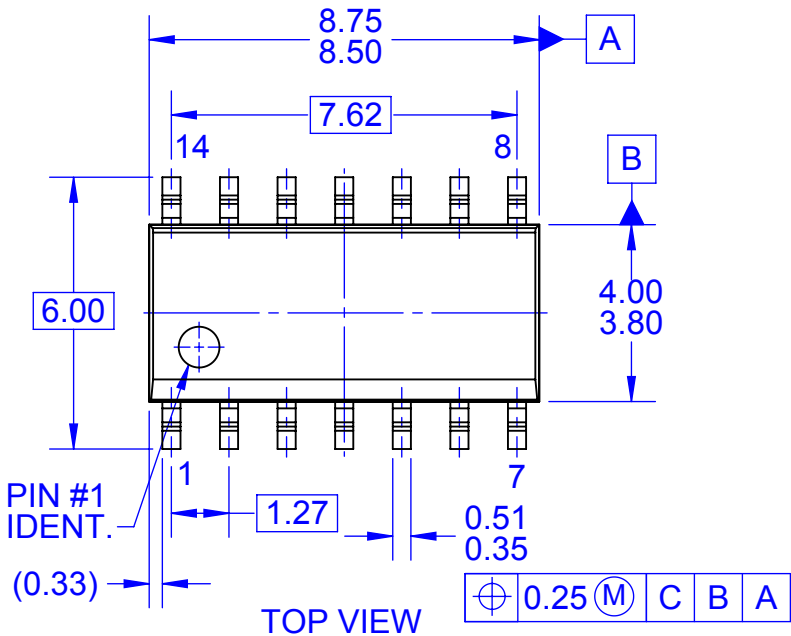

NOTES:

- A. CONFORMS TO JEDEC MS-012, VARIATION AB, ISSUE C
- B. ALL DIMENSIONS ARE IN MILLIMETERS
- C. DIMENSIONS DO NOT INCLUDE MOLD FLASH OR BURRS
- D. LAND PATTERN STANDARD: SOIC127P600X145-14M
- E. CONFORMS TO ASME Y14.5M, 2009
- D. DRAWING FILENAME: MKT-M14Arev14



ON Semiconductor and  are trademarks of Semiconductor Components Industries, LLC dba ON Semiconductor or its subsidiaries in the United States and/or other countries. ON Semiconductor owns the rights to a number of patents, trademarks, copyrights, trade secrets, and other intellectual property. A listing of ON Semiconductor's product/patent coverage may be accessed at [www.onsemi.com/site/pdf/Patent-Marking.pdf](http://www.onsemi.com/site/pdf/Patent-Marking.pdf). ON Semiconductor reserves the right to make changes without further notice to any products herein. ON Semiconductor makes no warranty, representation or guarantee regarding the suitability of its products for any particular purpose, nor does ON Semiconductor assume any liability arising out of the application or use of any product or circuit, and specifically disclaims any and all liability, including without limitation special, consequential or incidental damages. Buyer is responsible for its products and applications using ON Semiconductor products, including compliance with all laws, regulations and safety requirements or standards, regardless of any support or applications information provided by ON Semiconductor. "Typical" parameters which may be provided in ON Semiconductor data sheets and/or specifications can and do vary in different applications and actual performance may vary over time. All operating parameters, including "Typicals" must be validated for each customer application by customer's technical experts. ON Semiconductor does not convey any license under its patent rights nor the rights of others. ON Semiconductor products are not designed, intended, or authorized for use as a critical component in life support systems or any FDA Class 3 medical devices or medical devices with a same or similar classification in a foreign jurisdiction or any devices intended for implantation in the human body. Should Buyer purchase or use ON Semiconductor products for any such unintended or unauthorized application, Buyer shall indemnify and hold ON Semiconductor and its officers, employees, subsidiaries, affiliates, and distributors harmless against all claims, costs, damages, and expenses, and reasonable attorney fees arising out of, directly or indirectly, any claim of personal injury or death associated with such unintended or unauthorized use, even if such claim alleges that ON Semiconductor was negligent regarding the design or manufacture of the part. ON Semiconductor is an Equal Opportunity/Affirmative Action Employer. This literature is subject to all applicable copyright laws and is not for resale in any manner.

## PUBLICATION ORDERING INFORMATION

### LITERATURE FULFILLMENT:

Literature Distribution Center for ON Semiconductor  
19521 E. 32nd Pkwy, Aurora, Colorado 80011 USA  
**Phone:** 303-675-2175 or 800-344-3860 Toll Free USA/Canada  
**Fax:** 303-675-2176 or 800-344-3867 Toll Free USA/Canada  
**Email:** [orderlit@onsemi.com](mailto:orderlit@onsemi.com)

**N. American Technical Support:** 800-282-9855 Toll Free  
USA/Canada  
**Europe, Middle East and Africa Technical Support:**  
Phone: 421 33 790 2910  
**Japan Customer Focus Center**  
Phone: 81-3-5817-1050

**ON Semiconductor Website:** [www.onsemi.com](http://www.onsemi.com)  
**Order Literature:** <http://www.onsemi.com/orderlit>  
For additional information, please contact your local  
Sales Representative

## Looking for pricing, stock, or lifecycle information?

Click below to explore more details on WIN SOURCE:

- ⊖ [View 74VHC04MX on WIN SOURCE](#)
- ⊖ [Fairchild/ON Semiconductor Information](#)

## Optimize Your Supply Chain with WIN SOURCE Solutions

- ✓ Global Sourcing Solution
- ✓ Obsolete Management
- ✓ Cost Control Management
- ✓ Shortage Management
- ✓ Alternative Solution
- ✓ Excess Inventory Management