



**THE DATASHEET OF  
TC7WH08FU-TE12L**



TOSHIBA CMOS DIGITAL INTEGRATED CIRCUIT SILICON MONOLITHIC

# TC7WH08FU, TC7WH08FK

## DUAL 2-INPUT AND GATE

The TC7WH08 is an advanced high speed CMOS 2-INPUT AND GATE fabricated with silicon gate CMOS technology. It achieves the high speed operation similar to equivalent Bipolar Schottky TTL while maintaining the CMOS low power dissipation. The internal circuit is composed of 4 stages including buffer output, which provide high noise immunity and stable output. An input protection circuit ensures that 0 to 7V can be applied to the input pins without regard to the supply voltage. This device can be used to interface 5V to 3V systems and two supply systems such as battery back up. This circuit prevents device destruction due to mismatched supply and input voltages.

### FEATURES

- High Speed .....  $t_{pd} = 4.3ns$  (Typ.) at  $V_{CC} = 5V$
- Low Power Dissipation .....  $I_{CC} = 2\mu A$  (Max.) at  $T_a = 25^\circ C$
- High Noise Immunity .....  $V_{NIH} = V_{NIL} = 28\% V_{CC}$  (Min.)
- Power Down Protection is provided on all inputs.
- Balanced Propagation Delays .....  $t_{pLH} \approx t_{pHL}$
- Wide Operating Voltage Range ...  $V_{CC} (opr) = 2 \sim 5.5V$

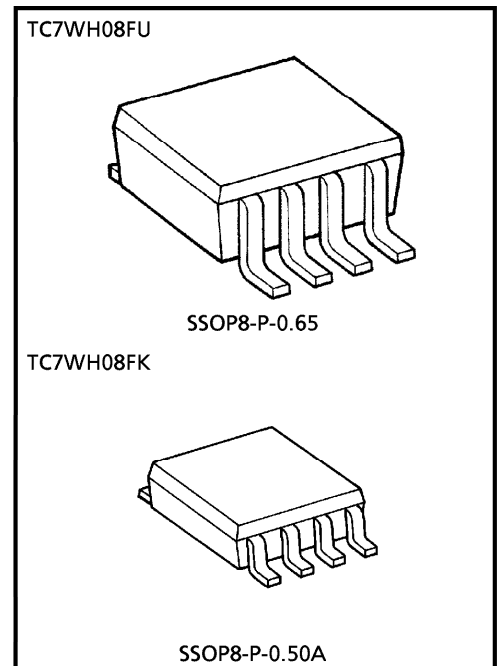

Weight  
 SSOP8-P-0.65 : 0.02g (Typ.)  
 SSOP8-P-0.50A : 0.01g (Typ.)

### MARKING

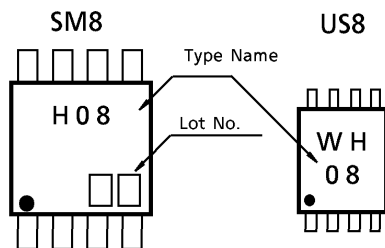

### PIN ASSIGNMENT (TOP VIEW)

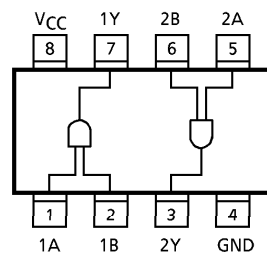

**MAXIMUM RATINGS (Ta = 25°C)**

CHARACTERISTIC	SYMBOL	RATING	UNIT
Supply Voltage Range	V <sub>CC</sub>	-0.5~7.0	V
DC Input Voltage	V <sub>IN</sub>	-0.5~7.0	V
DC Output Voltage	V <sub>OUT</sub>	-0.5~V <sub>CC</sub> +0.5	V
Input Diode Current	I <sub>IK</sub>	-20	mA
Output Diode Current	I <sub>OK</sub>	±20	mA
DC Output Current	I <sub>OUT</sub>	±25	mA
DC V <sub>CC</sub> /Ground Current	I <sub>CC</sub>	±50	mA
Power Dissipation	P <sub>D</sub>	300 (SM8)	mW
		200 (US8)	
Storage Temperature	T <sub>stg</sub>	-65~150	°C
Lead Temperature (10 s)	T <sub>L</sub>	260	°C

**LOGIC DIAGRAM**

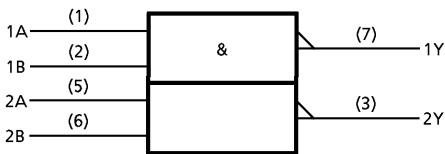

**TRUTH TABLE**

A	B	Y
L	L	L
L	H	L
H	L	L
H	H	H

**RECOMMENDED OPERATING CONDITIONS**

CHARACTERISTIC	SYMBOL	RATING	UNIT
Supply Voltage	V <sub>CC</sub>	2.0~5.5	V
Input Voltage	V <sub>IN</sub>	0~5.5	V
Output Voltage	V <sub>OUT</sub>	0~V <sub>CC</sub>	V
Operating Temperature	T <sub>opr</sub>	-40~85	°C
Input Rise and Fall Time	dt / dv	0~100 (V <sub>CC</sub> = 3.3 ± 0.3V)	ns / V
		0~20 (V <sub>CC</sub> = 5 ± 0.5V)	

## DC ELECTRICAL CHARACTERISTICS

CHARACTERISTIC	SYMBOL	TEST CONDITION	V <sub>CC</sub> (V)	Ta = 25°C			Ta = -40~85°C		UNIT	
				MIN.	TYP.	MAX.	MIN.	MAX.		
High-Level Input Voltage	V <sub>IH</sub>	—	2.0	1.50	—	—	1.50	—	V	
			3.0~5.5	V <sub>CC</sub> × 0.7	—	—	V <sub>CC</sub> × 0.7	—		
Low-Level Input Voltage	V <sub>IL</sub>	—	2.0	—	—	0.50	—	0.50	V	
			3.0~5.5	—	—	V <sub>CC</sub> × 0.3	—	V <sub>CC</sub> × 0.3		
High-Level Output Voltage	V <sub>OH</sub>	V <sub>IN</sub> = V <sub>IH</sub>	I <sub>OH</sub> = -50 μA	2.0	1.9	2.0	—	1.9	—	V
				3.0	2.9	3.0	—	2.9	—	
				4.5	4.4	4.5	—	4.4	—	
			I <sub>OH</sub> = -4mA	3.0	2.58	—	—	2.48	—	
4.5	3.94	—		—	3.80	—				
Low-Level Output Voltage	V <sub>OL</sub>	V <sub>IN</sub> = V <sub>IH</sub> or V <sub>IL</sub>	I <sub>OL</sub> = 50 μA	2.0	—	0.0	0.1	—	0.1	V
				3.0	—	0.0	0.1	—	0.1	
				4.5	—	0.0	0.1	—	0.1	
			I <sub>OL</sub> = 4mA	3.0	—	—	0.36	—	0.44	
				4.5	—	—	0.36	—	0.44	
Input Leakage Current	I <sub>IN</sub>	V <sub>IN</sub> = 5.5V or GND	0~5.5	—	—	±0.1	—	±1.0	μA	
Quiescent Supply Current	I <sub>CC</sub>	V <sub>IN</sub> = V <sub>CC</sub> or GND	5.5	—	—	2.0	—	20.0	μA	

**AC ELECTRICAL CHARACTERISTICS** (Input  $t_r = t_f = 3\text{ns}$ )

CHARACTERISTIC	SYMBOL	TEST CONDITION	Ta = 25°C			Ta = -40~85°C		UNIT		
			V <sub>CC</sub> (V)	C <sub>L</sub> (pF)	MIN.	TYP.	MAX.		MIN.	MAX.
Propagation Delay Time	t <sub>pLH</sub>	—	3.3 ± 0.3	15	—	6.2	8.8	1.0	10.5	ns
				50	—	8.7	12.3	1.0	14.0	
	t <sub>pHL</sub>		5.0 ± 0.5	15	—	4.3	5.9	1.0	7.0	
				50	—	5.8	7.9	1.0	9.0	
Input Capacitance	C <sub>IN</sub>	—	—	4	10	—	10	pF		
Power Dissipation Capacitance	C <sub>PD</sub>	(Note 1)	—	18	—	—	—	pF		

(Note 1) : C<sub>PD</sub> is defined as the value of the internal equivalent capacitance which is calculated from the operating current consumption without load.

Average operating current can be obtained by the equation :

$$I_{CC(opr)} = C_{PD} \cdot V_{CC} \cdot f_{IN} + I_{CC}$$

**NOISE CHARACTERISTICS** (Ta = 25°C, Input  $t_r = t_f = 3\text{ns}$ )

CHARACTERISTIC	SYMBOL	TEST CONDITION	V <sub>CC</sub> (V)	TYP.	LIMIT	UNIT
Quiet Output Maximum Dynamic V <sub>OL</sub>	V <sub>OLP</sub>	C <sub>L</sub> = 50pF	5.0	0.3	0.8	V
Quiet Output Minimum Dynamic V <sub>OL</sub>	V <sub>OLV</sub>	C <sub>L</sub> = 50pF	5.0	-0.3	-0.8	V
Minimum High Level Dynamic Input Voltage	V <sub>IHD</sub>	C <sub>L</sub> = 50pF	5.0	—	3.5	V
Maximum Low Level Dynamic Input Voltage	V <sub>I LD</sub>	C <sub>L</sub> = 50pF	5.0	—	1.5	V

**INPUT EQUIVALENT CIRCUIT**

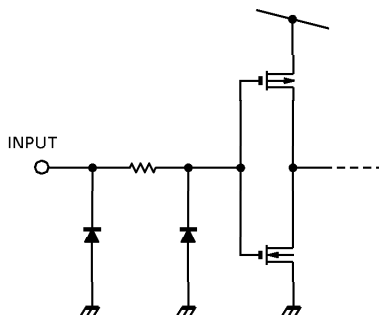

PACKAGE DIMENSIONS  
SSOP8-P-0.65

Unit : mm

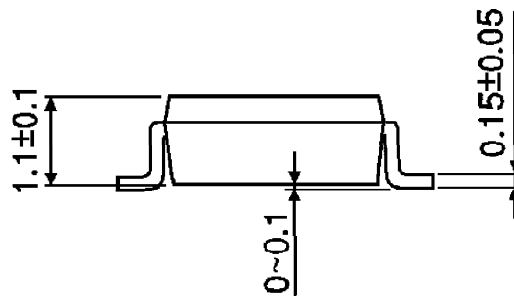
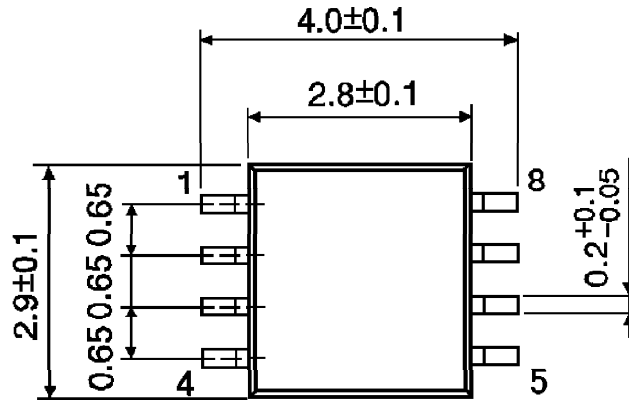

Weight : 0.02g (Typ.)

PACKAGE DIMENSIONS  
SSOP8-P-0.50A

Unit : mm

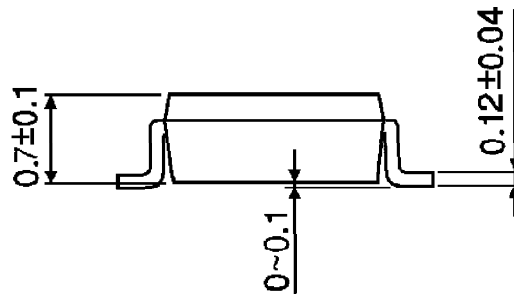
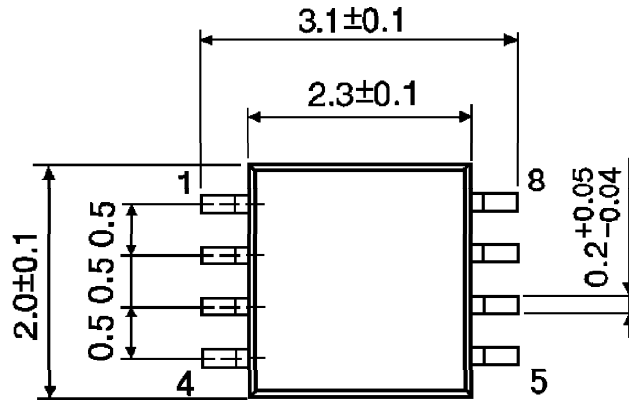

Weight : 0.01g (Typ.)



**RESTRICTIONS ON PRODUCT USE**

000707EBA

- TOSHIBA is continually working to improve the quality and reliability of its products. Nevertheless, semiconductor devices in general can malfunction or fail due to their inherent electrical sensitivity and vulnerability to physical stress. It is the responsibility of the buyer, when utilizing TOSHIBA products, to comply with the standards of safety in making a safe design for the entire system, and to avoid situations in which a malfunction or failure of such TOSHIBA products could cause loss of human life, bodily injury or damage to property. In developing your designs, please ensure that TOSHIBA products are used within specified operating ranges as set forth in the most recent TOSHIBA products specifications. Also, please keep in mind the precautions and conditions set forth in the "Handling Guide for Semiconductor Devices," or "TOSHIBA Semiconductor Reliability Handbook" etc..
- The TOSHIBA products listed in this document are intended for usage in general electronics applications (computer, personal equipment, office equipment, measuring equipment, industrial robotics, domestic appliances, etc.). These TOSHIBA products are neither intended nor warranted for usage in equipment that requires extraordinarily high quality and/or reliability or a malfunction or failure of which may cause loss of human life or bodily injury ("Unintended Usage"). Unintended Usage include atomic energy control instruments, airplane or spaceship instruments, transportation instruments, traffic signal instruments, combustion control instruments, medical instruments, all types of safety devices, etc.. Unintended Usage of TOSHIBA products listed in this document shall be made at the customer's own risk.
- The products described in this document are subject to the foreign exchange and foreign trade laws.
- The information contained herein is presented only as a guide for the applications of our products. No responsibility is assumed by TOSHIBA CORPORATION for any infringements of intellectual property or other rights of the third parties which may result from its use. No license is granted by implication or otherwise under any intellectual property or other rights of TOSHIBA CORPORATION or others.
- The information contained herein is subject to change without notice.

## Looking for pricing, stock, or lifecycle information?

Click below to explore more details on WIN SOURCE:

-  [View TC7WH08FU-TE12L on WIN SOURCE](#)
-  [Toshiba Semiconductor and Storage Information](#)

## Optimize Your Supply Chain with WIN SOURCE Solutions

-  Global Sourcing Solution
-  Obsolete Management
-  Cost Control Management
-  Shortage Management
-  Alternative Solution
-  Excess Inventory Management