



# THE DATASHEET OF TIP32CTU



# TIP31, TIP31A, TIP31B, TIP31C, (NPN), TIP32, TIP32A, TIP32B, TIP32C, (PNP)



ON Semiconductor®

<http://onsemi.com>

## Complementary Silicon Plastic Power Transistors

Designed for use in general purpose amplifier and switching applications.

- Collector-Emitter Saturation Voltage -  
 $V_{CE(sat)} = 1.2 \text{ Vdc (Max) @ } I_C = 3.0 \text{ Adc}$
- Collector-Emitter Sustaining Voltage -  
 $V_{CEO(sus)} = 40 \text{ Vdc (Min) - TIP31, TIP32}$   
 $= 60 \text{ Vdc (Min) - TIP31A, TIP32A}$   
 $= 80 \text{ Vdc (Min) - TIP31B, TIP32B}$   
 $= 100 \text{ Vdc (Min) - TIP31C, TIP32C}$
- High Current Gain - Bandwidth Product  
 $f_T = 3.0 \text{ MHz (Min) @ } I_C = 500 \text{ mAdc}$
- Compact TO-220 AB Package

**3 AMPERE  
POWER TRANSISTORS  
COMPLEMENTARY  
SILICON  
40-60-80-100 VOLTS  
40 WATTS**

### MAXIMUM RATINGS

Rating	Symbol	Value	Unit
Collector-Emitter Voltage TIP31, TIP32 TIP31A, TIP32A TIP31B, TIP32B TIP31C, TIP32C	$V_{CEO}$	40 60 80 100	Vdc
Collector-Base Voltage TIP31, TIP32 TIP31A, TIP32A TIP31B, TIP32B TIP31C, TIP32C	$V_{CB}$	40 60 80 100	Vdc
Emitter-Base Voltage	$V_{EB}$	5.0	Vdc
Collector Current Continuous Peak	$I_C$	3.0 5.0	Adc
Base Current	$I_B$	1.0	Adc
Total Power Dissipation @ $T_C = 25^\circ\text{C}$ Derate above $25^\circ\text{C}$	$P_D$	40 0.32	Watts $\text{W}/^\circ\text{C}$
Total Power Dissipation @ $T_A = 25^\circ\text{C}$ Derate above $25^\circ\text{C}$	$P_D$	2.0 0.016	Watts $\text{W}/^\circ\text{C}$
Unclamped Inductive Load Energy (Note 1)	E	32	mJ
Operating and Storage Junction Temperature Range	$T_J, T_{stg}$	-65 to +150	$^\circ\text{C}$

1.  $I_C = 1.8 \text{ A}$ ,  $L = 20 \text{ mH}$ , P.R.F. = 10 Hz,  $V_{CC} = 10 \text{ V}$ ,  $R_{BE} = 100 \Omega$ .

### MARKING DIAGRAM

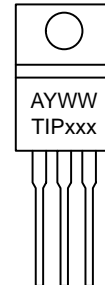
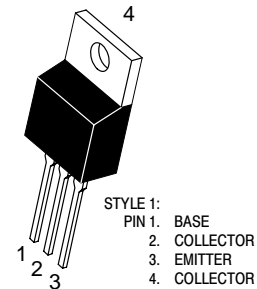

**TO-220AB  
CASE 221A-09  
STYLE 1**

xxx = Specific Device Code:  
31, 31A, 31B, 31C, 32, 32A, 32B, 32C  
A = Assembly Location  
Y = Year  
WW = Work Week

### ORDERING INFORMATION

See detailed ordering and shipping information in the package dimensions section on page 6 of this data sheet.

# TIP31, TIP31A, TIP31B, TIP31C, (NPN), TIP32, TIP32A, TIP32B, TIP32C, (PNP)

## THERMAL CHARACTERISTICS

Characteristic	Symbol	Max	Unit
Thermal Resistance, Junction to Ambient	$R_{\theta JA}$	62.5	$^{\circ}C/W$
Thermal Resistance, Junction to Case	$R_{\theta JC}$	3.125	$^{\circ}C/W$

## ELECTRICAL CHARACTERISTICS ( $T_C = 25^{\circ}C$ unless otherwise noted)

Characteristic	Symbol	Min	Max	Unit
----------------	--------	-----	-----	------

### OFF CHARACTERISTICS

Collector-Emitter Sustaining Voltage (Note 2) ( $I_C = 30$ mAdc, $I_B = 0$ )	TIP31, TIP32 TIP31A, TIP32A TIP31B, TIP32B TIP31C, TIP32C	$V_{CEO(sus)}$	40 60 80 100	- - - -	Vdc
Collector Cutoff Current ( $V_{CE} = 30$ Vdc, $I_B = 0$ ) ( $V_{CE} = 60$ Vdc, $I_B = 0$ )	TIP31, TIP32, TIP31A, TIP32A TIP31B, TIP31C, TIP32B, TIP32C	$I_{CEO}$	- -	0.3 0.3	mAdc
Collector Cutoff Current ( $V_{CE} = 40$ Vdc, $V_{EB} = 0$ ) ( $V_{CE} = 60$ Vdc, $V_{EB} = 0$ ) ( $V_{CE} = 80$ Vdc, $V_{EB} = 0$ ) ( $V_{CE} = 100$ Vdc, $V_{EB} = 0$ )	TIP31, TIP32 TIP31A, TIP32A TIP31B, TIP32B TIP31C, TIP32C	$I_{CES}$	- - - -	200 200 200 200	$\mu$ Adc
Emitter Cutoff Current ( $V_{BE} = 5.0$ Vdc, $I_C = 0$ )		$I_{EBO}$	-	1.0	mAdc

### ON CHARACTERISTICS (Note 2)

DC Current Gain ( $I_C = 1.0$ Adc, $V_{CE} = 4.0$ Vdc) ( $I_C = 3.0$ Adc, $V_{CE} = 4.0$ Vdc)		$h_{FE}$	25 10	- 50	-
Collector-Emitter Saturation Voltage ( $I_C = 3.0$ Adc, $I_B = 375$ mAdc)		$V_{CE(sat)}$	-	1.2	Vdc
Base-Emitter On Voltage ( $I_C = 3.0$ Adc, $V_{CE} = 4.0$ Vdc)		$V_{BE(on)}$	-	1.8	Vdc

### DYNAMIC CHARACTERISTICS

Current-Gain - Bandwidth Product ( $I_C = 500$ mAdc, $V_{CE} = 10$ Vdc, $f_{test} = 1.0$ MHz)		$f_T$	3.0	-	MHz
Small-Signal Current Gain ( $I_C = 0.5$ Adc, $V_{CE} = 10$ Vdc, $f = 1.0$ kHz)		$h_{fe}$	20	-	-

2. Pulse Test: Pulse Width  $\leq 300$   $\mu$ s, Duty Cycle  $\leq 2.0\%$ .

TIP31, TIP31A, TIP31B, TIP31C, (NPN), TIP32, TIP32A, TIP32B, TIP32C, (PNP)

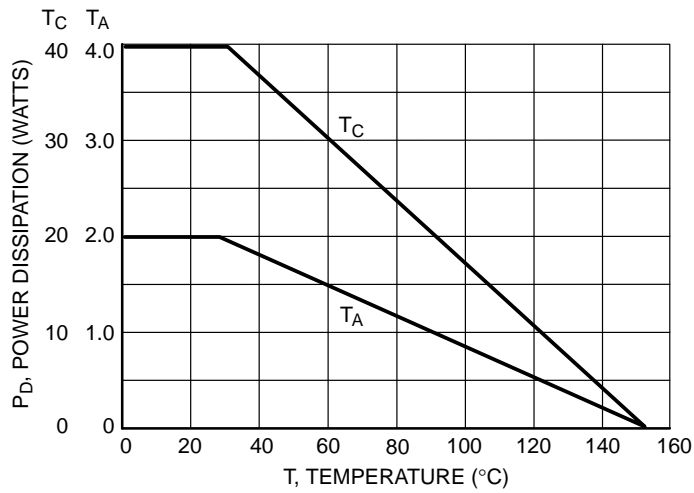
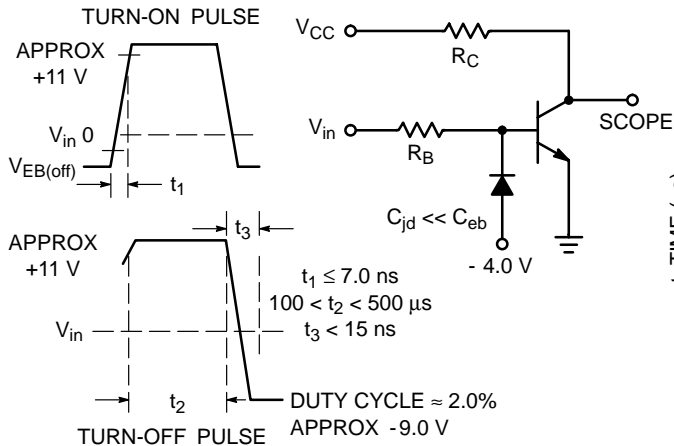

Figure 1. Power Derating



$R_B$  and  $R_C$  VARIED TO OBTAIN DESIRED CURRENT LEVELS.

Figure 2. Switching Time Equivalent Circuit

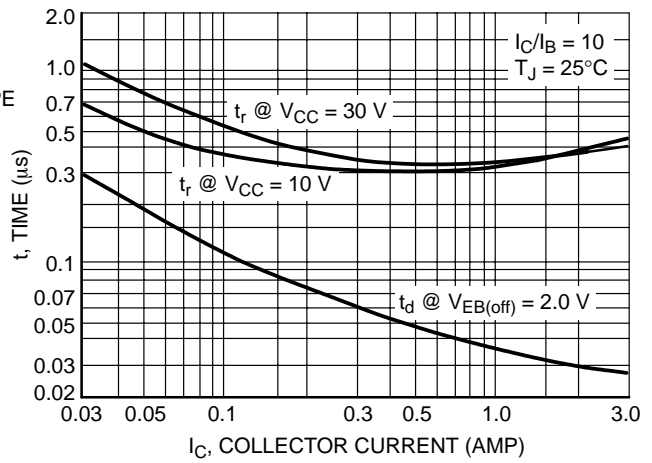

Figure 3. Turn-On Time

TIP31, TIP31A, TIP31B, TIP31C, (NPN), TIP32, TIP32A, TIP32B, TIP32C, (PNP)

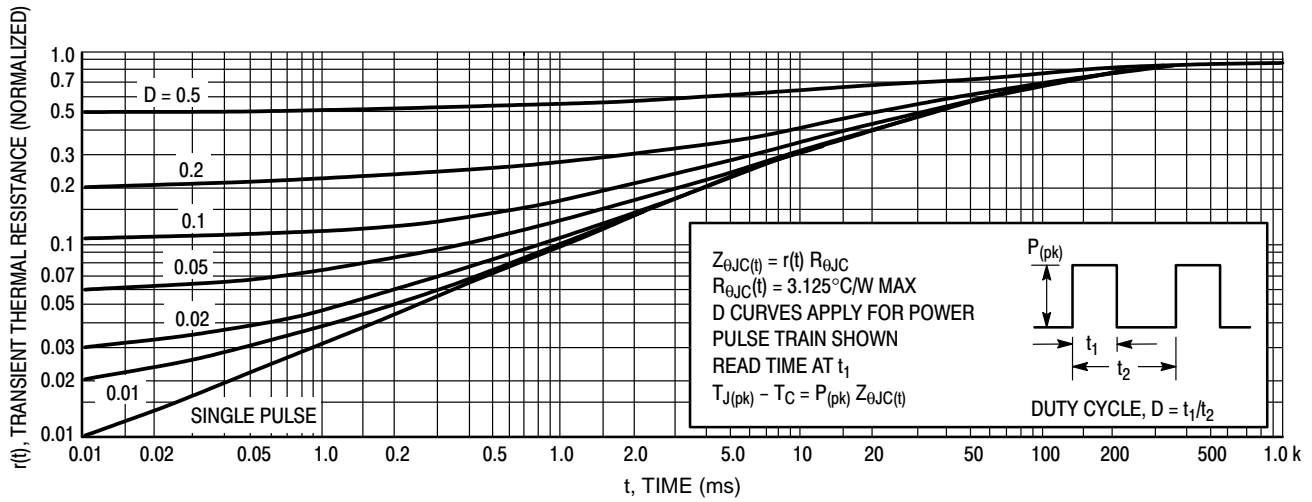

Figure 4. Thermal Response

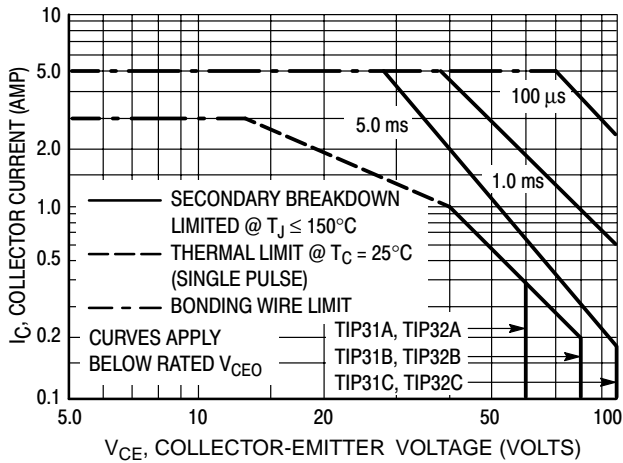

Figure 5. Active Region Safe Operating Area

There are two limitations on the power handling ability of a transistor: average junction temperature and second breakdown. Safe operating area curves indicate  $I_C - V_{CE}$  limits of the transistor that must be observed for reliable operation; i.e., the transistor must not be subjected to greater dissipation than the curves indicate.

The data of Figure 5 is based on  $T_{J(pk)} = 150^\circ\text{C}$ ;  $T_C$  is variable depending on conditions. Second breakdown pulse limits are valid for duty cycles to 10% provided  $T_{J(pk)} \leq 150^\circ\text{C}$ .  $T_{J(pk)}$  may be calculated from the data in Figure 4. At high case temperatures, thermal limitations will reduce the power that can be handled to values less than the limitations imposed by second breakdown.

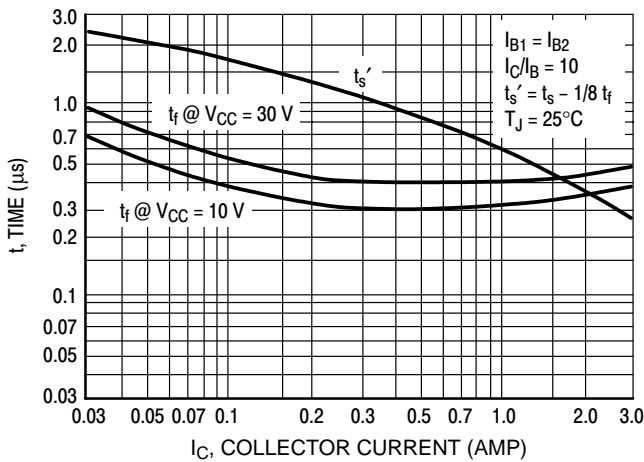

Figure 6. Turn-Off Time

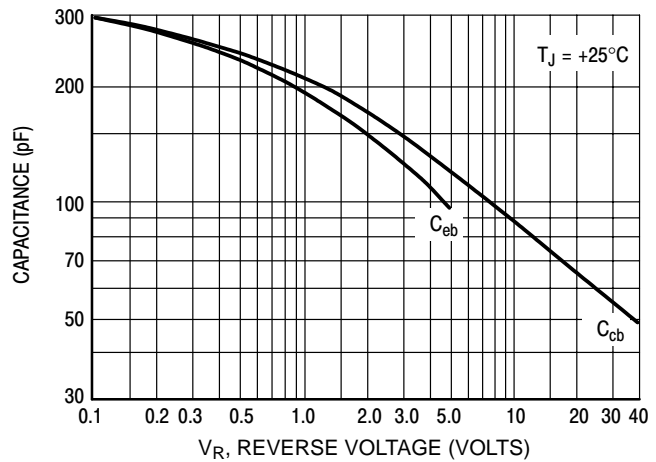

Figure 7. Capacitance

TIP31, TIP31A, TIP31B, TIP31C, (NPN), TIP32, TIP32A, TIP32B, TIP32C, (PNP)

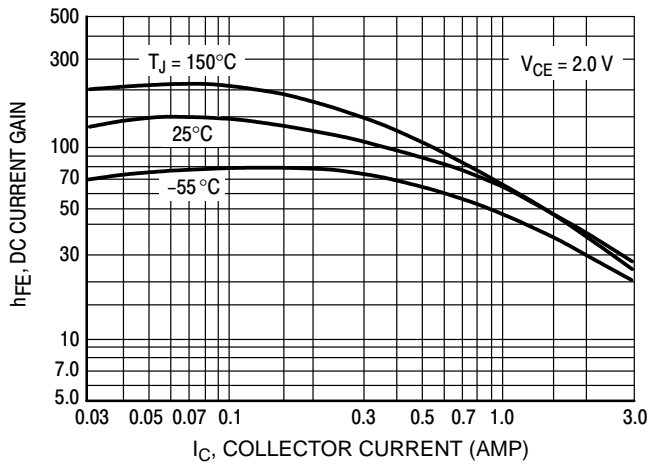

Figure 8. DC Current Gain

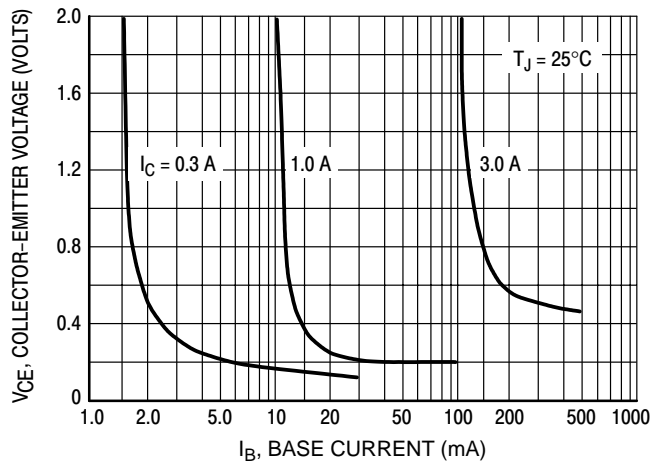

Figure 9. Collector Saturation Region

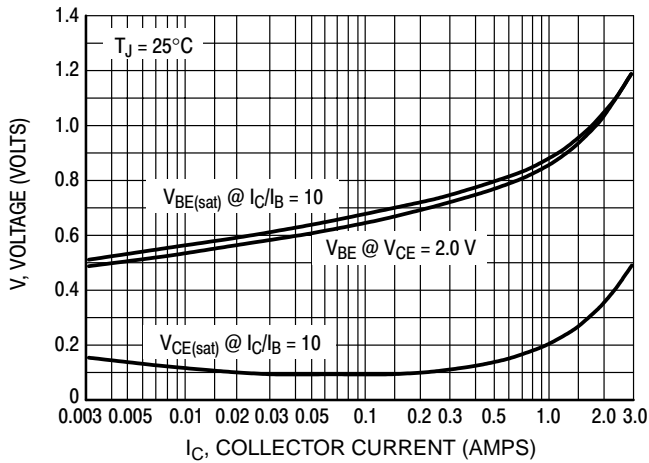

Figure 10. "On" Voltages

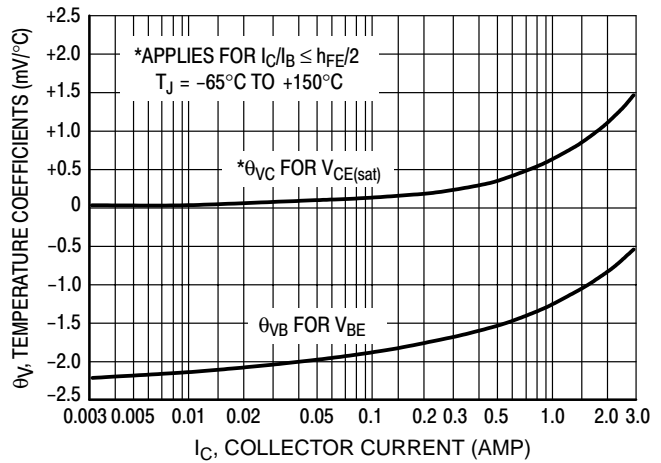

Figure 11. Temperature Coefficients

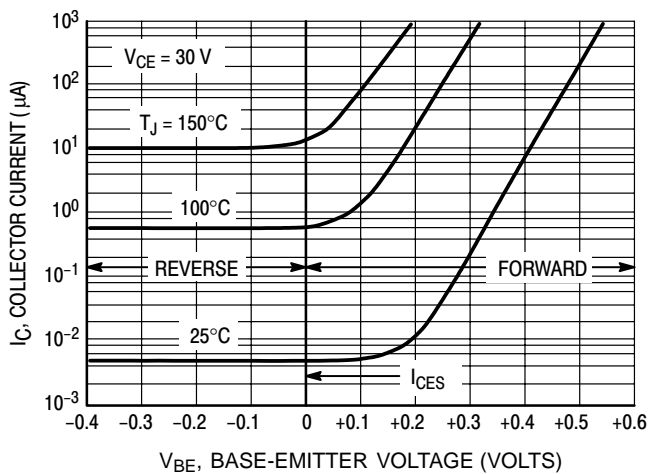

Figure 12. Collector Cut-Off Region

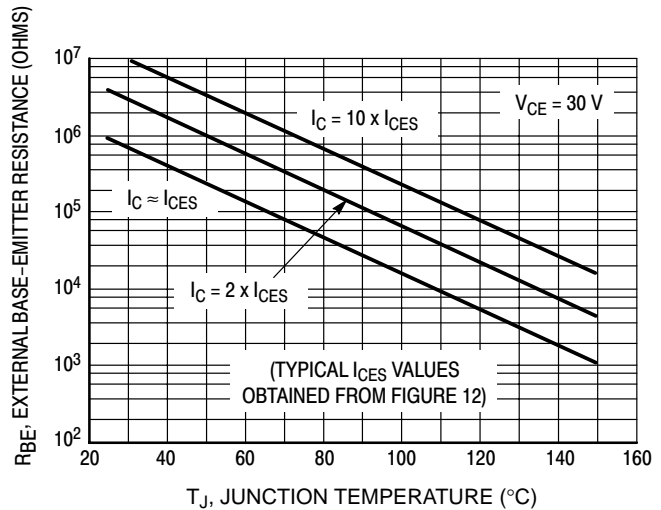

Figure 13. Effects of Base-Emitter Resistance

# TIP31, TIP31A, TIP31B, TIP31C, (NPN), TIP32, TIP32A, TIP32B, TIP32C, (PNP)

## ORDERING INFORMATION

Device	Package	Shipping
TIP31	TO-220AB	50 Units/Rail
TIP31A	TO-220AB	50 Units/Rail
TIP31B	TO-220AB	50 Units/Rail
TIP31C	TO-220AB	50 Units/Rail
TIP32	TO-220AB	50 Units/Rail
TIP32A	TO-220AB	50 Units/Rail
TIP32B	TO-220AB	50 Units/Rail
TIP32C	TO-220AB	50 Units/Rail

## PACKAGE DIMENSIONS

### TO-220AB CASE 221A-09 ISSUE AA

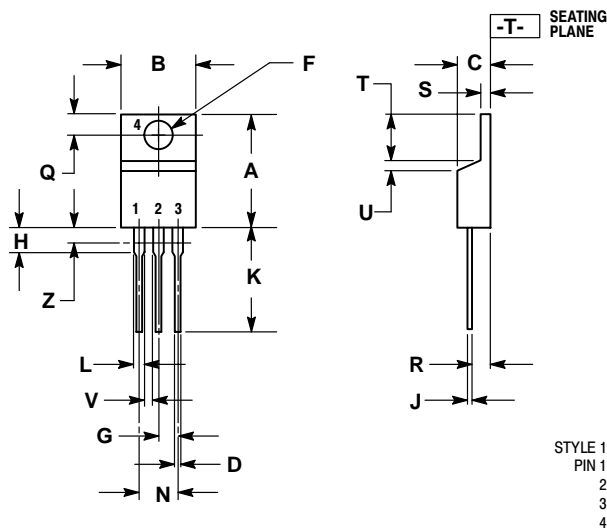

#### NOTES:

- DIMENSIONING AND TOLERANCING PER ANSI Y14.5M, 1982.
- CONTROLLING DIMENSION: INCH.
- DIMENSION Z DEFINES A ZONE WHERE ALL BODY AND LEAD IRREGULARITIES ARE ALLOWED.

DIM	INCHES		MILLIMETERS	
	MIN	MAX	MIN	MAX
A	0.570	0.620	14.48	15.75
B	0.380	0.405	9.66	10.28
C	0.160	0.190	4.07	4.82
D	0.025	0.035	0.64	0.88
F	0.142	0.147	3.61	3.73
G	0.095	0.105	2.42	2.66
H	0.110	0.155	2.80	3.93
J	0.018	0.025	0.46	0.64
K	0.500	0.562	12.70	14.27
L	0.045	0.060	1.15	1.52
N	0.190	0.210	4.83	5.33
Q	0.100	0.120	2.54	3.04
R	0.080	0.110	2.04	2.79
S	0.045	0.055	1.15	1.39
T	0.235	0.255	5.97	6.47
U	0.000	0.050	0.00	1.27
V	0.045	---	1.15	---
Z	---	0.080	---	2.04

#### STYLE 1:

- PIN 1. BASE
- COLLECTOR
- EMITTER
- COLLECTOR

ON Semiconductor and  are registered trademarks of Semiconductor Components Industries, LLC (SCILLC). SCILLC reserves the right to make changes without further notice to any products herein. SCILLC makes no warranty, representation or guarantee regarding the suitability of its products for any particular purpose, nor does SCILLC assume any liability arising out of the application or use of any product or circuit, and specifically disclaims any and all liability, including without limitation special, consequential or incidental damages. "Typical" parameters which may be provided in SCILLC data sheets and/or specifications can and do vary in different applications and actual performance may vary over time. All operating parameters, including "Typicals" must be validated for each customer application by customer's technical experts. SCILLC does not convey any license under its patent rights nor the rights of others. SCILLC products are not designed, intended, or authorized for use as components in systems intended for surgical implant into the body, or other applications intended to support or sustain life, or for any other application in which the failure of the SCILLC product could create a situation where personal injury or death may occur. Should Buyer purchase or use SCILLC products for any such unintended or unauthorized application, Buyer shall indemnify and hold SCILLC and its officers, employees, subsidiaries, affiliates, and distributors harmless against all claims, costs, damages, and expenses, and reasonable attorney fees arising out of, directly or indirectly, any claim of personal injury or death associated with such unintended or unauthorized use, even if such claim alleges that SCILLC was negligent regarding the design or manufacture of the part. SCILLC is an Equal Opportunity/Affirmative Action Employer.

## PUBLICATION ORDERING INFORMATION

#### Literature Fulfillment:

Literature Distribution Center for ON Semiconductor  
P.O. Box 5163, Denver, Colorado 80217 USA  
Phone: 303-675-2175 or 800-344-3860 Toll Free USA/Canada  
Fax: 303-675-2176 or 800-344-3867 Toll Free USA/Canada  
Email: ONlit@hibbertco.com

N. American Technical Support: 800-282-9855 Toll Free USA/Canada

JAPAN: ON Semiconductor, Japan Customer Focus Center  
2-9-1 Kamimeguro, Meguro-ku, Tokyo, Japan 153-0051  
Phone: 81-3-5773-3850  
Email: r14525@onsemi.com

ON Semiconductor Website: <http://onsemi.com>

For additional information, please contact your local Sales Representative.

## Looking for pricing, stock, or lifecycle information?

Click below to explore more details on WIN SOURCE:

- ⊖ [View TIP32CTU on WIN SOURCE](#)
- ⊖ [Fairchild/ON Semiconductor Information](#)

## Optimize Your Supply Chain with WIN SOURCE Solutions

- ✓ Global Sourcing Solution
- ✓ Obsolete Management
- ✓ Cost Control Management
- ✓ Shortage Management
- ✓ Alternative Solution
- ✓ Excess Inventory Management