



**THE DATASHEET OF  
TISP4070M3BJR-S**





TISP4070M3BJ THRU TISP4115M3BJ,  
TISP4125M3BJ THRU TISP4220M3BJ,  
TISP4240M3BJ THRU TISP4400M3BJ

**BIDIRECTIONAL THYRISTOR OVERVOLTAGE PROTECTORS**

**TISP4xxxM3BJ Overvoltage Protector Series**

ITU-T K.20/21/44/45 rating ..... 4 kV 10/700, 100 A 5/310

**Ion-Implanted Breakdown Region  
Precise and Stable Voltage  
Low Voltage Overshoot under Surge**

Device	V <sub>DRM</sub> V	V <sub>(BO)</sub> V
'4070	58	70
'4080	65	80
'4095	75	95
'4115	90	115
'4125	100	125
'4145	120	145
'4165	135	165
'4180	145	180
'4200	155	200
'4220	160	220
'4240	180	240
'4250	190	250
'4265	200	265
'4290	220	290
'4300	230	300
'4350	275	350
'4360	290	360
'4395	320	395
'4400	300	400

Low Differential Capacitance ..... 39 pF max.



..... **UL Recognized Component**

**SMBJ Package (Top View)**

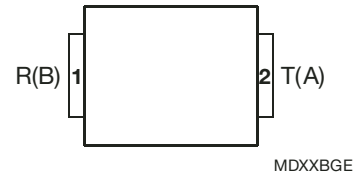

**Device Symbol**



Terminals T and R correspond to the alternative line designators of A and B

Wave Shape	Standard	I <sub>TSP</sub> A
2/10 μs	GR-1089-CORE	300
8/20 μs	IEC 61000-4-5	220
10/160 μs	FCC Part 68	120
10/700 μs	ITU-T K.20/21/45	100
10/560 μs	FCC Part 68	75
10/1000 μs	GR-1089-CORE	50

**Description**

These devices are designed to limit overvoltages on the telephone line. Overvoltages are normally caused by a.c. power system or lightning flash disturbances which are induced or conducted on to the telephone line. A single device provides 2-point protection and is typically used for the protection of 2-wire telecommunication equipment (e.g. between the Ring and Tip wires for telephones and modems). Combinations of devices can be used for multi-point protection (e.g. 3-point protection between Ring, Tip and Ground).

The protector consists of a symmetrical voltage-triggered bidirectional thyristor. Overvoltages are initially clipped by breakdown clamping until the voltage rises to the breakover level, which causes the device to crowbar into a low-voltage on state. This low-voltage on state causes the current resulting from the overvoltage to be safely diverted through the device. The high crowbar holding current helps prevent d.c. latchup as the diverted current subsides.

**How To Order**

Device	Package	Carrier	Order As
TISP 4xxxM3BJ	BJ (J-Bend DO-214AA/SMB)	Embossed Tape Reeled	TISP4xxxM3BJR-S

Insert xxx value corresponding to protection voltages of 070, 080, 095, 115, etc.



**WARNING Cancer and Reproductive Harm**  
[www.P65Warnings.ca.gov](http://www.P65Warnings.ca.gov)

NOVEMBER 1997 - REVISED MAY 2007  
\*RoHS Directive 2002/95/EC Jan. 27, 2003 including Annex.  
Specifications are subject to change without notice. Users should verify actual device performance in their specific applications. The products described herein and this document are subject to specific legal disclaimers as set forth on the last page of this document, and at [www.bourns.com/docs/legal/disclaimer.pdf](http://www.bourns.com/docs/legal/disclaimer.pdf).

# TISP4xxxM3BJ Overvoltage Protector Series

**BOURNS®**

## Description (continued)

The TISP4xxxM3BJ range consists of nineteen voltage variants to meet various maximum system voltage levels (58 V to 320 V). They are guaranteed to voltage limit and withstand the listed international lightning surges in both polarities. These medium (M) current protection devices are in a plastic package SMBJ (JEDEC DO-214AA with J-bend leads) and supplied in embossed tape reel pack. For alternative voltage and holding current values, consult the factory. For higher rated impulse currents in the SMB package, the 100 A 10/1000 TISP4xxxH3BJ series is available.

## Absolute Maximum Ratings, $T_A = 25^\circ\text{C}$ (Unless Otherwise Noted)

Rating	Symbol	Value	Unit
Repetitive peak off-state voltage, (see Note 1)	'4070	± 58	V
	'4080	± 65	
	'4095	± 75	
	'4115	± 90	
	'4125	±100	
	'4145	±120	
	'4165	±135	
	'4180	±145	
	'4200	±155	
	'4220	±160	
	'4240	±180	
	'4250	±190	
	'4265	±200	
	'4290	±220	
	'4300	±230	
	'4350	±275	
	'4360	±290	
	'4395	±320	
	'4400	±300	
Non-repetitive peak on-state pulse current (see Notes 2, 3 and 4) 2/10 $\mu\text{s}$ (GR-1089-CORE, 2/10 $\mu\text{s}$ voltage wave shape) 8/20 $\mu\text{s}$ (IEC 61000-4-5, combination wave generator, 1.2/50 voltage, 8/20 current) 10/160 $\mu\text{s}$ (FCC Part 68, 10/160 $\mu\text{s}$ voltage wave shape) 5/200 $\mu\text{s}$ (VDE 0433, 10/700 $\mu\text{s}$ voltage wave shape) 0.2/310 $\mu\text{s}$ (I3124, 0.5/700 $\mu\text{s}$ voltage wave shape) 5/310 $\mu\text{s}$ (ITU-T K.20/21/45, K.44 10/700 $\mu\text{s}$ voltage wave shape) 5/310 $\mu\text{s}$ (FTZ R12, 10/700 $\mu\text{s}$ voltage wave shape) 10/560 $\mu\text{s}$ (FCC Part 68, 10/560 $\mu\text{s}$ voltage wave shape) 10/1000 $\mu\text{s}$ (GR-1089-CORE, 10/1000 $\mu\text{s}$ voltage wave shape)	$I_{TSP}$	300 220 120 110 100 100 100 75 50	A
Non-repetitive peak on-state current (see Notes 2, 3 and 5) 20 ms (50 Hz) full sine wave 16.7 ms (60 Hz) full sine wave 1000 s 50 Hz/60 Hz a.c.	$I_{TSM}$	30 32 2.1	A
Initial rate of rise of on-state current, Exponential current ramp, Maximum ramp value < 100 A	$di_T/dt$	300	A/ $\mu\text{s}$
Junction temperature	$T_J$	-40 to +150	$^\circ\text{C}$
Storage temperature range	$T_{stg}$	-65 to +150	$^\circ\text{C}$

- NOTES: 1. See Applications Information and Figure 11 for voltage values at lower temperatures.  
2. Initially, the TISP4xxxM3BJ must be in thermal equilibrium with  $T_J = 25^\circ\text{C}$ .  
3. The surge may be repeated after the TISP4xxxM3BJ returns to its initial conditions.  
4. See Applications Information and Figure 12 for current ratings at other temperatures.  
5. EIA/JESD51-2 environment and EIA/JESD51-3 PCB with standard footprint dimensions connected with 5 A rated printed wiring track widths. See Figure 9 for the current ratings at other durations. Derate current values at  $-0.61\%/\text{C}$  for ambient temperatures above  $25^\circ\text{C}$ .

NOVEMBER 1997 - REVISED MAY 2007

Specifications are subject to change without notice.

Users should verify actual device performance in their specific applications.

The products described herein and this document are subject to specific legal disclaimers as set forth on the last page of this document, and at [www.bourns.com/docs/legal/disclaimer.pdf](http://www.bourns.com/docs/legal/disclaimer.pdf).

# TISP4xxxM3BJ Overtolerance Protector Series

**BOURNS®**

## Electrical Characteristics, $T_A = 25\text{ }^\circ\text{C}$ (Unless Otherwise Noted)

Parameter	Test Conditions	Min	Typ	Max	Unit
$I_{\text{DRM}}$ Repetitive peak off-state current	$V_D = V_{\text{DRM}}$ $T_A = 25\text{ }^\circ\text{C}$ $T_A = 85\text{ }^\circ\text{C}$			$\pm 5$ $\pm 10$	$\mu\text{A}$
$V_{(\text{BO})}$ Breakover voltage	$dv/dt = \pm 250\text{ V/ms}$ , $R_{\text{SOURCE}} = 300\ \Omega$			$\pm 70$ $\pm 80$ $\pm 95$ $\pm 115$ $\pm 125$ $\pm 145$ $\pm 165$ $\pm 180$ $\pm 200$ $\pm 220$ $\pm 240$ $\pm 250$ $\pm 265$ $\pm 290$ $\pm 300$ $\pm 350$ $\pm 360$ $\pm 395$ $\pm 400$	V
$V_{(\text{BO})}$ Impulse breakover voltage	$dv/dt \leq \pm 1000\text{ V}/\mu\text{s}$ , Linear voltage ramp, Maximum ramp value = $\pm 500\text{ V}$ $di/dt = \pm 20\text{ A}/\mu\text{s}$ , Linear current ramp, Maximum ramp value = $\pm 10\text{ A}$			$\pm 78$ $\pm 88$ $\pm 102$ $\pm 122$ $\pm 132$ $\pm 151$ $\pm 171$ $\pm 186$ $\pm 207$ $\pm 227$ $\pm 247$ $\pm 257$ $\pm 272$ $\pm 298$ $\pm 308$ $\pm 359$ $\pm 370$ $\pm 405$ $\pm 410$	V
$I_{(\text{BO})}$ Breakover current	$dv/dt = \pm 250\text{ V/ms}$ , $R_{\text{SOURCE}} = 300\ \Omega$	$\pm 0.15$		$\pm 0.6$	A
$V_T$ On-state voltage	$I_T = \pm 5\text{ A}$ , $t_W = 100\ \mu\text{s}$			$\pm 3$	V
$I_H$ Holding current	$I_T = \pm 5\text{ A}$ , $di/dt = \pm 30\text{ mA/ms}$	$\pm 0.15$		$\pm 0.35$	A
$dv/dt$ Critical rate of rise of off-state voltage	Linear voltage ramp, Maximum ramp value $< 0.85V_{\text{DRM}}$	$\pm 5$			$\text{kV}/\mu\text{s}$
$I_D$ Off-state current	$V_D = \pm 50\text{ V}$ $T_A = 85\text{ }^\circ\text{C}$			$\pm 10$	$\mu\text{A}$

NOVEMBER 1997 - REVISED MAY 2007

Specifications are subject to change without notice.

Users should verify actual device performance in their specific applications.

The products described herein and this document are subject to specific legal disclaimers as set forth on the last page of this document, and at [www.bourns.com/docs/legal/disclaimer.pdf](http://www.bourns.com/docs/legal/disclaimer.pdf).

# TISP4xxxM3BJ Overvoltage Protector Series

**BOURNS®**

## Electrical Characteristics, $T_A = 25\text{ }^\circ\text{C}$ (Unless Otherwise Noted)

Parameter	Test Conditions	Min	Typ	Max	Unit
$C_{off}$ Off-state capacitance	f = 1 MHz, $V_d = 1\text{ V rms}$ , $V_D = 0$ ,	4070 thru '4115	83	100	pF
		'4125 thru '4220	62	74	
		'4240 thru '4400	50	60	
	f = 1 MHz, $V_d = 1\text{ V rms}$ , $V_D = -1\text{ V}$	'4070 thru '4115	78	94	
		'4125 thru '4220	56	67	
		'4240 thru '4400	45	54	
	f = 1 MHz, $V_d = 1\text{ V rms}$ , $V_D = -2\text{ V}$	'4070 thru '4115	72	87	
		'4125 thru '4220	52	62	
		'4240 thru '4400	42	50	
	f = 1 MHz, $V_d = 1\text{ V rms}$ , $V_D = -50\text{ V}$	'4070 thru '4115	36	44	
		'4125 thru '4220	26	31	
		'4240 thru '4400	19	22	
f = 1 MHz, $V_d = 1\text{ V rms}$ , $V_D = -100\text{ V}$ (see Note 6)	'4125 thru '4220	21	25		
	'4240 thru '4400	15	18		

NOTE 6: To avoid possible voltage clipping, the '4125 is tested with  $V_D = -98\text{ V}$ .

## Thermal Characteristics

Parameter	Test Conditions	Min	Typ	Max	Unit
$R_{\theta JA}$ Junction to free air thermal resistance	EIA/JESD51-3 PCB, $I_T = I_{TSM(1000)}$ , $T_A = 25\text{ }^\circ\text{C}$ , (see Note 7)			115	$^\circ\text{C/W}$
	265 mm x 210 mm populated line card, 4-layer PCB, $I_T = I_{TSM(1000)}$ , $T_A = 25\text{ }^\circ\text{C}$		52		

NOTE 7: EIA/JESD51-2 environment and PCB has standard footprint dimensions connected with 5 A rated printed wiring track widths.

## Parameter Measurement Information

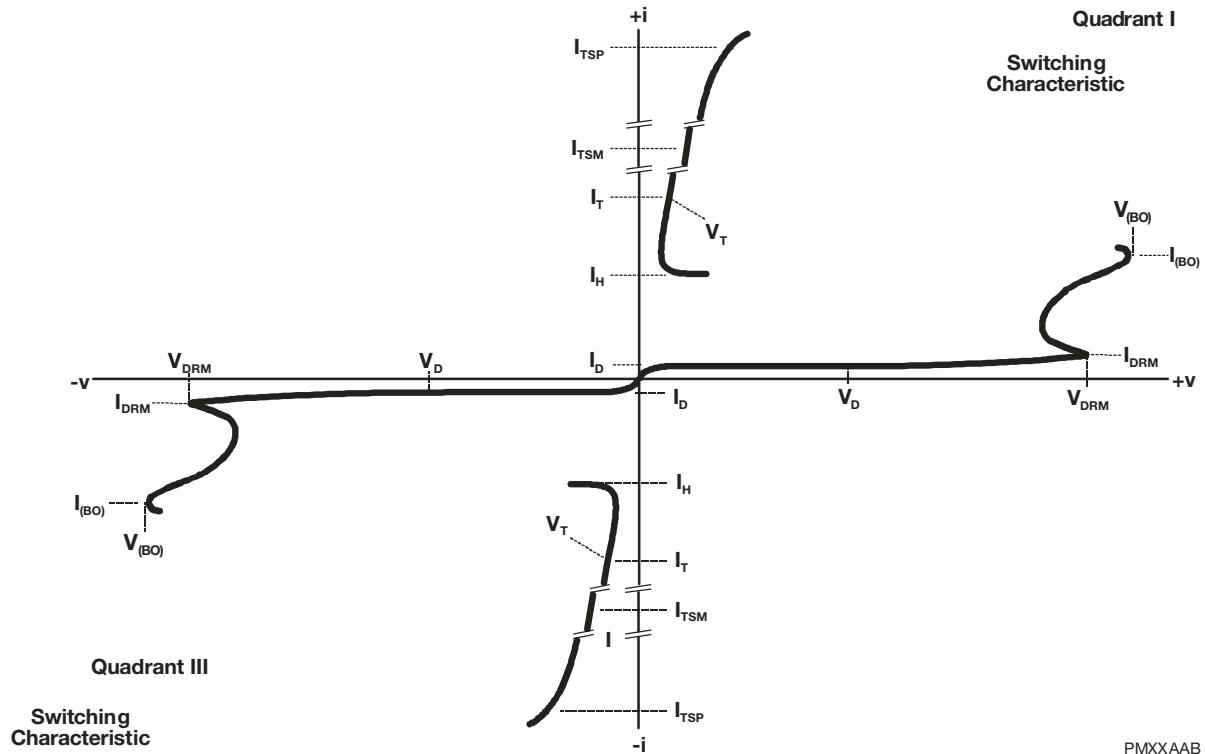

Figure 1. Voltage-Current Characteristic for T and R Terminals  
All Measurements are Referenced to the R Terminal

PMXXAAB

## Typical Characteristics

**OFF-STATE CURRENT  
vs  
JUNCTION TEMPERATURE**

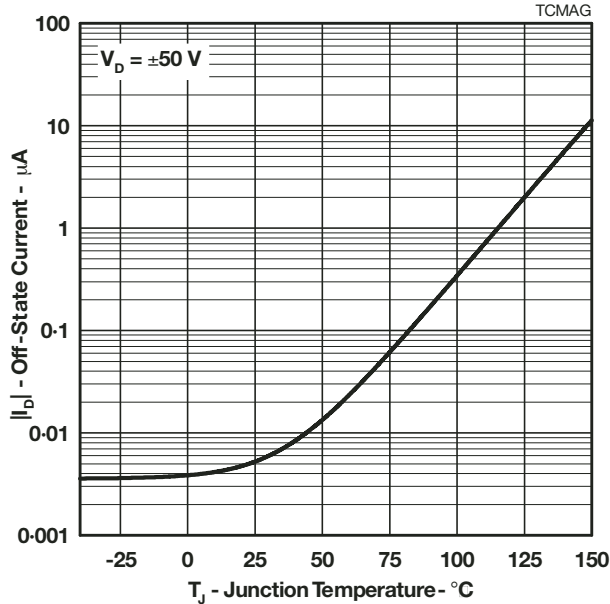

Figure 2.

**NORMALIZED BREAKOVER VOLTAGE  
vs  
JUNCTION TEMPERATURE**

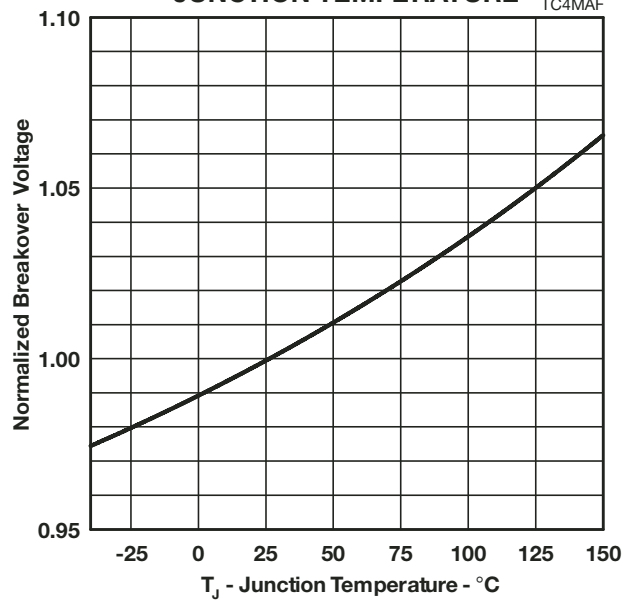

Figure 3.

**ON-STATE CURRENT  
vs  
ON-STATE VOLTAGE**

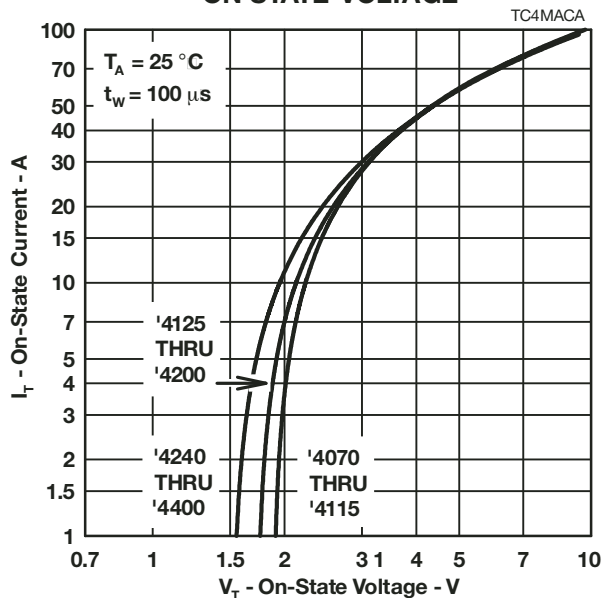

Figure 4.

**NORMALIZED HOLDING CURRENT  
vs  
JUNCTION TEMPERATURE**

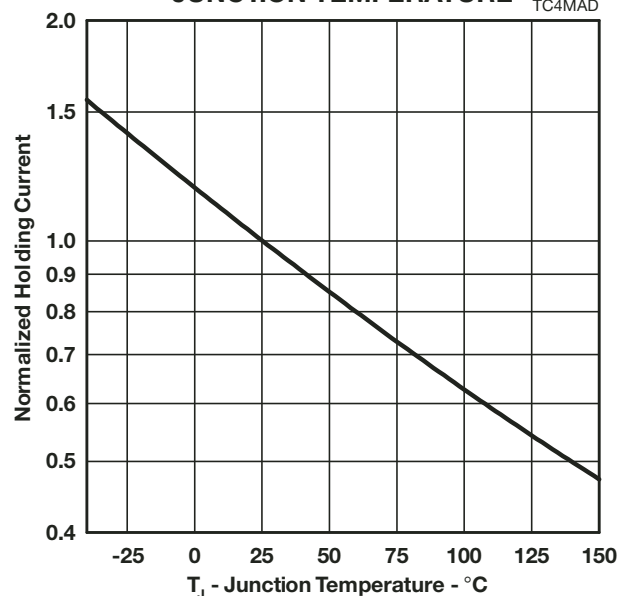
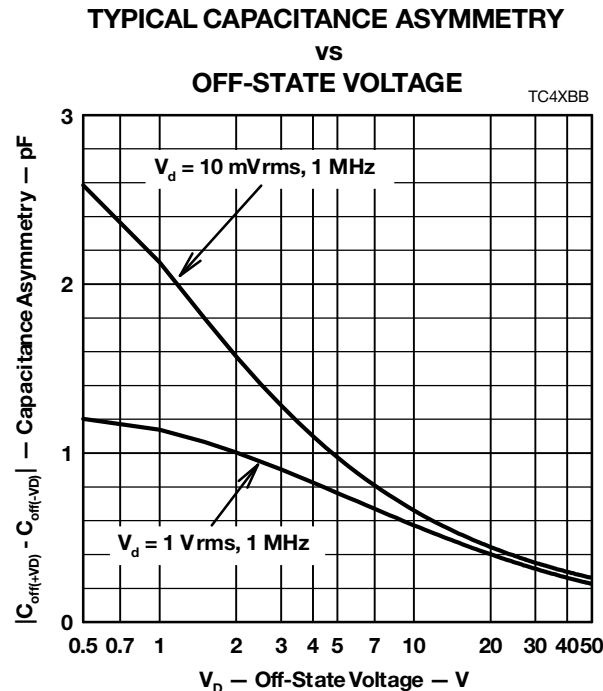
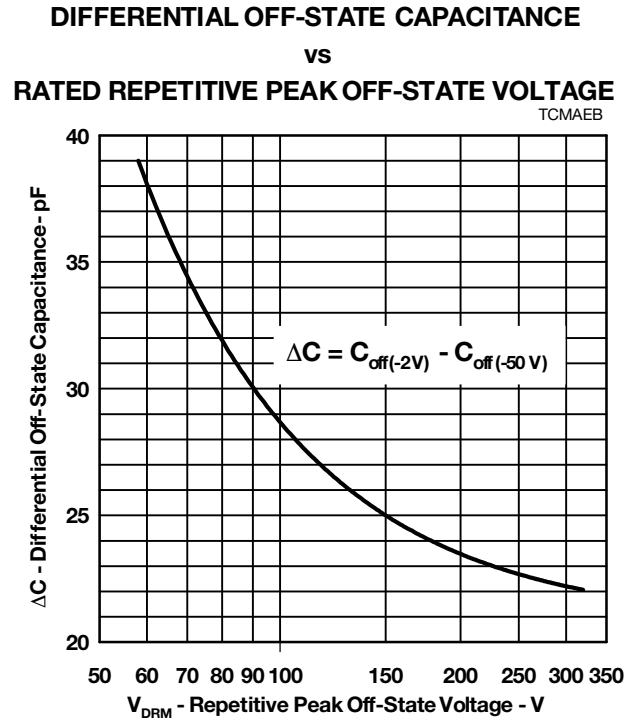
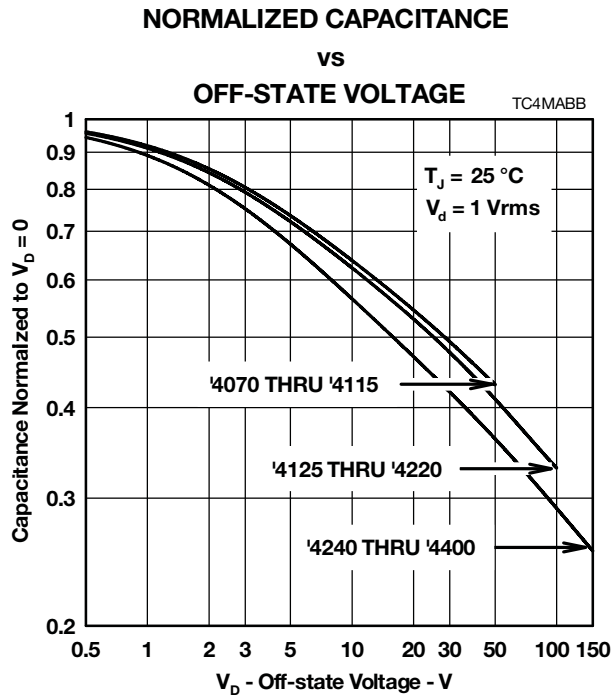

Figure 5.

## Typical Characteristics



## Rating and Thermal Information

### NON-REPETITIVE PEAK ON-STATE CURRENT

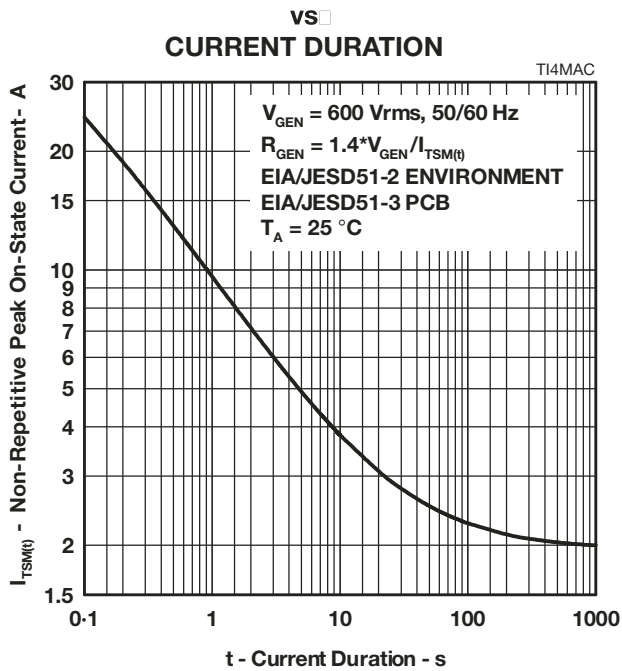

### THERMAL IMPEDANCE

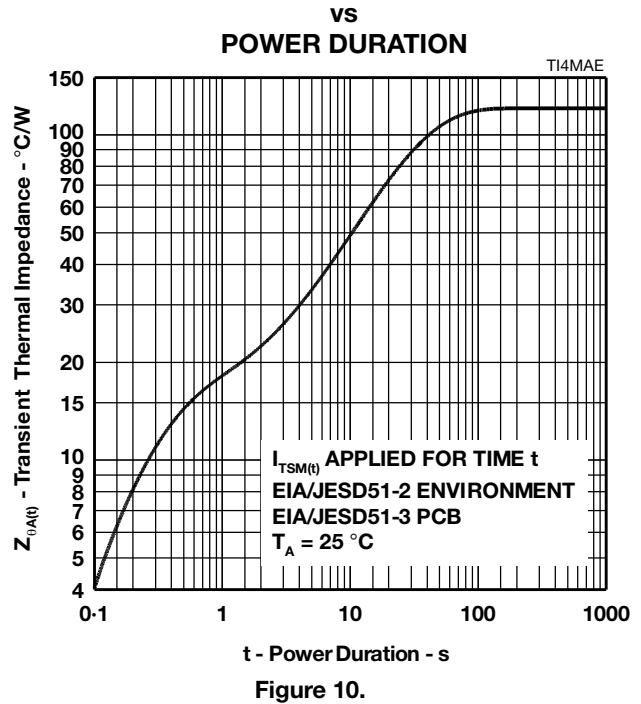

### V\_DRM DERATING FACTOR

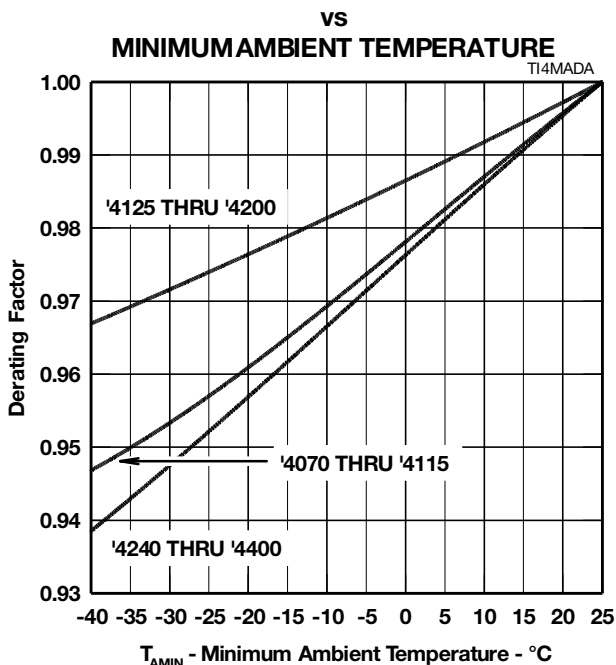

### IMPULSE RATING

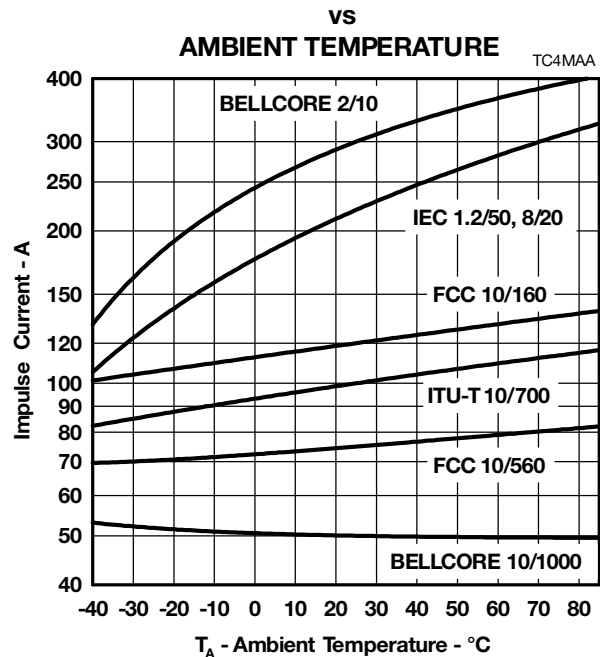

NOVEMBER 1997 - REVISED MAY 2007

Specifications are subject to change without notice.

Users should verify actual device performance in their specific applications.

The products described herein and this document are subject to specific legal disclaimers as set forth on the last page of this document, and at [www.bourns.com/docs/legal/disclaimer.pdf](http://www.bourns.com/docs/legal/disclaimer.pdf).

## APPLICATIONS INFORMATION

### Deployment

These devices are two terminal overvoltage protectors. They may be used either singly to limit the voltage between two conductors (Figure 13) or in multiples to limit the voltage at several points in a circuit (Figure 14).

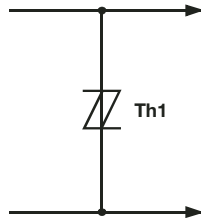

Figure 13. Two Point Protection

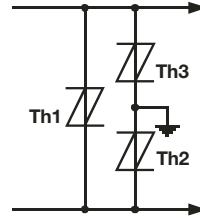

Figure 14. Multi-Point Protection

In Figure 13, protector Th1 limits the maximum voltage between the two conductors to  $\pm V_{(BO)}$ . This configuration is normally used to protect circuits without a ground reference, such as modems. In Figure 14, protectors Th2 and Th3 limit the maximum voltage between each conductor and ground to the  $\pm V_{(BO)}$  of the individual protector. Protector Th1 limits the maximum voltage between the two conductors to its  $\pm V_{(BO)}$  value. If the equipment being protected has all its vulnerable components connected between the conductors and ground, then protector Th1 is not required.

### Impulse Testing

To verify the withstand capability and safety of the equipment, standards require that the equipment is tested with various impulse wave forms. The table below shows some common values.

Standard	Peak Voltage Setting V	Voltage Wave Shape $\mu s$	Peak Current Value A	Current Wave Shape $\mu s$	TISP4XXXM3 25 °C Rating A	Series Resistance $\Omega$
GR-1089-CORE	2500	2/10	500	2/10	300	11
	1000	10/1000	100	10/1000	50	
FCC Part 68 (March 1998)	1500	10/160	200	10/160	120	2x5.6
	800	10/560	100	10/560	75	3
	1500	9/720 †	37.5	5/320 †	100	0
I3124	1000	9/720 †	25	5/320 †	100	0
	1500	0.5/700	37.5	0.2/310	100	0
ITU-T K.20/K.21	1500	10/700	37.5	5/310	100	0
	4000		100			

† FCC Part 68 terminology for the waveforms produced by the ITU-T recommendation K.21 10/700 impulse generator

If the impulse generator current exceeds the protector's current rating, then a series resistance can be used to reduce the current to the protector's rated value to prevent possible failure. The required value of series resistance for a given waveform is given by the following calculations. First, the minimum total circuit impedance is found by dividing the impulse generator's peak voltage by the protector's rated current. The impulse generator's fictive impedance (generator's peak voltage divided by peak short circuit current) is then subtracted from the minimum total circuit impedance to give the required value of series resistance.

For the FCC Part 68 10/560 waveform, the following values result. The minimum total circuit impedance is  $800/75 = 10.7 \Omega$  and the generator's fictive impedance is  $800/100 = 8 \Omega$ . This gives a minimum series resistance value of  $10.7 - 8 = 2.7 \Omega$ . After allowing for tolerance, a  $3 \Omega \pm 10\%$  resistor would be suitable. The 10/160 waveform needs a standard resistor value of  $5.6 \Omega$  per conductor. These would be R1a and R1b in Figure 16 and Figure 17. FCC Part 68 allows the equipment to be non-operational after the 10/160 (conductor to ground) and 10/560 (inter-conductor) impulses. The series resistor value may be reduced to zero to pass FCC Part 68 in a non-operational mode, e.g. Figure 15. For this type of design, the series fuse must open before the TISP4xxxM3 fails. For Figure 15, the maximum fuse  $i^2t$  is  $2.3 A^2s$ . In some cases, the equipment will require verification over a temperature range. By using the rated waveform values from Figure 12, the appropriate series resistor value can be calculated for ambient temperatures in the range of  $-40 \text{ }^\circ\text{C}$  to  $85 \text{ }^\circ\text{C}$ .

NOVEMBER 1997 - REVISED MAY 2007

Specifications are subject to change without notice.

Users should verify actual device performance in their specific applications.

The products described herein and this document are subject to specific legal disclaimers as set forth on the last page of this document, and at [www.bourns.com/docs/legal/disclaimer.pdf](http://www.bourns.com/docs/legal/disclaimer.pdf).

### AC Power Testing

The protector can withstand currents applied for times not exceeding those shown in Figure 9. Currents that exceed these times must be terminated or reduced to avoid protector failure. Fuses, PTC (Positive Temperature Coefficient) thermistors and fusible resistors are overcurrent protection devices which can be used to reduce the current flow. Protective fuses may range from a few hundred milliamperes to one ampere. In some cases, it may be necessary to add some extra series resistance to prevent the fuse opening during impulse testing. The current versus time characteristic of the overcurrent protector must be below the line shown in Figure 9. In some cases, there may be a further time limit imposed by the test standard (e.g. UL 1459 wiring simulator failure).

### Capacitance

The protector characteristic off-state capacitance values are given for d.c. bias voltage,  $V_D$ , values of 0, -1 V, -2 V and -50 V. Where possible values are also given for -100 V. Values for other voltages may be calculated by multiplying the  $V_D = 0$  capacitance value by the factor given in Figure 6. Up to 10 MHz, the capacitance is essentially independent of frequency. Above 10 MHz, the effective capacitance is strongly dependent on connection inductance. In many applications, such as Figure 16 and Figure 18, the typical conductor bias voltages will be about -2 V and -50 V. Figure 7 shows the differential (line unbalance) capacitance caused by biasing one protector at -2 V and the other at -50 V.

Figure 8 shows the typical capacitance asymmetry; the difference between the capacitance measured with a positive value of  $V_D$  and the capacitance value when the polarity of  $V_D$  is reversed. Capacitance asymmetry is an important parameter in ADSL systems where the protector often has no d.c. bias and the signal level is in the region of  $\pm 10$  V.

### Normal System Voltage Levels

The protector should not clip or limit the voltages that occur in normal system operation. For unusual conditions, such as ringing without the line connected, some degree of clipping is permissible. Under this condition, about 10 V of clipping is normally possible without activating the ring trip circuit.

Figure 11 allows the calculation of the protector  $V_{DRM}$  value at temperatures below 25 °C. The calculated value should not be less than the maximum normal system voltages. The TISP4265M3BJ, with a  $V_{DRM}$  of 200 V, can be used for the protection of ring generators producing 100 V rms of ring on a battery voltage of -58 V (Th2 and Th3 in Figure 18). The peak ring voltage will be  $58 + 1.414 \times 100 = 199.4$  V. However, this is the open circuit voltage and the connection of the line and its equipment will reduce the peak voltage. In the extreme case of an unconnected line, clipping the peak voltage to 190 V should not activate the ring trip. This level of clipping would occur at the temperature when the  $V_{DRM}$  has reduced to  $190/200 = 0.95$  of its 25 °C value. Figure 11 shows that this condition will occur at an ambient temperature of -28 °C. In this example, the TISP4265M3BJ will allow normal equipment operation provided that the minimum expected ambient temperature does not fall below -28 °C.

### JESD51 Thermal Measurement Method

To standardize thermal measurements, the EIA (Electronic Industries Alliance) has created the JESD51 standard. Part 2 of the standard (JESD51-2, 1995) describes the test environment. This is a  $0.0283 \text{ m}^3$  ( $1 \text{ ft}^3$ ) cube which contains the test PCB (Printed Circuit Board) horizontally mounted at the center. Part 3 of the standard (JESD51-3, 1996) defines two test PCBs for surface mount components; one for packages smaller than 27 mm on a side and the other for packages up to 48 mm. The SMBJ measurements used the smaller 76.2 mm x 114.3 mm (3.0 " x 4.5 ") PCB. The JESD51-3 PCBs are designed to have low effective thermal conductivity (high thermal resistance) and represent a worst case condition. The PCBs used in the majority of applications will achieve lower values of thermal resistance, and can dissipate higher power levels than indicated by the JESD51 values.

# TISP4xxxM3BJ Overvoltage Protector Series

**BOURNS®**

## Typical Circuits

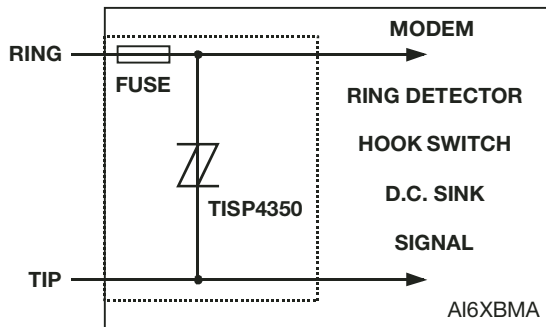

Figure 15. Modem Inter-Wire Protection

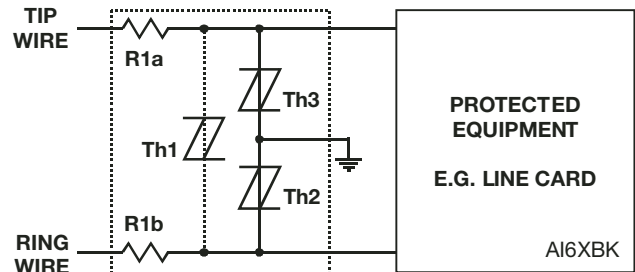

Figure 16. PROTECTION MODULE

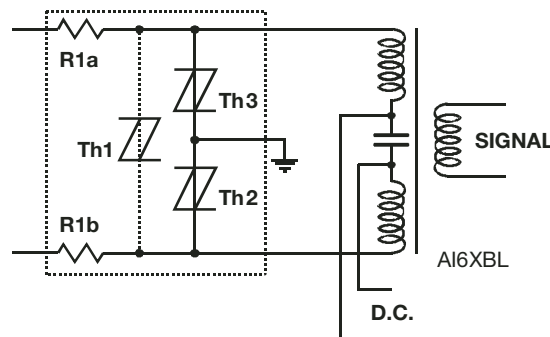

Figure 17. ISDN Protection

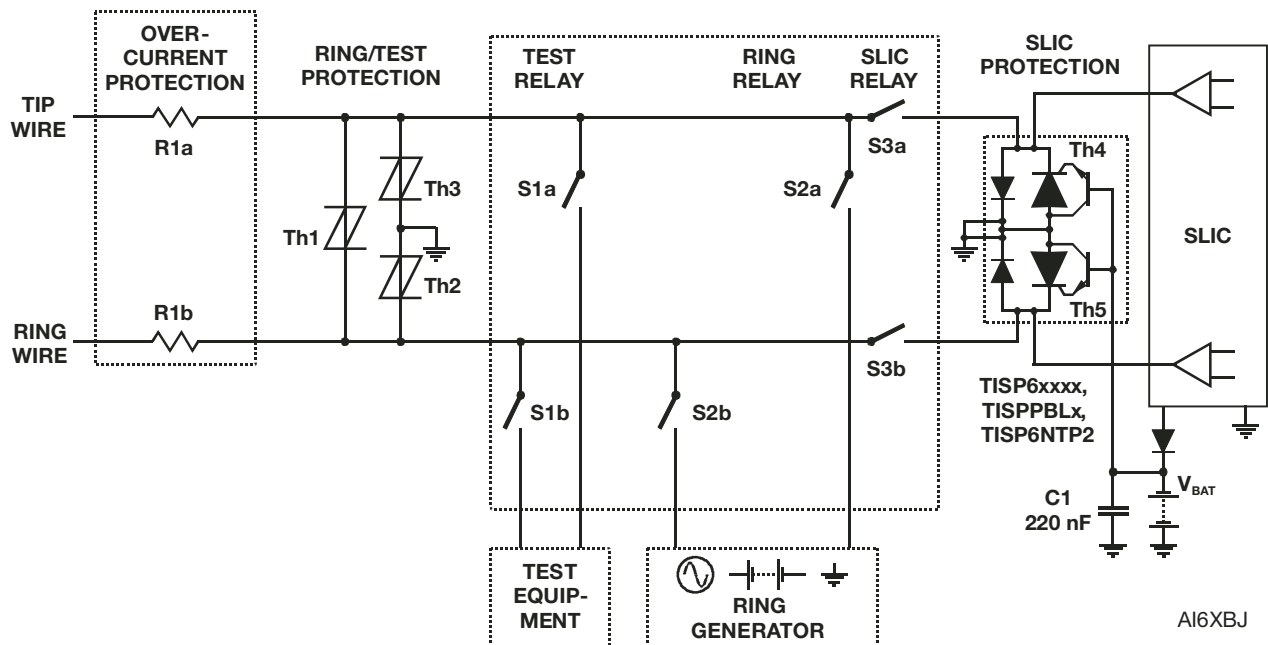

Figure 18. Line Card Ring/Test Protection

NOVEMBER 1997 - REVISED MAY 2007

Specifications are subject to change without notice.

Users should verify actual device performance in their specific applications.

The products described herein and this document are subject to specific legal disclaimers as set forth on the last page of this document, and at [www.bourns.com/docs/legal/disclaimer.pdf](http://www.bourns.com/docs/legal/disclaimer.pdf).

# TISP4xxxM3BJ Overvoltage Protector Series

**BOURNS®**

## Device Symbolization Code

Devices will be coded as below. As the device parameters are symmetrical, terminal 1 is not identified.

Device	Symbolization Code
TISP4070M3BJ	4070M3
TISP4080M3BJ	4080M3
TISP4095M3BJ	4095M3
TISP4115M3BJ	4115M3
TISP4125M3BJ	4125M3
TISP4145M3BJ	4145M3
TISP4165M3BJ	4165M3
TISP4180M3BJ	4180M3
TISP4200M3BJ	4200M3
TISP4220M3BJ	4220M3
TISP4240M3BJ	4240M3
TISP4250M3BJ	4250M3
TISP4265M3BJ	4265M3
TISP4290M3BJ	4290M3
TISP4300M3BJ	4300M3
TISP4350M3BJ	4350M3
TISP4360M3BJ	4360M3
TISP4395M3BJ	4395M3
TISP4400M3BJ	4400M3

"TISP" is a trademark of Bourns, Ltd., a Bourns Company, and is Registered in U.S. Patent and Trademark Office.  
"Bourns" is a registered trademark of Bourns, Inc. in the U.S. and other countries.

NOVEMBER 1997 - REVISED MAY 2007

Specifications are subject to change without notice.

Users should verify actual device performance in their specific applications.

The products described herein and this document are subject to specific legal disclaimers as set forth on the last page of this document, and at [www.bourns.com/docs/legal/disclaimer.pdf](http://www.bourns.com/docs/legal/disclaimer.pdf).

This legal disclaimer applies to purchasers and users of Bourns® products manufactured by or on behalf of Bourns, Inc. and its affiliates (collectively, “Bourns”).

Unless otherwise expressly indicated in writing, Bourns® products and data sheets relating thereto are subject to change without notice. Users should check for and obtain the latest relevant information and verify that such information is current and complete before placing orders for Bourns® products.

The characteristics and parameters of a Bourns® product set forth in its data sheet are based on laboratory conditions, and statements regarding the suitability of products for certain types of applications are based on Bourns’ knowledge of typical requirements in generic applications. The characteristics and parameters of a Bourns® product in a user application may vary from the data sheet characteristics and parameters due to (i) the combination of the Bourns® product with other components in the user’s application, or (ii) the environment of the user application itself. The characteristics and parameters of a Bourns® product also can and do vary in different applications and actual performance may vary over time. Users should always verify the actual performance of the Bourns® product in their specific devices and applications, and make their own independent judgments regarding the amount of additional test margin to design into their device or application to compensate for differences between laboratory and real world conditions.

Unless Bourns has explicitly designated an individual Bourns® product as meeting the requirements of a particular industry standard (e.g., ISO/TS 16949) or a particular qualification (e.g., UL listed or recognized), Bourns is not responsible for any failure of an individual Bourns® product to meet the requirements of such industry standard or particular qualification. Users of Bourns® products are responsible for ensuring compliance with safety-related requirements and standards applicable to their devices or applications.

Bourns® products are not recommended, authorized or intended for use in nuclear, lifesaving, life-critical or life-sustaining applications, nor in any other applications where failure or malfunction may result in personal injury, death, or severe property or environmental damage. Unless expressly and specifically approved in writing by two authorized Bourns representatives on a case-by-case basis, use of any Bourns® products in such unauthorized applications might not be safe and thus is at the user’s sole risk. Life-critical applications include devices identified by the U.S. Food and Drug Administration as Class III devices and generally equivalent classifications outside of the United States.

Bourns expressly identifies those Bourns® standard products that are suitable for use in automotive applications on such products’ data sheets in the section entitled “Applications.” Unless expressly and specifically approved in writing by two authorized Bourns representatives on a case-by-case basis, use of any other Bourns® standard products in an automotive application might not be safe and thus is not recommended, authorized or intended and is at the user’s sole risk. If Bourns expressly identifies a sub-category of automotive application in the data sheet for its standard products (such as infotainment or lighting), such identification means that Bourns has reviewed its standard product and has determined that if such Bourns® standard product is considered for potential use in automotive applications, it should only be used in such sub-category of automotive applications. Any reference to Bourns® standard product in the data sheet as compliant with the AEC-Q standard or “automotive grade” does not by itself mean that Bourns has approved such product for use in an automotive application.

Bourns® standard products are not tested to comply with United States Federal Aviation Administration standards generally or any other generally equivalent governmental organization standard applicable to products designed or manufactured for use in aircraft or space applications. Bourns expressly identifies Bourns® standard products that are suitable for use in aircraft or space applications on such products’ data sheets in the section entitled “Applications.” Unless expressly and specifically approved in writing by two authorized Bourns representatives on a case-by-case basis, use of any other Bourns® standard product in an aircraft or space application might not be safe and thus is not recommended, authorized or intended and is at the user’s sole risk.

The use and level of testing applicable to Bourns® custom products shall be negotiated on a case-by-case basis by Bourns and the user for which such Bourns® custom products are specially designed. Absent a written agreement between Bourns and the user regarding the use and level of such testing, the above provisions applicable to Bourns® standard products shall also apply to such Bourns® custom products.

Users shall not sell, transfer, export or re-export any Bourns® products or technology for use in activities which involve the design, development, production, use or stockpiling of nuclear, chemical or biological weapons or missiles, nor shall they use Bourns® products or technology in any facility which engages in activities relating to such devices. The foregoing restrictions apply to all uses and applications that violate national or international prohibitions, including embargos or international regulations. Further, Bourns® products and Bourns technology and technical data may not under any circumstance be exported or re-exported to countries subject to international sanctions or embargoes. Bourns® products may not, without prior authorization from Bourns and/or the U.S. Government, be resold, transferred, or re-exported to any party not eligible to receive U.S. commodities, software, and technical data.

To the maximum extent permitted by applicable law, Bourns disclaims (i) any and all liability for special, punitive, consequential, incidental or indirect damages or lost revenues or lost profits, and (ii) any and all implied warranties, including implied warranties of fitness for particular purpose, non-infringement and merchantability.

*For your convenience, copies of this Legal Disclaimer Notice with German, Spanish, Japanese, Traditional Chinese and Simplified Chinese bilingual versions are available at:*

*Web Page:* <http://www.bourns.com/legal/disclaimers-terms-and-policies>

*PDF:* <http://www.bourns.com/docs/Legal/disclaimer.pdf>

## Looking for pricing, stock, or lifecycle information?

Click below to explore more details on WIN SOURCE:

 [View TISP4070M3BJR-S on WIN SOURCE](#)

 [Bourns Inc. Information](#)

## Optimize Your Supply Chain with WIN SOURCE Solutions

-  Global Sourcing Solution
-  Obsolete Management
-  Cost Control Management
-  Shortage Management
-  Alternative Solution
-  Excess Inventory Management