



**THE DATASHEET OF
TL750M05CKVURG3**



LOW-DROPOUT VOLTAGE REGULATORS

 Check for Samples: [TL750M SERIES](#)

FEATURES

- Low Dropout Voltage, Less Than 0.6 V at 750 mA
- Low Quiescent Current
- 60-V Load-Dump Protection
- Overvoltage Protection
- Internal Thermal-Overload Protection
- Internal Overcurrent-Limiting Circuitry

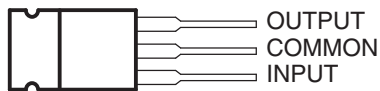
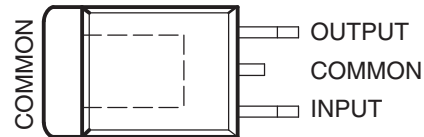
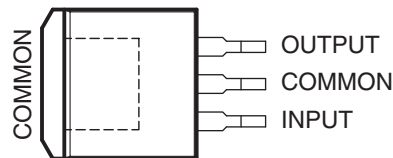
KCS PACKAGE⁽¹⁾
(TOP VIEW)

KVU PACKAGE⁽¹⁾
(TOP VIEW)

KTT PACKAGE⁽¹⁾
(TOP VIEW)

(1) The common terminal is in electrical contact with the mounting base.

DESCRIPTION/ORDERING INFORMATION

The TL750M series devices are low-dropout positive voltage regulators specifically designed for battery-powered systems. The TL750M devices incorporate onboard overvoltage and current-limiting protection circuitry to protect the devices and the regulated system. The devices are fully protected against 60-V load-dump and reverse-battery conditions. Extremely low quiescent current, even during full-load conditions, makes the TL750M series ideal for standby power systems.

The TL750M offers 5-V, 8-V, 10-V, and 12-V options. The devices are characterized for operation over the virtual junction temperature range 0°C to 125°C.



Please be aware that an important notice concerning availability, standard warranty, and use in critical applications of Texas Instruments semiconductor products and disclaimers thereto appears at the end of this data sheet.



These devices have limited built-in ESD protection. The leads should be shorted together or the device placed in conductive foam during storage or handling to prevent electrostatic damage to the MOS gates.

ORDERING INFORMATION⁽¹⁾

T _J	V _O TYP	PACKAGE ⁽²⁾		ORDERABLE PART NUMBER	TOP-SIDE MARKING
0°C to 125°C	5 V	PowerFLEX™ – KVV	Reel of 3000	TL750M05CKVUR	750M05C
		TO-220 – KCS	Tube of 50	TL750M05CKCS	TL750M05C
		TO-263 – KTT	Reel of 500	TL750M05CKTTR	TL750M05C
	8 V	TO-220 – KCS	Tube of 50	TL750M08CKCS	TL750M08C
		PowerFLEX – KVV	Reel of 3000	TL750M08CKVUR	750M08C
	10 V	TO-220 – KCS	Tube of 50	TL750M10CKCS	TL750M10C
		PowerFLEX – KVV	Reel of 3000	TL750M10CKVUR	750M10C
	12 V	TO-220 – KCS	Tube of 50	TL750M12CKCS	TL750M12C
PowerFLEX – KVV		Reel of 3000	TL750M12CKVUR	750M12C	

- (1) For the most current package and ordering information, see the Package Option Addendum at the end of this document, or see the TI web site at www.ti.com.
- (2) Package drawings, thermal data, and symbolization are available at www.ti.com/packaging.

FUNCTIONAL BLOCK DIAGRAM

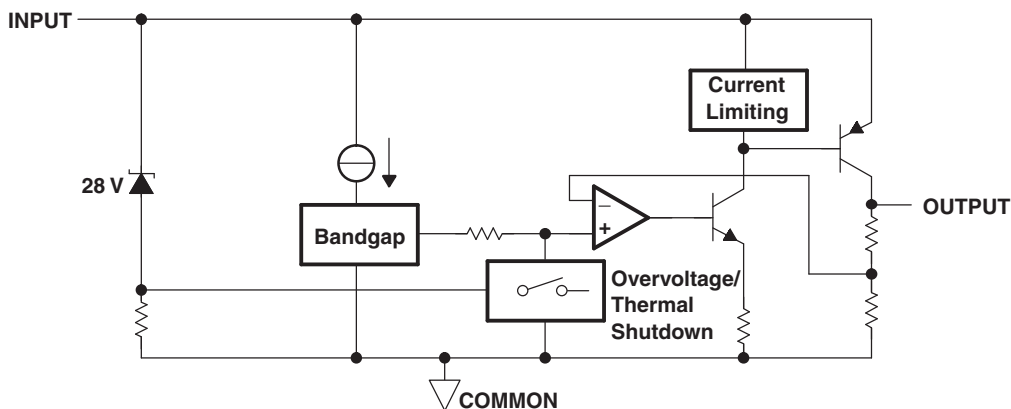

ABSOLUTE MAXIMUM RATINGS⁽¹⁾

over virtual junction temperature range (unless otherwise noted)

		MIN	MAX	UNIT
	Continuous input voltage		26	V
	Transient input voltage (see Figure 3)		60	V
	Continuous reverse input voltage		-15	V
	Transient reverse input voltage	t = 100 ms	-50	V
θ_{JA}	Package thermal impedance ⁽²⁾ ⁽³⁾	KCS package	22	°C/W
		KTT package	25.3	
		KVU package	28	
T_J	Virtual-junction temperature range	0	150	°C
T_{stg}	Storage temperature range	-65	150	°C

- Stresses beyond those listed under "absolute maximum ratings" may cause permanent damage to the device. These are stress ratings only, and functional operation of the device at these or any other conditions beyond those indicated under "recommended operating conditions" is not implied. Exposure to absolute-maximum-rated conditions for extended periods may affect device reliability.
- Maximum power dissipation is a function of $T_J(\text{max})$, θ_{JA} , and T_A . The maximum allowable power dissipation at any allowable ambient temperature is $P_D = (T_J(\text{max}) - T_A)/\theta_{JA}$. Operating at the absolute maximum T_J of 150°C can affect reliability. Due to variation in individual device electrical characteristics and thermal resistance, the built-in thermal-overload protection may be activated at power levels slightly above or below the rated dissipation.
- The package thermal impedance is calculated in accordance with JESD 51.

THERMAL INFORMATION

THERMAL METRIC ⁽¹⁾⁽²⁾		TL750M			UNITS
		KCS (3 PINS)	KVU (3 PINS)	KTT (3 PINS)	
θ_{JA}	Junction-to-ambient thermal resistance	28.7	50.9	27.5	°C/W
θ_{JCTop}	Junction-to-case (top) thermal resistance	59.8	57.9	43.2	
θ_{JB}	Junction-to-board thermal resistance	0.5	34.8	17.3	
ψ_{JT}	Junction-to-top characterization parameter	5.3	6	2.8	
ψ_{JB}	Junction-to-board characterization parameter	0.4	23.7	9.3	
θ_{JCbott}	Junction-to-case (bottom) thermal resistance	0.1	0.4	0.3	

- For more information about traditional and new thermal metrics, see the *IC Package Thermal Metrics* application report, [SPRA953](#).
- For thermal estimates of this device based on PCB copper area, see the [TI PCB Thermal Calculator](#).

RECOMMENDED OPERATING CONDITIONS

		MIN	MAX	UNIT	
V_I	Input voltage	TL750M05	6	26	V
		TL750M08	9	26	
		TL750M10	11	26	
		TL750M12	13	26	
I_O	Output current		750	mA	
T_J	Operating virtual-junction temperature	0	125	°C	

TL750M05 ELECTRICAL CHARACTERISTICS⁽¹⁾

$V_I = 14\text{ V}$, $I_O = 300\text{ mA}$, $T_J = 25^\circ\text{C}$ (unless otherwise noted)

PARAMETER	TEST CONDITIONS	TL750M05			UNIT
		MIN	TYP	MAX	
Output voltage		4.95	5	5.05	V
	$T_J = 0^\circ\text{C to } 125^\circ\text{C}$	4.9		5.1	
Input voltage regulation	$V_I = 9\text{ V to } 16\text{ V}$, $I_O = 250\text{ mA}$		10	25	mV
	$V_I = 6\text{ V to } 26\text{ V}$, $I_O = 250\text{ mA}$		12	50	
Ripple rejection	$V_I = 8\text{ V to } 18\text{ V}$, $f = 120\text{ Hz}$	50	55		dB
Output regulation voltage	$I_O = 5\text{ mA to } 750\text{ mA}$		20	50	mV
Dropout voltage	$I_O = 500\text{ mA}$			0.5	V
	$I_O = 750\text{ mA}$			0.6	
Output noise voltage	$f = 10\text{ Hz to } 100\text{ kHz}$		500		μV
Bias current	$I_O = 750\text{ mA}$		60	75	mA
	$I_O = 10\text{ mA}$			5	

(1) Pulse-testing techniques maintain the junction temperature as close to the ambient temperature as possible. Thermal effects must be taken into account separately. All characteristics are measured with a 0.1- μF capacitor across the input and a 10- μF tantalum capacitor on the output, with equivalent series resistance within the guidelines shown in [Figure 1](#).

TL750M08 ELECTRICAL CHARACTERISTICS⁽¹⁾

$V_I = 14\text{ V}$, $I_O = 300\text{ mA}$, $T_J = 25^\circ\text{C}$ (unless otherwise noted)

PARAMETER	TEST CONDITIONS	TL750M08			UNIT
		MIN	TYP	MAX	
Output voltage		7.92	8	8.08	V
	$T_J = 0^\circ\text{C to } 125^\circ\text{C}$	7.84		8.16	
Input voltage regulation	$V_I = 10\text{ V to } 17\text{ V}$, $I_O = 250\text{ mA}$		12	40	mV
	$V_I = 9\text{ V to } 26\text{ V}$, $I_O = 250\text{ mA}$		15	68	
Ripple rejection	$V_I = 11\text{ V to } 21\text{ V}$, $f = 120\text{ Hz}$	50	55		dB
Output regulation voltage	$I_O = 5\text{ mA to } 750\text{ mA}$		24	80	mV
Dropout voltage	$I_O = 500\text{ mA}$			0.5	V
	$I_O = 750\text{ mA}$			0.6	
Output noise voltage	$f = 10\text{ Hz to } 100\text{ kHz}$		500		μV
Bias current	$I_O = 750\text{ mA}$		60	75	mA
	$I_O = 10\text{ mA}$			5	

(1) Pulse-testing techniques maintain the junction temperature as close to the ambient temperature as possible. Thermal effects must be taken into account separately. All characteristics are measured with a 0.1- μF capacitor across the input and a 10- μF tantalum capacitor on the output, with equivalent series resistance within the guidelines shown in [Figure 1](#).

TL750M10 ELECTRICAL CHARACTERISTICS⁽¹⁾
 $V_I = 14\text{ V}$, $I_O = 300\text{ mA}$, $T_J = 25^\circ\text{C}$ (unless otherwise noted)

PARAMETER	TEST CONDITIONS	TL750M10			UNIT
		MIN	TYP	MAX	
Output voltage		9.9	10	10.1	V
	$T_J = 0^\circ\text{C to } 125^\circ\text{C}$	9.8		10.2	
Input voltage regulation	$V_I = 12\text{ V to } 18\text{ V}$, $I_O = 250\text{ mA}$		15	43	mV
	$V_I = 11\text{ V to } 26\text{ V}$, $I_O = 250\text{ mA}$		20	75	
Ripple rejection	$V_I = 13\text{ V to } 23\text{ V}$, $f = 120\text{ Hz}$	50	55		dB
Output regulation voltage	$I_O = 5\text{ mA to } 750\text{ mA}$		30	100	mV
Dropout voltage	$I_O = 500\text{ mA}$			0.5	V
	$I_O = 750\text{ mA}$			0.6	
Output noise voltage	$f = 10\text{ Hz to } 100\text{ kHz}$		1000		μV
Bias current	$I_O = 750\text{ mA}$		60	75	mA
	$I_O = 10\text{ mA}$			5	

(1) Pulse-testing techniques maintain the junction temperature as close to the ambient temperature as possible. Thermal effects must be taken into account separately. All characteristics are measured with a 0.1- μF capacitor across the input and a 10- μF tantalum capacitor on the output, with equivalent series resistance within the guidelines shown in [Figure 1](#).

TL750M12 ELECTRICAL CHARACTERISTICS⁽¹⁾
 $V_I = 14\text{ V}$, $I_O = 300\text{ mA}$, $T_J = 25^\circ\text{C}$ (unless otherwise noted)

PARAMETER	TEST CONDITIONS	TL750M12			UNIT
		MIN	TYP	MAX	
Output voltage		11.88	12	12.12	V
	$T_J = 0^\circ\text{C to } 125^\circ\text{C}$	11.76		12.24	
Input voltage regulation	$V_I = 14\text{ V to } 19\text{ V}$, $I_O = 250\text{ mA}$		15	43	mV
	$V_I = 13\text{ V to } 26\text{ V}$, $I_O = 250\text{ mA}$		20	78	
Ripple rejection	$V_I = 13\text{ V to } 23\text{ V}$, $f = 120\text{ Hz}$	50	55		dB
Output regulation voltage	$I_O = 5\text{ mA to } 750\text{ mA}$		30	120	mV
Dropout voltage	$I_O = 500\text{ mA}$			0.5	V
	$I_O = 750\text{ mA}$			0.6	
Output noise voltage	$f = 10\text{ Hz to } 100\text{ kHz}$		1000		μV
Bias current	$I_O = 750\text{ mA}$		60	75	mA
	$I_O = 10\text{ mA}$			5	

(1) Pulse-testing techniques maintain the junction temperature as close to the ambient temperature as possible. Thermal effects must be taken into account separately. All characteristics are measured with a 0.1- μF capacitor across the input and a 10- μF tantalum capacitor on the output, with equivalent series resistance within the guidelines shown in [Figure 1](#).

PARAMETER MEASUREMENT INFORMATION

The TL750Mxx is a low-dropout regulator. This means that the capacitance loading is important to the performance of the regulator because it is a vital part of the control loop. The capacitor value and the equivalent series resistance (ESR) both affect the control loop and must be defined for the load range and the temperature range. Figure 1 and Figure 2 can establish the capacitance value and ESR range for the best regulator performance.

Figure 1 shows the recommended range of ESR for a given load with a 10-μF capacitor on the output. This figure also shows a maximum ESR limit of 2 Ω and a load-dependent minimum ESR limit.

For applications with varying loads, the lightest load condition should be chosen because it is the worst case. Figure 2 shows the relationship of the reciprocal of ESR to the square root of the capacitance with a minimum capacitance limit of 10 μF and a maximum ESR limit of 2 Ω. This figure establishes the amount that the minimum ESR limit shown in Figure 1 can be adjusted for different capacitor values.

For example, where the minimum load needed is 200 mA, Figure 1 suggests an ESR range of 0.8 Ω to 2 Ω for 10 μF. Figure 2 shows that changing the capacitor from 10 μF to 400 μF can change the ESR minimum by greater than 3/0.5 (or 6). Therefore, the new minimum ESR value is 0.8/6 (or 0.13 Ω). This allows an ESR range of 0.13 Ω to 2 Ω, achieving an expanded ESR range by using a larger capacitor at the output. For better stability in low-current applications, a small resistance placed in series with the capacitor (see Table 1) is recommended, so that ESRs better approximate those shown in Figure 1 and Figure 2.

Table 1. Compensation for Increased Stability at Low Currents

MANUFACTURER	CAPACITANCE	ESR TYP	PART NUMBER	ADDITIONAL RESISTANCE
AVX	15 μF	0.9 Ω	TAJB156M010S	1 Ω
KEMET	33 μF	0.6 Ω	T491D336M010 AS	0.5 Ω

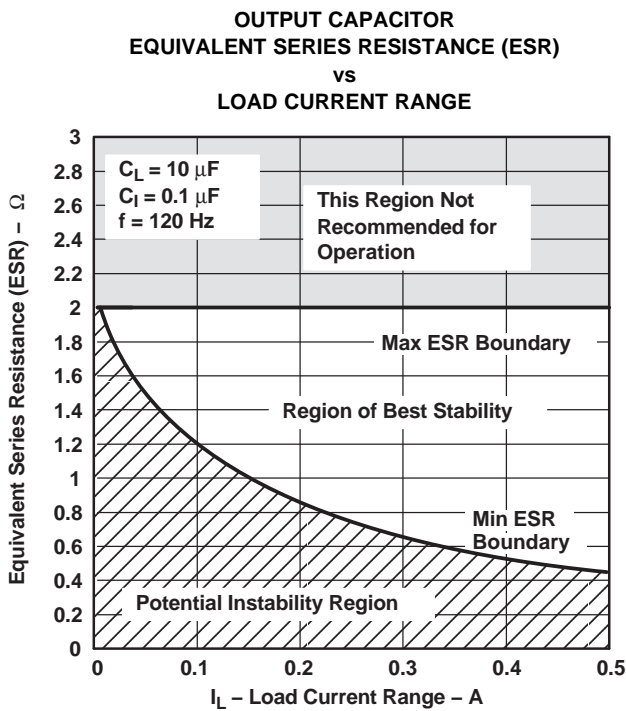
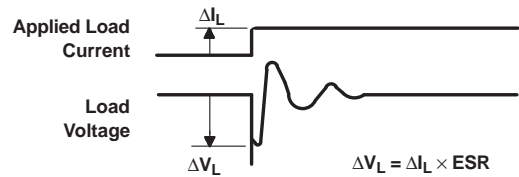

Figure 1.

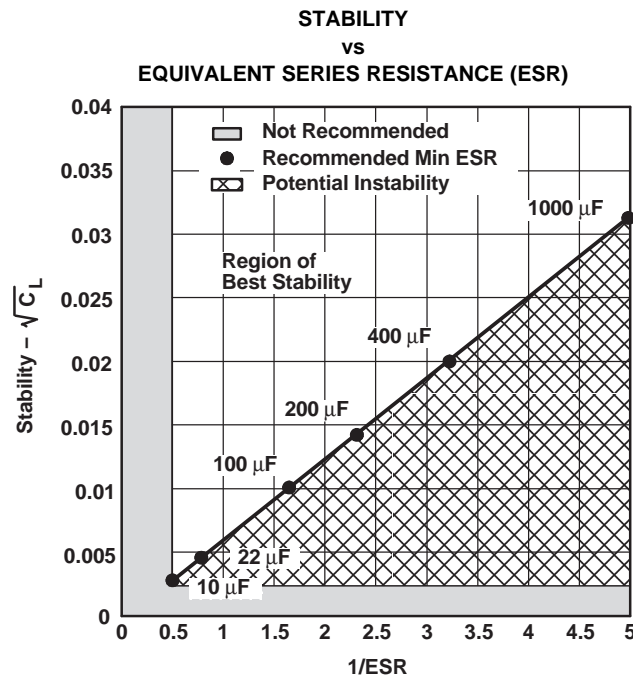

Figure 2.

TYPICAL CHARACTERISTICS

Table 2. Table of Graphs

		FIGURE
Transient input voltage vs Time		3
Output voltage vs Input voltage		4
Input current vs Input voltage	$I_O = 10\text{ mA}$	5
	$I_O = 100\text{ mA}$	6
Dropout voltage vs Output current		7
Quiescent voltage vs Output current		8
Load transient response		9
Line transient response		10

TRANSIENT INPUT VOLTAGE
vs
TIME

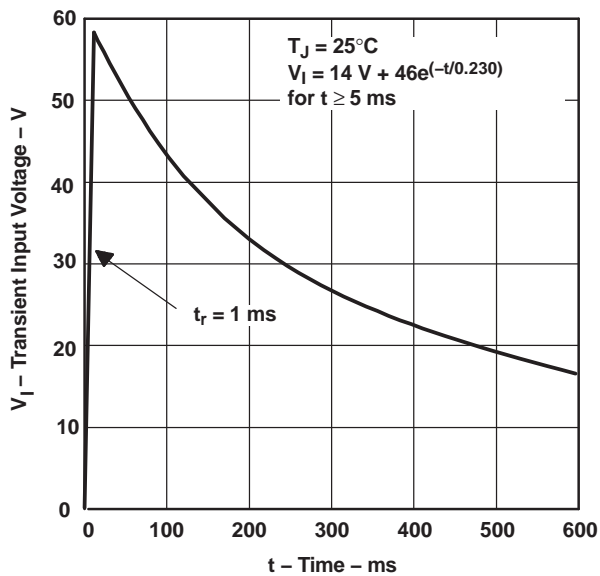

Figure 3.

OUTPUT VOLTAGE
vs
INPUT VOLTAGE

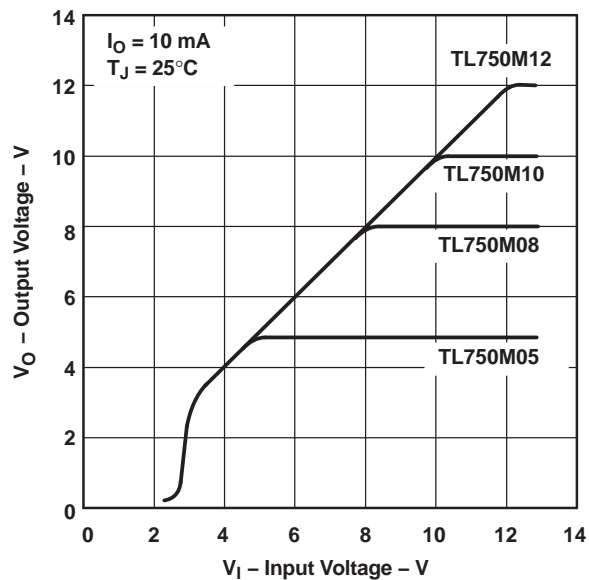

Figure 4.

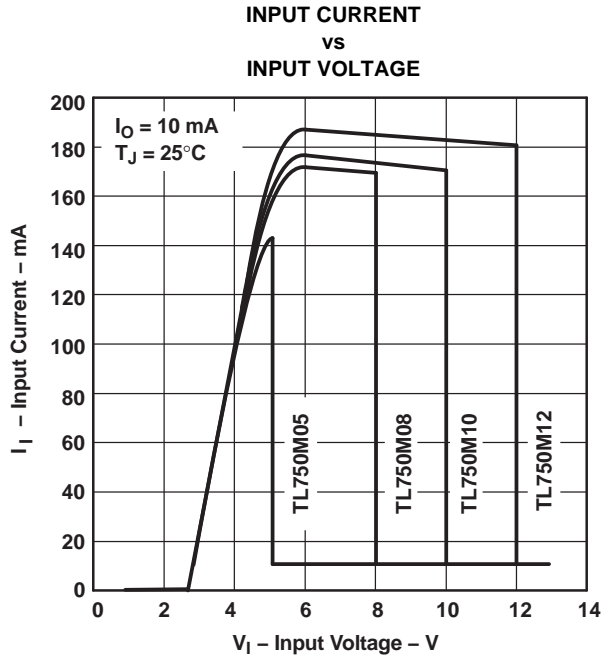

Figure 5.

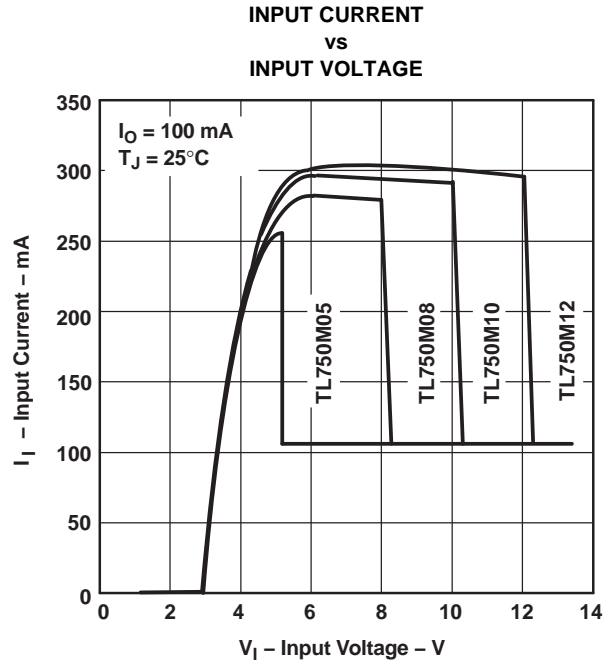

Figure 6.

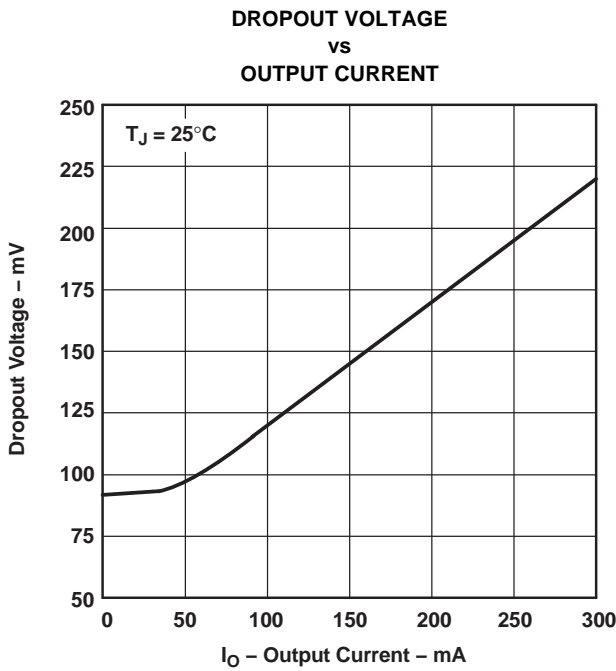

Figure 7.

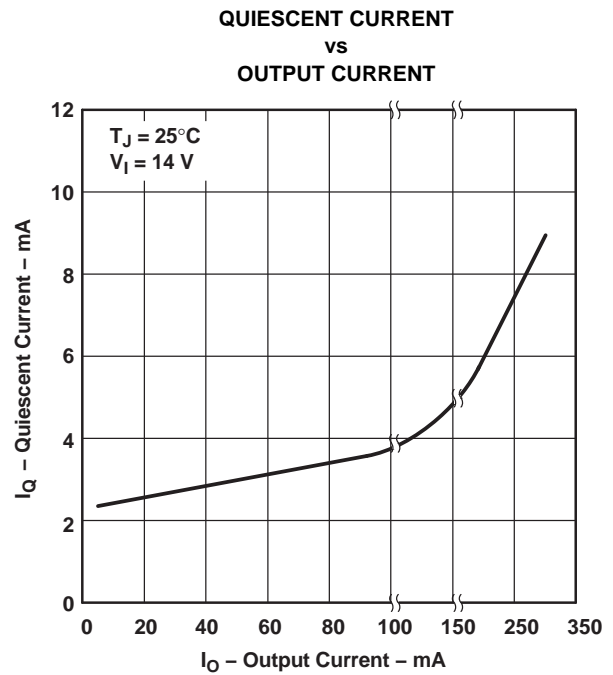

Figure 8.

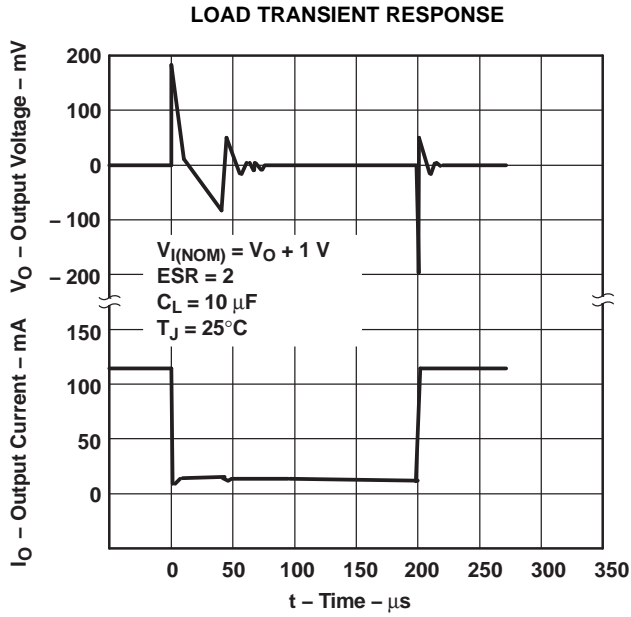

Figure 9.

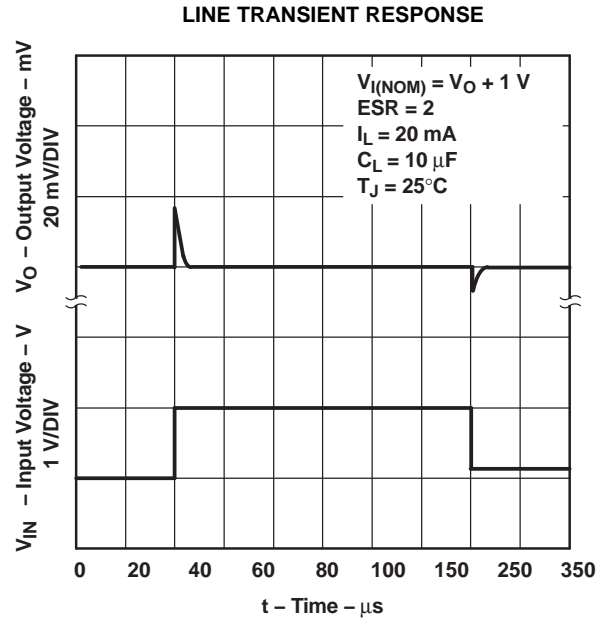

Figure 10.

PACKAGING INFORMATION

Orderable Device	Status (1)	Package Type	Package Drawing	Pins	Package Qty	Eco Plan (2)	Lead finish/ Ball material (6)	MSL Peak Temp (3)	Op Temp (°C)	Device Marking (4/5)	Samples
TL750M05CKCSE3	ACTIVE	TO-220	KCS	3	50	RoHS & Green	SN	N / A for Pkg Type	0 to 125	TL750M05C	Samples
TL750M05CKTTR	ACTIVE	DDPAK/ TO-263	KTT	3	500	RoHS & Green	SN	Level-3-245C-168 HR	0 to 125	TL750M05C	Samples
TL750M05CKVURG3	ACTIVE	TO-252	KVU	3	2500	RoHS & Green	SN	Level-3-260C-168 HR	0 to 125	50M05C	Samples
TL750M08CKCSE3	ACTIVE	TO-220	KCS	3	50	RoHS & Green	SN	N / A for Pkg Type	0 to 125	TL750M08C	Samples
TL750M08CKVURG3	ACTIVE	TO-252	KVU	3	2500	RoHS & Green	SN	Level-3-260C-168 HR	0 to 125	50M08C	Samples
TL750M10CKCSE3	ACTIVE	TO-220	KCS	3	50	RoHS & Green	SN	N / A for Pkg Type	0 to 125	TL750M10C	Samples
TL750M10CKVURG3	ACTIVE	TO-252	KVU	3	2500	RoHS & Green	SN	Level-3-260C-168 HR	0 to 125	50M10C	Samples
TL750M12CKCSE3	ACTIVE	TO-220	KCS	3	50	RoHS & Green	SN	N / A for Pkg Type	0 to 125	TL750M12C	Samples
TL750M12CKVURG3	ACTIVE	TO-252	KVU	3	2500	RoHS & Green	SN	Level-3-260C-168 HR	0 to 125	50M12C	Samples

(1) The marketing status values are defined as follows:

ACTIVE: Product device recommended for new designs.

LIFEBUY: TI has announced that the device will be discontinued, and a lifetime-buy period is in effect.

NRND: Not recommended for new designs. Device is in production to support existing customers, but TI does not recommend using this part in a new design.

PREVIEW: Device has been announced but is not in production. Samples may or may not be available.

OBSELETE: TI has discontinued the production of the device.

(2) **RoHS:** TI defines "RoHS" to mean semiconductor products that are compliant with the current EU RoHS requirements for all 10 RoHS substances, including the requirement that RoHS substance do not exceed 0.1% by weight in homogeneous materials. Where designed to be soldered at high temperatures, "RoHS" products are suitable for use in specified lead-free processes. TI may reference these types of products as "Pb-Free".

RoHS Exempt: TI defines "RoHS Exempt" to mean products that contain lead but are compliant with EU RoHS pursuant to a specific EU RoHS exemption.

Green: TI defines "Green" to mean the content of Chlorine (Cl) and Bromine (Br) based flame retardants meet JS709B low halogen requirements of <=1000ppm threshold. Antimony trioxide based flame retardants must also meet the <=1000ppm threshold requirement.

(3) MSL, Peak Temp. - The Moisture Sensitivity Level rating according to the JEDEC industry standard classifications, and peak solder temperature.

(4) There may be additional marking, which relates to the logo, the lot trace code information, or the environmental category on the device.

(5) Multiple Device Markings will be inside parentheses. Only one Device Marking contained in parentheses and separated by a "-" will appear on a device. If a line is indented then it is a continuation of the previous line and the two combined represent the entire Device Marking for that device.

(6) Lead finish/Ball material - Orderable Devices may have multiple material finish options. Finish options are separated by a vertical ruled line. Lead finish/Ball material values may wrap to two lines if the finish value exceeds the maximum column width.

Important Information and Disclaimer:The information provided on this page represents TI's knowledge and belief as of the date that it is provided. TI bases its knowledge and belief on information provided by third parties, and makes no representation or warranty as to the accuracy of such information. Efforts are underway to better integrate information from third parties. TI has taken and continues to take reasonable steps to provide representative and accurate information but may not have conducted destructive testing or chemical analysis on incoming materials and chemicals. TI and TI suppliers consider certain information to be proprietary, and thus CAS numbers and other limited information may not be available for release.

In no event shall TI's liability arising out of such information exceed the total purchase price of the TI part(s) at issue in this document sold by TI to Customer on an annual basis.

OTHER QUALIFIED VERSIONS OF TL750M :

- Automotive: [TL750M-Q1](#)

NOTE: Qualified Version Definitions:

- Automotive - Q100 devices qualified for high-reliability automotive applications targeting zero defects

TAPE AND REEL INFORMATION

QUADRANT ASSIGNMENTS FOR PIN 1 ORIENTATION IN TAPE

*All dimensions are nominal

Device	Package Type	Package Drawing	Pins	SPQ	Reel Diameter (mm)	Reel Width W1 (mm)	A0 (mm)	B0 (mm)	K0 (mm)	P1 (mm)	W (mm)	Pin1 Quadrant
TL750M05CKTTR	DDPAK/ TO-263	KTT	3	500	330.0	24.4	10.8	16.3	5.11	16.0	24.0	Q2
TL750M05CKVURG3	TO-252	KVU	3	2500	330.0	16.4	6.9	10.5	2.7	8.0	16.0	Q2
TL750M08CKVURG3	TO-252	KVU	3	2500	330.0	16.4	6.9	10.5	2.7	8.0	16.0	Q2
TL750M10CKVURG3	TO-252	KVU	3	2500	330.0	16.4	6.9	10.5	2.7	8.0	16.0	Q2
TL750M12CKVURG3	TO-252	KVU	3	2500	330.0	16.4	6.9	10.5	2.7	8.0	16.0	Q2

TAPE AND REEL BOX DIMENSIONS



*All dimensions are nominal

Device	Package Type	Package Drawing	Pins	SPQ	Length (mm)	Width (mm)	Height (mm)
TL750M05CKTTR	DDPAK/TO-263	KTT	3	500	340.0	340.0	38.0
TL750M05CKVURG3	TO-252	KVU	3	2500	340.0	340.0	38.0
TL750M08CKVURG3	TO-252	KVU	3	2500	340.0	340.0	38.0
TL750M10CKVURG3	TO-252	KVU	3	2500	340.0	340.0	38.0
TL750M12CKVURG3	TO-252	KVU	3	2500	340.0	340.0	38.0

TUBE

*All dimensions are nominal

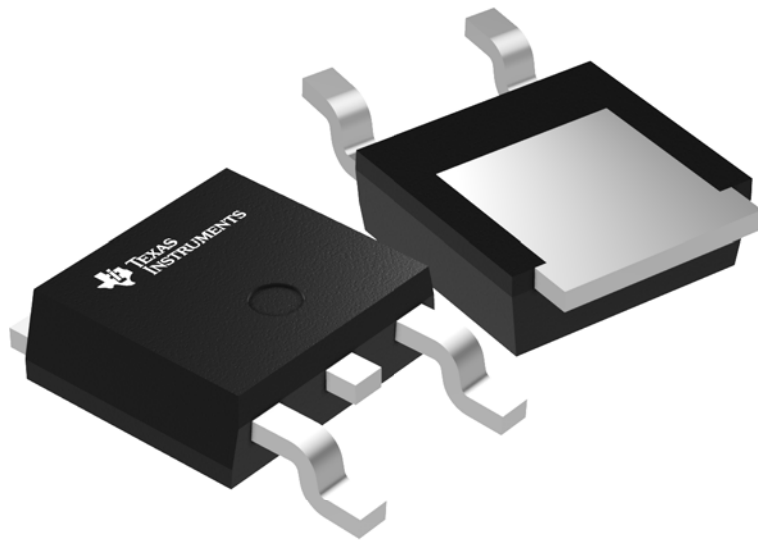
Device	Package Name	Package Type	Pins	SPQ	L (mm)	W (mm)	T (μm)	B (mm)
TL750M05CKCSE3	KCS	TO-220	3	50	532	34.1	700	9.6
TL750M08CKCSE3	KCS	TO-220	3	50	532	34.1	700	9.6
TL750M10CKCSE3	KCS	TO-220	3	50	532	34.1	700	9.6
TL750M12CKCSE3	KCS	TO-220	3	50	532	34.1	700	9.6



Images above are just a representation of the package family, actual package may vary.
Refer to the product data sheet for package details.



PACKAGE OUTLINE

KVVU0003A

TO-252 - 2.52 mm max height

TO-252

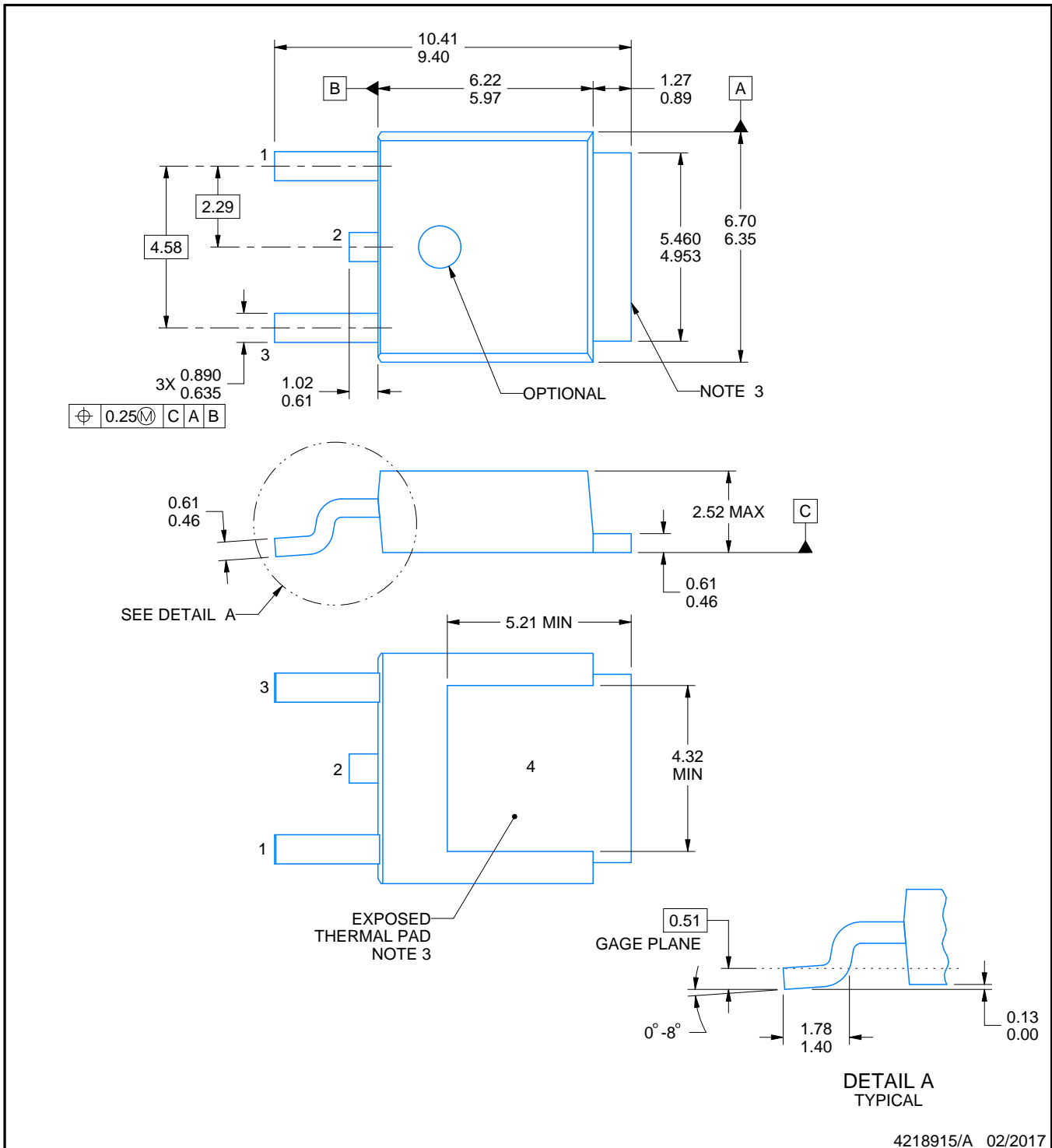

NOTES:

1. All linear dimensions are in millimeters. Any dimensions in parenthesis are for reference only. Dimensioning and tolerancing per ASME Y14.5M.
2. This drawing is subject to change without notice.
3. Shape may vary per different assembly sites.
4. Reference JEDEC registration TO-252.

EXAMPLE BOARD LAYOUT

KVU0003A

TO-252 - 2.52 mm max height

TO-252

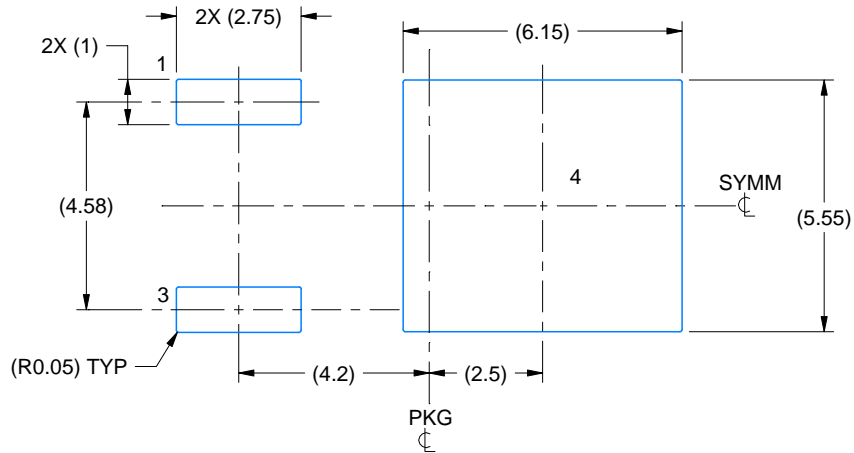

LAND PATTERN EXAMPLE
EXPOSED METAL SHOWN
SCALE:6X

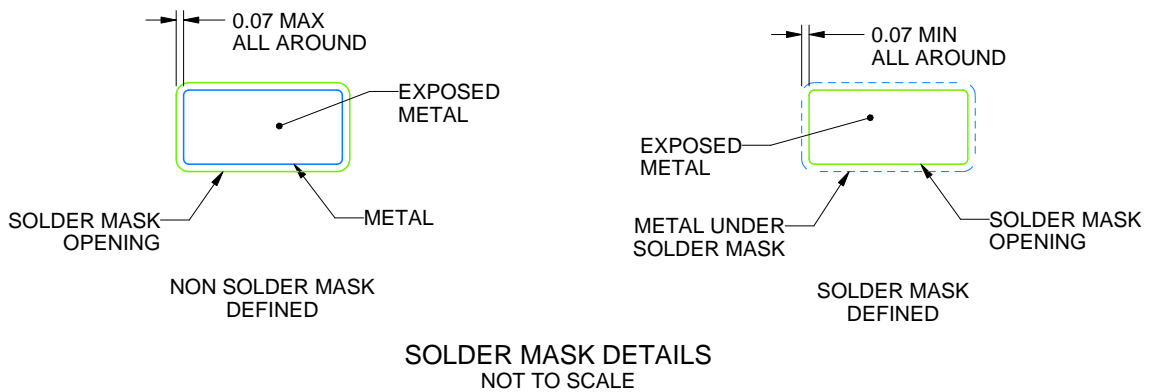

SOLDER MASK DETAILS
NOT TO SCALE

4218915/A 02/2017

NOTES: (continued)

5. This package is designed to be soldered to a thermal pad on the board. For more information, see Texas Instruments literature numbers SLMA002(www.ti.com/lit/slm002) and SLMA004 (www.ti.com/lit/slma004).
6. Vias are optional depending on application, refer to device data sheet. It is recommended that vias under paste be filled, plugged or tented.

EXAMPLE STENCIL DESIGN

KVU0003A

TO-252 - 2.52 mm max height

TO-252

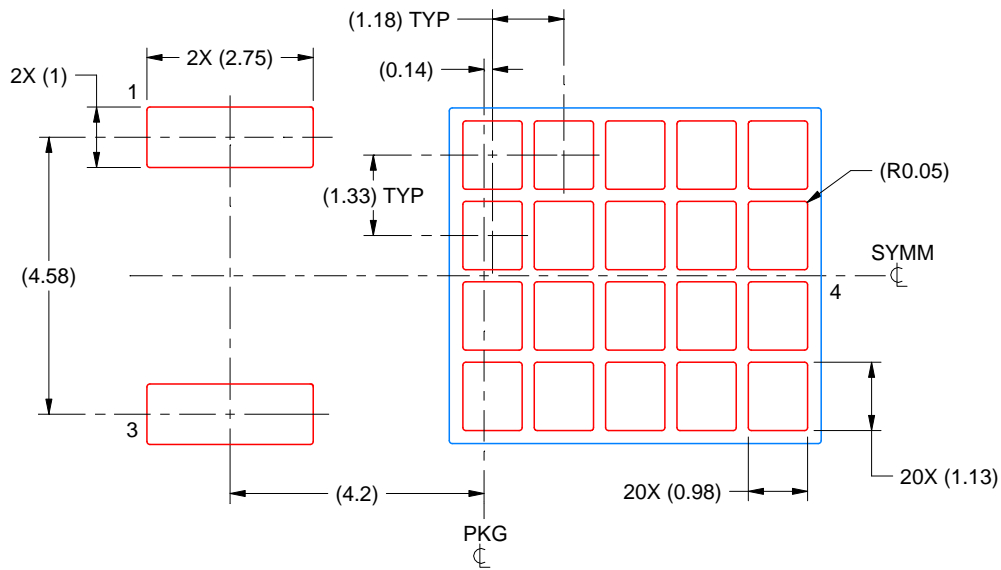

SOLDER PASTE EXAMPLE
BASED ON 0.125 mm THICK STENCIL

EXPOSED PAD
65% PRINTED SOLDER COVERAGE BY AREA
SCALE:8X

4218915/A 02/2017

NOTES: (continued)

7. Laser cutting apertures with trapezoidal walls and rounded corners may offer better paste release. IPC-7525 may have alternate design recommendations.
8. Board assembly site may have different recommendations for stencil design.

KTT (R-PSFM-G3)

PLASTIC FLANGE-MOUNT PACKAGE

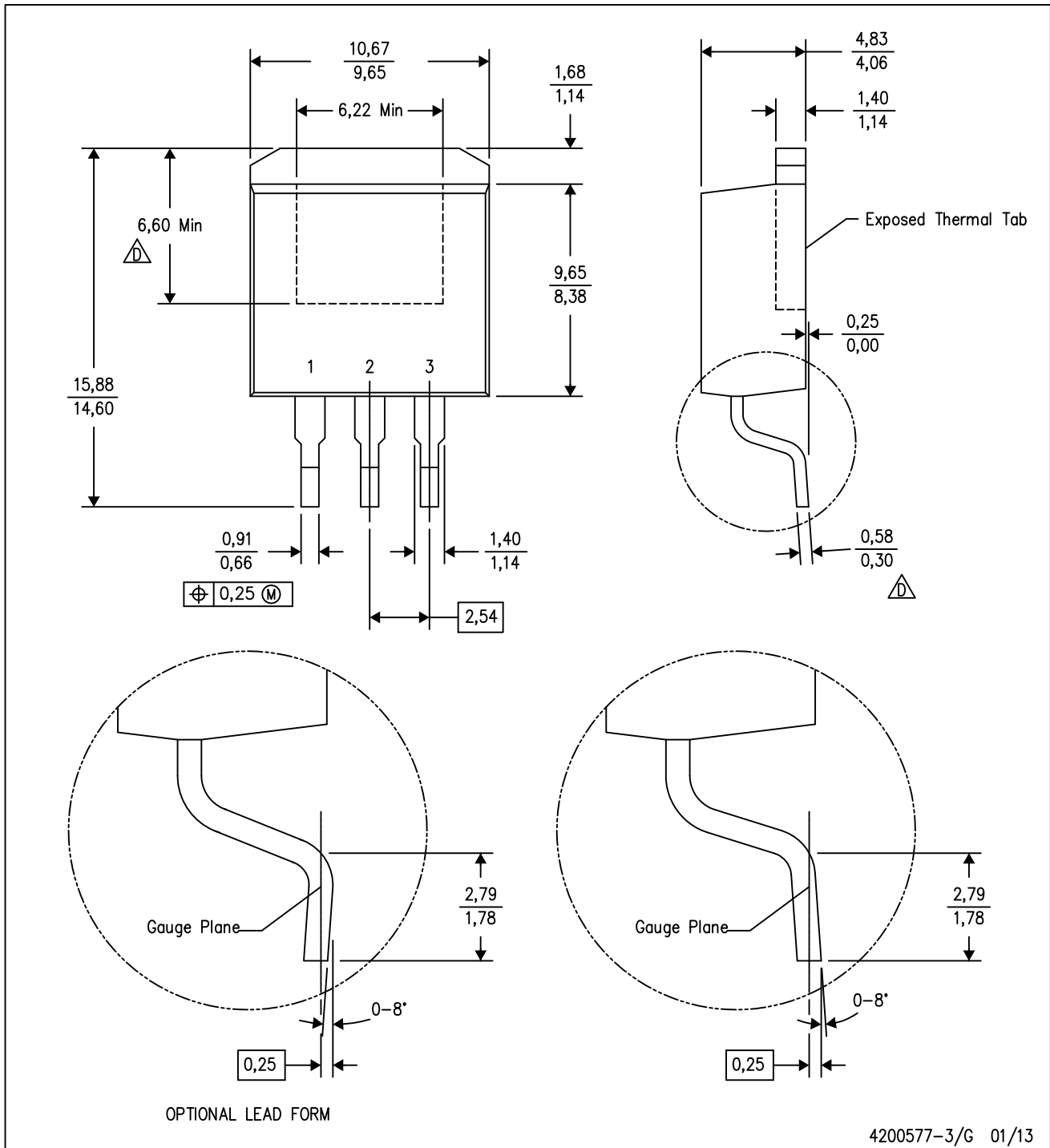

- NOTES:
- A. All linear dimensions are in millimeters.
 - B. This drawing is subject to change without notice.
 - C. Body dimensions do not include mold flash or protrusion. Mold flash or protrusion not to exceed 0.005 (0,13) per side.
- Falls within JEDEC TO-263 variation AA, except minimum lead thickness and minimum exposed pad length.

KCS0003B

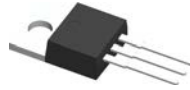

PACKAGE OUTLINE

TO-220 - 19.65 mm max height

TO-220

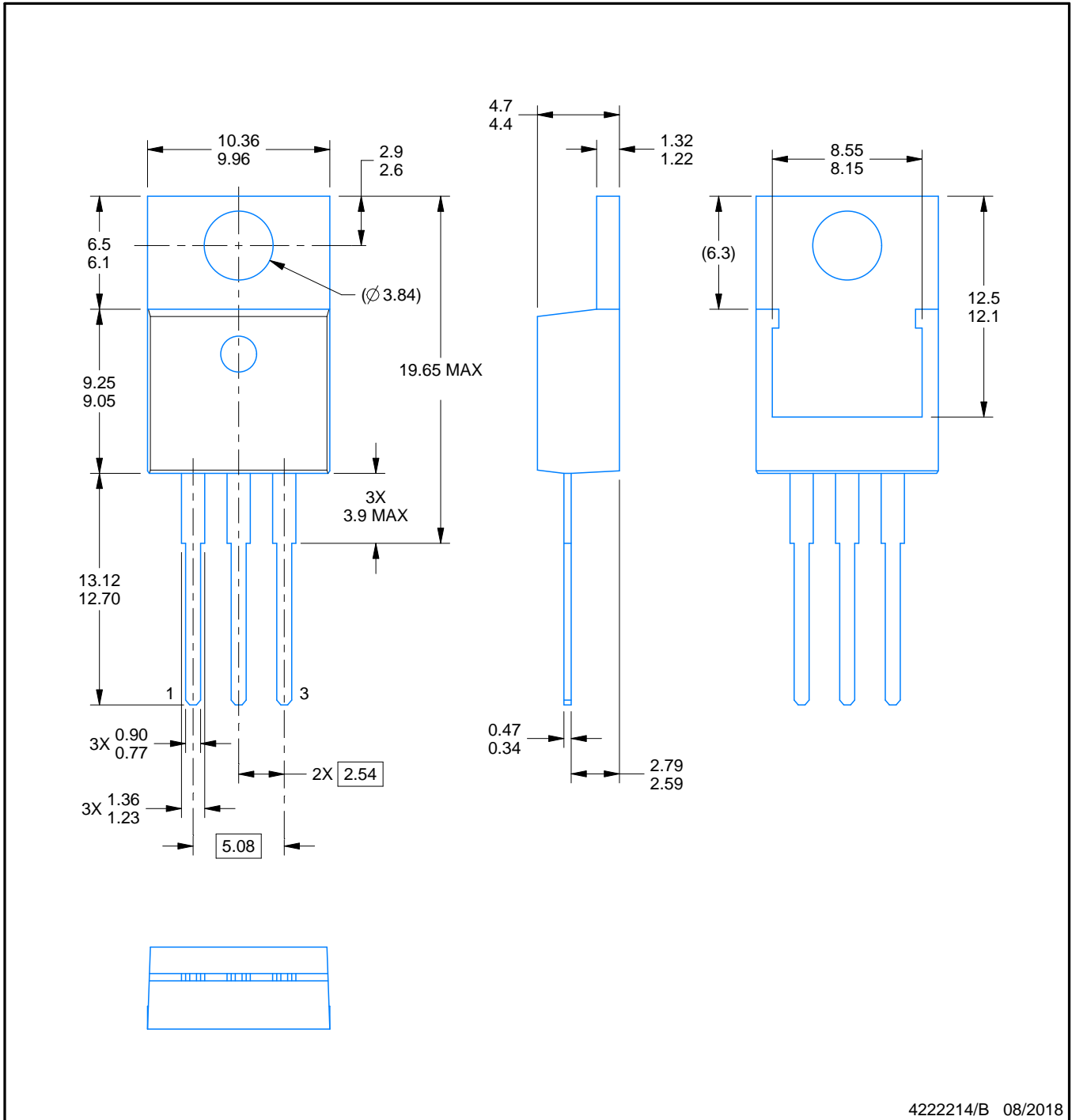

4222214/B 08/2018

NOTES:

1. Dimensions are in millimeters. Any dimension in brackets or parenthesis are for reference only. Dimensioning and tolerancing per ASME Y14.5M.
2. This drawing is subject to change without notice.
3. Reference JEDEC registration TO-220.

EXAMPLE BOARD LAYOUT

KCS0003B

TO-220 - 19.65 mm max height

TO-220

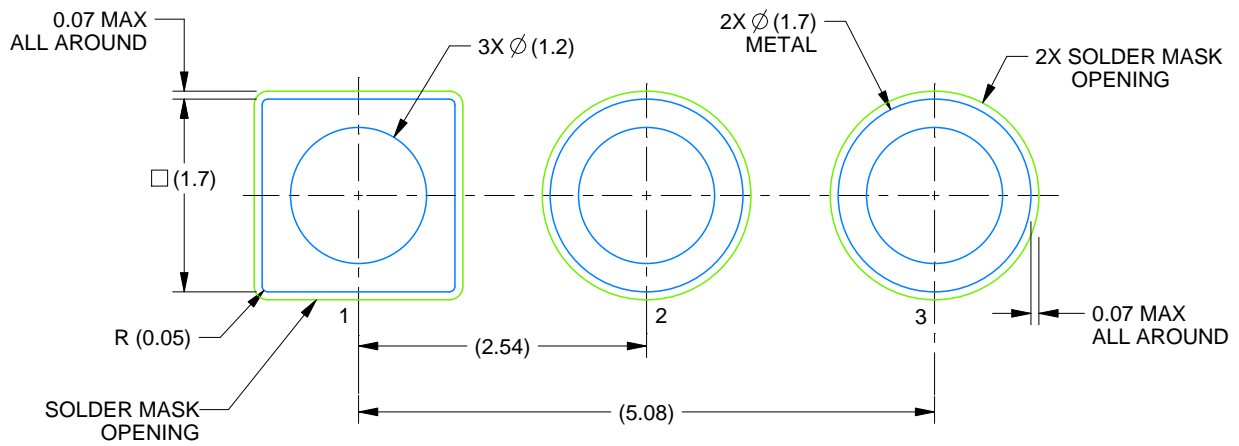

LAND PATTERN EXAMPLE
NON-SOLDER MASK DEFINED
SCALE:15X

4222214/B 08/2018

IMPORTANT NOTICE AND DISCLAIMER

TI PROVIDES TECHNICAL AND RELIABILITY DATA (INCLUDING DATA SHEETS), DESIGN RESOURCES (INCLUDING REFERENCE DESIGNS), APPLICATION OR OTHER DESIGN ADVICE, WEB TOOLS, SAFETY INFORMATION, AND OTHER RESOURCES "AS IS" AND WITH ALL FAULTS, AND DISCLAIMS ALL WARRANTIES, EXPRESS AND IMPLIED, INCLUDING WITHOUT LIMITATION ANY IMPLIED WARRANTIES OF MERCHANTABILITY, FITNESS FOR A PARTICULAR PURPOSE OR NON-INFRINGEMENT OF THIRD PARTY INTELLECTUAL PROPERTY RIGHTS.

These resources are intended for skilled developers designing with TI products. You are solely responsible for (1) selecting the appropriate TI products for your application, (2) designing, validating and testing your application, and (3) ensuring your application meets applicable standards, and any other safety, security, regulatory or other requirements.

These resources are subject to change without notice. TI grants you permission to use these resources only for development of an application that uses the TI products described in the resource. Other reproduction and display of these resources is prohibited. No license is granted to any other TI intellectual property right or to any third party intellectual property right. TI disclaims responsibility for, and you will fully indemnify TI and its representatives against, any claims, damages, costs, losses, and liabilities arising out of your use of these resources.

TI's products are provided subject to [TI's Terms of Sale](#) or other applicable terms available either on ti.com or provided in conjunction with such TI products. TI's provision of these resources does not expand or otherwise alter TI's applicable warranties or warranty disclaimers for TI products.

TI objects to and rejects any additional or different terms you may have proposed.

Mailing Address: Texas Instruments, Post Office Box 655303, Dallas, Texas 75265
Copyright © 2022, Texas Instruments Incorporated

Looking for pricing, stock, or lifecycle information?

Click below to explore more details on WIN SOURCE:

 [View TL750M05CKVURG3 on WIN SOURCE](#)

 [Texas Instruments](#) Information

Optimize Your Supply Chain with WIN SOURCE Solutions

-  Global Sourcing Solution
-  Obsolete Management
-  Cost Control Management
-  Shortage Management
-  Alternative Solution
-  Excess Inventory Management