

TLE4267

5 V Low Drop Voltage Regulator



Features

- Output voltage tolerance $\leq \pm 2\%$
- 400 mA output current capability
- Low-drop voltage
- Very low standby current consumption
- Input voltage up to 40 V
- Overvoltage protection up to 60 V (≤ 400 ms)
- Reset function down to 1 V output voltage
- ESD protection up to 2000 V
- Adjustable reset time
- On/off logic
- Overtemperature protection
- Reverse polarity protection
- Short-circuit proof
- Wide temperature range
- Suitable for use in automotive electronics
- Green Product (RoHS compliant)

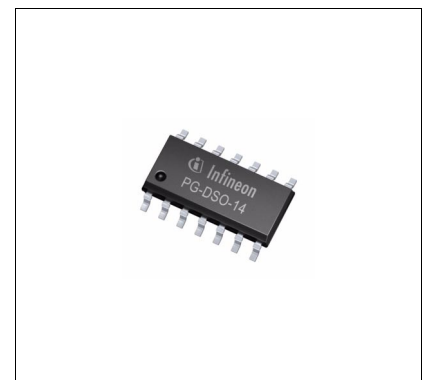
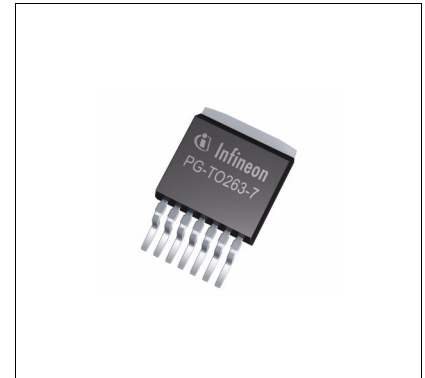

Potential applications

- Automotive applications directly connected to the battery
- Applications with a protected power supply for off-board load

Product validation

Qualified for automotive applications. Product validation according to AEC-Q100/101.

Description

TLE4267 is a 5 V low drop voltage regulator for automotive applications in the PG-T0263-7 or PG-DSO-14 package. It supplies an output current of greater than 400 mA. The IC is short-circuit-proof and has an overtemperature protection circuit.

TLE4267
5 V Low Drop Voltage Regulator



Type	Package	Marking
TLE4267G	PG-TO263-7	TLE4267
TLE4267GM	PG-DSO-14	TLE4267

Table of contents

	Features	1
	Potential applications	1
	Product validation	1
	Description	1
	Table of contents	3
1	Block diagram	4
2	Pin configuration	5
2.1	Pin assignment PG-TO263-7	5
2.2	Pin assignment PG-DSO-14	6
3	General product characteristics	7
3.1	Absolute maximum ratings	7
3.2	Functional range	8
3.3	Thermal resistance	8
4	Functional description	9
4.1	Electrical characteristics	10
4.2	Typical performance characteristics	12
5	Test and application circuit	15
6	Package outlines	18
7	Revision history	19

Block diagram

1 Block diagram

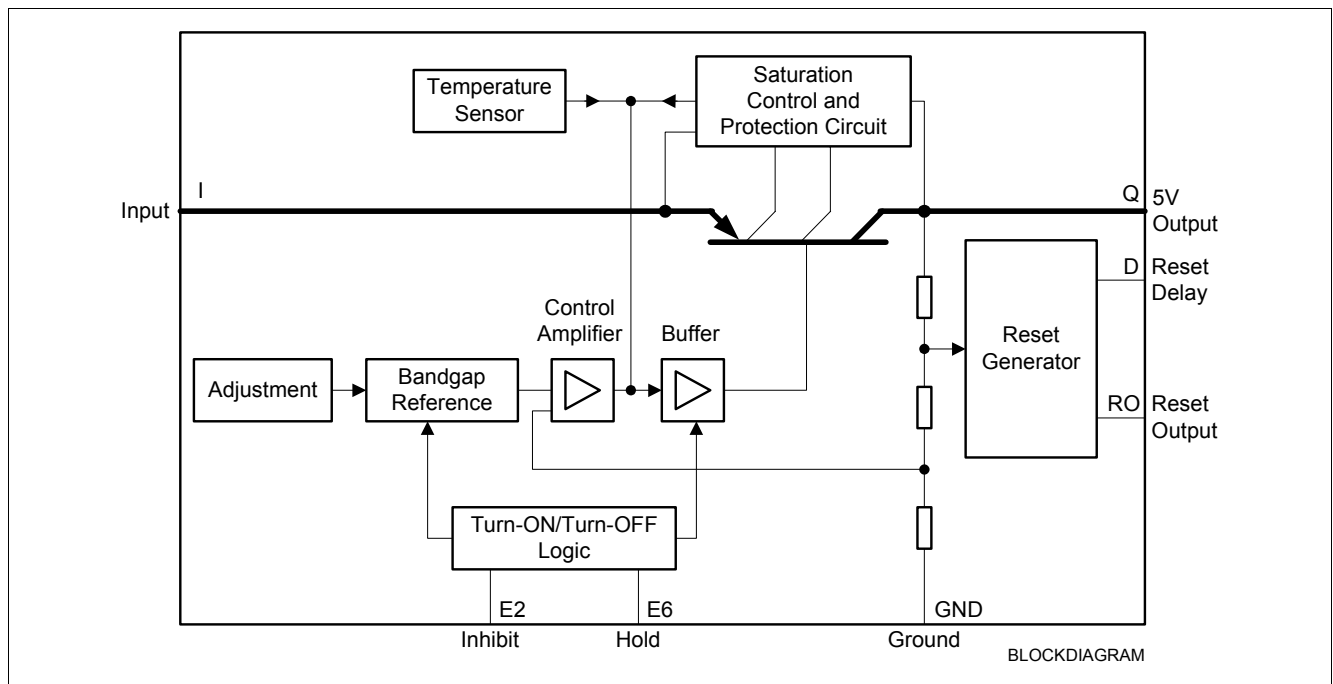

Figure 1 Block diagram TLE4267

Pin configuration

2 Pin configuration

2.1 Pin assignment PG-TO263-7

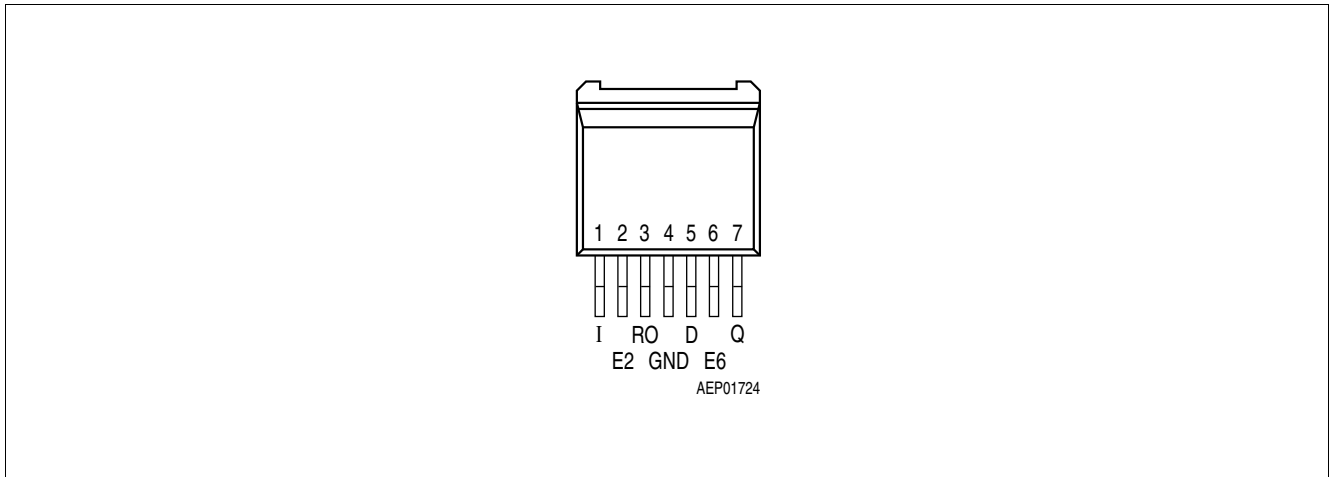

Figure 2 Pin configuration (top view)

Table 1 Pin definitions and functions

Pin	Symbol	Function
1	I	Input; block to ground directly at the IC by a ceramic capacitor
2	E2	Inhibit; device is turned on by High signal on this pin; internal pull-down resistor of 100 kΩ
3	RO	Reset Output; open-collector output internally connected to the output via a resistor of 30 kΩ
4	GND	Ground; connected to rear of chip
5	D	Reset Delay; connect via capacitor to GND
6	E6	Hold; see Table 6 for function; this input is connected to output voltage via a pull-up resistor of 50 kΩ
7	Q	5 V Output; block to GND with 22 μF capacitor, ESR < 3 Ω

Pin configuration

2.2 Pin assignment PG-DSO-14

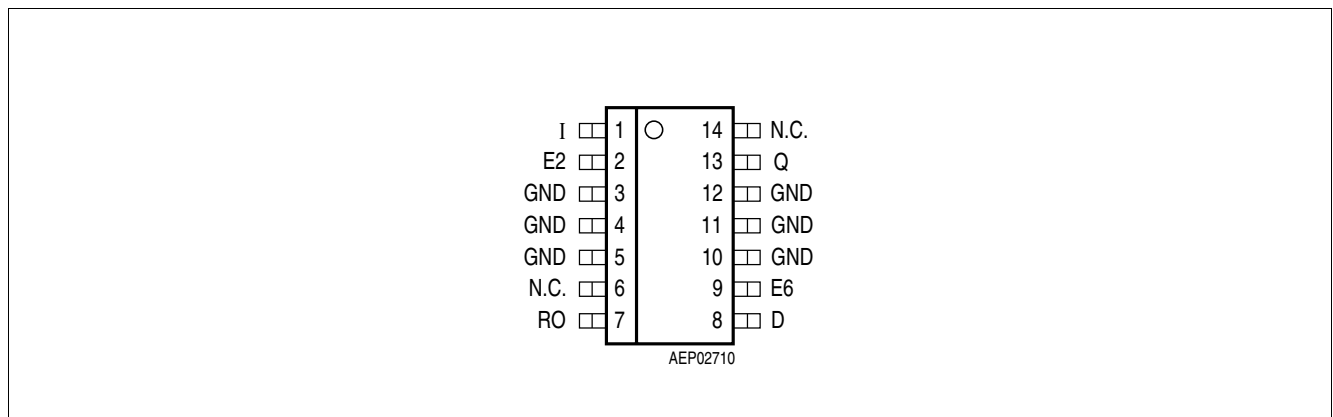

Figure 3 Pin configuration (top view)

Table 2 Pin definitions and functions

Pin	Symbol	Function
1	I	Input; block to ground directly at the IC by a ceramic capacitor
2	E2	Inhibit; device is turned on by High signal on this pin; internal pull-down resistor of 100 k Ω
7	RO	Reset Output; open-collector output internally connected to the output via a resistor of 30 k Ω
3, 4, 5, 10, 11, 12	GND	Ground; connected to rear of chip
8	D	Reset Delay; connect with capacitor to GND for setting delay
9	E6	Hold; see Table 6 for function; this input is connected to output voltage via a pull-up resistor of 50 k Ω
13	Q	5 V Output; block to GND with 22 μ F capacitor, ESR \leq 3 Ω
6, 14	N.C.	Not Connected

General product characteristics

3 General product characteristics

3.1 Absolute maximum ratings

Table 3 Absolute maximum ratings¹⁾

$T_J = -40$ to 150°C

Parameter	Symbol	Values			Unit	Note or Test Condition	Number
		Min.	Typ.	Max.			
Input							
Voltage	V_I	-42	-	42	V	-	P_3.1.1
Voltage	V_I	-	-	60	V	$t \leq 400$ ms	P_3.1.2
Current	I_I	-	-	-	-	Internally limited	P_3.1.3
Reset output							
Voltage	V_{RO}	-0.3	-	7	V	-	P_3.1.4
Current	I_{RO}	-	-	-	-	Internally limited	P_3.1.5
Reset delay							
Voltage	V_D	-0.3	-	42	V	-	P_3.1.6
Current	I_D	-	-	-	-	-	P_3.1.7
Output							
Voltage	V_Q	-0.3	-	7	V	-	P_3.1.8
Current	I_Q	-	-	-	-	Internally limited	P_3.1.9
Inhibit							
Voltage	V_{E2}	-42	-	42	V	-	P_3.1.10
Current	I_{E2}	-5	-	5	mA	$t \leq 400$ ms	P_3.1.11
Hold							
Voltage	V_{E6}	-0.3	-	7	V	-	P_3.1.12
Current	I_{E6}	-	-	-	mA	Internally limited	P_3.1.13
GND							
Current	I_{GND}	-0.5	-	-	A	-	P_3.1.14
Temperatures							
Junction temperature	T_J	-	-	150	$^\circ\text{C}$	-	P_3.1.15
Storage temperature	T_{stg}	-50	-	150	$^\circ\text{C}$	-	P_3.1.16

1) Not subject to production test, specified by design.

Notes

1. Stresses above the ones listed here may cause permanent damage to the device. Exposure to absolute maximum rating conditions for extended periods may affect device reliability.
2. Integrated protection functions are designed to prevent IC destruction under fault conditions described in the data sheet. Fault conditions are considered as outside normal operating range. Protection functions are not designed for continuous repetitive operation.

General product characteristics

3.2 Functional range

Table 4 Functional range

Parameter	Symbol	Values			Unit	Note or Test Condition	Number
		Min.	Typ.	Max.			
Input voltage	V_I	5.5	–	40	V	–	P_3.2.1
Junction temperature	T_J	-40	–	150	°C	–	P_3.2.2

Note: Within the functional or operating range, the IC operates as described in the circuit description. The electrical characteristics are specified within the conditions given in the Electrical Characteristics table.

3.3 Thermal resistance

Table 5 Thermal resistance

Parameter	Symbol	Values			Unit	Note or Test Condition	Number
		Min.	Typ.	Max.			
PG-TO263-7 package							
Junction ambient	R_{thja}	–	–	70	K/W	–	P_3.3.4
Junction-case	R_{thjc}	–	–	6	K/W	–	P_3.3.5
Junction-case	Z_{thjc}	–	–	2	K/W	$t < 1$ ms	P_3.3.6
PG-DSO-14 package							
Junction ambient	R_{thja}	–	–	70	K/W	–	P_3.3.10
Junction-pin	R_{thjp}	–	–	30	K/W	–	P_3.3.11

Note: This thermal data was generated in accordance with JEDEC JESD51 standards. For more information, go to www.jedec.org.

Functional description

4 Functional description

Application

The IC regulates an input voltage V_I in the range of $5.5\text{ V} < V_I < 40\text{ V}$ to a nominal output voltage of $V_Q = 5.0\text{ V}$. A reset signal is generated for an output voltage of $V_Q < V_{RT}$ (typ. 4.5 V). The reset delay can be set with an external capacitor. The device has two logic inputs. A voltage of $V_{E2} > 4.0\text{ V}$ applied to the E2-pin (e.g. by ignition) turns the device on. Depending on the voltage on pin E6 the IC may be kept in Hold active-state even if V_{E2} goes to low level (see [Table 6](#)). This makes it simple to implement a self-holding circuit without external components. When the device is turned off, the output voltage drops to 0 V and current consumption tends towards 0 μA .

Design notes for external components

The input capacitor C_I is necessary for compensation of line influences. The resonant circuit consisting of lead inductance and input capacitance can be damped by a resistor of approximately $1\ \Omega$ in series with C_I . The output capacitor is necessary for the stability of the regulating circuit. Stability is specified at values of $C_Q \geq 22\ \mu\text{F}$ and an ESR of $\leq 3\ \Omega$ within the operating temperature range.

Circuit description

The control amplifier compares a reference voltage, which is kept highly accurate by resistance adjustment, to a voltage that is proportional to the output voltage and drives the base of the series transistor via a buffer. Saturation control as a function of the load current prevents any over-saturating of the power element.

The reset output RO is in high-state if the voltage on the delay capacitor C_D is greater or equal V_{UD} . The delay capacitance C_D is charged with the current I_D for output voltages greater than the reset threshold V_{RT} . If the output voltage drops below V_{RT} a fast discharge of the delay capacitor C_D sets in and as soon as V_{CD} drops below V_{LD} the reset output RO is set to low-level (see [Figure 6](#)). The reset delay can be set within a wide range by dimensioning the capacitance of the external capacitor.

Table 6 Truth table for turn-ON/turn-OFF logic

E2, Inhibit¹⁾	E6, Hold²⁾	V_Q	Remarks
L	X	OFF	Initial state
H	X	ON	Regulator switched on via Inhibit, by ignition for example
H	L	ON	Hold clamped active to ground by controller while Inhibit is still high
X	L	ON	Previous state remains, even if ignition is shutting off: self-holding state
L	L	ON	Ignition shut off while regulator is in self-holding state
L	H	OFF	Regulator shut down by releasing of Hold while Inhibit remains Low, final state. No active clamping required by external self-holding circuit (μC) to keep regulator in off-state

1) Inhibit: E2 Enable function, active high.

2) Hold: E6 Hold and release function, active low.

Functional description

4.1 Electrical characteristics

Table 7 Electrical characteristics

$V_I = 13.5 \text{ V}$; $-40^\circ\text{C} < T_J < 125^\circ\text{C}$; $V_{E2} > 4 \text{ V}$ (unless specified otherwise)

Parameter	Symbol	Values			Unit	Note or Test Condition	Number
		Min.	Typ.	Max.			
Output voltage	V_Q	4.9	5	5.1	V	$5 \text{ mA} \leq I_Q \leq 400 \text{ mA}$ $6 \text{ V} \leq V_I \leq 26 \text{ V}$	P_4.1.1
Output voltage	V_Q	4.9	5	5.1	V	$5 \text{ mA} \leq I_Q \leq 150 \text{ mA}$ $6 \text{ V} \leq V_I \leq 40 \text{ V}$	P_4.1.2
Output current limiting	I_Q	500	–	–	mA	$T_J = 25^\circ\text{C}$	P_4.1.3
Current consumption $I_q = I_I - I_Q$	I_q	–	–	50	μA	IC turned off	P_4.1.4
Current consumption $I_q = I_I - I_Q$	I_q	–	1.0	10	μA	$T_J = 25^\circ\text{C}$ IC turned off	P_4.1.5
Current consumption $I_q = I_I - I_Q$	I_q	–	1.3	4	mA	$I_Q = 5 \text{ mA}$ IC turned on	P_4.1.6
Current consumption $I_q = I_I - I_Q$	I_q	–	–	60	mA	$I_Q = 400 \text{ mA}$	P_4.1.7
Current consumption $I_q = I_I - I_Q$	I_q	–	–	80	mA	$I_Q = 400 \text{ mA}$ $V_I = 5 \text{ V}$	P_4.1.8
Drop voltage	V_{Dr}	–	0.3	0.6	V	$I_Q = 400 \text{ mA}^{1)}$	P_4.1.9
Load regulation	ΔV_Q	–	–	50	mV	$5 \text{ mA} \leq I_Q \leq 400 \text{ mA}$	P_4.1.10
Supply-voltage regulation	ΔV_Q	–	15	25	mV	$V_I = 6 \text{ to } 36 \text{ V}$; $I_Q = 5 \text{ mA}$	P_4.1.11
Supply-voltage rejection	SVR	–	54	–	dB	$f_r = 100 \text{ Hz}$; $V_r = 0.5 \text{ Vpp}$	P_4.1.12
Longterm stability	ΔV_Q	–	0	–	mV	1000 h	P_4.1.13

Reset generator

Switching threshold	V_{RT}	4.2	4.5	4.8	V	–	P_4.1.14
Reset High level	–	4.5	–	–	V	$R_{ext} = \infty$	P_4.1.15
Saturation voltage	$V_{RO,SAT}$	–	0.1	0.4	V	$R_R = 4.7 \text{ k}\Omega^{2)}$	P_4.1.16
Internal Pull-up resistor	R_{RO}	–	30	–	k Ω	–	P_4.1.17
Saturation voltage	$V_{D,SAT}$	–	50	100	mV	$V_Q < V_{RT}$	P_4.1.18
Charge current	I_D	8	15	25	μA	$V_D = 1.5 \text{ V}$	P_4.1.19
Upper delay switching threshold	V_{UD}	2.6	3	3.3	V	–	P_4.1.20
Delay time	t_D	–	20	–	ms	$C_D = 100 \text{ nF}$	P_4.1.21
Lower delay switching threshold	V_{LD}	–	0.43	–	V	–	P_4.1.22
Reset reaction time	t_{RR}	–	2	–	μs	$C_D = 100 \text{ nF}$	P_4.1.23

Inhibit

Turn on voltage	$V_{U,INH}$	–	3	4	V	IC turned on	P_4.1.24
Turn off voltage	$V_{L,INH}$	2	–	–	V	IC turned off	P_4.1.25

Functional description

Table 7 Electrical characteristics (cont'd)

$V_I = 13.5\text{ V}$; $-40^\circ\text{C} < T_J < 125^\circ\text{C}$; $V_{E2} > 4\text{ V}$ (unless specified otherwise)

Parameter	Symbol	Values			Unit	Note or Test Condition	Number
		Min.	Typ.	Max.			
Pull-down resistor	R_{INH}	50	100	200	k Ω	–	P_4.1.26
Hysteresis	ΔV_{INH}	0.2	0.5	0.8	V	–	P_4.1.27
Input current	I_{INH}	–	35	100	μA	$V_{INH} = 4\text{ V}$	P_4.1.28
Hold voltage	$V_{U,HOLD}$	30	35	40	%	Referred to V_Q	P_4.1.29
Turn off voltage	$V_{L,HOLD}$	60	70	80	%	Referred to V_Q	P_4.1.30
Pull-up resistor	R_{HOLD}	20	50	100	k Ω	–	P_4.1.31

Overvoltage Protection

Turn off voltage	$V_{I,OV}$	42	44	46	V	V_I increasing	P_4.1.32
Turn on voltage	$V_{I,turn\ on}$	36	–	–	V	V_I decreasing after turn off	P_4.1.33

- 1) Drop voltage = $V_I - V_Q$ (measured when the output voltage V_Q has dropped 100 mV from the nominal value obtained at $V_I = 13.5\text{ V}$).
- 2) The reset output is low for $1\text{ V} < V_Q < V_{RT}$.

Functional description

4.2 Typical performance characteristics

Output voltage V_Q versus junction temperature T_j

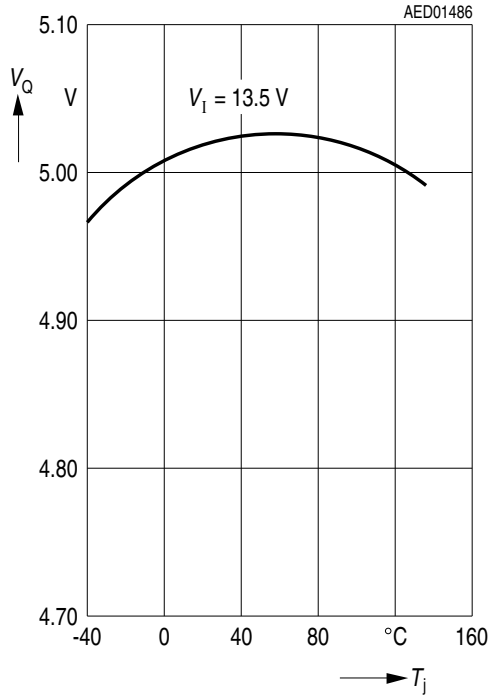

Drop voltage V_{Dr} versus output current I_Q

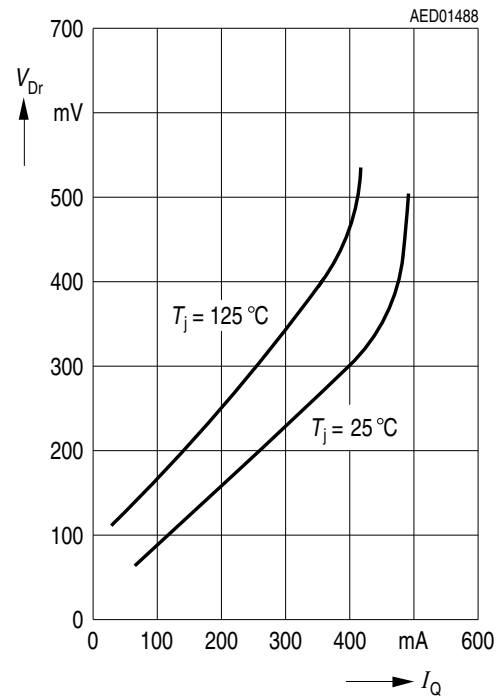

Charge current I_D versus junction temperature T_j

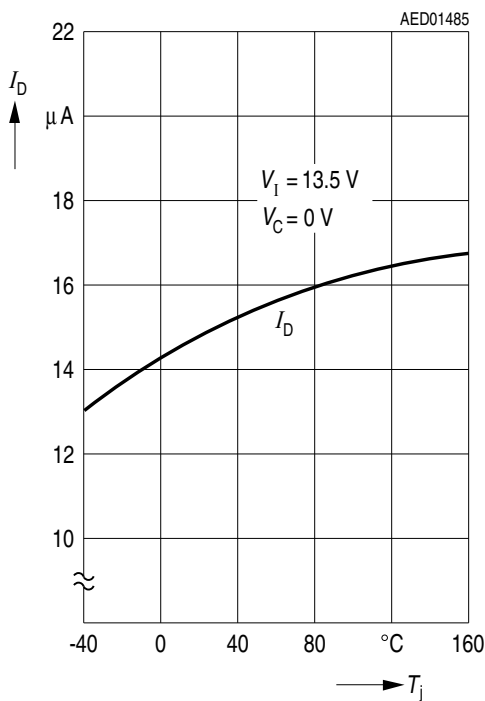

Delay switching threshold V_{UD} versus junction temperature T_j

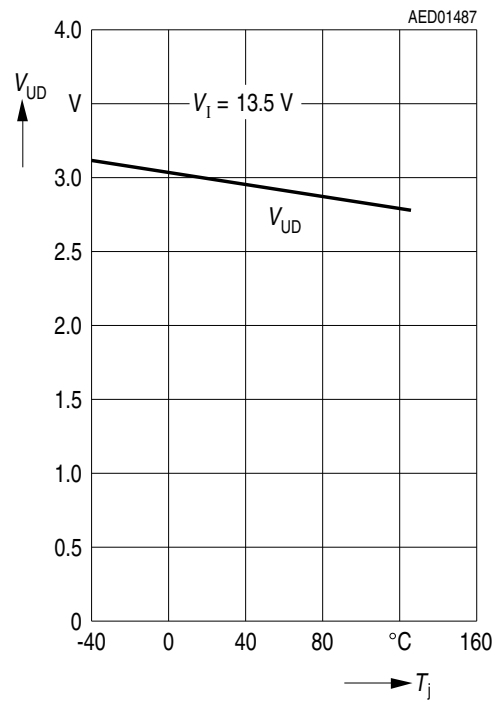

Functional description

Current consumption I_q versus output current I_Q

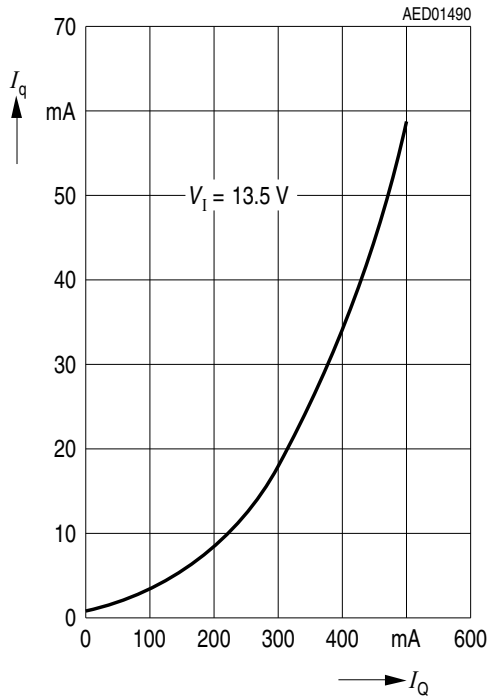

Current consumption I_q versus input voltage V_I

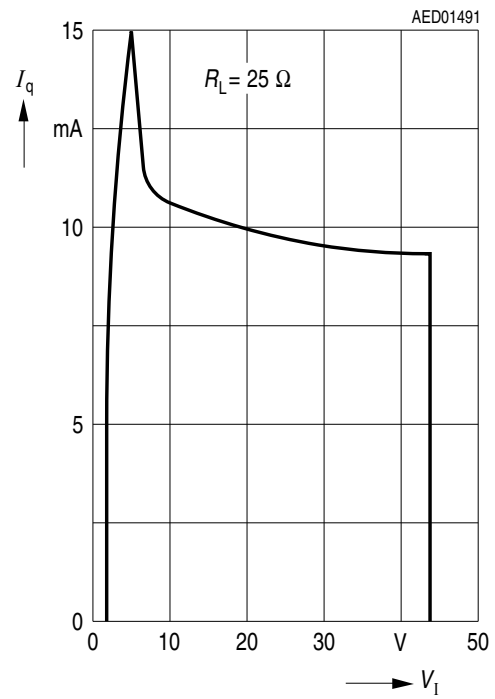

Output current limiting I_Q versus junction temperature T_j

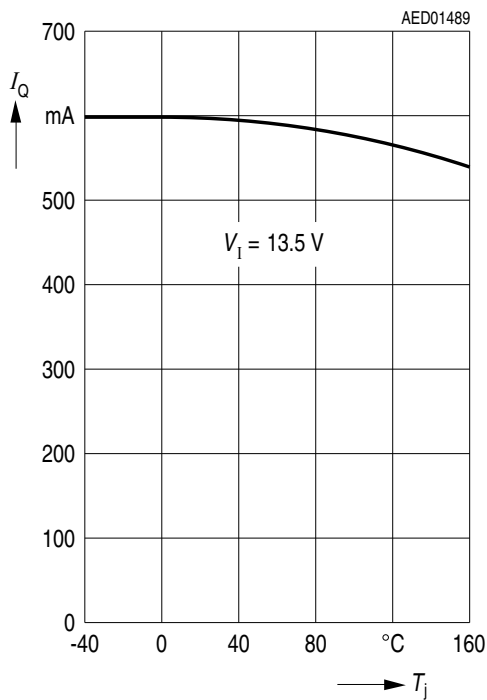

Output current limiting I_Q versus input voltage V_I

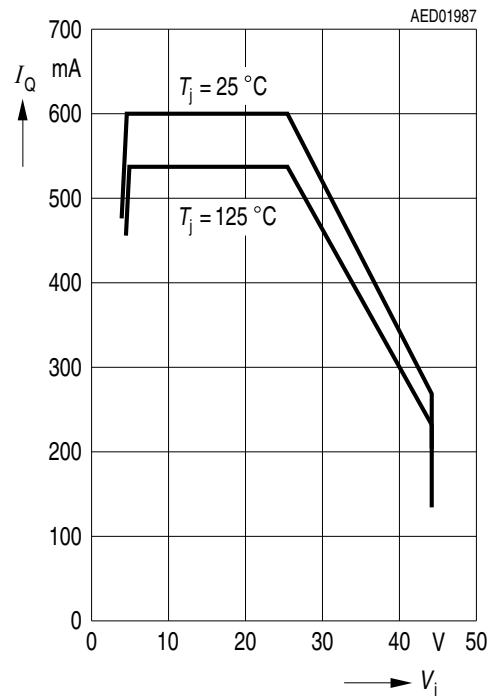

Functional description

**Output voltage V_Q versus
inhibit voltage V_{INH}**

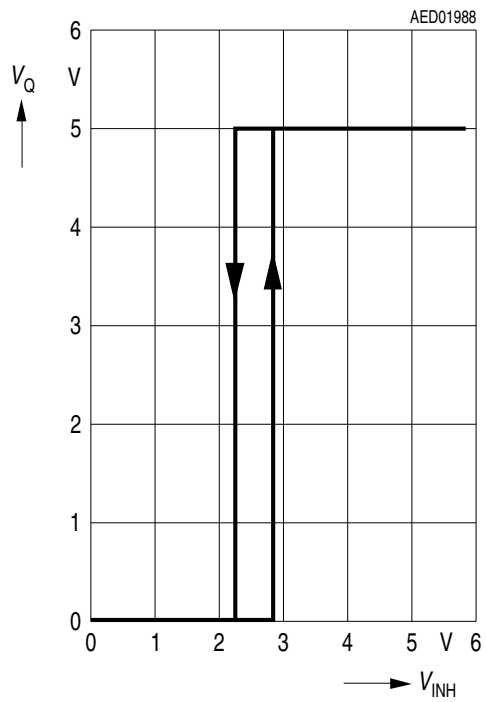

**Inhibit current I_{INH} versus
inhibit voltage V_{INH}**

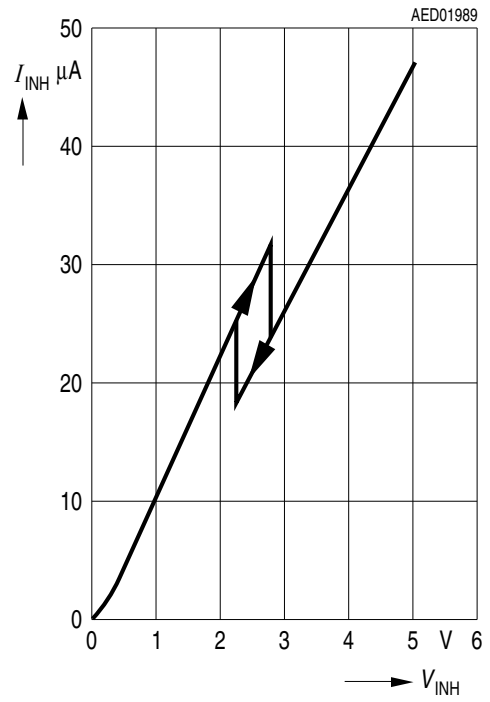

Test and application circuit

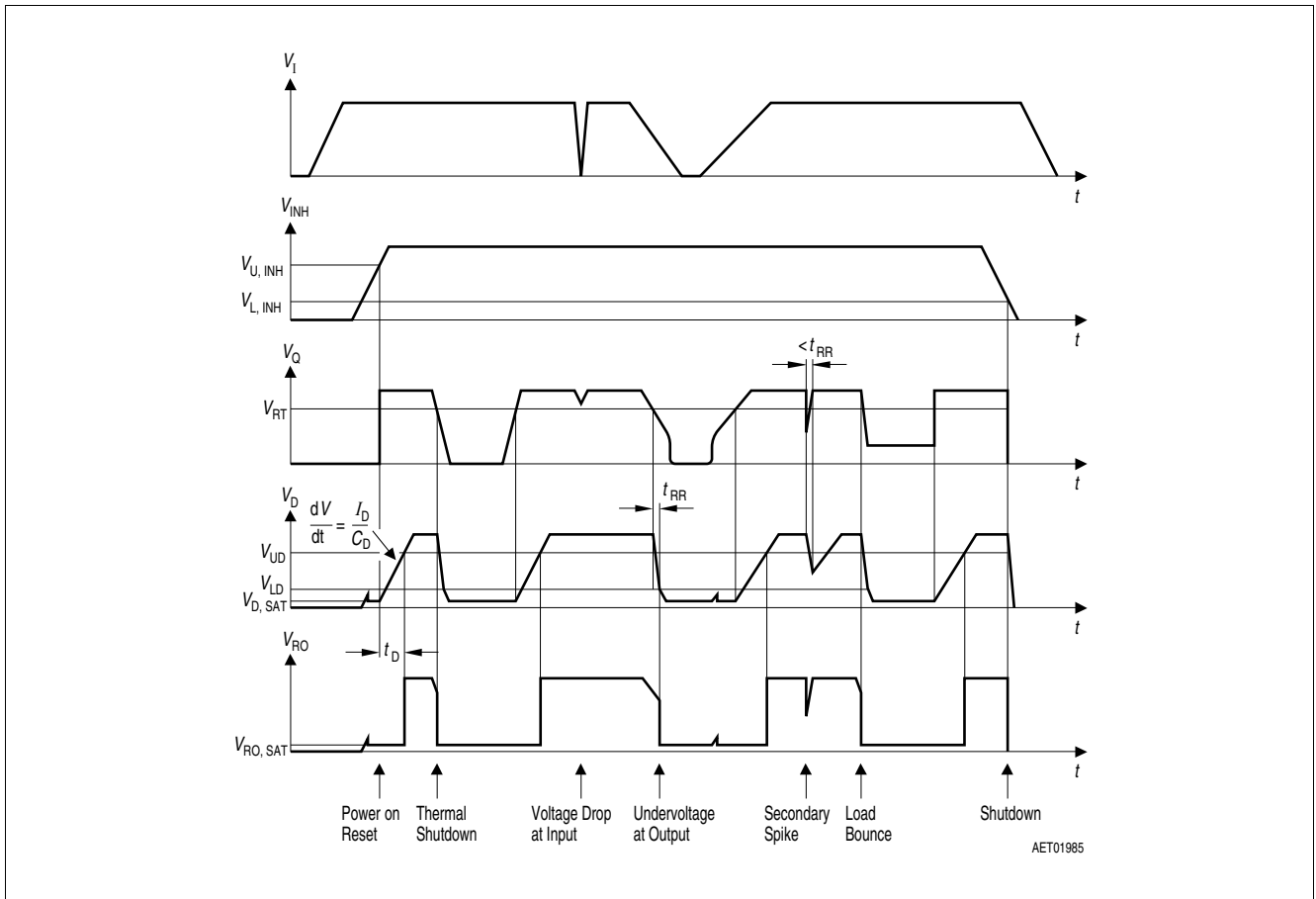

Figure 6 Time response

Test and application circuit

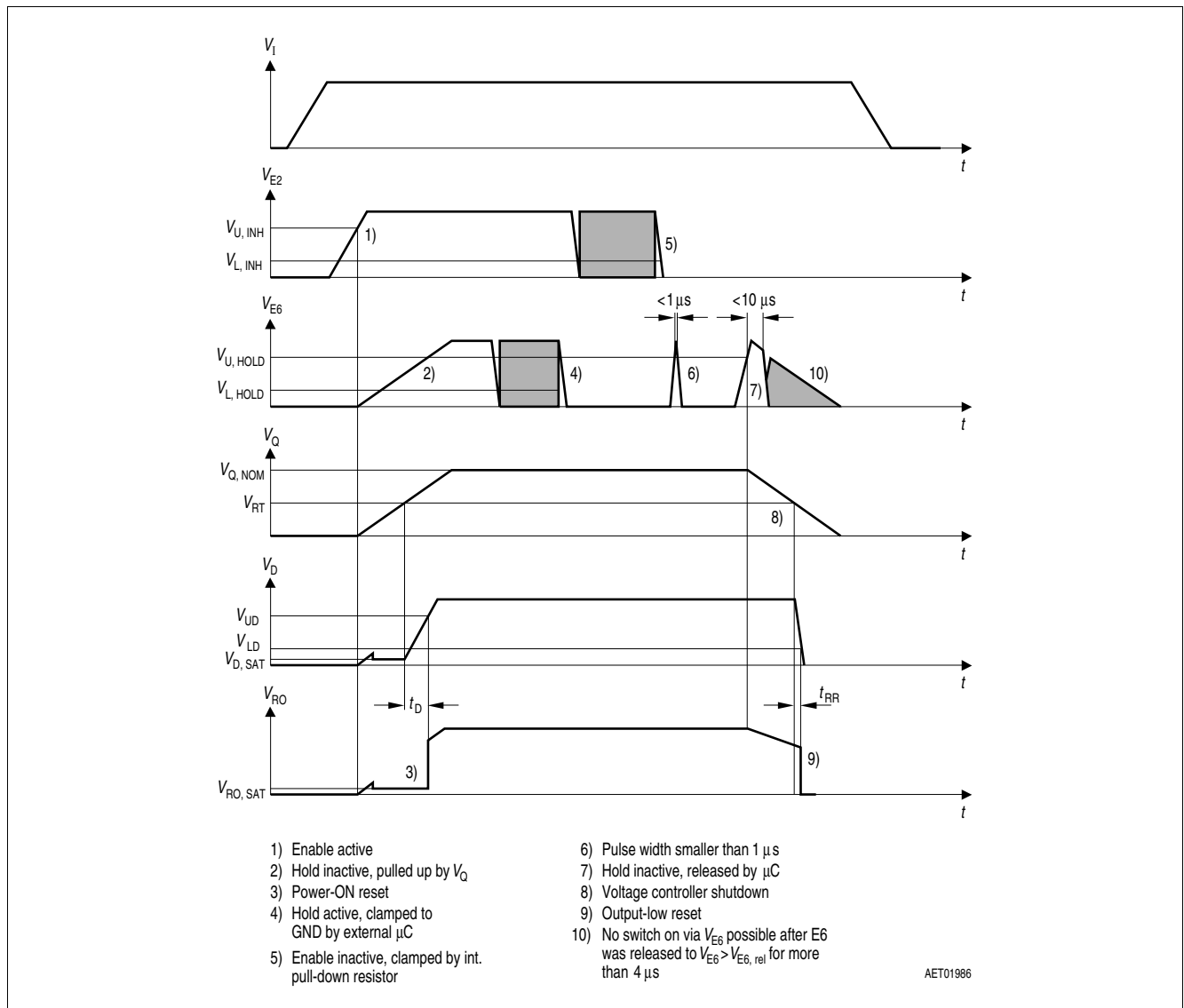

Figure 7 Enable and Hold behavior

Package outlines

6 Package outlines

Green Product (RoHS compliant)

To meet the world-wide customer requirements for environmentally friendly products and to be compliant with government regulations the device is available as a green product. Green products are RoHS-Compliant (i.e Pb-free finish on leads and suitable for Pb-free soldering according to IPC/JEDEC J-STD-020).

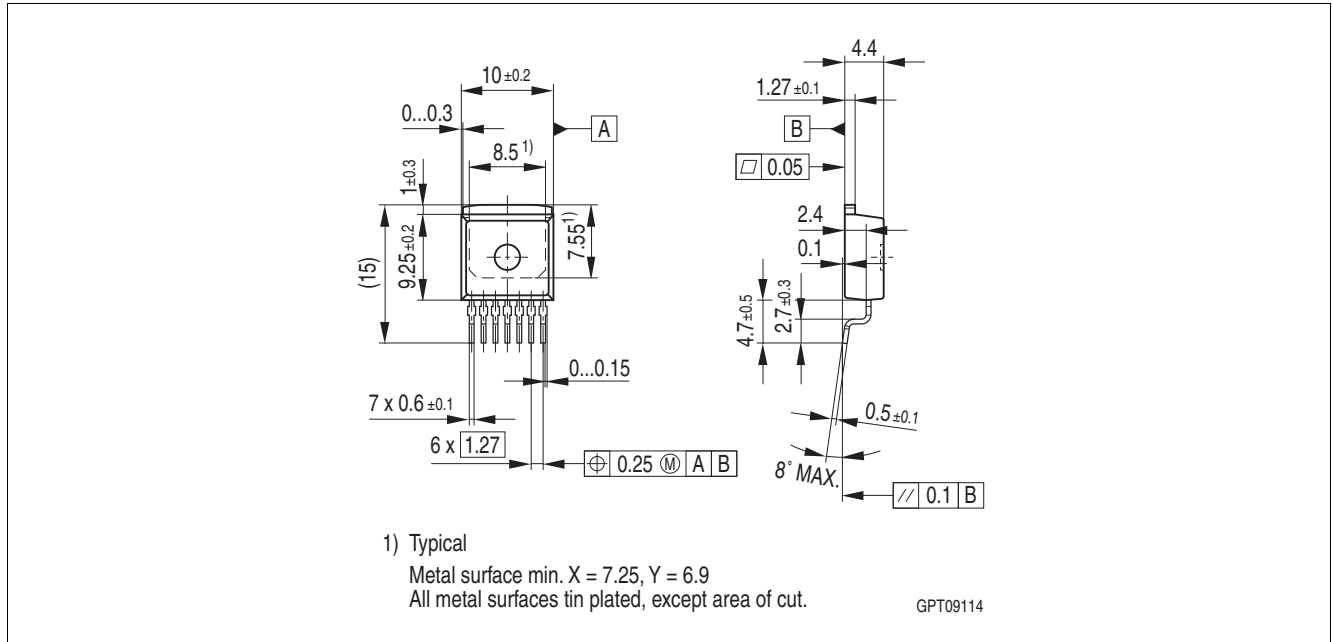

Figure 8 PG-T0263-7 (Plastic Transistor Single Outline)

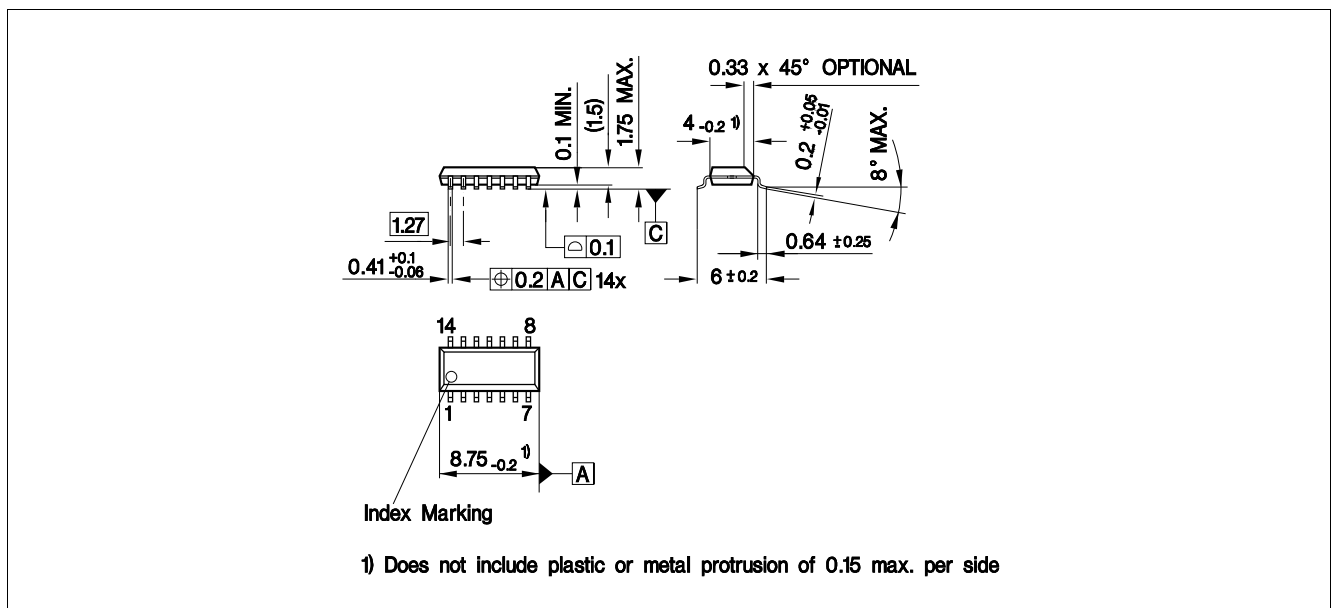

Figure 9 PG-DSO-14 (Plastic Dual Small Outline)

For further information on alternative packages, please visit our website:
<http://www.infineon.com/packages>.

Dimensions in mm

Revision history

7 Revision history

Revision	Date	Changes
2.6	2018-07-03	Discontinued product variants TLE4267 and TLE4267S removed from data sheet. Editorial changes. Package updated by optional chamfer for PG-DSO-14.
2.51	2012-02-20	Page 1: Cover page added. Page 4: Figure 1 “Block diagram TLE4267” updated with clear label for reset output pin. Page 15: Figure 5 “Application circuit TLE4267” updated with clear labels for inhibit, hold, reset and reset delay pin.
2.5	2007-03-20	Initial version of RoHS-compliant derivative of TLE4267: Page 1: AEC certified statement added. Page 1 and Page 18 ff: RoHS compliance statement and Green product feature added. Page 1 and Page 18 ff: Package changed to RoHS compliant version Legal Disclaimer updated.

Trademarks

All referenced product or service names and trademarks are the property of their respective owners.

Edition 2018-07-03

Published by

Infineon Technologies AG

81726 Munich, Germany

© 2018 Infineon Technologies AG.

All Rights Reserved.

Do you have a question about any aspect of this document?

Email: erratum@infineon.com

Document reference

Z8F50686678

IMPORTANT NOTICE

The information given in this document shall in no event be regarded as a guarantee of conditions or characteristics ("Beschaffheitsgarantie").

With respect to any examples, hints or any typical values stated herein and/or any information regarding the application of the product, Infineon Technologies hereby disclaims any and all warranties and liabilities of any kind, including without limitation warranties of non-infringement of intellectual property rights of any third party.

In addition, any information given in this document is subject to customer's compliance with its obligations stated in this document and any applicable legal requirements, norms and standards concerning customer's products and any use of the product of Infineon Technologies in customer's applications.

The data contained in this document is exclusively intended for technically trained staff. It is the responsibility of customer's technical departments to evaluate the suitability of the product for the intended application and the completeness of the product information given in this document with respect to such application.

For further information on technology, delivery terms and conditions and prices, please contact the nearest Infineon Technologies Office (www.infineon.com).

WARNINGS

Due to technical requirements products may contain dangerous substances. For information on the types in question please contact your nearest Infineon Technologies office.

Except as otherwise explicitly approved by Infineon Technologies in a written document signed by authorized representatives of Infineon Technologies, Infineon Technologies' products may not be used in any applications where a failure of the product or any consequences of the use thereof can reasonably be expected to result in personal injury.

Looking for pricing, stock, or lifecycle information?

Click below to explore more details on WIN SOURCE:

- ⊖ [View TLE4267G on WIN SOURCE](#)
- ⊖ [Infineon Technologies Information](#)

Optimize Your Supply Chain with WIN SOURCE Solutions

- ✓ Global Sourcing Solution
- ✓ Obsolete Management
- ✓ Cost Control Management
- ✓ Shortage Management
- ✓ Alternative Solution
- ✓ Excess Inventory Management