



# THE DATASHEET OF TLV2444CDR



# TLV2442, TLV2442A, TLV2444, TLV2444A Advanced LinCMOS™ RAIL-TO-RAIL OUTPUT WIDE-INPUT-VOLTAGE OPERATIONAL AMPLIFIERS

SLOS169H – NOVEMBER 1996 – REVISED MARCH 2001

- Output Swing Includes Both Supply Rails
- Extended Common-Mode Input Voltage Range . . . 0 V to 4.25 V (Min) at 5-V Single Supply
- No Phase Inversion
- Low Noise . . . 16 nV/√Hz Typ at f = 1 kHz
- Low Input Offset Voltage  
950 μV Max at T<sub>A</sub> = 25°C (TLV244xA)
- Low Input Bias Current . . . 1 pA Typ
- 600-Ω Output Drive
- High-Gain Bandwidth . . . 1.8 MHz Typ
- Low Supply Current . . . 750 μA Per Channel Typ
- Macromodel Included
- Available in Q-Temp Automotive  
HighRel Automotive Applications  
Configuration Control/Print Support  
Qualification to Automotive Standards

## description

The TLV244x and TLV244xA are low-voltage operational amplifiers from Texas Instruments. The common-mode input voltage range of these devices has been extended over typical standard CMOS amplifiers, making them suitable for a wide range of applications. In addition, these devices do not phase invert when the common-mode input is driven to the supply rails. This satisfies most design requirements without paying a premium for rail-to-rail input performance. They also exhibit rail-to-rail output performance for increased dynamic range in single- or split-supply applications. This family is fully characterized at 3-V and 5-V supplies and is optimized for low-voltage operation. Both devices offer comparable ac performance while having lower noise, input offset voltage, and power dissipation than existing CMOS operational amplifiers. The TLV244x has increased output drive over previous rail-to-rail operational amplifiers and can drive 600-Ω loads for telecommunications applications.

The other members in the TLV244x family are the low-power, TLV243x, and micro-power, TLV2422, versions.

The TLV244x, exhibiting high input impedance and low noise, is excellent for small-signal conditioning for high-impedance sources, such as piezoelectric transducers. Because of the micropower dissipation levels and low-voltage operation, these devices work well in hand-held monitoring and remote-sensing applications. In addition, the rail-to-rail output feature with single- or split-supplies makes this family a great choice when interfacing with analog-to-digital converters (ADCs). For precision applications, the TLV244xA is available with a maximum input offset voltage of 950 μV.

If the design requires single operational amplifiers, see the TI TLV2211/21/31. This is a family of rail-to-rail output operational amplifiers in the SOT-23 package. Their small size and low power consumption make them ideal for high density, battery-powered equipment.

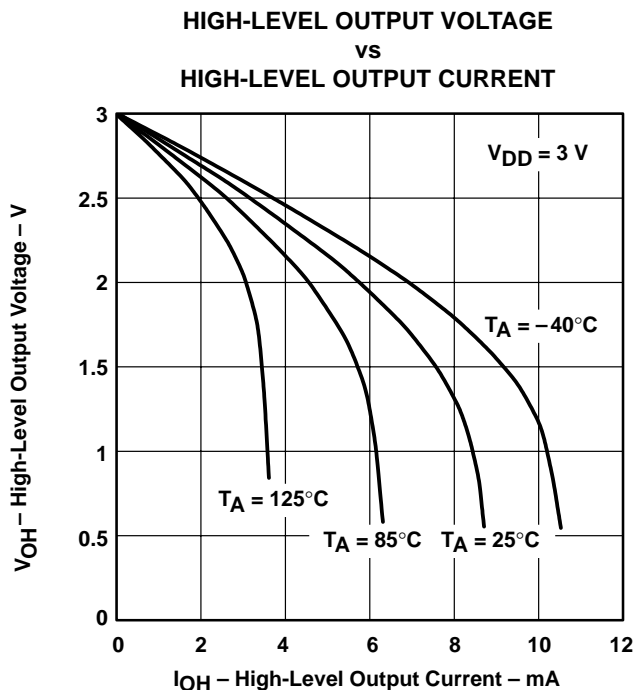

Figure 1



Please be aware that an important notice concerning availability, standard warranty, and use in critical applications of Texas Instruments semiconductor products and disclaimers thereto appears at the end of this data sheet.

Advanced LinCMOS is a trademark of Texas Instruments.

PRODUCTION DATA information is current as of publication date. Products conform to specifications per the terms of Texas Instruments standard warranty. Production processing does not necessarily include testing of all parameters.

 **TEXAS  
INSTRUMENTS**

POST OFFICE BOX 655303 • DALLAS, TEXAS 75265

Copyright © 2001, Texas Instruments Incorporated  
On products compliant to MIL-PRF-38535, all parameters are tested unless otherwise noted. On all other products, production processing does not necessarily include testing of all parameters.

# TLV2442, TLV2442A, TLV2444, TLV2444A

## Advanced LinCMOS™ RAIL-TO-RAIL OUTPUT

### WIDE-INPUT-VOLTAGE OPERATIONAL AMPLIFIERS

SLOS169H – NOVEMBER 1996 – REVISED MARCH 2001

#### TLV2442 AVAILABLE OPTIONS

T <sub>A</sub>	V <sub>IO</sub> max AT 25°C	PACKAGED DEVICES				
		SMALL OUTLINE (D)	CHIP CARRIER (FK)	CERAMIC DIP (JG)	TSSOP (PW)	CERAMIC FLAT PACK (U)
0°C to 70°C	2.5 mV	TLV2442CD	—	—	TLV2442CPW	—
–40°C to 85°C	950 μV 2.5 mV	TLV2442AID TLV2442ID	— —	— —	TLV2442AIPW —	— —
–40°C to 125°C	950 μV 2.5 mV	TLV2442AQD TLV2442QD	— —	— —	TLV2442AQPW TLV2442QPW	— —
–55°C to 125°C	950 μV 2.5 mV	— —	TLV2442AMFK TLV2442MFK	TLV2442AMJG TLV2442MJG	— —	TLV2442AMU TLV2442MU

The D and PW packages are available taped and reeled. Add R suffix to device type (e.g., TLV2442CDR).

#### TLV2444 AVAILABLE OPTIONS

T <sub>A</sub>	V <sub>IO</sub> max AT 25°C	PACKAGED DEVICES	
		SMALL OUTLINE (D)	TSSOP (PW)
0°C to 70°C	2.5 mV	TLV2444CD	TLV2444CPW
–40°C to 125°C	950 μV 2.5 mV	TLV2444AID TLV2444ID	TLV2444AIPW TLV2444IPW

The D and PW packages are available taped and reeled. Add R suffix to device type (e.g., TLV2444CDR).

**TLV2442  
D OR JG PACKAGE  
(TOP VIEW)**

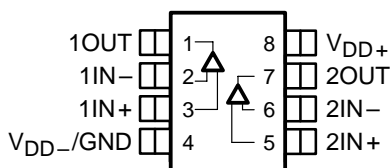

**TLV2442  
PW PACKAGE  
(TOP VIEW)**

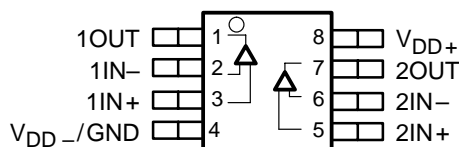

**TLV2442  
FK PACKAGE  
(TOP VIEW)**

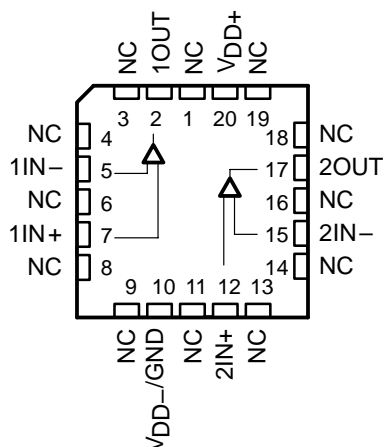

**TLV2442  
U PACKAGE  
(TOP VIEW)**

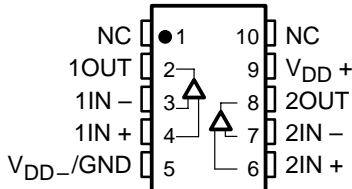

**TLV2444  
D OR PW PACKAGE  
(TOP VIEW)**

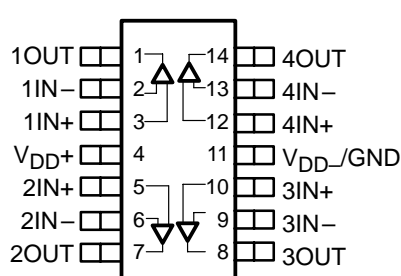

NC – No internal connection



equivalent schematic (each amplifier)



**TLV2442, TLV2442A, TLV2444, TLV2444A**  
**Advanced LinCMOS™ RAIL-TO-RAIL OUTPUT**  
**WIDE-INPUT-VOLTAGE OPERATIONAL AMPLIFIERS**

SLOS169H – NOVEMBER 1996 – REVISED MARCH 2001

**absolute maximum ratings over operating free-air temperature range (unless otherwise noted)†**

Supply voltage, $V_{DD}$ (see Note 1)	12 V
Differential input voltage, $V_{ID}$ (see Note 2)	$\pm V_{DD}$
Input voltage, $V_I$ (any input, see Note 1)	-0.3 V to $V_{DD}$
Input current, $I_I$ (any input)	$\pm 5$ mA
Output current, $I_O$	$\pm 50$ mA
Total current into $V_{DD+}$	$\pm 50$ mA
Total current out of $V_{DD-}$	$\pm 50$ mA
Duration of short-circuit current at (or below) 25°C (see Note 3)	unlimited
Continuous total dissipation	See Dissipation Rating Table
Operating free-air temperature range, $T_A$ : C suffix	0°C to 70°C
I suffix (dual)	-40°C to 85°C
I suffix (quad)	-40°C to 125°C
Q suffix	-40°C to 125°C
M suffix	-55°C to 125°C
Storage temperature range, $T_{stg}$	-65°C to 150°C
Lead temperature 1,6 mm (1/16 inch) from case for 10 seconds	260°C

† Stresses beyond those listed under “absolute maximum ratings” may cause permanent damage to the device. These are stress ratings only, and functional operation of the device at these or any other conditions beyond those indicated under “recommended operating conditions” is not implied. Exposure to absolute-maximum-rated conditions for extended periods may affect device reliability.

- NOTES: 1. All voltage values, except differential voltages, are with respect to the midpoint between  $V_{DD+}$  and  $V_{DD-}$ .  
 2. Differential voltages are at  $IN+$  with respect to  $IN-$ . Excessive current will flow if input is brought below  $V_{DD-} - 0.3$  V.  
 3. The output may be shorted to either supply. Temperature and/or supply voltages must be limited to ensure that the maximum dissipation rating is not exceeded.

**DISSIPATION RATING TABLE**

PACKAGE	$T_A \leq 25^\circ\text{C}$ POWER RATING	DERATING FACTOR ABOVE $T_A = 25^\circ\text{C}$	$T_A = 70^\circ\text{C}$ POWER RATING	$T_A = 85^\circ\text{C}$ POWER RATING	$T_A = 125^\circ\text{C}$ POWER RATING
D (8)	725 mW	5.8 mW/°C	464 mW	377 mW	145 mW
D (14)	1022 mW	7.6 mW/°C	900 mW	777 mW	450 mW
FK	1375 mW	11.0 mW/°C	880 mW	715 mW	275 mW
JG	1050 mW	8.4 mW/°C	672 mW	546 mW	210 mW
PW (8)	525 mW	4.2 mW/°C	336 mW	273 mW	105 mW
PW (14)	720 mW	5.6 mW/°C	634 mW	547 mW	317 mW
U	675 mW	5.4 mW/°C	432 mW	350 mW	135 mW

**recommended operating conditions**

	C SUFFIX		I SUFFIX		Q SUFFIX		M SUFFIX		UNIT
	MIN	MAX	MIN	MAX	MIN	MAX	MIN	MAX	
Supply voltage, $V_{DD}$	2.7	10	2.7	10	2.7	10	2.7	10	V
Input voltage range, $V_I$	$V_{DD-}$	$V_{DD+} - 1$	$V_{DD-}$	$V_{DD+} - 1$	$V_{DD-}$	$V_{DD+} - 1.3$	$V_{DD-}$	$V_{DD+} - 1.3$	V
Common-mode input voltage, $V_{IC}$	$V_{DD-}$	$V_{DD+} - 1$	$V_{DD-}$	$V_{DD+} - 1$	$V_{DD-} + 2$	$V_{DD+} - 1.3$	$V_{DD-} + 2$	$V_{DD+} - 1.3$	V
Operating free-air temperature, $T_A$	0	70	-40	125	-40	125	-55	125	°C



**TLV2442, TLV2442A, TLV2444, TLV2444A**  
**Advanced LinCMOS™ RAIL-TO-RAIL OUTPUT**  
**WIDE-INPUT-VOLTAGE OPERATIONAL AMPLIFIERS**

SLOS169H – NOVEMBER 1996 – REVISED MARCH 2001

**electrical characteristics at specified free-air temperature,  $V_{DD} = 3\text{ V}$  (unless otherwise noted)**

PARAMETER	TEST CONDITIONS	$T_A$ †	TLV2442			UNIT
			MIN	TYP	MAX	
$V_{IO}$ Input offset voltage	$V_{IC} = 1.5\text{ V}$ , $V_O = 1.5\text{ V}$ , $R_S = 50\ \Omega$	TLV244xC TLV244xI	25°C	300	2000	$\mu\text{V}$
			Full range	2500		
		TLV244xAI	25°C	300	950	
			Full range	1500		
		TLV2442AQ TLV2442AM	25°C	300	950	
			Full range	1600		
$\alpha_{VIO}$ Temperature coefficient of input offset voltage		25°C to 85°C	2		$\mu\text{V}/^\circ\text{C}$	
Input offset voltage long-term drift (see Note 4)		25°C	0.002		$\mu\text{V}/\text{mo}$	
$I_{IO}$ Input offset current		25°C	0.5	60	$\text{pA}$	
		Full range	150			
$I_{IB}$ Input bias current		25°C	1	60	$\text{pA}$	
		-40°C to 85°C	150			
		125°C	350			
		TLV2442Q/AQ TLV2442M/AM	Full range	260		
$V_{ICR}$ Common-mode input voltage range	$ V_{IO}  \leq 5\text{ mV}$ , $R_S = 50\ \Omega$	25°C	0 to 2.25	-0.25 to 2.5	$\text{V}$	
		Full range	0 to 2			
		25°C to -55°C	0 to 2.25	-0.25 to 2.5		
		125°C	0 to 2			
$V_{OH}$ High-level output voltage	$I_O = -100\ \mu\text{A}$	25°C	2.98		$\text{V}$	
		25°C	2.5			
		Full range	2.25			
$V_{OL}$ Low-level output voltage	$V_{IC} = 1.5\text{ V}$ , $I_O = 100\ \mu\text{A}$	25°C	0.02		$\text{V}$	
		25°C	0.63			
		Full range	1			
$A_{VD}$ Large-signal differential voltage amplification	$V_O = 1\text{ V to }2\text{ V}$	$R_L = 600\ \Omega$	25°C	0.7	1	$\text{V/mV}$
			Full range	0.4		
		$R_L = 1\ \text{M}\Omega$	25°C	750		
$r_{id}$ Differential input resistance		25°C	1000		$\text{G}\Omega$	
$r_i$ Common-mode input resistance		25°C	1000		$\text{G}\Omega$	
$c_i$ Common-mode input capacitance	$f = 10\ \text{kHz}$	25°C	8		$\text{pF}$	
$z_o$ Closed-loop output impedance	$f = 1\ \text{MHz}$ , $A_V = 10$	25°C	130		$\Omega$	

† Full range for the C suffix is 0°C to 70°C. Full range for the dual I suffix is -40°C to 85°C. Full range for the quad I suffix is -40°C to 125°C. Full range for the Q suffix is -40°C to 125°C. Full range for the M suffix is -55°C to 125°C.

NOTE 4: Typical values are based on the input offset voltage shift observed through 168 hours of operating life test at  $T_A = 150^\circ\text{C}$  extrapolated to  $T_A = 25^\circ\text{C}$  using the Arrhenius equation and assuming an activation energy of 0.96 eV.



**TLV2442, TLV2442A, TLV2444, TLV2444A**  
**Advanced LinCMOS™ RAIL-TO-RAIL OUTPUT**  
**WIDE-INPUT-VOLTAGE OPERATIONAL AMPLIFIERS**

SLOS169H – NOVEMBER 1996 – REVISED MARCH 2001

**electrical characteristics at specified free-air temperature,  $V_{DD} = 3\text{ V}$  (unless otherwise noted) (continued)**

PARAMETER	TEST CONDITIONS	$T_A$ †	TLV2442			UNIT
			MIN	TYP	MAX	
CMRR Common-mode rejection ratio	$V_{IC} = 0\text{ to }2.25\text{ V}$ , $V_O = 1.5\text{ V}$ , $R_S = 50\ \Omega$	25°C	65	75		dB
		Full range	55			
		TLV2442Q/AQ TLV2442M/AM	Full range	50		
$k_{SVR}$ Supply-voltage rejection ratio ( $\Delta V_{DD\pm}/\Delta V_{IO}$ )	$V_{DD} = 2.7\text{ V to }8\text{ V}$ , No load $V_{IC} = V_{DD}/2$ ,	25°C	80	95		dB
		Full range	80			
$I_{DD}$ Supply current (per channel)	$V_O = 1.5\text{ V}$ , No load	25°C		725	1100	$\mu\text{A}$
		Full range			1100	

† Full range for the C suffix is 0°C to 70°C. Full range for the dual I suffix is –40°C to 85°C. Full range for the quad I suffix is –40°C to 125°C. Full range for the Q suffix is –40°C to 125°C. Full range for the M suffix is –55°C to 125°C.

**operating characteristics at specified free-air temperature,  $V_{DD} = 3\text{ V}$**

PARAMETER	TEST CONDITIONS	$T_A$ †	TLV244x			UNIT
			MIN	TYP	MAX	
SR Slew rate at unity gain	$V_O = 1\text{ V to }2\text{ V}$ , $R_L = 600\ \Omega$ , $C_L = 100\text{ pF}$	25°C	0.65	1.3		$\text{V}/\mu\text{s}$
		Full range	0.65			
		TLV2442Q/AQ TLV2442M/AM	Full range	0.4		
$V_n$ Equivalent input noise voltage	$f = 10\text{ Hz}$	25°C		170		$\text{nV}/\sqrt{\text{Hz}}$
	$f = 1\text{ kHz}$	25°C		18		
$V_{N(PP)}$ Peak-to-peak equivalent input noise voltage	$f = 0.1\text{ Hz to }1\text{ Hz}$	25°C		2.6		$\mu\text{V}$
	$f = 0.1\text{ Hz to }10\text{ Hz}$	25°C		5.1		
$I_n$ Equivalent input noise current		25°C		0.6		$\text{fA}/\sqrt{\text{Hz}}$
THD + N Total harmonic distortion plus noise	$V_O = 0.5\text{ V to }2.5\text{ V}$ , $R_L = 600\ \Omega$ , $f = 1\text{ kHz}$	25°C	$A_V = 1$	0.08%		
			$A_V = 10$	0.3%		
			$A_V = 100$	2%		
Gain-bandwidth product	$f = 10\text{ kHz}$ , $C_L = 100\text{ pF}$	$R_L = 600\ \Omega$ , 25°C		1.75		MHz
BOM Maximum output-swing bandwidth	$V_{O(PP)} = 1\text{ V}$ , $A_V = 1$ ,	$R_L = 600\ \Omega$ , $C_L = 100\text{ pF}$ , 25°C		0.9		MHz
$t_s$ Settling time	$A_V = -1$ , Step = –2.3 V to 2.3 V, $R_L = 600\ \Omega$ , $C_L = 100\text{ pF}$	25°C	To 0.1%	1.5		$\mu\text{s}$
			To 0.01%	3.2		
$\phi_m$ Phase margin at unity gain	$R_L = 600\ \Omega$ , $C_L = 100\text{ pF}$	25°C		65°		
Gain margin		25°C		9		dB

† Full range for the C suffix is 0°C to 70°C. Full range for the dual I suffix is –40°C to 85°C. Full range for the quad I suffix is –40°C to 125°C. Full range for the Q suffix is –40°C to 125°C. Full range for the M suffix is –55°C to 125°C.



**TLV2442, TLV2442A, TLV2444, TLV2444A**  
**Advanced LinCMOS™ RAIL-TO-RAIL OUTPUT**  
**WIDE-INPUT-VOLTAGE OPERATIONAL AMPLIFIERS**

SLOS169H – NOVEMBER 1996 – REVISED MARCH 2001

**electrical characteristics at specified free-air temperature,  $V_{DD} = 5\text{ V}$  (unless otherwise noted)**

PARAMETER	TEST CONDITIONS	$T_A$ †	TLV244x			UNIT
			MIN	TYP	MAX	
$V_{IO}$ Input offset voltage	$V_{DD\pm} = \pm 2.5\text{ V}$ , $V_O = 0$ , $V_{IC} = 0$ , $R_S = 50\ \Omega$	TLV244xC TLV244xI	25°C	300	2000	$\mu\text{V}$
			Full range		2500	
		TLV244xA	25°C	300	950	
			Full range		1500	
		TLV2442AQ TLV2442AM	25°C	300	950	
			Full range		1600	
$\alpha_{VIO}$ Temperature coefficient of input offset voltage		25°C to 85°C	2		$\mu\text{V}/^\circ\text{C}$	
Input offset voltage long-term drift (see Note 4)		25°C	0.002		$\mu\text{V}/\text{mo}$	
$I_{IO}$ Input offset current		25°C	0.5	60	$\text{pA}$	
		Full range		150		
$I_{IB}$ Input bias current		25°C	1	60	$\text{pA}$	
		-40°C to 85°C		150		
		125°C		350		
		TLV2442Q/AQ TLV2442M/AM	Full range			260
$V_{ICR}$ Common-mode input voltage range	$ V_{IO}  \leq 5\text{ mV}$ , $R_S = 50\ \Omega$	25°C	0 to 4.25	-0.25 to 4.5	V	
		Full range	0 to 4			
$V_{OH}$ High-level output voltage	$I_{OH} = -100\ \mu\text{A}$	25°C	4.97		V	
	$I_{OH} = -5\text{ mA}$	25°C	4	4.35		
		Full range	4			
$V_{OL}$ Low-level output voltage	$V_{IC} = 2.5\text{ V}$ , $I_{OL} = 100\ \mu\text{A}$	25°C	0.01		V	
	$V_{IC} = 2.5\text{ V}$ , $I_{OL} = 5\text{ mA}$	25°C	0.8			
		Full range	1.25			
$A_{VD}$ Large-signal differential voltage amplification	$V_{IC} = 2.5\text{ V}$ , $V_O = 1\text{ V to }4\text{ V}$	$R_L = 600\ \Omega$ ‡	25°C	0.9	1.3	V/mV
			Full range	0.5		
		$R_L = 1\text{ M}\Omega$ ‡	25°C	950		
$r_{id}$ Differential input resistance		25°C	1000		$\text{G}\Omega$	
$r_i$ Common-mode input resistance		25°C	1000		$\text{G}\Omega$	
$c_i$ Common-mode input capacitance	$f = 10\text{ kHz}$	25°C	8		$\text{pF}$	
$z_o$ Closed-loop output impedance	$f = 1\text{ MHz}$ , $A_V = 10$	25°C	140		$\Omega$	
CMRR Common-mode rejection ratio	$V_{IC} = 0\text{ to }4.25\text{ V}$ , $V_O = 2.5\text{ V}$ , $R_S = 50\ \Omega$	25°C	70	75	dB	
		Full range	70			

† Full range for the C suffix is 0°C to 70°C. Full range for the dual I suffix is -40°C to 85°C. Full range for the quad I suffix is -40°C to 125°C. Full range for the Q suffix is -40°C to 125°C. Full range for the M suffix is -55°C to 125°C.

‡ Referenced to 2.5 V

NOTE 4: Typical values are based on the input offset voltage shift observed through 168 hours of operating life test at  $T_A = 150^\circ\text{C}$  extrapolated to  $T_A = 25^\circ\text{C}$  using the Arrhenius equation and assuming an activation energy of 0.96 eV.

**TLV2442, TLV2442A, TLV2444, TLV2444A**  
**Advanced LinCMOS™ RAIL-TO-RAIL OUTPUT**  
**WIDE-INPUT-VOLTAGE OPERATIONAL AMPLIFIERS**

SLOS169H – NOVEMBER 1996 – REVISED MARCH 2001

**electrical characteristics at specified free-air temperature,  $V_{DD} = 5\text{ V}$  (unless otherwise noted) (continued)**

PARAMETER	TEST CONDITIONS	$T_A$ †	TLV244x			UNIT
			MIN	TYP	MAX	
$k_{SVR}$ Supply-voltage rejection ratio ( $\Delta V_{DD}/\Delta V_{IO}$ )	$V_{DD} = 4.4\text{ V to }8\text{ V}$ , $V_{IC} = V_{DD}/2$ , No load	25°C	80	95		dB
		Full range	80			
$I_{DD}$ Supply current (per channel)	$V_O = 2.5\text{ V}$ , No load	25°C	750	1100		$\mu\text{A}$
		Full range	1100			

† Full range for the C suffix is 0°C to 70°C. Full range for the dual I suffix is –40°C to 85°C. Full range for the quad I suffix is –40°C to 125°C. Full range for the Q suffix is –40°C to 125°C. Full range for the M suffix is –55°C to 125°C.

**operating characteristics at specified free-air temperature,  $V_{DD} = 5\text{ V}$**

PARAMETER	TEST CONDITIONS	$T_A$ †	TLV244x			UNIT
			MIN	TYP	MAX	
SR Slew rate at unity gain	$V_O = 0.5\text{ V to }2.5\text{ V}$ , $R_L = 600\ \Omega$ ‡, $C_L = 100\text{ pF}$ ‡	25°C	0.75	1.4		$\text{V}/\mu\text{s}$
		Full range	0.75			
		Full range	0.5			
$V_n$ Equivalent input noise voltage	$f = 10\text{ Hz}$	25°C	130			$\text{nV}/\sqrt{\text{Hz}}$
		25°C	16			
$V_{N(PP)}$ Peak-to-peak equivalent input noise voltage	$f = 0.1\text{ Hz to }1\text{ Hz}$	25°C	1.8			$\mu\text{V}$
	$f = 0.1\text{ Hz to }10\text{ Hz}$	25°C	3.6			
$I_n$ Equivalent input noise current		25°C	0.6			$\text{fA}/\sqrt{\text{Hz}}$
THD + N Total harmonic distortion plus noise	$V_O = 1.5\text{ V to }3.5\text{ V}$ , $f = 1\text{ kHz}$ , $R_L = 600\ \Omega$ ‡	25°C	$A_V = 1$	0.017%		
			$A_V = 10$	0.17%		
			$A_V = 100$	1.5%		
Gain-bandwidth product	$f = 10\text{ kHz}$ , $R_L = 600\ \Omega$ ‡, $C_L = 100\text{ pF}$ ‡	25°C	1.81			MHz
BOM Maximum output-swing bandwidth	$V_{O(PP)} = 2\text{ V}$ , $A_V = 1$ , $R_L = 600\ \Omega$ ‡, $C_L = 100\text{ pF}$ ‡	25°C	0.5			MHz
$t_s$ Settling time	$A_V = -1$ , Step = 0.5 V to 2.5 V, $R_L = 600\ \Omega$ ‡, $C_L = 100\text{ pF}$ ‡	25°C	To 0.1%	1.5		$\mu\text{s}$
			To 0.01%	2.6		
$\phi_m$ Phase margin at unity gain	$R_L = 600\ \Omega$ ‡, $C_L = 100\text{ pF}$ ‡	25°C	68°			
Gain margin		25°C	8			dB

† Full range for the C suffix is 0°C to 70°C. Full range for the dual I suffix is –40°C to 85°C. Full range for the quad I suffix is –40°C to 125°C. Full range for the Q suffix is –40°C to 125°C. Full range for the M suffix is –55°C to 125°C.

‡ Referenced to 2.5 V



**TLV2442, TLV2442A, TLV2444, TLV2444A**  
**Advanced LinCMOS™ RAIL-TO-RAIL OUTPUT**  
**WIDE-INPUT-VOLTAGE OPERATIONAL AMPLIFIERS**

SLOS169H – NOVEMBER 1996 – REVISED MARCH 2001

**TYPICAL CHARACTERISTICS**

**Table of Graphs†**

			FIGURE
$V_{IO}$	Input offset voltage	Distribution vs Common-mode input voltage	2, 3 4, 5
$\alpha V_{IO}$	Input offset voltage temperature coefficient	Distribution	6, 7
$I_{IB}/I_{IO}$	Input bias and input offset currents	vs Free-air temperature	8
$V_{OH}$	High-level output voltage	vs High-level output current	9, 10
$V_{OL}$	Low-level output voltage	vs Low-level output current	11, 12
$V_{O(PP)}$	Maximum peak-to-peak output voltage	vs Frequency	13
$I_{OS}$	Short-circuit output current	vs Supply voltage vs Free-air temperature	14 15
$V_O$	Output voltage	vs Differential Input voltage	16, 17
$A_{VD}$	Differential voltage amplification	vs Load resistance	18
$A_{VD}$	Large-signal differential voltage amplification and phase margin	vs Frequency	19, 20
	Large-signal differential voltage amplification	vs Free-air temperature	21, 22
$z_o$	Output impedance	vs Frequency	23, 24
CMRR	Common-mode rejection ratio	vs Frequency	25
		vs Free-air temperature	26
$k_{SVR}$	Supply-voltage rejection ratio	vs Frequency	27, 28
		vs Free-air temperature	29
$I_{DD}$	Supply current	vs Supply voltage	30
SR	Slew rate	vs Load capacitance	31
		vs Free-air temperature	32
$V_O$	Inverting large-signal pulse response		33, 34
	Voltage-follower large-signal pulse response		35, 36
	Inverting small-signal pulse response		37, 38
	Voltage-follower small-signal pulse response		39, 40
$V_n$	Equivalent input noise voltage	vs Frequency	41, 42
	Noise voltage	Over a 10-second period	43
THD + N	Total harmonic distortion plus noise	vs Frequency	44, 45
	Gain-bandwidth product	vs Free-air temperature	46
		vs Supply voltage	47
$\phi_m$	Phase margin	vs Frequency	19, 20
		vs Load capacitance	48
	Gain margin	vs Load capacitance	49
$B_1$	Unity-gain bandwidth	vs Load capacitance	50

† For all graphs where  $V_{DD} = 5$  V, all loads are referenced to 2.5 V.

**TLV2442, TLV2442A, TLV2444, TLV2444A**  
**Advanced LinCMOS™ RAIL-TO-RAIL OUTPUT**  
**WIDE-INPUT-VOLTAGE OPERATIONAL AMPLIFIERS**

SLOS169H – NOVEMBER 1996 – REVISED MARCH 2001

**TYPICAL CHARACTERISTICS**

**DISTRIBUTION OF TLV2442  
 INPUT OFFSET VOLTAGE**

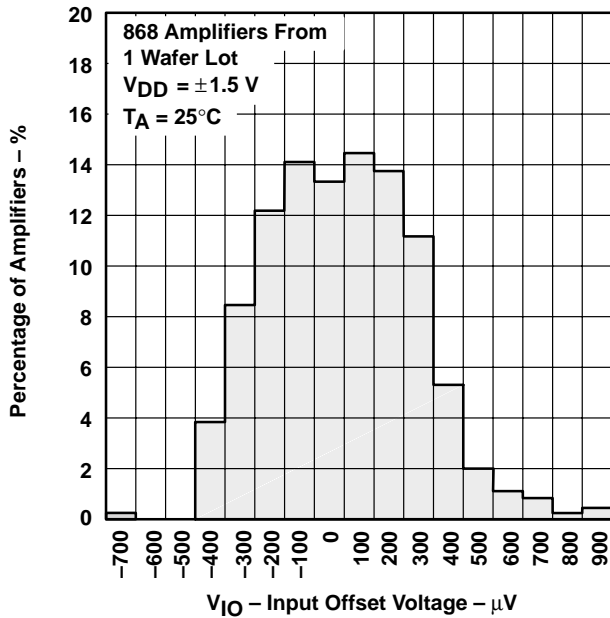

**Figure 2**

**DISTRIBUTION OF TLV2442  
 INPUT OFFSET VOLTAGE**

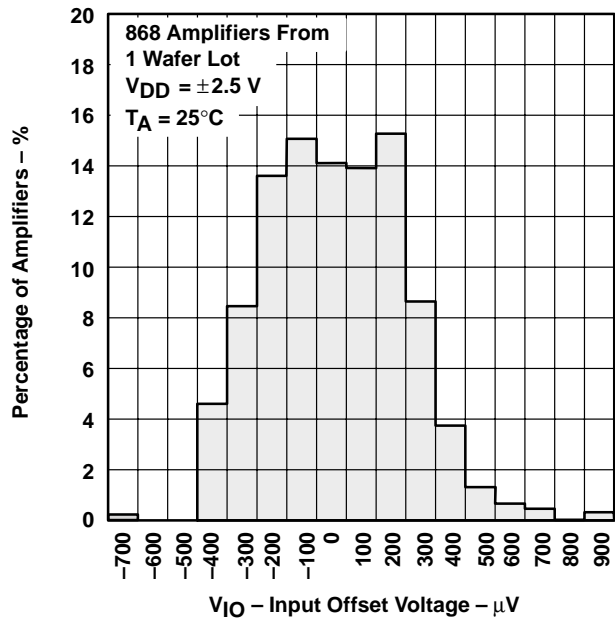

**Figure 3**

**INPUT OFFSET VOLTAGE  
 vs  
 COMMON-MODE INPUT VOLTAGE**

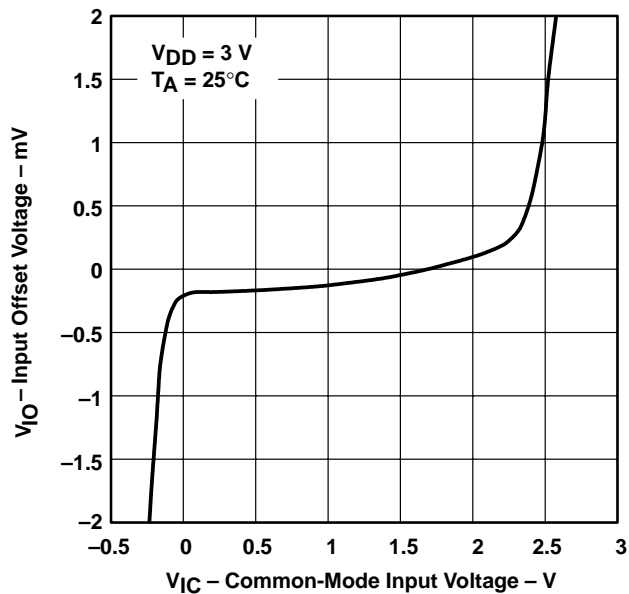

**Figure 4**

**INPUT OFFSET VOLTAGE  
 vs  
 COMMON-MODE INPUT VOLTAGE**

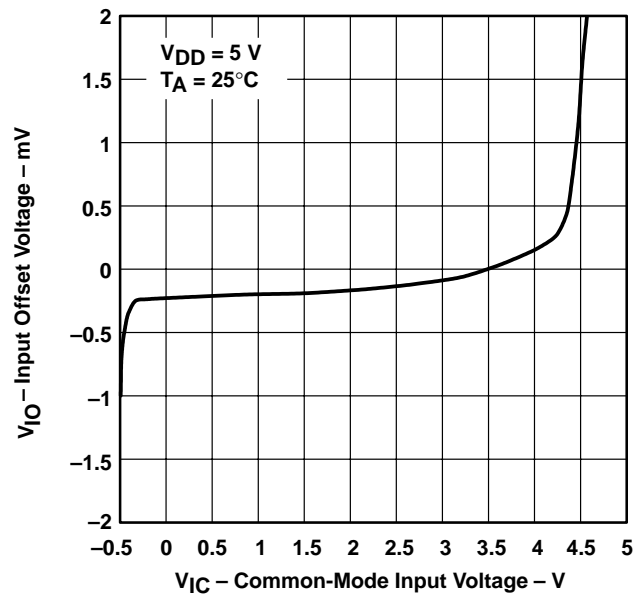

**Figure 5**



TYPICAL CHARACTERISTICS

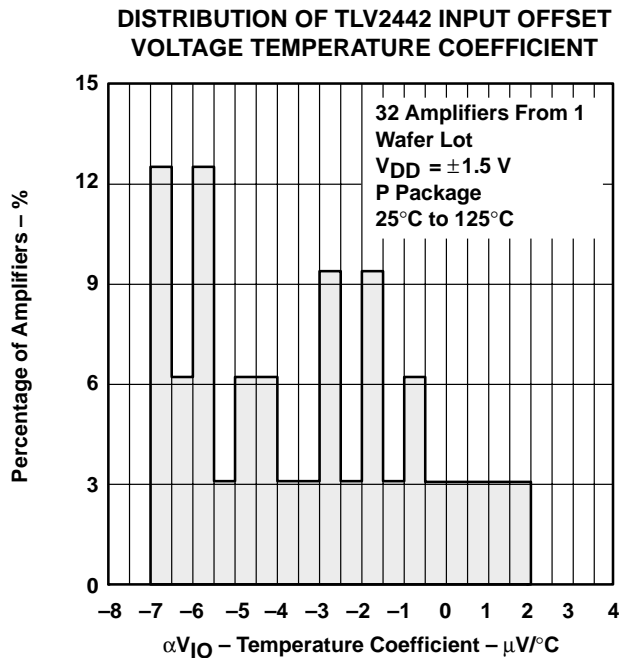

Figure 6

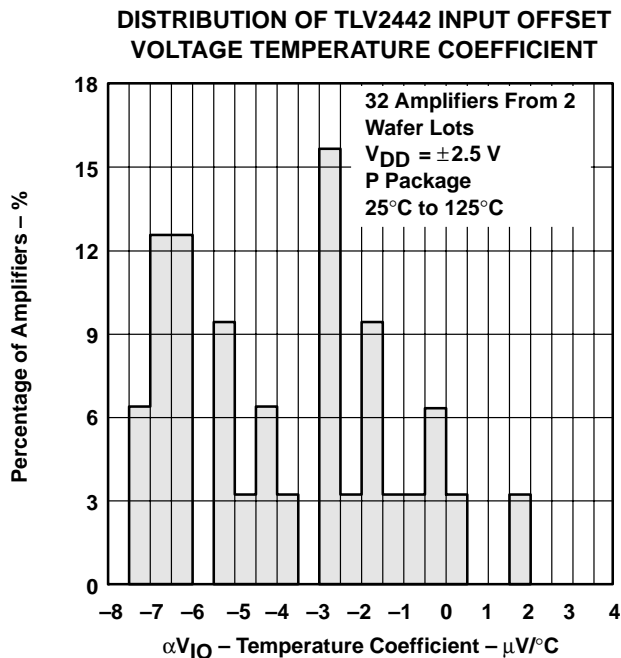

Figure 7

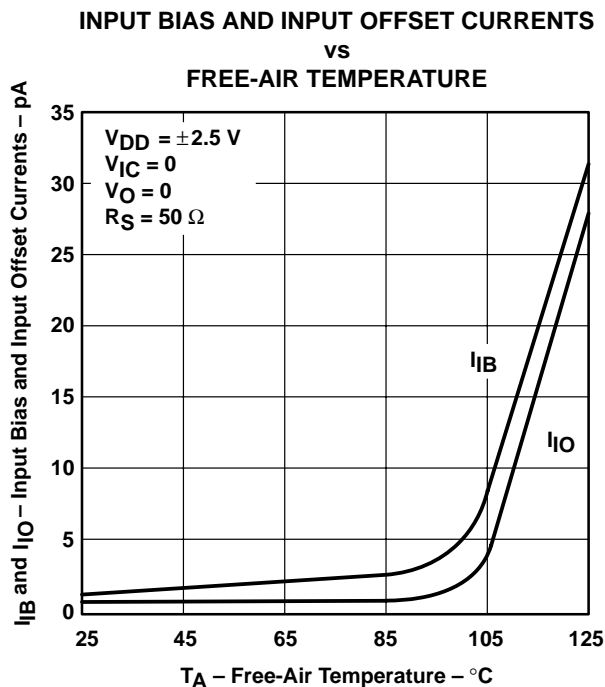

Figure 8

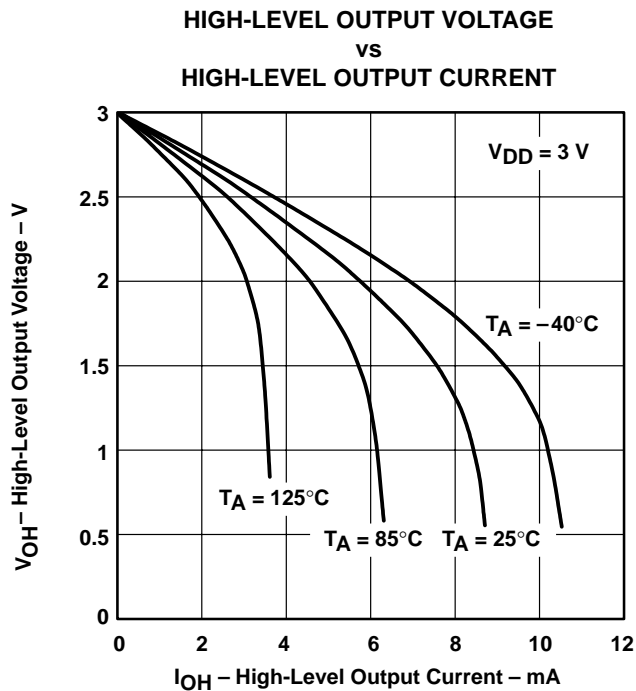

Figure 9

**TLV2442, TLV2442A, TLV2444, TLV2444A**  
**Advanced LinCMOS™ RAIL-TO-RAIL OUTPUT**  
**WIDE-INPUT-VOLTAGE OPERATIONAL AMPLIFIERS**

SLOS169H – NOVEMBER 1996 – REVISED MARCH 2001

**TYPICAL CHARACTERISTICS**

**HIGH-LEVEL OUTPUT VOLTAGE  
vs  
HIGH-LEVEL OUTPUT CURRENT**

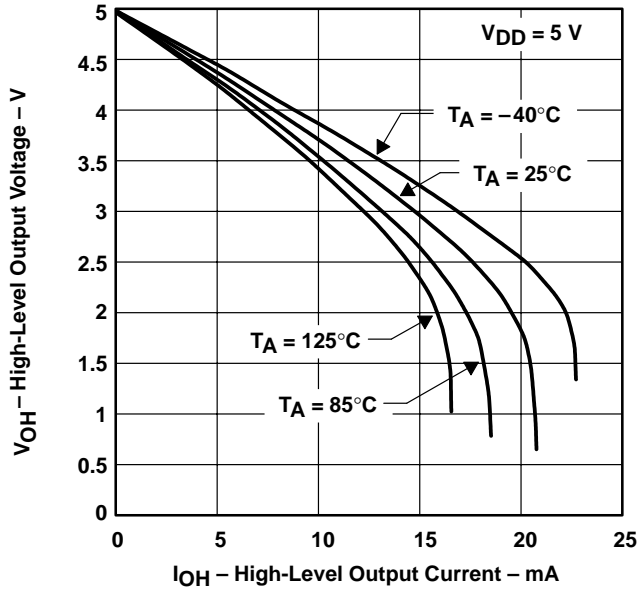

**Figure 10**

**LOW-LEVEL OUTPUT VOLTAGE  
vs  
LOW-LEVEL OUTPUT CURRENT**

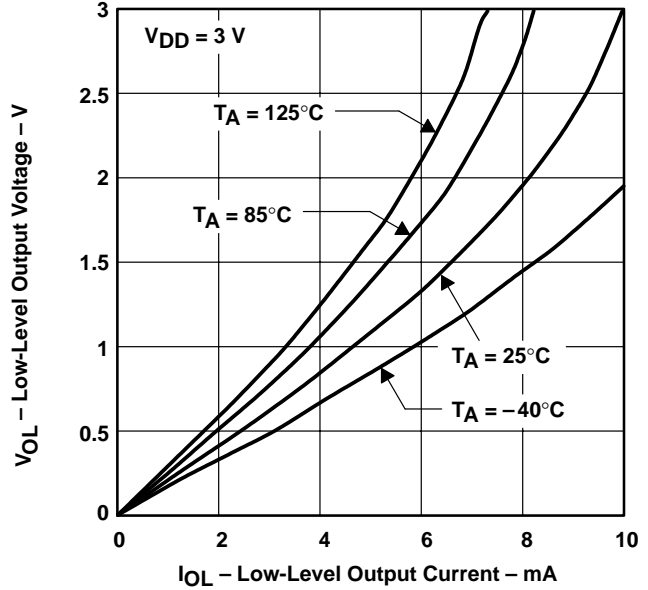

**Figure 11**

**LOW-LEVEL OUTPUT VOLTAGE  
vs  
LOW-LEVEL OUTPUT CURRENT**

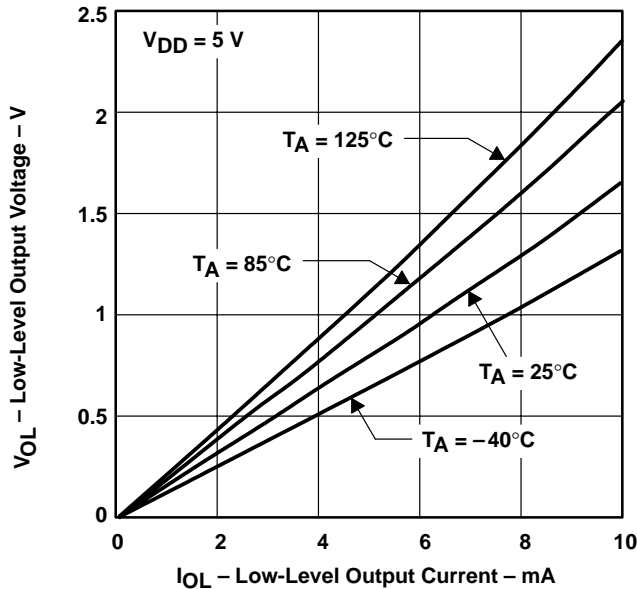

**Figure 12**

**MAXIMUM PEAK-TO-PEAK OUTPUT VOLTAGE  
vs  
FREQUENCY**

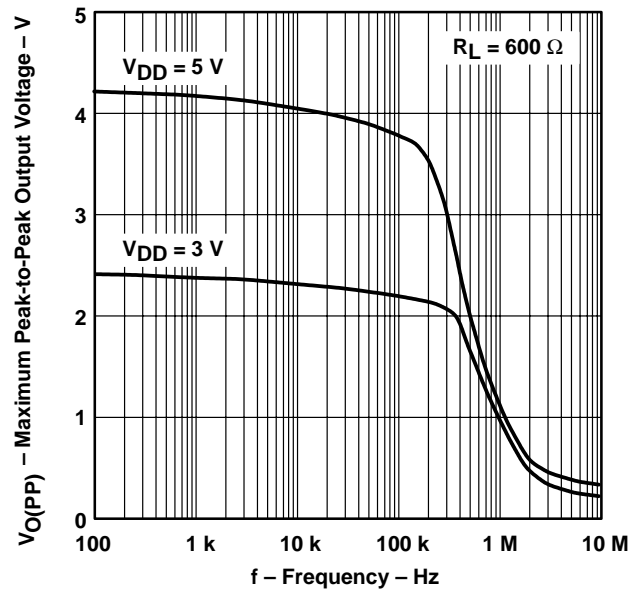

**Figure 13**



TYPICAL CHARACTERISTICS

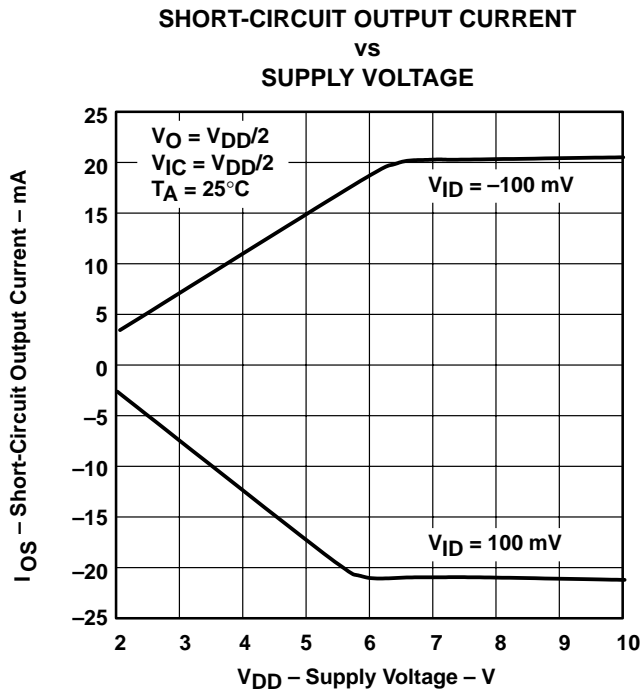

Figure 14

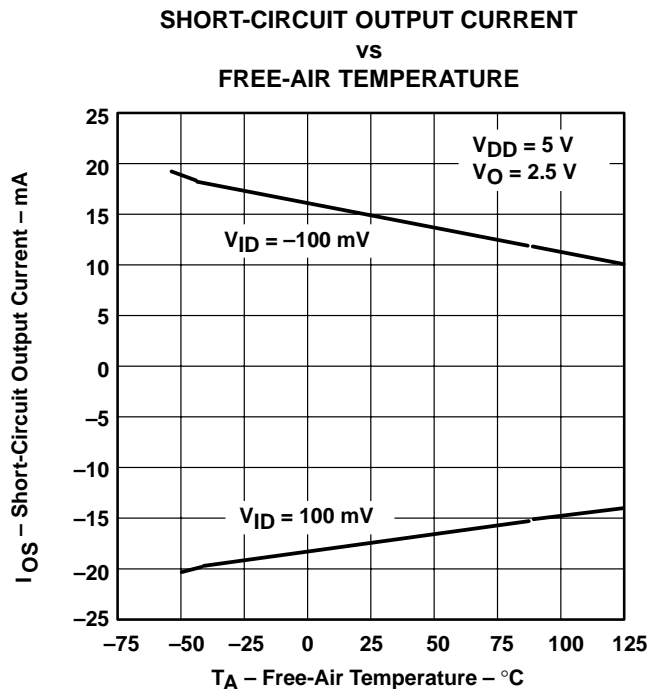

Figure 15

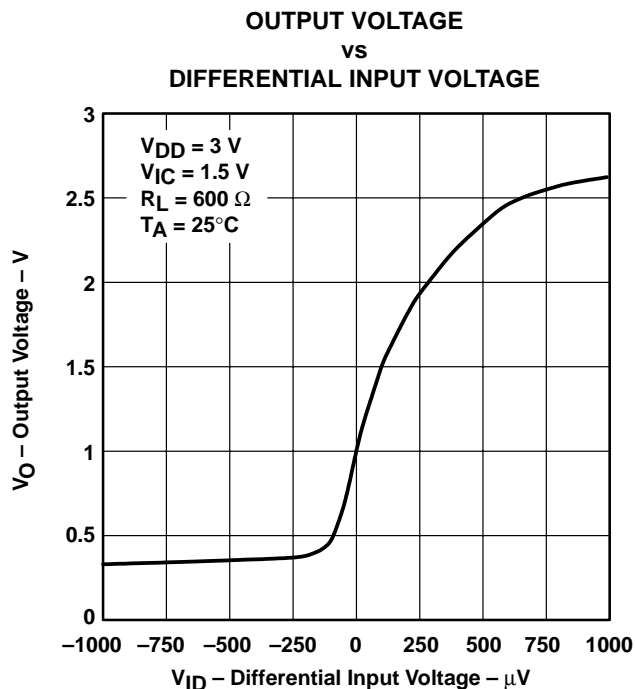

Figure 16

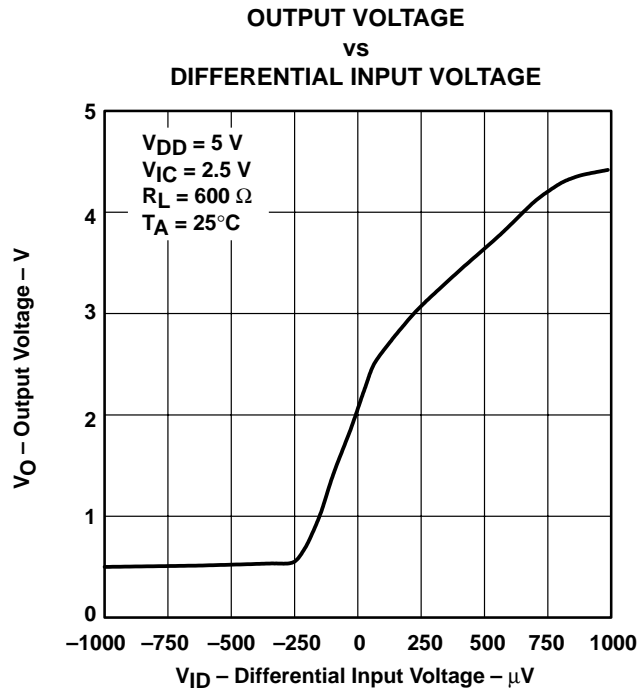

Figure 17

**TLV2442, TLV2442A, TLV2444, TLV2444A**  
**Advanced LinCMOS™ RAIL-TO-RAIL OUTPUT**  
**WIDE-INPUT-VOLTAGE OPERATIONAL AMPLIFIERS**

SLOS169H – NOVEMBER 1996 – REVISED MARCH 2001

**TYPICAL CHARACTERISTICS**

**DIFFERENTIAL VOLTAGE AMPLIFICATION**  
**vs**  
**LOAD RESISTANCE**

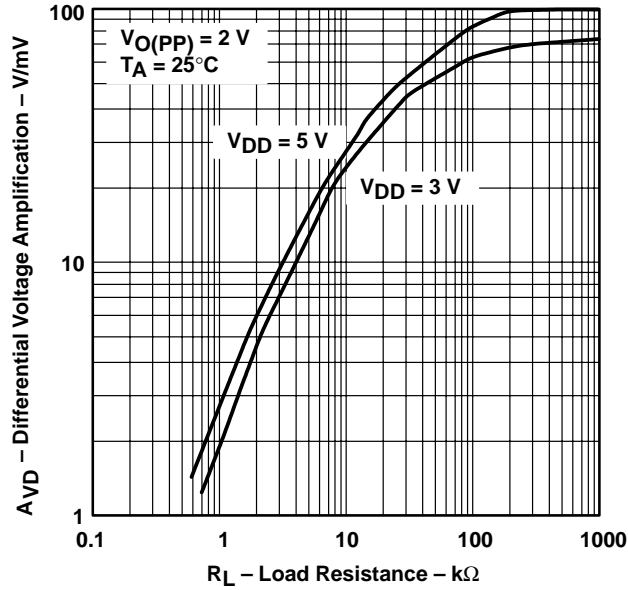

**Figure 18**

**LARGE-SIGNAL DIFFERENTIAL VOLTAGE**  
**AMPLIFICATION AND PHASE MARGIN**  
**vs**  
**FREQUENCY**

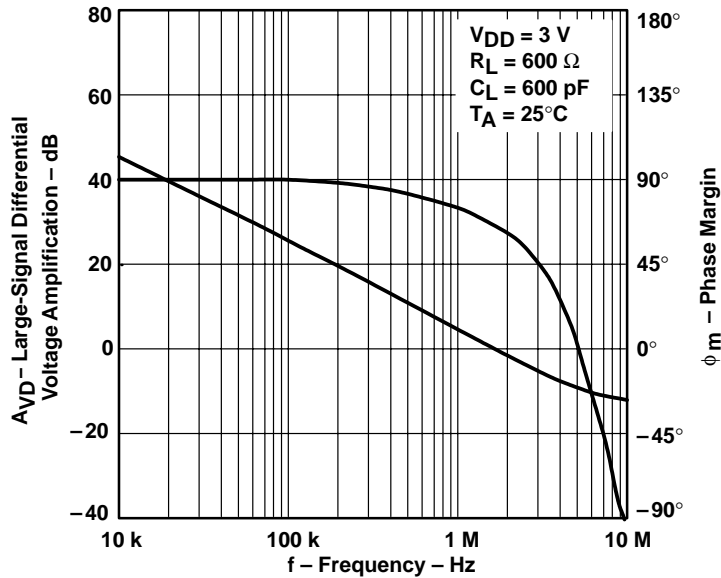

**Figure 19**



TYPICAL CHARACTERISTICS

LARGE-SIGNAL DIFFERENTIAL VOLTAGE  
 AMPLIFICATION AND PHASE MARGIN  
 vs  
 FREQUENCY

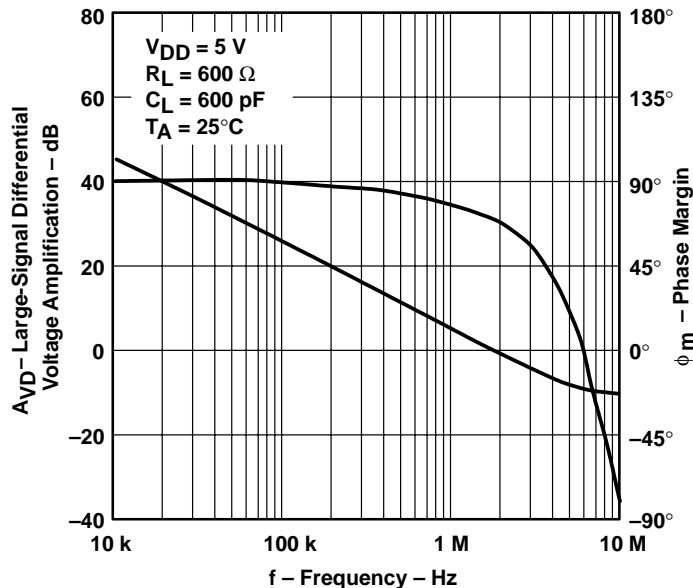

Figure 20

LARGE-SIGNAL DIFFERENTIAL  
 VOLTAGE AMPLIFICATION  
 vs  
 FREE-AIR TEMPERATURE

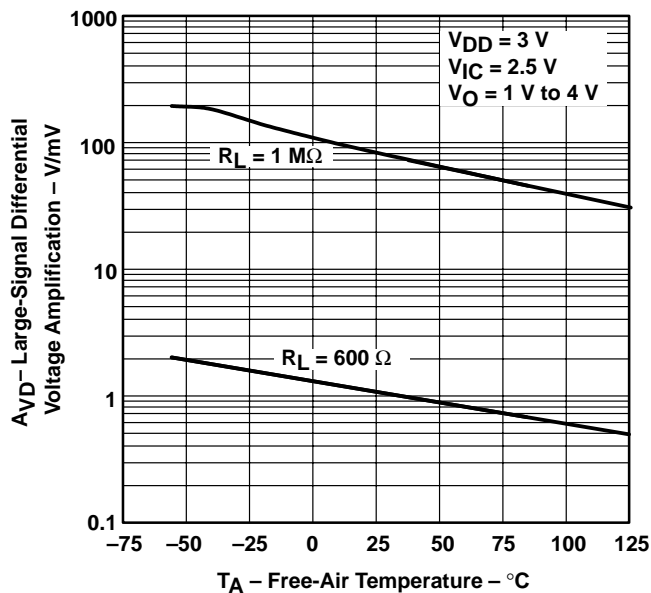

Figure 21

LARGE-SIGNAL DIFFERENTIAL  
 VOLTAGE AMPLIFICATION  
 vs  
 FREE-AIR TEMPERATURE

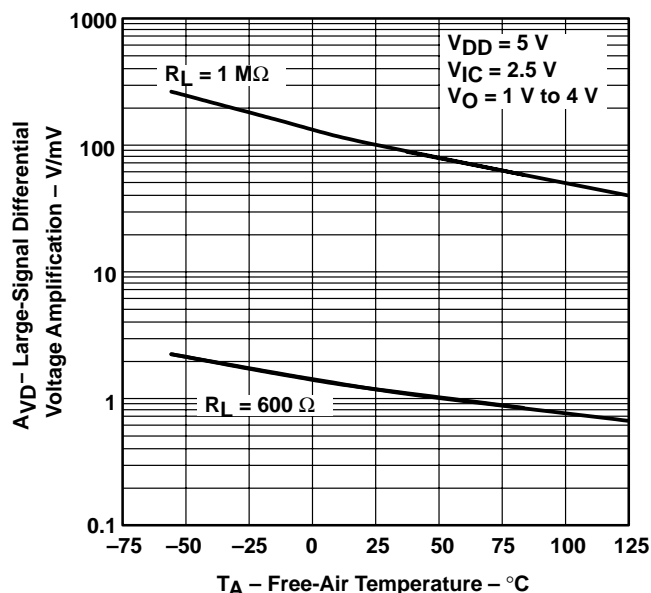

Figure 22

**TLV2442, TLV2442A, TLV2444, TLV2444A**  
**Advanced LinCMOS™ RAIL-TO-RAIL OUTPUT**  
**WIDE-INPUT-VOLTAGE OPERATIONAL AMPLIFIERS**

SLOS169H – NOVEMBER 1996 – REVISED MARCH 2001

**TYPICAL CHARACTERISTICS**

**OUTPUT IMPEDANCE  
 vs  
 FREQUENCY**

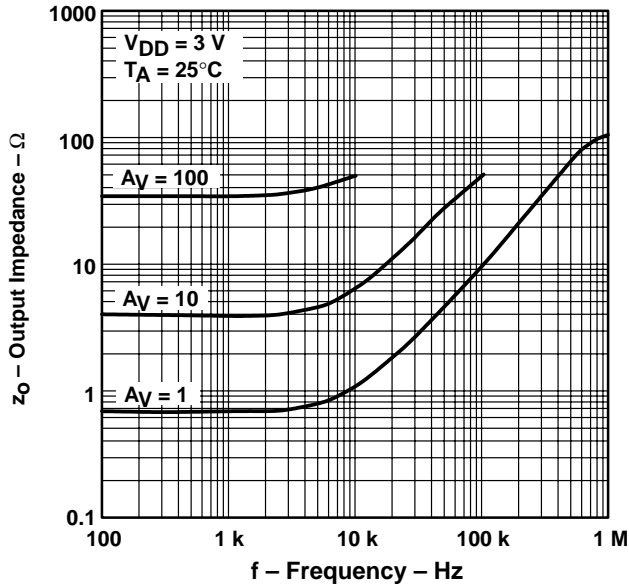

**Figure 23**

**OUTPUT IMPEDANCE  
 vs  
 FREQUENCY**

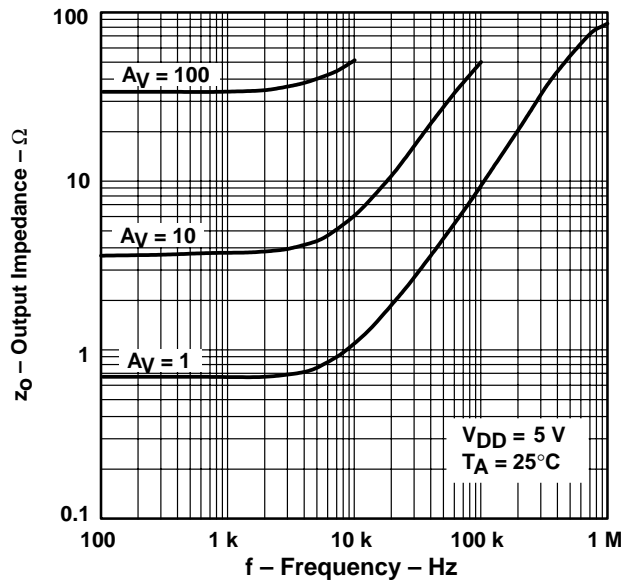

**Figure 24**

**COMMON-MODE REJECTION RATIO  
 vs  
 FREQUENCY**

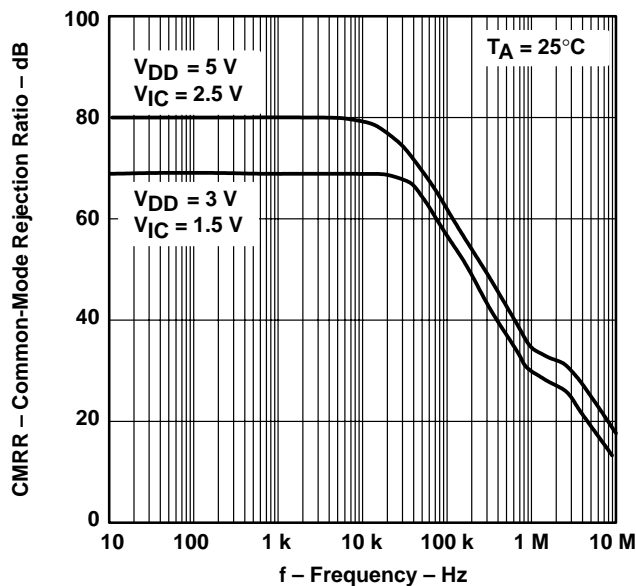

**Figure 25**

**COMMON-MODE REJECTION RATIO  
 vs  
 FREE-AIR TEMPERATURE**

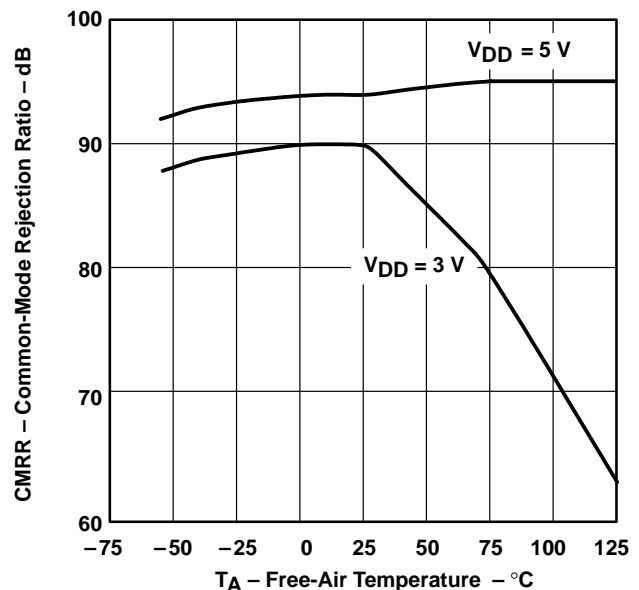

**Figure 26**



TYPICAL CHARACTERISTICS

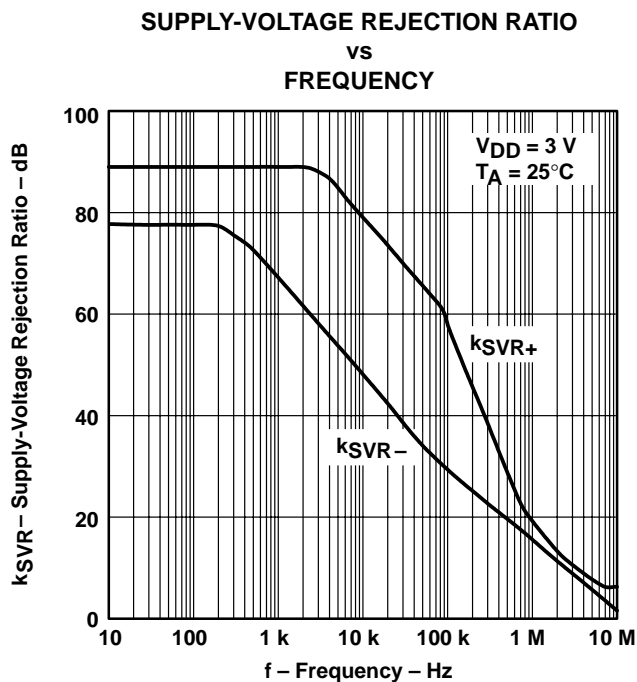

Figure 27

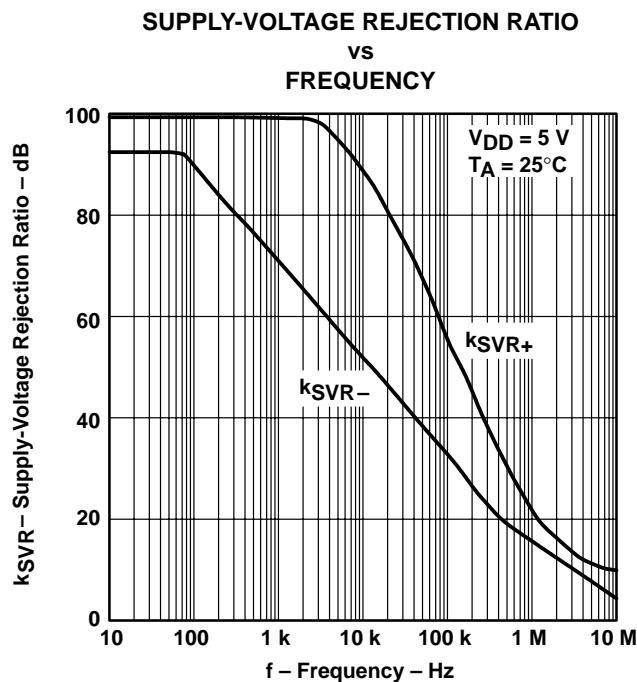

Figure 28

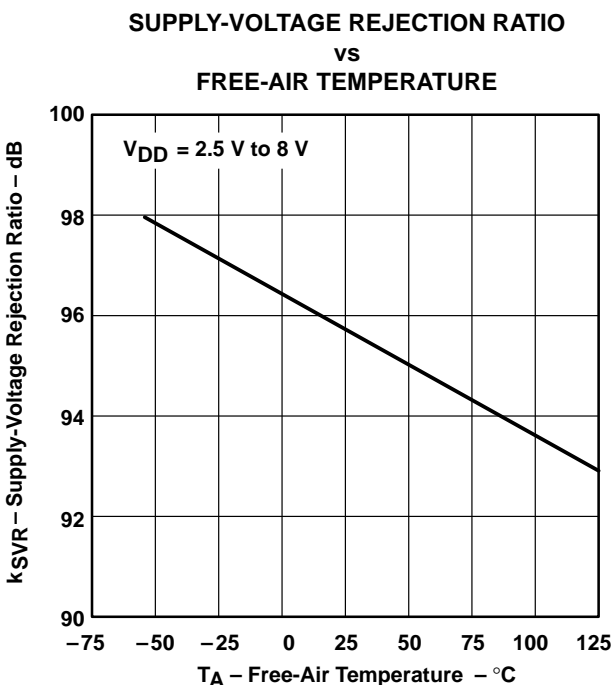

Figure 29

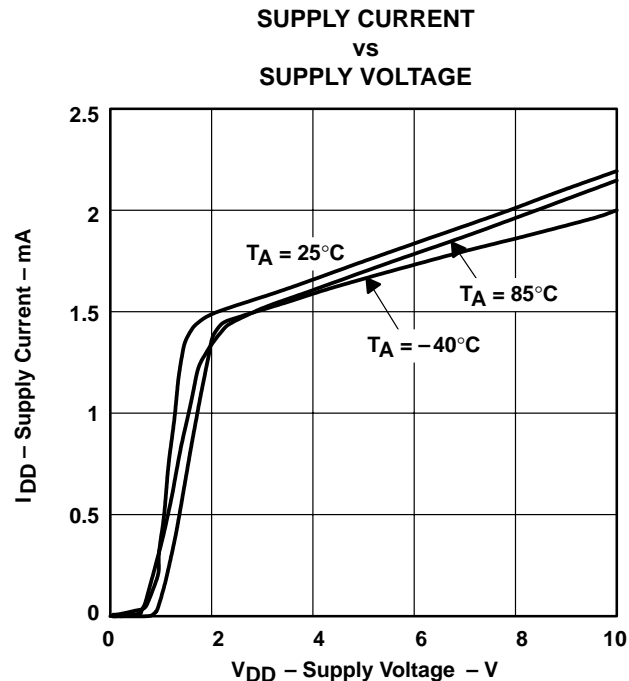

Figure 30

**TLV2442, TLV2442A, TLV2444, TLV2444A**  
**Advanced LinCMOS™ RAIL-TO-RAIL OUTPUT**  
**WIDE-INPUT-VOLTAGE OPERATIONAL AMPLIFIERS**

SLOS169H – NOVEMBER 1996 – REVISED MARCH 2001

**TYPICAL CHARACTERISTICS**

**SLEW RATE  
vs  
LOAD CAPACITANCE**

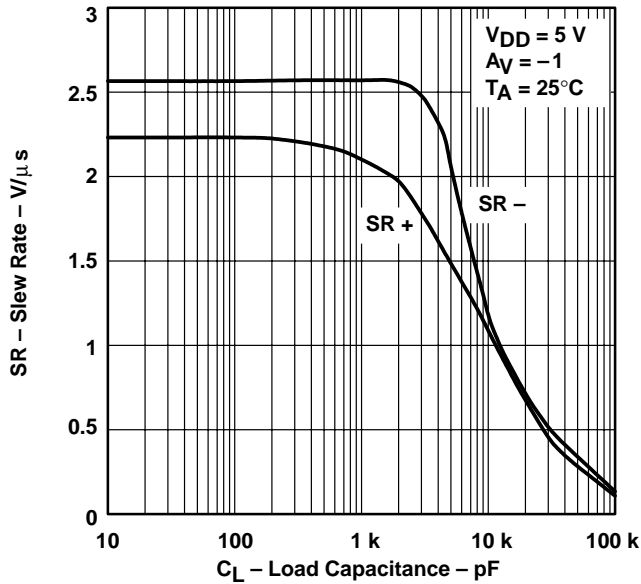

**Figure 31**

**SLEW RATE  
vs  
FREE-AIR TEMPERATURE**

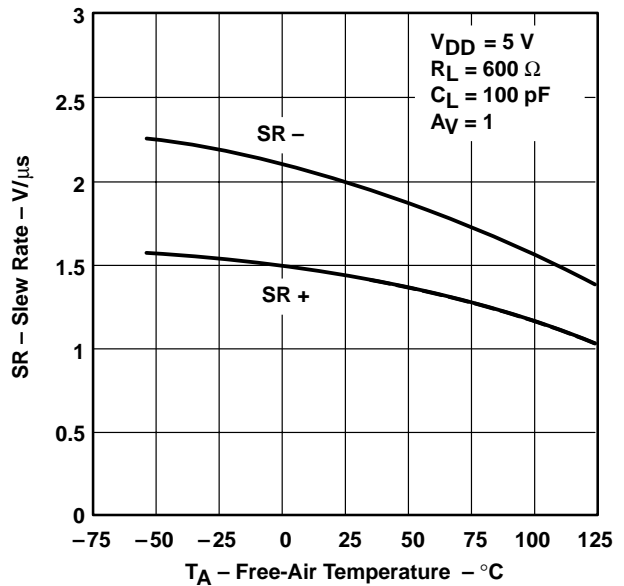

**Figure 32**

**INVERTING LARGE-SIGNAL PULSE RESPONSE**

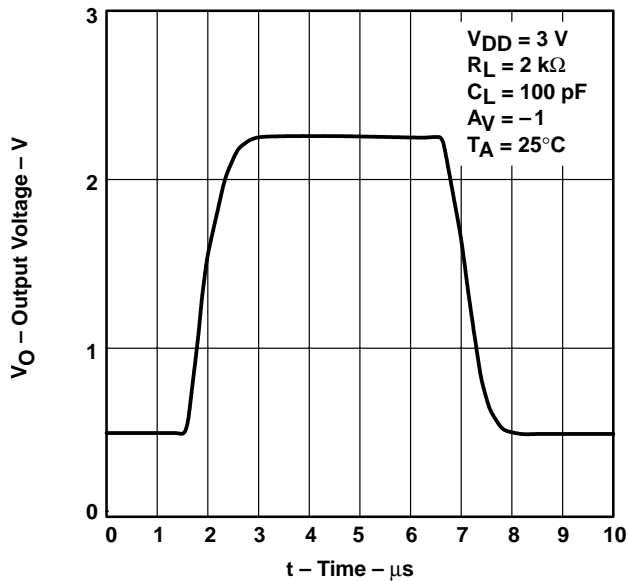

**Figure 33**

**INVERTING LARGE-SIGNAL PULSE RESPONSE**

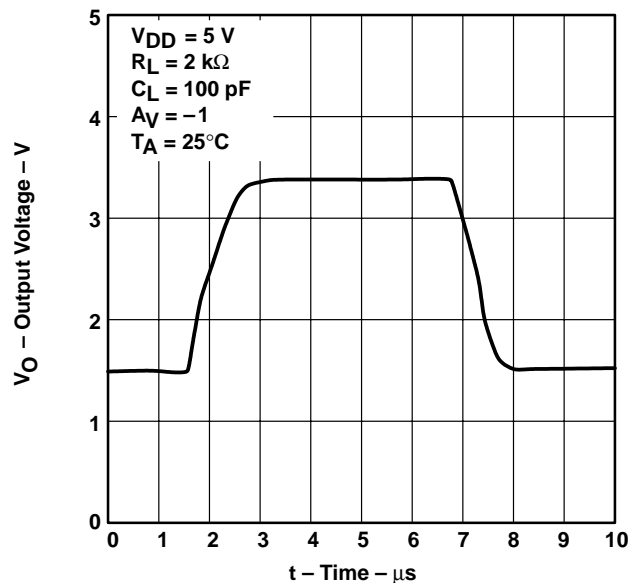

**Figure 34**



TYPICAL CHARACTERISTICS

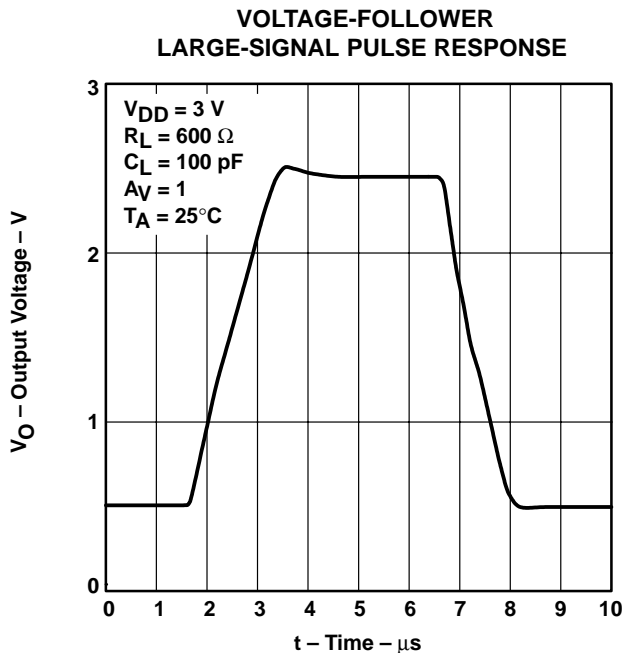

Figure 35

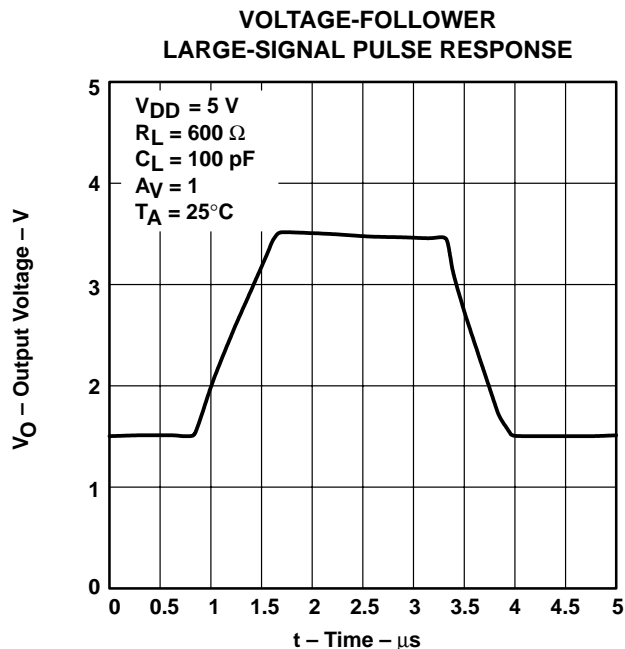

Figure 36

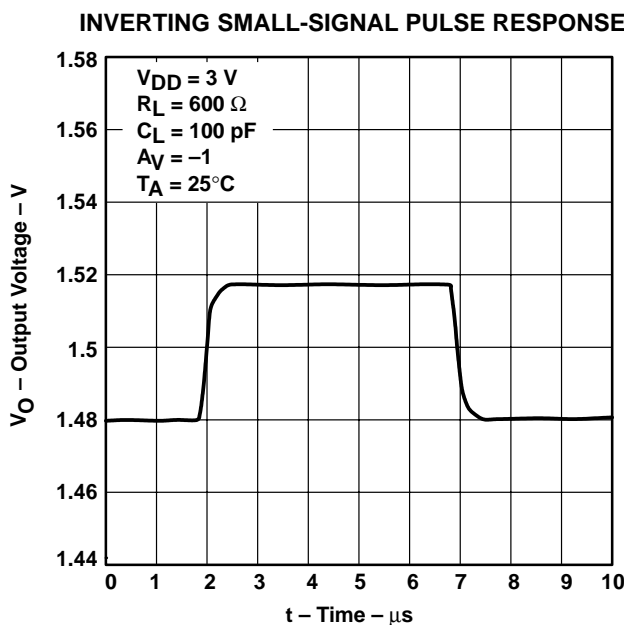

Figure 37

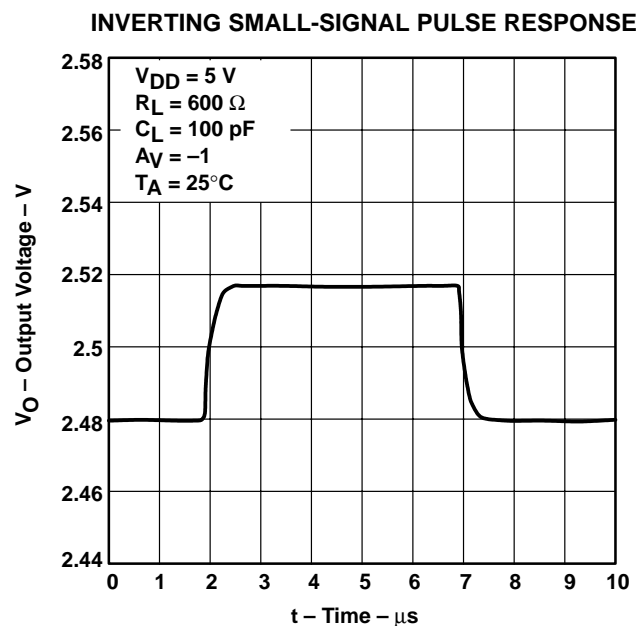

Figure 38

**TLV2442, TLV2442A, TLV2444, TLV2444A**  
**Advanced LinCMOS™ RAIL-TO-RAIL OUTPUT**  
**WIDE-INPUT-VOLTAGE OPERATIONAL AMPLIFIERS**

SLOS169H – NOVEMBER 1996 – REVISED MARCH 2001

**TYPICAL CHARACTERISTICS**

**VOLTAGE-FOLLOWER  
 SMALL-SIGNAL PULSE RESPONSE**

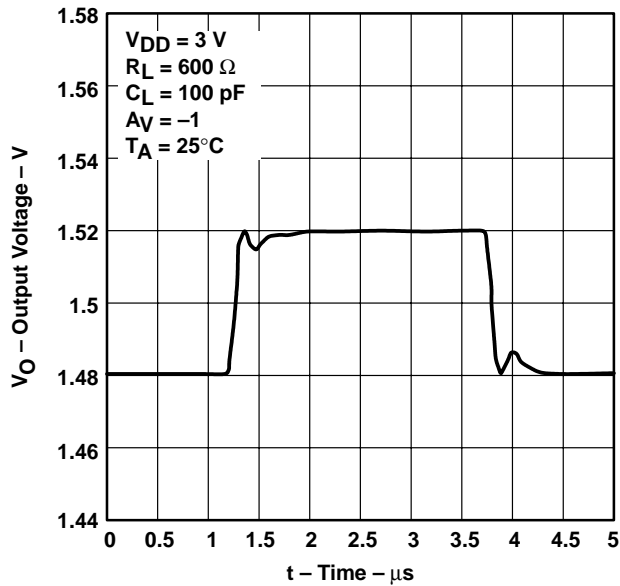

**Figure 39**

**VOLTAGE-FOLLOWER  
 SMALL-SIGNAL PULSE RESPONSE**

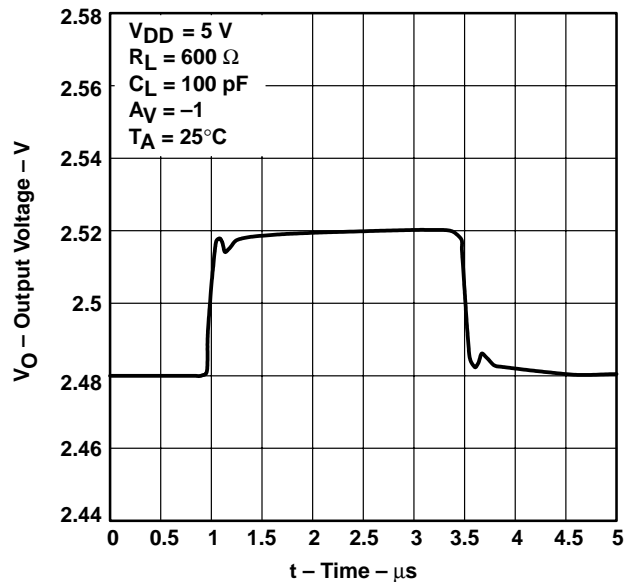

**Figure 40**

**EQUIVALENT INPUT NOISE VOLTAGE  
 VS  
 FREQUENCY**

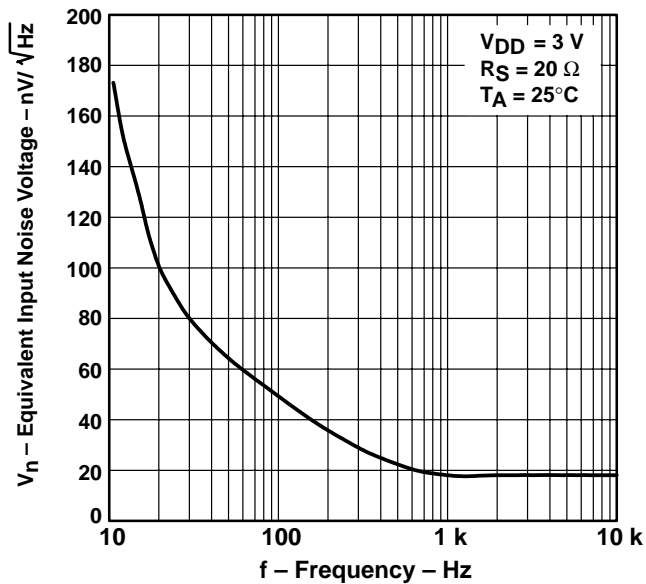

**Figure 41**

**EQUIVALENT INPUT NOISE VOLTAGE  
 VS  
 FREQUENCY**

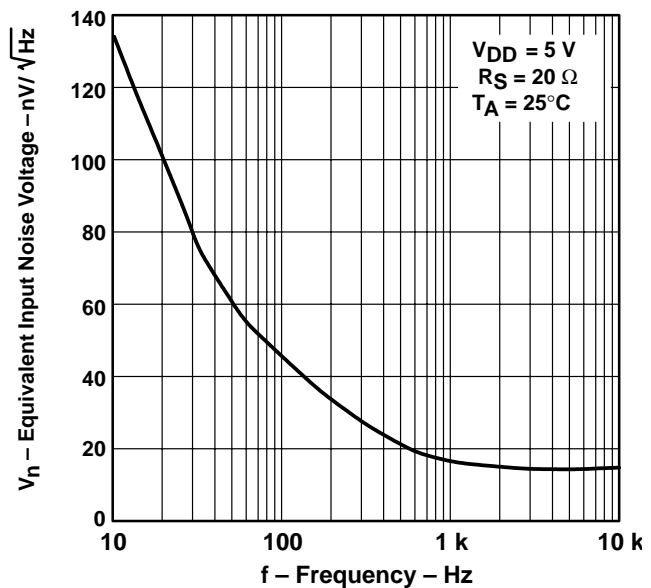

**Figure 42**



TYPICAL CHARACTERISTICS

NOISE VOLTAGE  
 OVER A 10-SECOND PERIOD

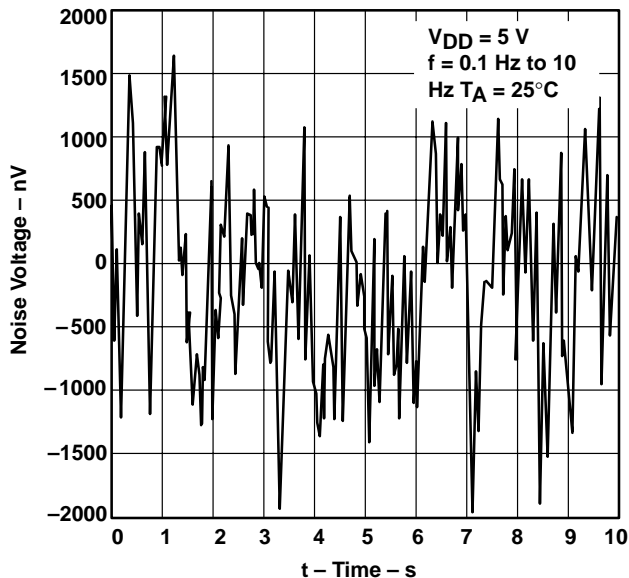

Figure 43

TOTAL HARMONIC DISTORTION PLUS NOISE  
 VS  
 FREQUENCY

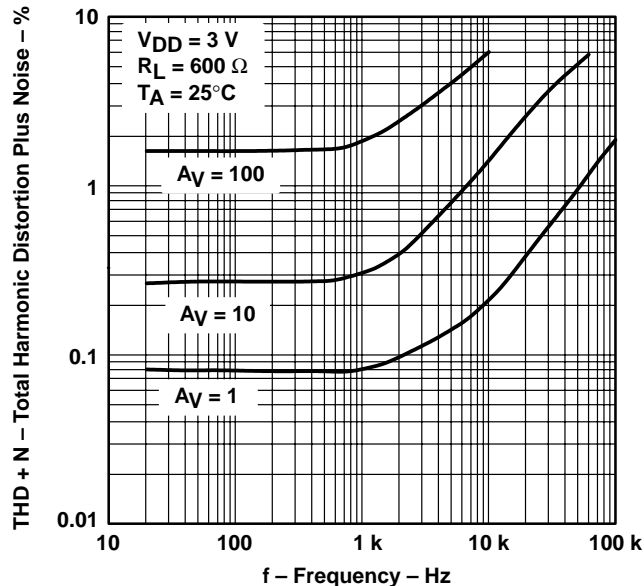

Figure 44

TOTAL HARMONIC DISTORTION PLUS NOISE  
 VS  
 FREQUENCY

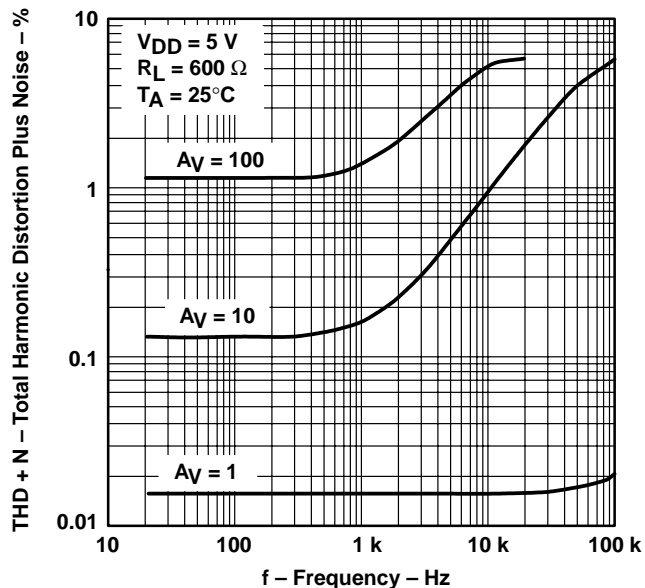

Figure 45

GAIN-BANDWIDTH PRODUCT  
 VS  
 FREE-AIR TEMPERATURE

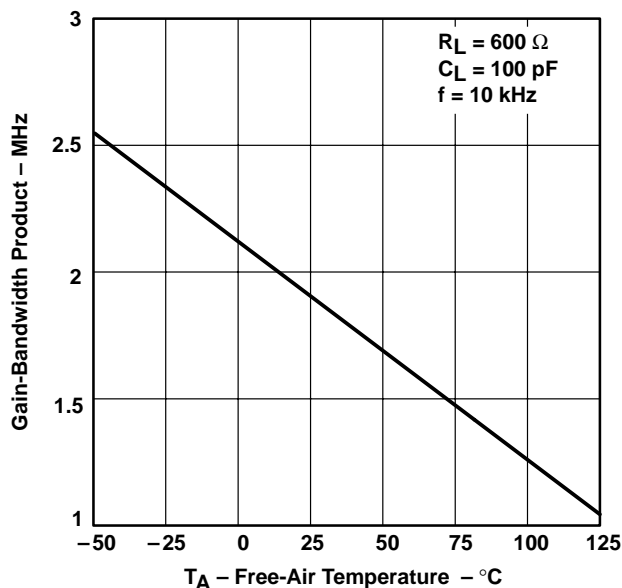

Figure 46

**TLV2442, TLV2442A, TLV2444, TLV2444A**  
**Advanced LinCMOS™ RAIL-TO-RAIL OUTPUT**  
**WIDE-INPUT-VOLTAGE OPERATIONAL AMPLIFIERS**

SLOS169H – NOVEMBER 1996 – REVISED MARCH 2001

**TYPICAL CHARACTERISTICS**

**GAIN-BANDWIDTH PRODUCT**  
**vs**  
**SUPPLY VOLTAGE**

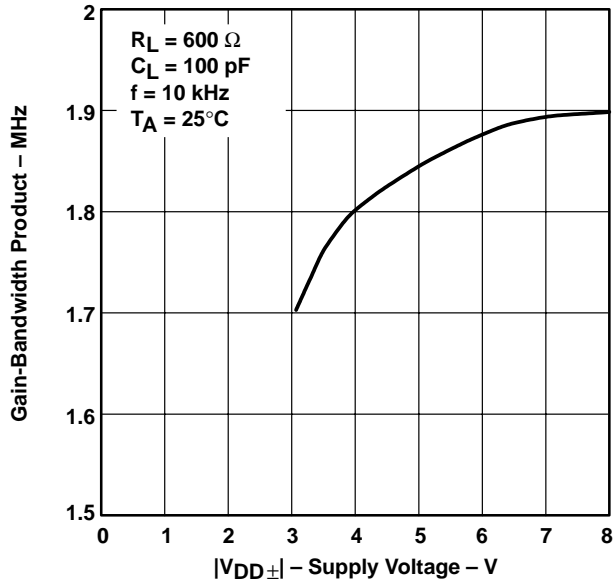

**Figure 47**

**PHASE MARGIN**  
**vs**  
**LOAD CAPACITANCE**

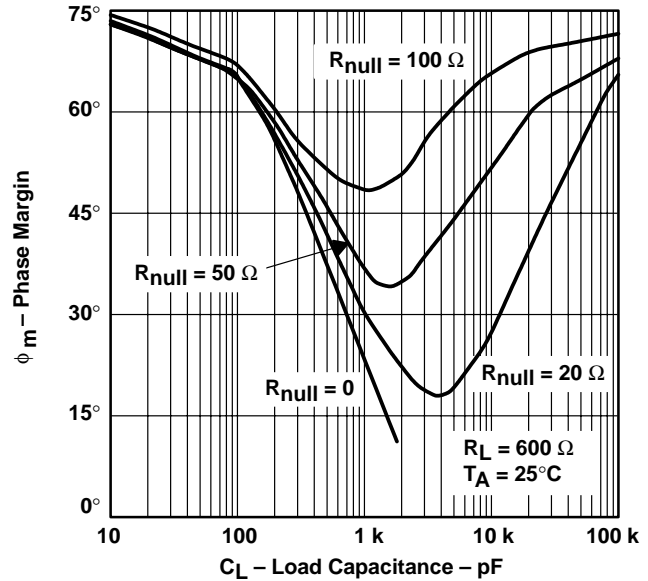

**Figure 48**

**GAIN MARGIN**  
**vs**  
**LOAD CAPACITANCE**

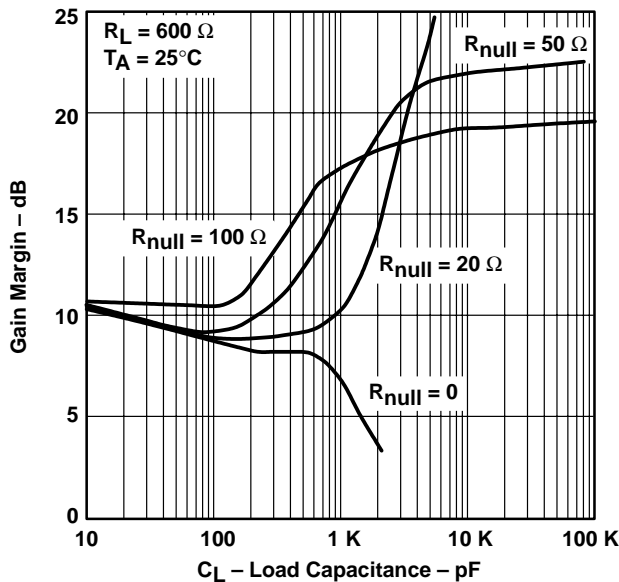

**Figure 49**

**UNITY-GAIN BANDWIDTH**  
**vs**  
**LOAD CAPACITANCE**

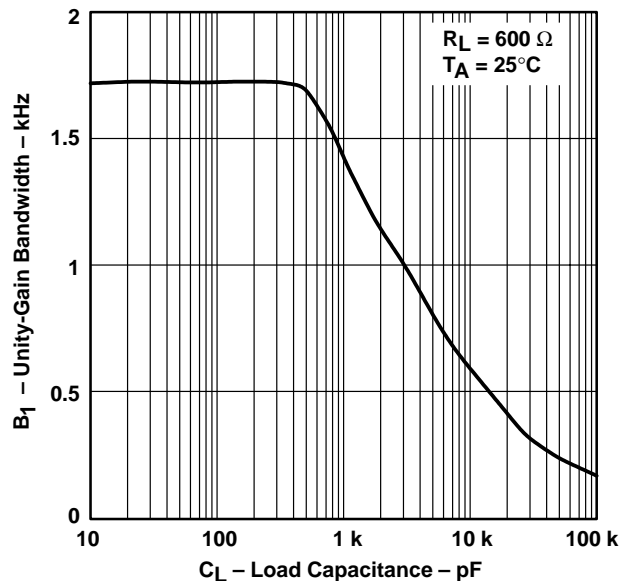

**Figure 50**



# TLV2442, TLV2442A, TLV2444, TLV2444A Advanced LinCMOS™ RAIL-TO-RAIL OUTPUT WIDE-INPUT-VOLTAGE OPERATIONAL AMPLIFIERS

SLOS169H – NOVEMBER 1996 – REVISED MARCH 2001

## APPLICATION INFORMATION

### macromodel information

Macromodel information provided was derived using *PSpice™ Parts™* model generation software. The Boyle macromodel (see Note 5) and subcircuit in Figure 51 were generated using the TLV244x typical electrical and operating characteristics at  $T_A = 25^\circ\text{C}$ . Using this information, output simulations of the following key parameters can be generated to a tolerance of 20% (in most cases):

- Maximum positive output voltage swing
- Maximum negative output voltage swing
- Slew rate
- Quiescent power dissipation
- Input bias current
- Open-loop voltage amplification
- Unity gain frequency
- Common-mode rejection ratio
- Phase margin
- DC output resistance
- AC output resistance
- Short-circuit output current limit

NOTE 5: G. R. Boyle, B. M. Cohn, D. O. Pederson, and J. E. Solomon, "Macromodeling of Integrated Circuit Operational Amplifiers," *IEEE Journal of Solid-State Circuits*, SC-9, 353 (1974).

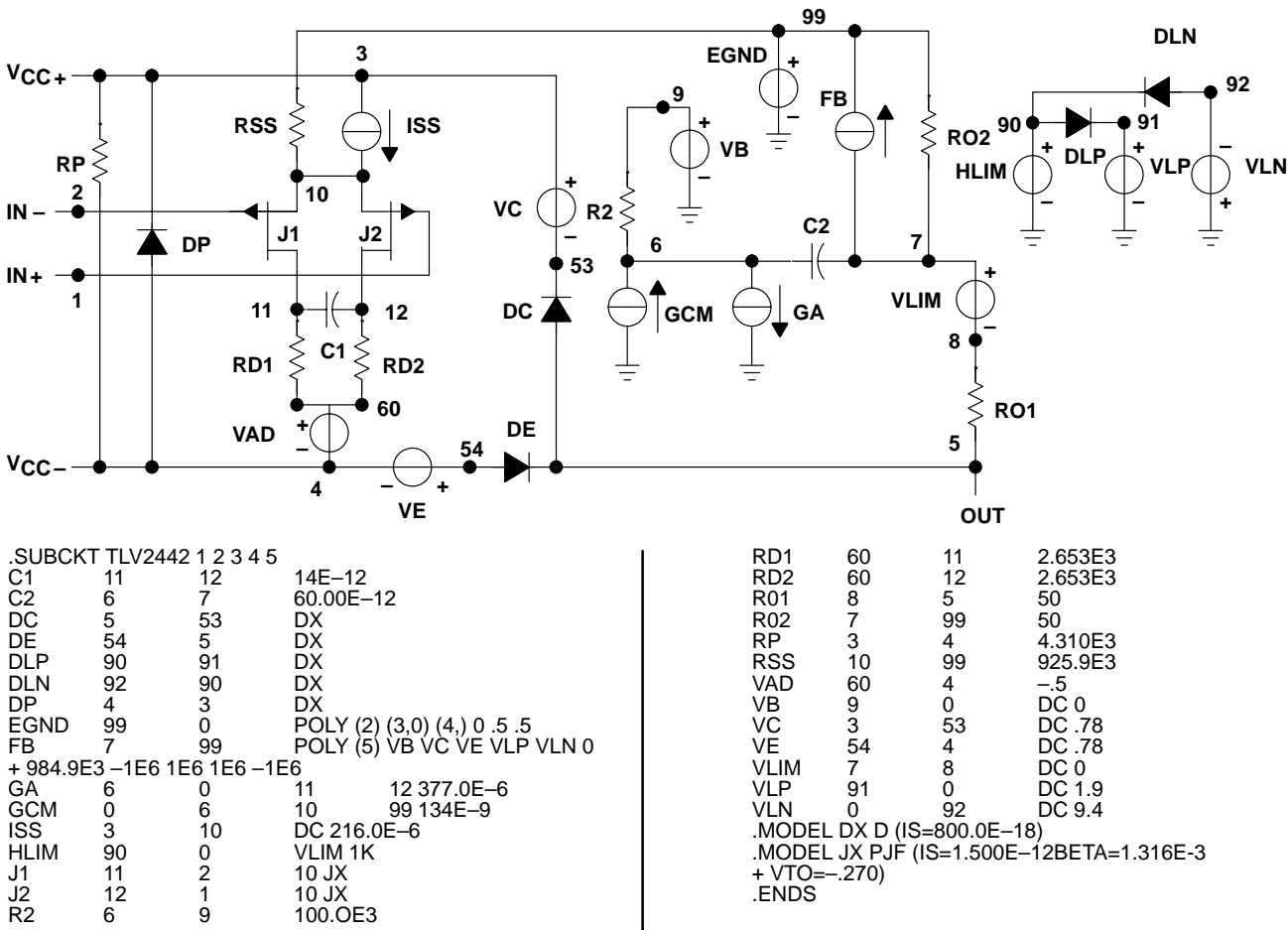

Figure 51. Boyle Macromodel and Subcircuit

*PSpice* and *Parts* are registered trademarks of MicroSim Corporation.



**TLV2442, TLV2442A, TLV2444, TLV2444A**  
**Advanced LinCMOS™ RAIL-TO-RAIL OUTPUT**  
**WIDE-INPUT-VOLTAGE OPERATIONAL AMPLIFIERS**

SLOS169H – NOVEMBER 1996 – REVISED MARCH 2001

**MECHANICAL DATA**

**D (R-PDSO-G\*\*)**

**PLASTIC SMALL-OUTLINE PACKAGE**

14 PIN SHOWN

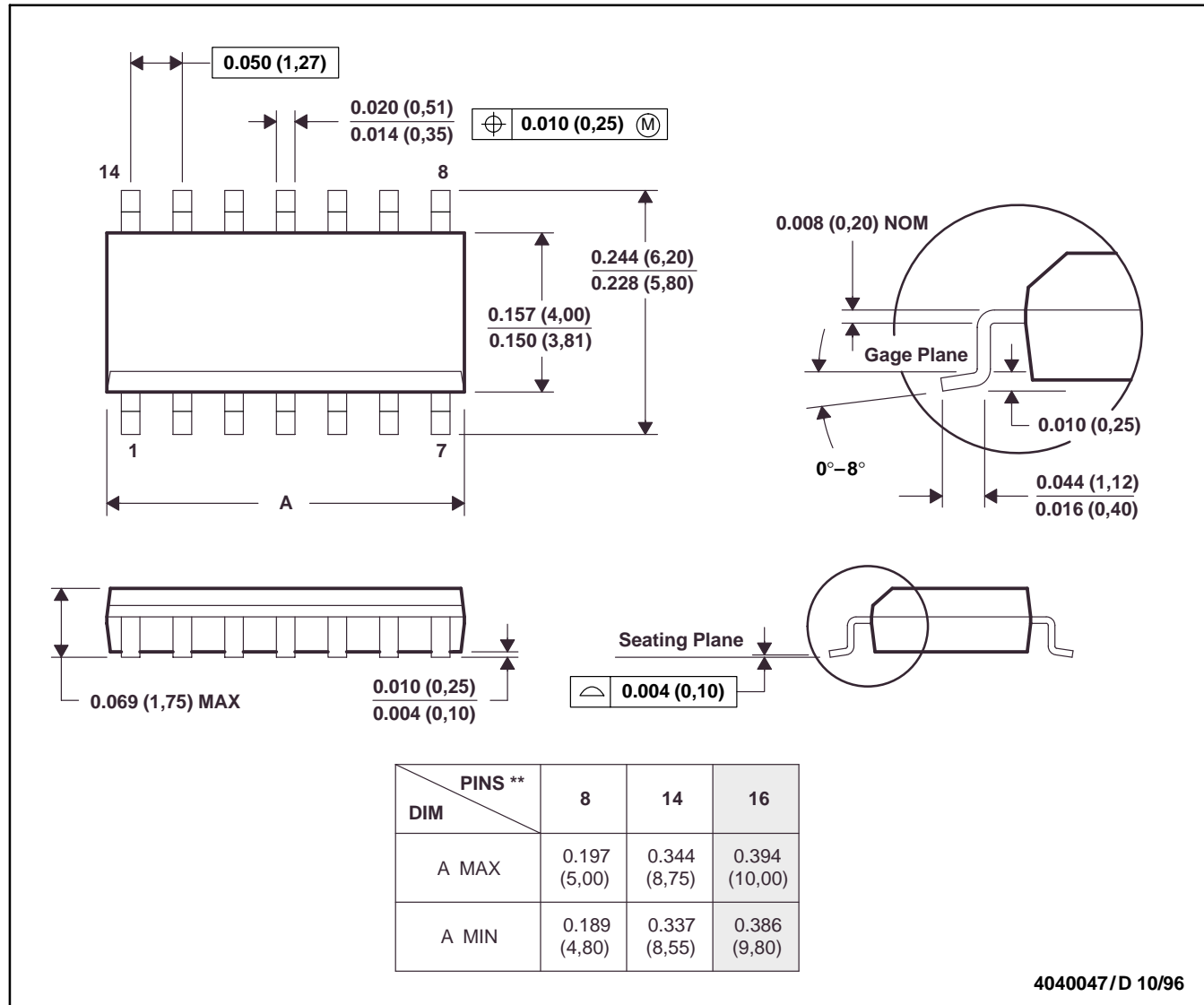

- NOTES: A. All linear dimensions are in inches (millimeters).  
 B. This drawing is subject to change without notice.  
 C. Body dimensions do not include mold flash or protrusion, not to exceed 0.006 (0,15).  
 D. Falls within JEDEC MS-012

**TLV2442, TLV2442A, TLV2444, TLV2444A**  
**Advanced LinCMOS™ RAIL-TO-RAIL OUTPUT**  
**WIDE-INPUT-VOLTAGE OPERATIONAL AMPLIFIERS**

SLOS169H – NOVEMBER 1996 – REVISED MARCH 2001

**MECHANICAL DATA**

**FK (S-CQCC-N\*\*)**

**LEADLESS CERAMIC CHIP CARRIER**

28 TERMINAL SHOWN

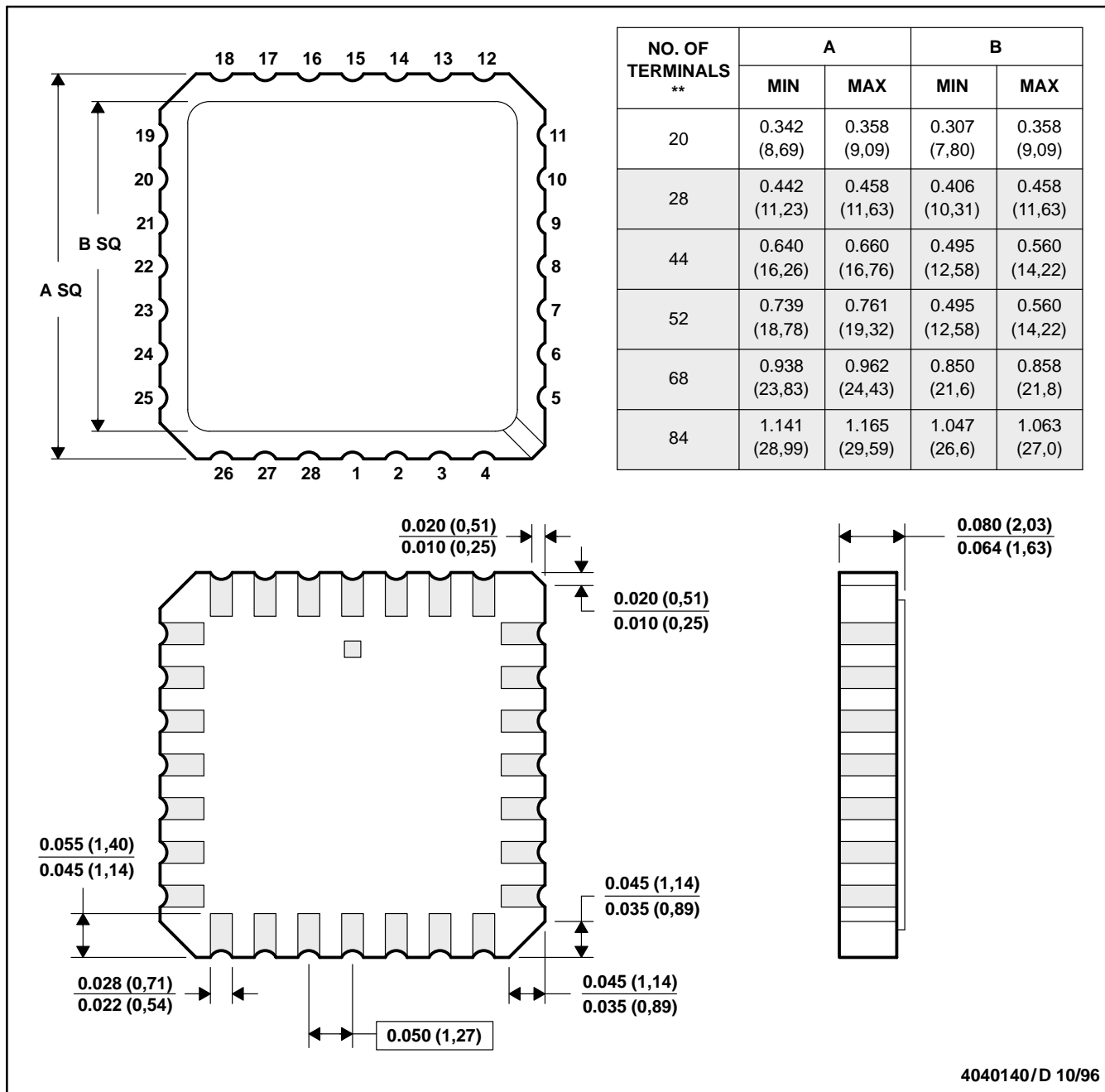

- NOTES: A. All linear dimensions are in inches (millimeters).  
 B. This drawing is subject to change without notice.  
 C. This package can be hermetically sealed with a metal lid.  
 D. The terminals are gold plated.  
 E. Falls within JEDEC MS-004

**TLV2442, TLV2442A, TLV2444, TLV2444A**  
**Advanced LinCMOS™ RAIL-TO-RAIL OUTPUT**  
**WIDE-INPUT-VOLTAGE OPERATIONAL AMPLIFIERS**

SLOS169H – NOVEMBER 1996 – REVISED MARCH 2001

**MECHANICAL DATA**

**JG (R-GDIP-T8)**

**CERAMIC DUAL-IN-LINE PACKAGE**

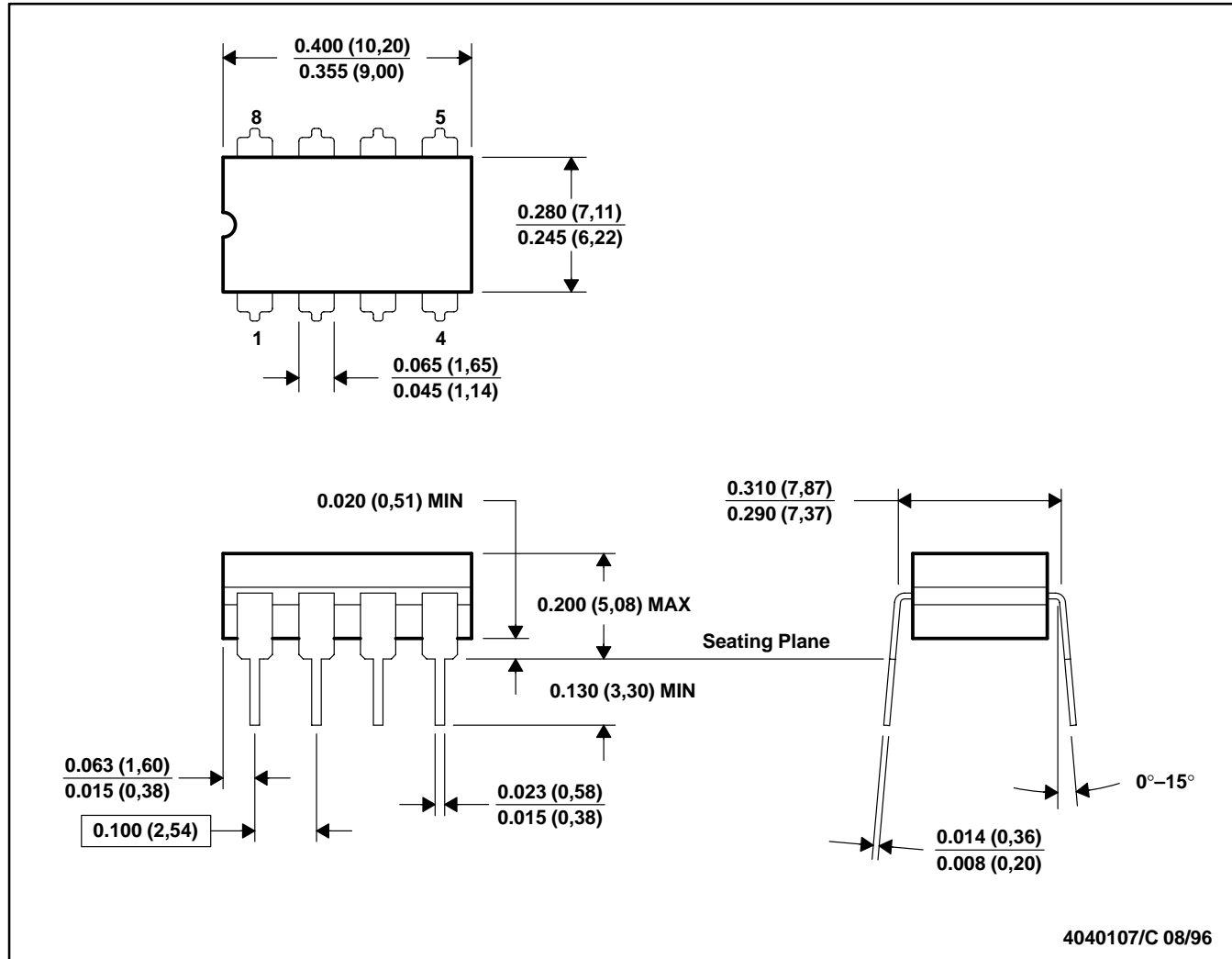

- NOTES: A. All linear dimensions are in inches (millimeters).  
 B. This drawing is subject to change without notice.  
 C. This package can be hermetically sealed with a ceramic lid using glass frit.  
 D. Index point is provided on cap for terminal identification on press ceramic glass frit seal only.  
 E. Falls within MIL-STD-1835 GDIP1-T8



POST OFFICE BOX 655303 • DALLAS, TEXAS 75265

TLV2442, TLV2442A, TLV2444, TLV2444A  
 Advanced LinCMOS™ RAIL-TO-RAIL OUTPUT  
 WIDE-INPUT-VOLTAGE OPERATIONAL AMPLIFIERS

SLOS169H – NOVEMBER 1996 – REVISED MARCH 2001

MECHANICAL DATA

PW (R-PDSO-G\*\*)

PLASTIC SMALL-OUTLINE PACKAGE

14 PIN SHOWN

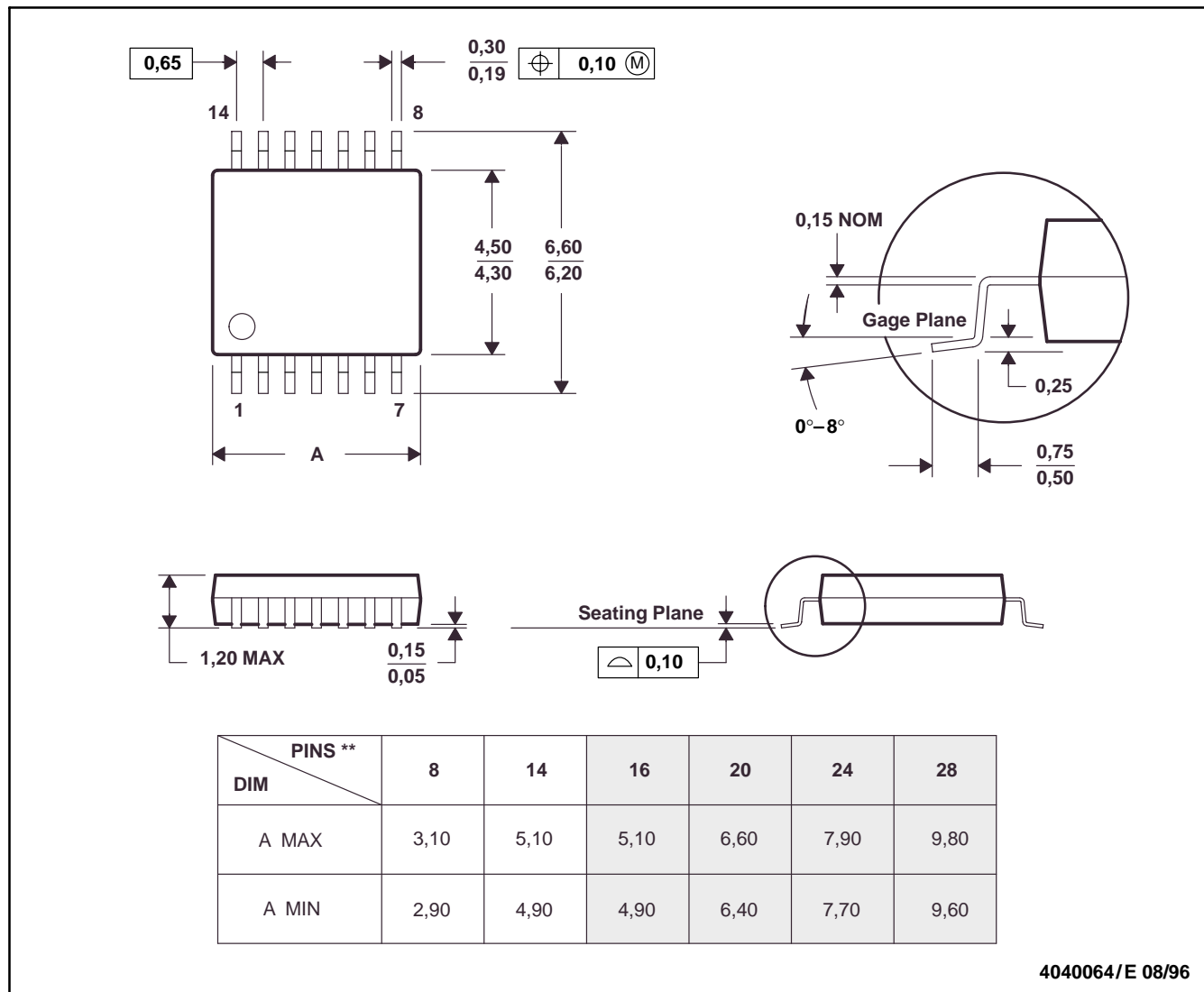

4040064/E 08/96

- NOTES: A. All linear dimensions are in millimeters.  
 B. This drawing is subject to change without notice.  
 C. Body dimensions do not include mold flash or protrusion not to exceed 0,15.  
 D. Falls within JEDEC MO-153

**TLV2442, TLV2442A, TLV2444, TLV2444A**  
**Advanced LinCMOS™ RAIL-TO-RAIL OUTPUT**  
**WIDE-INPUT-VOLTAGE OPERATIONAL AMPLIFIERS**

SLOS169H – NOVEMBER 1996 – REVISED MARCH 2001

**MECHANICAL DATA**

**U (S-GDFP-F10)**

**CERAMIC DUAL FLATPACK**

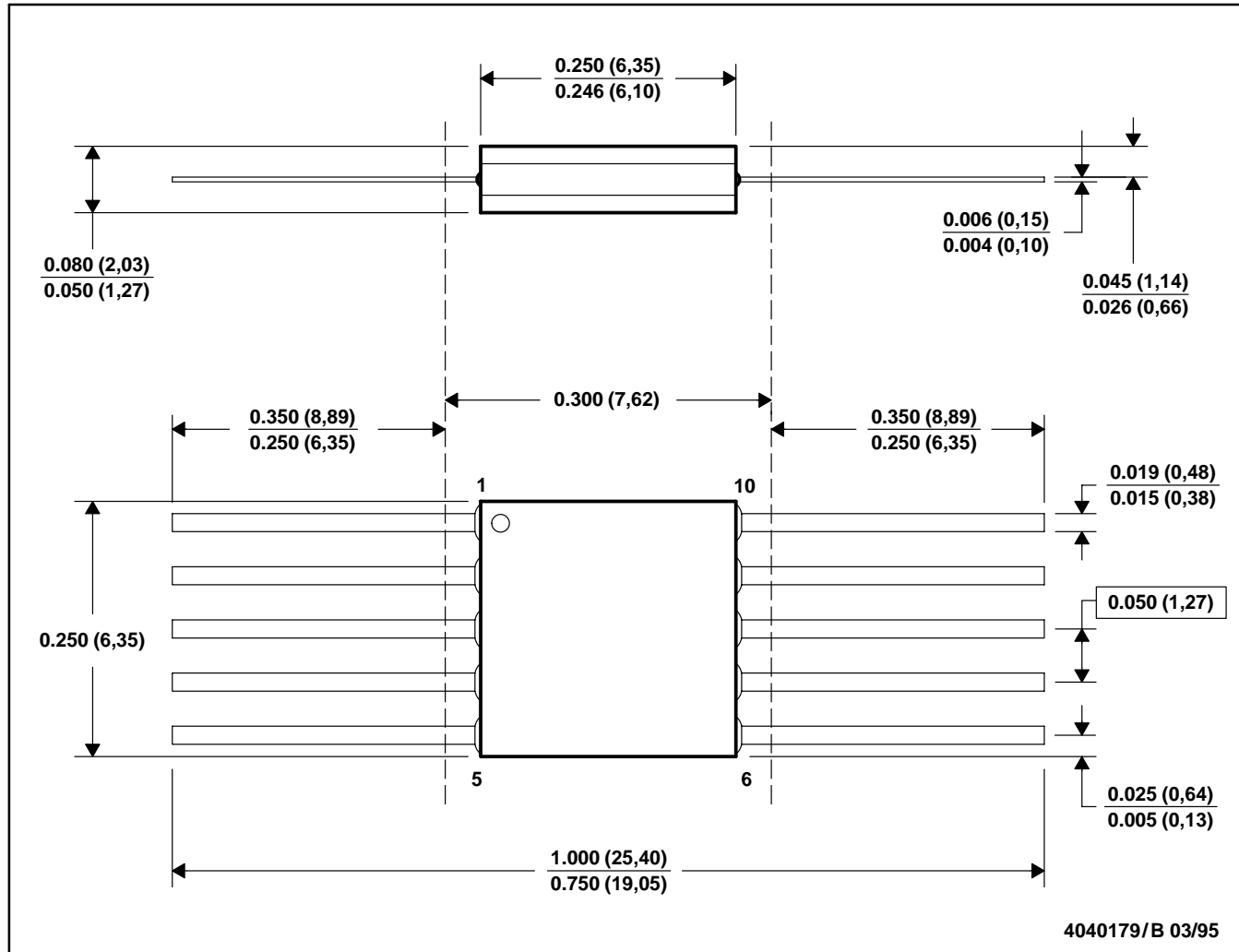

4040179/B 03/95

- NOTES: A. All linear dimensions are in inches (millimeters).  
 B. This drawing is subject to change without notice.  
 C. This package can be hermetically sealed with a ceramic lid using glass frit.  
 D. Index point is provided on cap for terminal identification only.  
 E. Falls within MIL STD 1835 GDFP1-F10 and JEDEC MO-092AA



POST OFFICE BOX 655303 • DALLAS, TEXAS 75265

**PACKAGING INFORMATION**

Orderable Device	Status (1)	Package Type	Package Drawing	Pins	Package Qty	Eco Plan (2)	Lead finish/ Ball material (6)	MSL Peak Temp (3)	Op Temp (°C)	Device Marking (4/5)	Samples
5962-9751101QPA	ACTIVE	CDIP	JG	8	50	TBD	Call TI	Call TI	-55 to 125	9751101QPA TLV2442M	<a href="#">Samples</a>
5962-9751102QPA	ACTIVE	CDIP	JG	8	50	TBD	Call TI	Call TI	-55 to 125	9751102QPA TLV2442AM	<a href="#">Samples</a>
TLV2442AID	ACTIVE	SOIC	D	8	75	RoHS & Green	NIPDAU	Level-1-260C-UNLIM	-40 to 85	2442AI	<a href="#">Samples</a>
TLV2442AIDR	ACTIVE	SOIC	D	8	2500	RoHS & Green	NIPDAU	Level-1-260C-UNLIM	-40 to 85	2442AI	<a href="#">Samples</a>
TLV2442AIPW	ACTIVE	TSSOP	PW	8	150	RoHS & Green	NIPDAU	Level-1-260C-UNLIM	-40 to 85	TV2442	<a href="#">Samples</a>
TLV2442AIPWR	ACTIVE	TSSOP	PW	8	2000	RoHS & Green	NIPDAU	Level-1-260C-UNLIM	-40 to 85	2442AI	<a href="#">Samples</a>
TLV2442AMJGB	ACTIVE	CDIP	JG	8	50	TBD	Call TI	Call TI	-55 to 125	9751102QPA TLV2442AM	<a href="#">Samples</a>
TLV2442AQD	ACTIVE	SOIC	D	8	75	RoHS & Green	NIPDAU	Level-1-260C-UNLIM	-40 to 125	V2442A	<a href="#">Samples</a>
TLV2442AQPW	ACTIVE	TSSOP	PW	8	150	RoHS & Green	NIPDAU	Level-1-260C-UNLIM	-40 to 125	2442AQ	<a href="#">Samples</a>
TLV2442AQPWR	ACTIVE	TSSOP	PW	8	2000	RoHS & Green	NIPDAU	Level-1-260C-UNLIM	-40 to 125	2442AQ	<a href="#">Samples</a>
TLV2442CD	ACTIVE	SOIC	D	8	75	RoHS & Green	NIPDAU	Level-1-260C-UNLIM	0 to 70	2442C	<a href="#">Samples</a>
TLV2442CDR	ACTIVE	SOIC	D	8	2500	RoHS & Green	NIPDAU	Level-1-260C-UNLIM	0 to 70	2442C	<a href="#">Samples</a>
TLV2442CPW	ACTIVE	TSSOP	PW	8	150	RoHS & Green	NIPDAU	Level-1-260C-UNLIM	0 to 70	TV2442	<a href="#">Samples</a>
TLV2442ID	ACTIVE	SOIC	D	8	75	RoHS & Green	NIPDAU	Level-1-260C-UNLIM	-40 to 85	2442I	<a href="#">Samples</a>
TLV2442IDR	ACTIVE	SOIC	D	8	2500	RoHS & Green	NIPDAU	Level-1-260C-UNLIM	-40 to 85	2442I	<a href="#">Samples</a>
TLV2442MJGB	ACTIVE	CDIP	JG	8	50	TBD	Call TI	Call TI	-55 to 125	9751101QPA TLV2442M	<a href="#">Samples</a>
TLV2442QPW	ACTIVE	TSSOP	PW	8	150	RoHS & Green	NIPDAU	Level-1-260C-UNLIM	-40 to 125	2442Q	<a href="#">Samples</a>
TLV2442QPWR	ACTIVE	TSSOP	PW	8	2000	RoHS & Green	NIPDAU	Level-1-260C-UNLIM	-40 to 125	2442Q	<a href="#">Samples</a>
TLV2444AID	ACTIVE	SOIC	D	14	50	RoHS & Green	NIPDAU	Level-1-260C-UNLIM	-40 to 125	2444AI	<a href="#">Samples</a>

Orderable Device	Status (1)	Package Type	Package Drawing	Pins	Package Qty	Eco Plan (2)	Lead finish/ Ball material (6)	MSL Peak Temp (3)	Op Temp (°C)	Device Marking (4/5)	Samples
TLV2444AIPW	ACTIVE	TSSOP	PW	14	90	RoHS & Green	NIPDAU	Level-1-260C-UNLIM	-40 to 125	2444AI	<a href="#">Samples</a>
TLV2444AIPWR	ACTIVE	TSSOP	PW	14	2000	RoHS & Green	NIPDAU	Level-1-260C-UNLIM	-40 to 125	2444AI	<a href="#">Samples</a>
TLV2444CD	ACTIVE	SOIC	D	14	50	RoHS & Green	NIPDAU	Level-1-260C-UNLIM	0 to 70	2444C	<a href="#">Samples</a>
TLV2444CDR	ACTIVE	SOIC	D	14	2500	RoHS & Green	NIPDAU	Level-1-260C-UNLIM	0 to 70	2444C	<a href="#">Samples</a>
TLV2444CPW	ACTIVE	TSSOP	PW	14	90	RoHS & Green	NIPDAU	Level-1-260C-UNLIM	0 to 70	2444C	<a href="#">Samples</a>
TLV2444CPWR	ACTIVE	TSSOP	PW	14	2000	RoHS & Green	NIPDAU	Level-1-260C-UNLIM	0 to 70	2444C	<a href="#">Samples</a>
TLV2444ID	ACTIVE	SOIC	D	14	50	RoHS & Green	NIPDAU	Level-1-260C-UNLIM	-40 to 125	2444I	<a href="#">Samples</a>
TLV2444IDR	ACTIVE	SOIC	D	14	2500	RoHS & Green	NIPDAU	Level-1-260C-UNLIM	-40 to 125	2444I	<a href="#">Samples</a>
TLV2444IPWR	ACTIVE	TSSOP	PW	14	2000	RoHS & Green	NIPDAU	Level-1-260C-UNLIM	-40 to 125	2444I	<a href="#">Samples</a>

(1) The marketing status values are defined as follows:

**ACTIVE:** Product device recommended for new designs.

**LIFEBUY:** TI has announced that the device will be discontinued, and a lifetime-buy period is in effect.

**NRND:** Not recommended for new designs. Device is in production to support existing customers, but TI does not recommend using this part in a new design.

**PREVIEW:** Device has been announced but is not in production. Samples may or may not be available.

**OBSOLETE:** TI has discontinued the production of the device.

(2) **RoHS:** TI defines "RoHS" to mean semiconductor products that are compliant with the current EU RoHS requirements for all 10 RoHS substances, including the requirement that RoHS substance do not exceed 0.1% by weight in homogeneous materials. Where designed to be soldered at high temperatures, "RoHS" products are suitable for use in specified lead-free processes. TI may reference these types of products as "Pb-Free".

**RoHS Exempt:** TI defines "RoHS Exempt" to mean products that contain lead but are compliant with EU RoHS pursuant to a specific EU RoHS exemption.

**Green:** TI defines "Green" to mean the content of Chlorine (Cl) and Bromine (Br) based flame retardants meet JS709B low halogen requirements of <=1000ppm threshold. Antimony trioxide based flame retardants must also meet the <=1000ppm threshold requirement.

(3) MSL, Peak Temp. - The Moisture Sensitivity Level rating according to the JEDEC industry standard classifications, and peak solder temperature.

(4) There may be additional marking, which relates to the logo, the lot trace code information, or the environmental category on the device.

(5) Multiple Device Markings will be inside parentheses. Only one Device Marking contained in parentheses and separated by a "~" will appear on a device. If a line is indented then it is a continuation of the previous line and the two combined represent the entire Device Marking for that device.

<sup>(6)</sup> Lead finish/Ball material - Orderable Devices may have multiple material finish options. Finish options are separated by a vertical ruled line. Lead finish/Ball material values may wrap to two lines if the finish value exceeds the maximum column width.

**Important Information and Disclaimer:**The information provided on this page represents TI's knowledge and belief as of the date that it is provided. TI bases its knowledge and belief on information provided by third parties, and makes no representation or warranty as to the accuracy of such information. Efforts are underway to better integrate information from third parties. TI has taken and continues to take reasonable steps to provide representative and accurate information but may not have conducted destructive testing or chemical analysis on incoming materials and chemicals. TI and TI suppliers consider certain information to be proprietary, and thus CAS numbers and other limited information may not be available for release.

In no event shall TI's liability arising out of such information exceed the total purchase price of the TI part(s) at issue in this document sold by TI to Customer on an annual basis.

**OTHER QUALIFIED VERSIONS OF TLV2442, TLV2442A, TLV2442AM, TLV2442M :**

- Catalog : [TLV2442A](#), [TLV2442](#)
- Automotive : [TLV2442-Q1](#), [TLV2442A-Q1](#), [TLV2442A-Q1](#), [TLV2442-Q1](#)
- Military : [TLV2442M](#), [TLV2442AM](#)

NOTE: Qualified Version Definitions:

- Catalog - TI's standard catalog product
- Automotive - Q100 devices qualified for high-reliability automotive applications targeting zero defects
- Military - QML certified for Military and Defense Applications

**TAPE AND REEL INFORMATION**

**QUADRANT ASSIGNMENTS FOR PIN 1 ORIENTATION IN TAPE**

\*All dimensions are nominal

Device	Package Type	Package Drawing	Pins	SPQ	Reel Diameter (mm)	Reel Width W1 (mm)	A0 (mm)	B0 (mm)	K0 (mm)	P1 (mm)	W (mm)	Pin1 Quadrant
TLV2442AIDR	SOIC	D	8	2500	330.0	12.4	6.4	5.2	2.1	8.0	12.0	Q1
TLV2442AIPWR	TSSOP	PW	8	2000	330.0	12.4	7.0	3.6	1.6	8.0	12.0	Q1
TLV2442AQPWR	TSSOP	PW	8	2000	330.0	12.4	7.0	3.6	1.6	8.0	12.0	Q1
TLV2442CDR	SOIC	D	8	2500	330.0	12.4	6.4	5.2	2.1	8.0	12.0	Q1
TLV2442IDR	SOIC	D	8	2500	330.0	12.4	6.4	5.2	2.1	8.0	12.0	Q1
TLV2442QPWR	TSSOP	PW	8	2000	330.0	12.4	7.0	3.6	1.6	8.0	12.0	Q1
TLV2444AIPWR	TSSOP	PW	14	2000	330.0	12.4	6.9	5.6	1.6	8.0	12.0	Q1
TLV2444CDR	SOIC	D	14	2500	330.0	16.4	6.5	9.0	2.1	8.0	16.0	Q1
TLV2444CPWR	TSSOP	PW	14	2000	330.0	12.4	6.9	5.6	1.6	8.0	12.0	Q1
TLV2444IDR	SOIC	D	14	2500	330.0	16.4	6.5	9.0	2.1	8.0	16.0	Q1
TLV2444IPWR	TSSOP	PW	14	2000	330.0	12.4	6.9	5.6	1.6	8.0	12.0	Q1

**TAPE AND REEL BOX DIMENSIONS**

\*All dimensions are nominal

Device	Package Type	Package Drawing	Pins	SPQ	Length (mm)	Width (mm)	Height (mm)
TLV2442AIDR	SOIC	D	8	2500	340.5	338.1	20.6
TLV2442AIPWR	TSSOP	PW	8	2000	356.0	356.0	35.0
TLV2442AQPWR	TSSOP	PW	8	2000	356.0	356.0	35.0
TLV2442CDR	SOIC	D	8	2500	340.5	338.1	20.6
TLV2442IDR	SOIC	D	8	2500	340.5	338.1	20.6
TLV2442QPWR	TSSOP	PW	8	2000	356.0	356.0	35.0
TLV2444AIPWR	TSSOP	PW	14	2000	356.0	356.0	35.0
TLV2444CDR	SOIC	D	14	2500	350.0	350.0	43.0
TLV2444CPWR	TSSOP	PW	14	2000	356.0	356.0	35.0
TLV2444IDR	SOIC	D	14	2500	350.0	350.0	43.0
TLV2444IPWR	TSSOP	PW	14	2000	356.0	356.0	35.0

**TUBE**

\*All dimensions are nominal

Device	Package Name	Package Type	Pins	SPQ	L (mm)	W (mm)	T (μm)	B (mm)
TLV2442AID	D	SOIC	8	75	507	8	3940	4.32
TLV2442AID	D	SOIC	8	75	505.46	6.76	3810	4
TLV2442AIPW	PW	TSSOP	8	150	530	10.2	3600	3.5
TLV2442AQD	D	SOIC	8	75	507	8	3940	4.32
TLV2442AQPW	PW	TSSOP	8	150	530	10.2	3600	3.5
TLV2442CD	D	SOIC	8	75	505.46	6.76	3810	4
TLV2442CD	D	SOIC	8	75	507	8	3940	4.32
TLV2442CPW	PW	TSSOP	8	150	530	10.2	3600	3.5
TLV2442ID	D	SOIC	8	75	505.46	6.76	3810	4
TLV2442ID	D	SOIC	8	75	507	8	3940	4.32
TLV2442QPW	PW	TSSOP	8	150	530	10.2	3600	3.5
TLV2444AID	D	SOIC	14	50	505.46	6.76	3810	4
TLV2444AIPW	PW	TSSOP	14	90	530	10.2	3600	3.5
TLV2444CD	D	SOIC	14	50	505.46	6.76	3810	4
TLV2444CPW	PW	TSSOP	14	90	530	10.2	3600	3.5
TLV2444ID	D	SOIC	14	50	505.46	6.76	3810	4

D (R-PDSO-G14)

PLASTIC SMALL OUTLINE



- NOTES:
- A. All linear dimensions are in inches (millimeters).
  - B. This drawing is subject to change without notice.
  - $\triangle C$  Body length does not include mold flash, protrusions, or gate burrs. Mold flash, protrusions, or gate burrs shall not exceed 0.006 (0,15) each side.
  - $\triangle D$  Body width does not include interlead flash. Interlead flash shall not exceed 0.017 (0,43) each side.
  - E. Reference JEDEC MS-012 variation AB.

D (R-PDSO-G14)

PLASTIC SMALL OUTLINE



4211283-3/E 08/12

- NOTES:
- A. All linear dimensions are in millimeters.
  - B. This drawing is subject to change without notice.
  - C. Publication IPC-7351 is recommended for alternate designs.
  - D. Laser cutting apertures with trapezoidal walls and also rounding corners will offer better paste release. Customers should contact their board assembly site for stencil design recommendations. Refer to IPC-7525 for other stencil recommendations.
  - E. Customers should contact their board fabrication site for solder mask tolerances between and around signal pads.

PW (R-PDSO-G14)

PLASTIC SMALL OUTLINE



- NOTES:
- A. All linear dimensions are in millimeters. Dimensioning and tolerancing per ASME Y14.5M-1994.
  - B. This drawing is subject to change without notice.
  - C. Body length does not include mold flash, protrusions, or gate burrs. Mold flash, protrusions, or gate burrs shall not exceed 0,15 each side.
  - D. Body width does not include interlead flash. Interlead flash shall not exceed 0,25 each side.
  - E. Falls within JEDEC MO-153

PW (R-PDSO-G14)

PLASTIC SMALL OUTLINE



- NOTES:
- All linear dimensions are in millimeters.
  - This drawing is subject to change without notice.
  - Publication IPC-7351 is recommended for alternate designs.
  - Laser cutting apertures with trapezoidal walls and also rounding corners will offer better paste release. Customers should contact their board assembly site for stencil design recommendations. Refer to IPC-7525 for other stencil recommendations.
  - Customers should contact their board fabrication site for solder mask tolerances between and around signal pads.



D0008A

# PACKAGE OUTLINE

SOIC - 1.75 mm max height

SMALL OUTLINE INTEGRATED CIRCUIT



4214825/C 02/2019

NOTES:

1. Linear dimensions are in inches [millimeters]. Dimensions in parenthesis are for reference only. Controlling dimensions are in inches. Dimensioning and tolerancing per ASME Y14.5M.
2. This drawing is subject to change without notice.
3. This dimension does not include mold flash, protrusions, or gate burrs. Mold flash, protrusions, or gate burrs shall not exceed  $.006$  [0.15] per side.
4. This dimension does not include interlead flash.
5. Reference JEDEC registration MS-012, variation AA.

# EXAMPLE BOARD LAYOUT

D0008A

SOIC - 1.75 mm max height

SMALL OUTLINE INTEGRATED CIRCUIT



LAND PATTERN EXAMPLE  
 EXPOSED METAL SHOWN  
 SCALE:8X



SOLDER MASK DETAILS

4214825/C 02/2019

NOTES: (continued)

- 6. Publication IPC-7351 may have alternate designs.
- 7. Solder mask tolerances between and around signal pads can vary based on board fabrication site.

# EXAMPLE STENCIL DESIGN

D0008A

SOIC - 1.75 mm max height

SMALL OUTLINE INTEGRATED CIRCUIT



SOLDER PASTE EXAMPLE  
BASED ON .005 INCH [0.125 MM] THICK STENCIL  
SCALE:8X

4214825/C 02/2019

NOTES: (continued)

8. Laser cutting apertures with trapezoidal walls and rounded corners may offer better paste release. IPC-7525 may have alternate design recommendations.
9. Board assembly site may have different recommendations for stencil design.

PW0008A



PACKAGE OUTLINE

TSSOP - 1.2 mm max height

SMALL OUTLINE PACKAGE

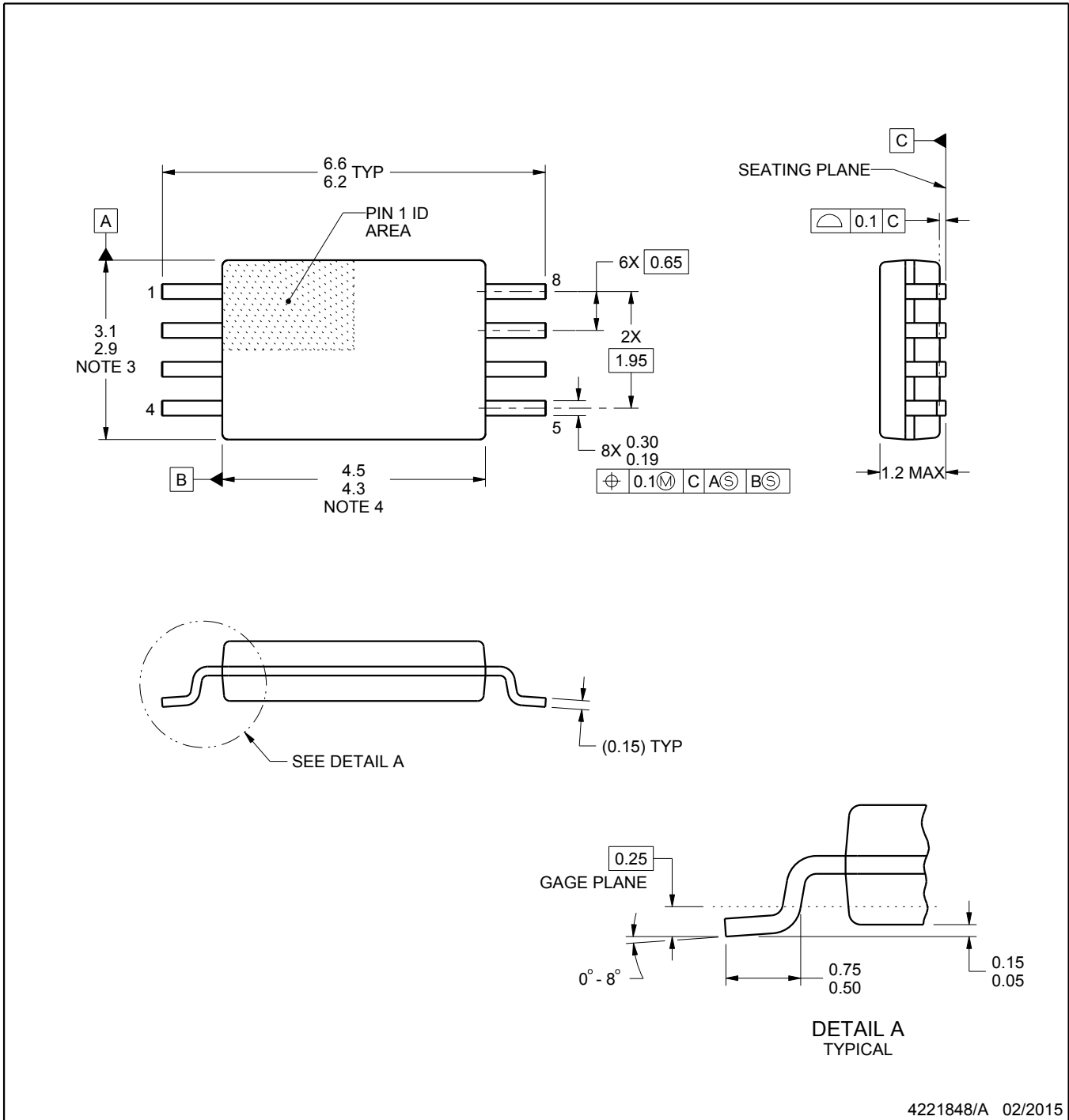

4221848/A 02/2015

NOTES:

1. All linear dimensions are in millimeters. Any dimensions in parenthesis are for reference only. Dimensioning and tolerancing per ASME Y14.5M.
2. This drawing is subject to change without notice.
3. This dimension does not include mold flash, protrusions, or gate burrs. Mold flash, protrusions, or gate burrs shall not exceed 0.15 mm per side.
4. This dimension does not include interlead flash. Interlead flash shall not exceed 0.25 mm per side.
5. Reference JEDEC registration MO-153, variation AA.

# EXAMPLE BOARD LAYOUT

PW0008A

TSSOP - 1.2 mm max height

SMALL OUTLINE PACKAGE



LAND PATTERN EXAMPLE  
SCALE:10X



SOLDER MASK DETAILS  
NOT TO SCALE

4221848/A 02/2015

NOTES: (continued)

- 6. Publication IPC-7351 may have alternate designs.
- 7. Solder mask tolerances between and around signal pads can vary based on board fabrication site.

# EXAMPLE STENCIL DESIGN

PW0008A

TSSOP - 1.2 mm max height

SMALL OUTLINE PACKAGE



SOLDER PASTE EXAMPLE  
BASED ON 0.125 mm THICK STENCIL  
SCALE:10X

4221848/A 02/2015

NOTES: (continued)

8. Laser cutting apertures with trapezoidal walls and rounded corners may offer better paste release. IPC-7525 may have alternate design recommendations.
9. Board assembly site may have different recommendations for stencil design.

# PACKAGE OUTLINE

## JG0008A

### CDIP - 5.08 mm max height

CERAMIC DUAL IN-LINE PACKAGE

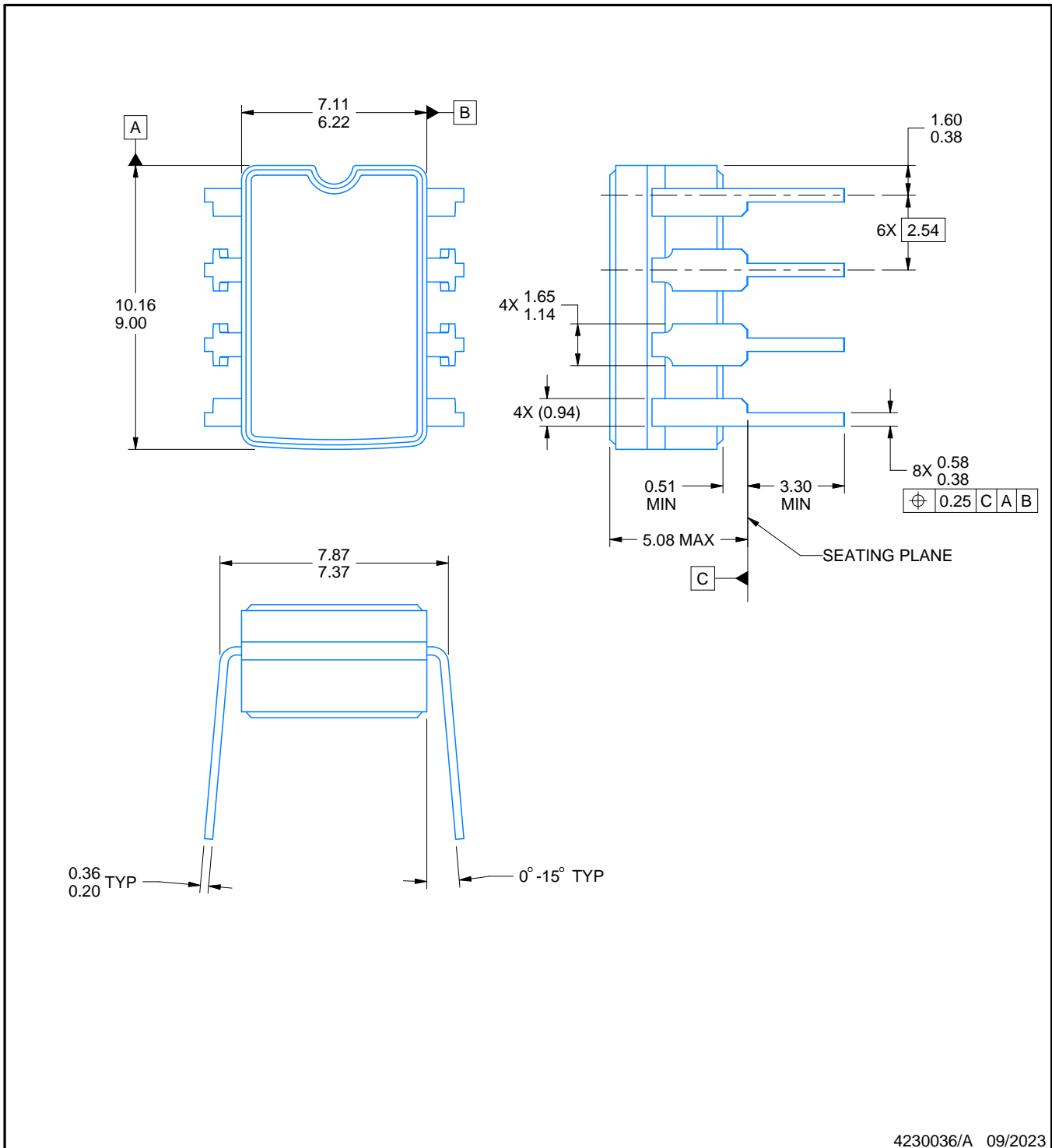

4230036/A 09/2023

#### NOTES:

1. All linear dimensions are in millimeters. Any dimensions in parenthesis are for reference only. Dimensioning and tolerancing per ASME Y14.5M.
2. This drawing is subject to change without notice.
3. This package can be hermetically sealed with a ceramic lid using glass frit.
4. Index point is provided on cap for terminal identification.
5. Falls within MIL STD 1835 GDIP1-T8

# EXAMPLE BOARD LAYOUT

JG0008A

CDIP - 5.08 mm max height

CERAMIC DUAL IN-LINE PACKAGE

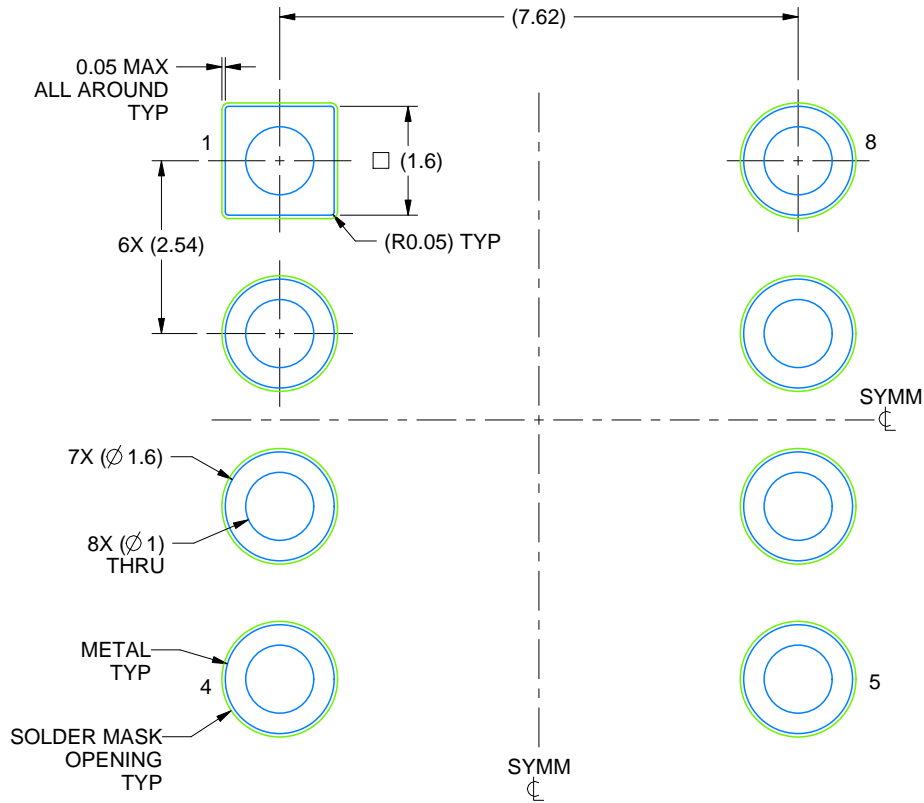

LAND PATTERN EXAMPLE  
NON SOLDER MASK DEFINED  
SCALE: 9X

4230036/A 09/2023

## IMPORTANT NOTICE AND DISCLAIMER

TI PROVIDES TECHNICAL AND RELIABILITY DATA (INCLUDING DATA SHEETS), DESIGN RESOURCES (INCLUDING REFERENCE DESIGNS), APPLICATION OR OTHER DESIGN ADVICE, WEB TOOLS, SAFETY INFORMATION, AND OTHER RESOURCES "AS IS" AND WITH ALL FAULTS, AND DISCLAIMS ALL WARRANTIES, EXPRESS AND IMPLIED, INCLUDING WITHOUT LIMITATION ANY IMPLIED WARRANTIES OF MERCHANTABILITY, FITNESS FOR A PARTICULAR PURPOSE OR NON-INFRINGEMENT OF THIRD PARTY INTELLECTUAL PROPERTY RIGHTS.

These resources are intended for skilled developers designing with TI products. You are solely responsible for (1) selecting the appropriate TI products for your application, (2) designing, validating and testing your application, and (3) ensuring your application meets applicable standards, and any other safety, security, regulatory or other requirements.

These resources are subject to change without notice. TI grants you permission to use these resources only for development of an application that uses the TI products described in the resource. Other reproduction and display of these resources is prohibited. No license is granted to any other TI intellectual property right or to any third party intellectual property right. TI disclaims responsibility for, and you will fully indemnify TI and its representatives against, any claims, damages, costs, losses, and liabilities arising out of your use of these resources.

TI's products are provided subject to [TI's Terms of Sale](#) or other applicable terms available either on [ti.com](https://www.ti.com) or provided in conjunction with such TI products. TI's provision of these resources does not expand or otherwise alter TI's applicable warranties or warranty disclaimers for TI products.

TI objects to and rejects any additional or different terms you may have proposed.

Mailing Address: Texas Instruments, Post Office Box 655303, Dallas, Texas 75265  
Copyright © 2024, Texas Instruments Incorporated

## Looking for pricing, stock, or lifecycle information?

Click below to explore more details on WIN SOURCE:

 [View TLV2444CDR on WIN SOURCE](#)

 [Texas Instruments](#) Information

## Optimize Your Supply Chain with WIN SOURCE Solutions

-  Global Sourcing Solution
-  Obsolete Management
-  Cost Control Management
-  Shortage Management
-  Alternative Solution
-  Excess Inventory Management