



**THE DATASHEET OF  
TLV2711IDBVR**



TLV2711, TLV2711Y  
Advanced LinCMOS™ RAIL-TO-RAIL  
MICROPOWER SINGLE OPERATIONAL AMPLIFIERS

SLOS196A – AUGUST 1997 – REVISED MARCH 2001

- Output Swing Includes Both Supply Rails
- Low Noise . . . 21 nV/√Hz Typ at f = 1 kHz
- Low Input Bias Current . . . 1 pA Typ
- Very Low Power . . . 11 μA Per Channel Typ
- Common-Mode Input Voltage Range Includes Negative Rail
- Wide Supply Voltage Range 2.7 V to 10 V
- Available in the SOT-23 Package
- Macromodel Included

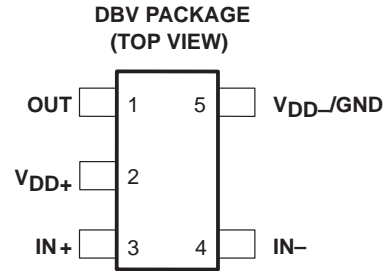

**description**

The TLV2711 is a single low-voltage operational amplifier available in the SOT-23 package. It consumes only 11 μA (typ) of supply current and is ideal for battery-power applications. Looking at Figure 1, the TLV2711 has a 3-V noise level of 21 nV/√Hz at 1 kHz; five times lower than competitive SOT-23 micropower solutions. The device exhibits rail-to-rail output performance for increased dynamic range in single- or split-supply applications. The TLV2711 is fully characterized at 3 V and 5 V and is optimized for low-voltage applications.

The TLV2711, exhibiting high input impedance and low noise, is excellent for small-signal conditioning for high-impedance sources, such as piezoelectric transducers. Because of the micropower dissipation levels combined with 3-V operation, these devices work well in hand-held monitoring and remote-sensing applications. In addition, the rail-to-rail output feature with single or split supplies makes this family a great choice when interfacing with analog-to-digital converters (ADCs).

With a total area of 5.6mm<sup>2</sup>, the SOT-23 package only requires one-third the board space of the standard 8-pin SOIC package. This ultra-small package allows designers to place single amplifiers very close to the signal source, minimizing noise pick-up from long PCB traces.

**EQUIVALENT INPUT NOISE VOLTAGE†  
VS  
FREQUENCY**

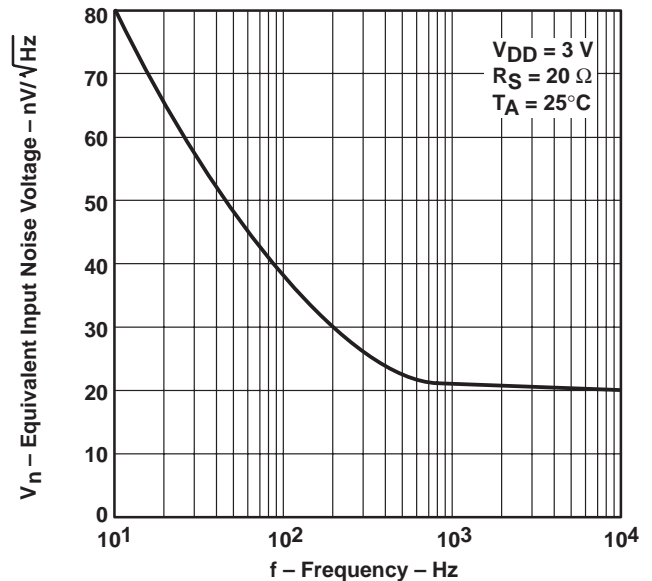

† For all curves where V<sub>DD</sub> = 5 V, all loads are referenced to 2.5 V.  
For all curves where V<sub>DD</sub> = 3 V, all loads are referenced to 1.5 V.

**Figure 1. Equivalent Input Noise Voltage Versus Frequency**

**AVAILABLE OPTIONS**

T <sub>A</sub>	V <sub>IOMax</sub> AT 25°C	PACKAGED DEVICES	SYMBOL	CHIP FORM‡ (Y)
		SOT-23 (DBV)†		
0°C to 70°C	3 mV	TLV2711CDBV	VAJC	TLV2711Y
-40°C to 85°C	3 mV	TLV2711IDBV	VAJI	

† The DBV package available in tape and reel only.

‡ Chip forms are tested at T<sub>A</sub> = 25°C only.



Please be aware that an important notice concerning availability, standard warranty, and use in critical applications of Texas Instruments semiconductor products and disclaimers thereto appears at the end of this data sheet.

Advanced LinCMOS is a trademark of Texas Instruments.

PRODUCTION DATA information is current as of publication date. Products conform to specifications per the terms of Texas Instruments standard warranty. Production processing does not necessarily include testing of all parameters.



POST OFFICE BOX 655303 • DALLAS, TEXAS 75265

Copyright © 2001, Texas Instruments Incorporated

**TLV2711, TLV2711Y**  
**Advanced LinCMOS™ RAIL-TO-RAIL**  
**MICROPOWER SINGLE OPERATIONAL AMPLIFIERS**

SLOS196A – AUGUST 1997 – REVISED MARCH 2001

**TLV2711Y chip information**

This chip, when properly assembled, displays characteristics similar to the TLV2711C. Thermal compression or ultrasonic bonding may be used on the doped-aluminum bonding pads. This chip may be mounted with conductive epoxy or a gold-silicon preform.

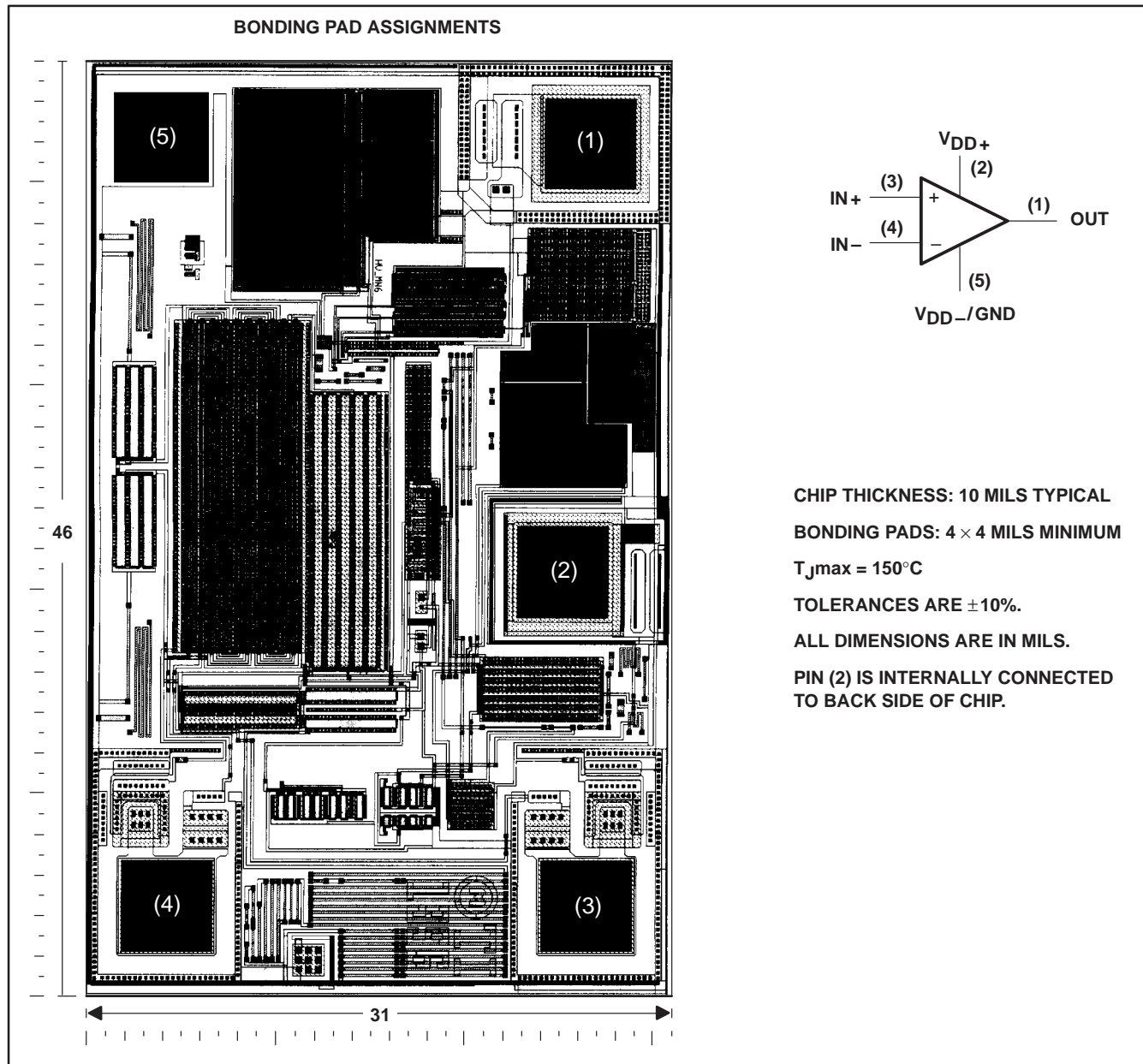

equivalent schematic

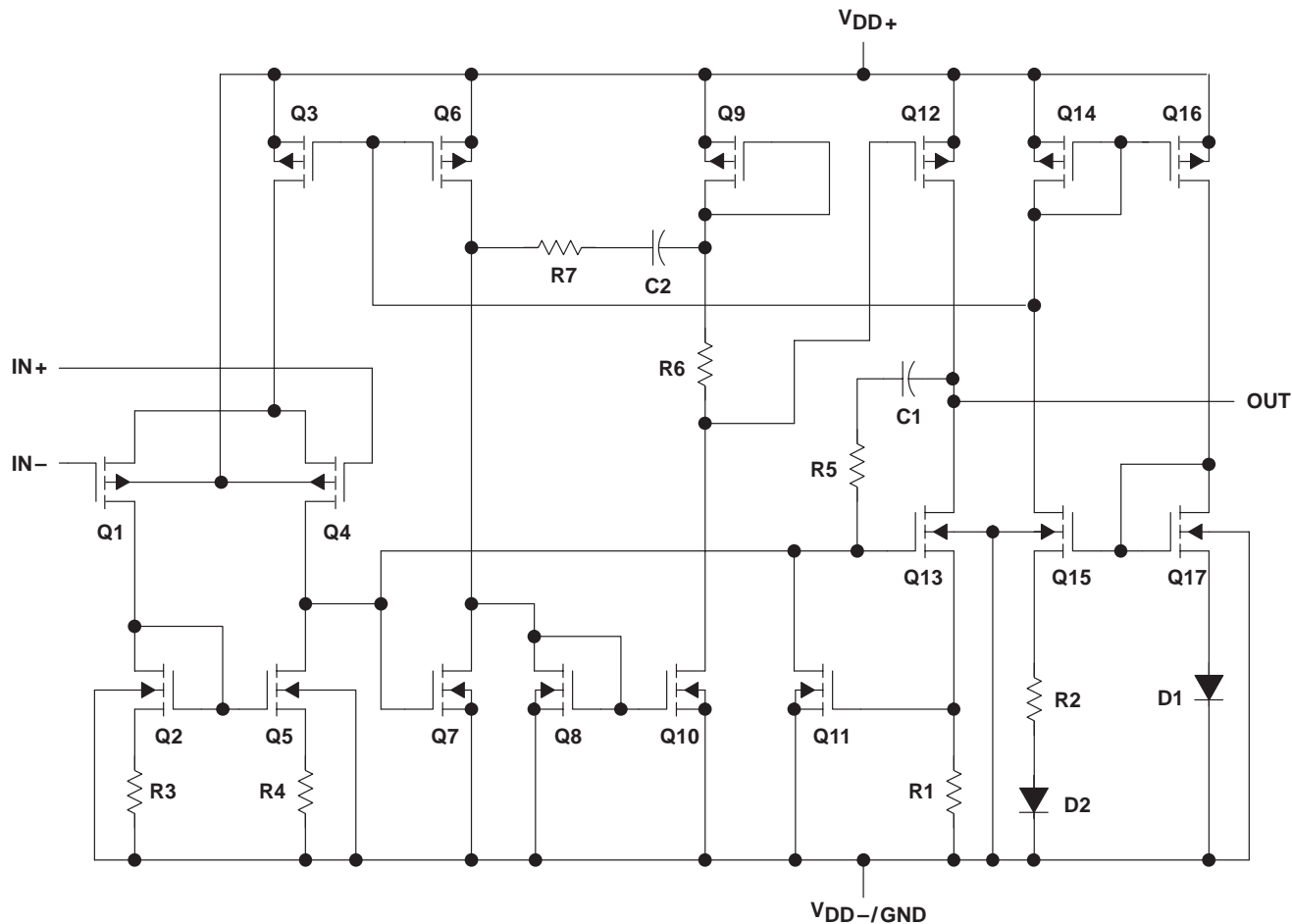

COMPONENT COUNT†	
Transistors	23
Diodes	6
Resistors	11
Capacitors	2

† Includes both amplifiers and all ESD, bias, and trim circuitry

**TLV2711, TLV2711Y**  
**Advanced LinCMOS™ RAIL-TO-RAIL**  
**MICROPOWER SINGLE OPERATIONAL AMPLIFIERS**

SLOS196A – AUGUST 1997 – REVISED MARCH 2001

**absolute maximum ratings over operating free-air temperature range (unless otherwise noted)†**

Supply voltage, $V_{DD}$ (see Note 1)	12 V
Differential input voltage, $V_{ID}$ (see Note 2)	$\pm V_{DD}$
Input voltage range, $V_I$ (any input, see Note 1)	-0.3 V to $V_{DD}$
Input current, $I_I$ (each input)	$\pm 5$ mA
Output current, $I_O$	$\pm 50$ mA
Total current into $V_{DD+}$	$\pm 50$ mA
Total current out of $V_{DD-}$	$\pm 50$ mA
Duration of short-circuit current (at or below) 25°C (see Note 3)	unlimited
Continuous total power dissipation	See Dissipation Rating Table
Operating free-air temperature range, $T_A$ : TLV2711C	0°C to 70°C
TLV2711I	-40°C to 85°C
Storage temperature range, $T_{stg}$	-65°C to 150°C
Lead temperature 1,6 mm (1/16 inch) from case for 10 seconds: DBV package	260°C

† Stresses beyond those listed under “absolute maximum ratings” may cause permanent damage to the device. These are stress ratings only, and functional operation of the device at these or any other conditions beyond those indicated under “recommended operating conditions” is not implied. Exposure to absolute-maximum-rated conditions for extended periods may affect device reliability.

- NOTES:
1. All voltage values, except differential voltages, are with respect to  $V_{DD-}$ .
  2. Differential voltages are at the noninverting input with respect to the inverting input. Excessive current flows when input is brought below  $V_{DD-} - 0.3$  V.
  3. The output may be shorted to either supply. Temperature and/or supply voltages must be limited to ensure that the maximum dissipation rating is not exceeded.

**DISSIPATION RATING TABLE**

PACKAGE	$T_A \leq 25^\circ\text{C}$ POWER RATING	DERATING FACTOR ABOVE $T_A = 25^\circ\text{C}$	$T_A = 70^\circ\text{C}$ POWER RATING	$T_A = 85^\circ\text{C}$ POWER RATING
DBV	150 mW	1.2 mW/°C	96 mW	78 mW

**recommended operating conditions**

	TLV2711C		TLV2711I		UNIT
	MIN	MAX	MIN	MAX	
Supply voltage, $V_{DD}$ (see Note 1)	2.7	10	2.7	10	V
Input voltage range, $V_I$	$V_{DD-}$	$V_{DD+} - 1.3$	$V_{DD-}$	$V_{DD+} - 1.3$	V
Common-mode input voltage, $V_{IC}$	$V_{DD-}$	$V_{DD+} - 1.3$	$V_{DD-}$	$V_{DD+} - 1.3$	V
Operating free-air temperature, $T_A$	0	70	-40	85	°C

NOTE 1: All voltage values, except differential voltages, are with respect to  $V_{DD-}$ .



**electrical characteristics at specified free-air temperature,  $V_{DD} = 3\text{ V}$  (unless otherwise noted)**

PARAMETER	TEST CONDITIONS	$T_A$ †	TLV2711C			TLV2711I			UNIT	
			MIN	TYP	MAX	MIN	TYP	MAX		
$V_{IO}$ Input offset voltage	$V_{DD\pm} = \pm 1.5\text{ V}$ , $V_O = 0$ , $V_{IC} = 0$ , $R_S = 50\ \Omega$	Full range	0.4		3	0.4		3	mV	
$\alpha_{V_{IO}}$ Temperature coefficient of input offset voltage			1			1			$\mu\text{V}/^\circ\text{C}$	
Input offset voltage long-term drift (see Note 4)		25°C	0.003			0.003			$\mu\text{V}/\text{mo}$	
$I_{IO}$ Input offset current		25°C	0.5		60	0.5		60	pA	
$I_{IB}$ Input bias current		Full range	150			150				
$V_{ICR}$ Common-mode input voltage range	$ V_{IO}  \leq 5\text{ mV}$ , $R_S = 50\ \Omega$	25°C	0 to 2	-0.3 to 2.2	0 to 2	-0.3 to 2.2	V			
		Full range	0 to 1.7		0 to 1.7					
$V_{OH}$ High-level output voltage	$I_{OH} = -100\ \mu\text{A}$	25°C	2.94			2.94			V	
	$I_{OH} = -250\ \mu\text{A}$	25°C	2.85			2.85				
		Full range	2.6			2.6				
$V_{OL}$ Low-level output voltage	$V_{IC} = 1.5\text{ V}$ , $I_{OL} = 50\ \mu\text{A}$	25°C	15			15			mV	
	$V_{IC} = 1.5\text{ V}$ , $I_{OL} = 500\ \mu\text{A}$	25°C	150			150				
		Full range	500			500				
$A_{VD}$ Large-signal differential voltage amplification	$V_{IC} = 1.5\text{ V}$ , $V_O = 1\text{ V to }2\text{ V}$	$R_L = 10\ \text{k}\Omega$ ‡	25°C	3	7	3	7	V/mV		
			Full range	1			1			
		$R_L = 1\ \text{M}\Omega$ ‡	25°C	600			600			
$r_{i(d)}$ Differential input resistance		25°C	$10^{12}$			$10^{12}$			$\Omega$	
$r_{i(c)}$ Common-mode input resistance		25°C	$10^{12}$			$10^{12}$			$\Omega$	
$c_{i(c)}$ Common-mode input capacitance	$f = 10\ \text{kHz}$ ,	25°C	5			5			pF	
$z_o$ Closed-loop output impedance	$f = 7\ \text{kHz}$ , $A_V = 1$	25°C	200			200			$\Omega$	
CMRR Common-mode rejection ratio	$V_{IC} = 0\text{ to }1.7\text{ V}$ , $R_S = 50\ \Omega$ , $V_O = 1.5\text{ V}$	25°C	65	83	65	83	dB			
		Full range	60			60				
$k_{SVR}$ Supply voltage rejection ratio ( $\Delta V_{DD} / \Delta V_{IO}$ )	$V_{DD} = 2.7\text{ V to }8\text{ V}$ , No load, $V_{IC} = V_{DD}/2$	25°C	80	95	80	95	dB			
		Full range	80			80				
$I_{DD}$ Supply current	$V_O = 1.5\text{ V}$ , No load	25°C	11		25	11		25	$\mu\text{A}$	
		Full range	30			30				

† Full range for the TLV2711C is 0°C to 70°C. Full range for the TLV2711I is -40°C to 85°C.

‡ Referenced to 1.5 V

NOTE 4: Typical values are based on the input offset voltage shift observed through 500 hours of operating life test at  $T_A = 150^\circ\text{C}$  extrapolated to  $T_A = 25^\circ\text{C}$  using the Arrhenius equation and assuming an activation energy of 0.96 eV.

**TLV2711, TLV2711Y**  
**Advanced LinCMOS™ RAIL-TO-RAIL**  
**MICROPOWER SINGLE OPERATIONAL AMPLIFIERS**

SLOS196A – AUGUST 1997 – REVISED MARCH 2001

**operating characteristics at specified free-air temperature,  $V_{DD} = 3\text{ V}$  (unless otherwise noted)**

PARAMETER	TEST CONDITIONS	$T_A$ †	TLV2711C			TLV2711I			UNIT	
			MIN	TYP	MAX	MIN	TYP	MAX		
SR	Slew rate at unity gain $V_O = 1.1\text{ V to }1.9\text{ V}$ , $R_L = 10\text{ k}\Omega$ ‡, $C_L = 100\text{ pF}$ ‡	25°C	0.01	0.025		0.01	0.025		V/ $\mu$ s	
		Full range	0.005			0.005				
$V_n$	Equivalent input noise voltage	f = 10 Hz	80			80			nV/ $\sqrt{\text{Hz}}$	
		f = 1 kHz	22			22				
$V_{N(PP)}$	Peak-to-peak equivalent input noise voltage	f = 0.1 Hz to 1 Hz	660			660			nV	
		f = 0.1 Hz to 10 Hz	880			880				
$I_n$	Equivalent input noise current	25°C	0.6			0.6			fA/ $\sqrt{\text{Hz}}$	
	Gain-bandwidth product	f = 10 kHz, $C_L = 100\text{ pF}$ ‡, $R_L = 10\text{ k}\Omega$ ‡,	25°C	56			56			kHz
BOM	Maximum output-swing bandwidth	$V_{O(PP)} = 1\text{ V}$ , $R_L = 10\text{ k}\Omega$ ‡, $A_V = 1$ , $C_L = 100\text{ pF}$ ‡	25°C	7			7			kHz
$\phi_m$	Phase margin at unity gain	$R_L = 10\text{ k}\Omega$ ‡, $C_L = 100\text{ pF}$ ‡	25°C	56°			56°			
	Gain margin		25°C	20			20			dB

† Full range is  $-40^\circ\text{C}$  to  $85^\circ\text{C}$ .

‡ Referenced to 1.5 V



TLV2711, TLV2711Y  
Advanced LinCMOS™ RAIL-TO-RAIL  
MICROPOWER SINGLE OPERATIONAL AMPLIFIERS  
SLOS196A – AUGUST 1997 – REVISED MARCH 2001

electrical characteristics at specified free-air temperature,  $V_{DD} = 5\text{ V}$  (unless otherwise noted)

PARAMETER	TEST CONDITIONS	$T_A$ †	TLV2711C			TLV2711I			UNIT
			MIN	TYP	MAX	MIN	TYP	MAX	
$V_{IO}$ Input offset voltage	$V_{DD\pm} = \pm 2.5\text{ V}$ , $V_O = 0$ , $V_{IC} = 0$ , $R_S = 50\ \Omega$	Full range	0.45		3	0.45		3	mV
$\alpha_{V_{IO}}$ Temperature coefficient of input offset voltage			0.5			0.5			$\mu\text{V}/^\circ\text{C}$
Input offset voltage long-term drift (see Note 4)		25°C	0.003		0.003		$\mu\text{V}/\text{mo}$		
$I_{IO}$ Input offset current		25°C	0.5		60		pA		
		Full range	150			150			
$I_{IB}$ Input bias current	25°C	1		60		pA			
	Full range	150			150				
$V_{ICR}$ Common-mode input voltage range	$ V_{IO}  \leq 5\text{ mV}$ $R_S = 50\ \Omega$	25°C	0 to 4	-0.3 to 4.2	0 to 4	-0.3 to 4.2	V		
		Full range	0 to 3.5		0 to 3.5				
$V_{OH}$ High-level output voltage	$I_{OH} = -100\ \mu\text{A}$ $I_{OH} = -250\ \mu\text{A}$	25°C	4.95		4.95		V		
		25°C	4.875		4.875				
		Full range	4.6			4.6			
$V_{OL}$ Low-level output voltage	$V_{IC} = 2.5\text{ V}$ , $I_{OL} = 50\ \mu\text{A}$ $V_{IC} = 2.5\text{ V}$ , $I_{OL} = 500\ \mu\text{A}$	25°C	12		12		mV		
		25°C	120		120				
		Full range	500			500			
$A_{VD}$ Large-signal differential voltage amplification	$V_{IC} = 2.5\text{ V}$ , $V_O = 1\text{ V to }4\text{ V}$	25°C	$R_L = 10\ \text{k}\Omega$ ‡		6 12		V/mV		
			Full range		3				
		25°C	$R_L = 1\ \text{M}\Omega$ ‡		800		800		
$r_{i(d)}$ Differential input resistance		25°C	10 <sup>12</sup>		10 <sup>12</sup>		$\Omega$		
$r_{i(c)}$ Common-mode input resistance		25°C	10 <sup>12</sup>		10 <sup>12</sup>		$\Omega$		
$c_{i(c)}$ Common-mode input capacitance	$f = 10\ \text{kHz}$ ,	25°C	5		5		pF		
$z_o$ Closed-loop output impedance	$f = 7\ \text{kHz}$ , $A_V = 1$	25°C	200		200		$\Omega$		
CMRR Common-mode rejection ratio	$V_{IC} = 0\text{ to }2.7\text{ V}$ , $R_S = 50\ \Omega$ , $V_O = 2.5\text{ V}$	25°C	70 83		70 83		dB		
		Full range	70			70			
$k_{SVR}$ Supply voltage rejection ratio ( $\Delta V_{DD} / \Delta V_{IO}$ )	$V_{DD} = 4.4\text{ V to }8\text{ V}$ , No load, $V_{IC} = V_{DD}/2$	25°C	80 95		80 95		dB		
		Full range	80			80			
$I_{DD}$ Supply current	$V_O = 2.5\text{ V}$ , No load	25°C	13 25		13 25		$\mu\text{A}$		
		Full range	30			30			

† Full range for the TLV2711C is 0°C to 70°C. Full range for the TLV2711I is -40°C to 85°C.

‡ Referenced to 1.5 V

NOTE 5: Typical values are based on the input offset voltage shift observed through 500 hours of operating life test at  $T_A = 150^\circ\text{C}$  extrapolated to  $T_A = 25^\circ\text{C}$  using the Arrhenius equation and assuming an activation energy of 0.96 eV.

**TLV2711, TLV2711Y**  
**Advanced LinCMOS™ RAIL-TO-RAIL**  
**MICROPOWER SINGLE OPERATIONAL AMPLIFIERS**

SLOS196A – AUGUST 1997 – REVISED MARCH 2001

**operating characteristics at specified free-air temperature,  $V_{DD} = 5\text{ V}$  (unless otherwise noted)**

PARAMETER	TEST CONDITIONS	$T_A$ †	TLV2711C			TLV2711I			UNIT
			MIN	TYP	MAX	MIN	TYP	MAX	
SR	Slew rate at unity gain $V_O = 1.5\text{ V to }3.5\text{ V}, R_L = 10\text{ k}\Omega^\ddagger,$ $C_L = 100\text{ pF}^\ddagger$	25°C	0.01	0.025		0.01	0.025		V/ $\mu\text{s}$
		Full range	0.005			0.005			
$V_n$	Equivalent input noise voltage	f = 10 Hz	72			72			nV/ $\sqrt{\text{Hz}}$
		f = 1 kHz	21			21			
$V_{N(PP)}$	Peak-to-peak equivalent input noise voltage	f = 0.1 Hz to 1 Hz	600			600			nV
		f = 0.1 Hz to 10 Hz	800			800			
$I_n$	Equivalent input noise current	25°C	0.6			0.6			fA/ $\sqrt{\text{Hz}}$
	Gain-bandwidth product	f = 10 kHz, $R_L = 10\text{ k}\Omega^\ddagger,$ $C_L = 100\text{ pF}^\ddagger$	65			65			kHz
$B_{OM}$	Maximum output-swing bandwidth	$V_{O(PP)} = 2\text{ V},$ $R_L = 10\text{ k}\Omega^\ddagger,$ $A_V = 1,$ $C_L = 100\text{ pF}^\ddagger$	7			7			kHz
$\phi_m$	Phase margin at unity gain	$R_L = 10\text{ k}\Omega^\ddagger,$ $C_L = 100\text{ pF}^\ddagger$	60°			60°			dB
		Gain margin	22			22			

† Full range is  $-40^\circ\text{C}$  to  $85^\circ\text{C}$ .

‡ Referenced to 1.5 V

**electrical characteristics at  $V_{DD} = 3\text{ V}, T_A = 25^\circ\text{C}$  (unless otherwise noted)**

PARAMETER	TEST CONDITIONS	TLV2711Y			UNIT	
		MIN	TYP	MAX		
$V_{IO}$	Input offset voltage	0.47			mV	
$I_{IO}$	Input offset current	0.5			pA	
$I_{IB}$	Input bias current	1			pA	
$V_{ICR}$	Common-mode input voltage range	$ V_{IO}  \leq 5\text{ mV},$ $R_S = 50\ \Omega$	-0.3 to 2.2		V	
$V_{OH}$	High-level output voltage	$I_{OH} = -100\ \mu\text{A}$			2.94	
		$I_{OH} = -200\ \mu\text{A}$			2.85	
$V_{OL}$	Low-level output voltage	$V_{IC} = 0,$ $I_{OL} = 50\ \mu\text{A}$	15		mV	
		$V_{IC} = 0,$ $I_{OL} = 500\ \mu\text{A}$	150			
$A_{VD}$	Large-signal differential voltage amplification	$V_{IC} = 1.5\text{ V},$ $V_O = 1\text{ V to }2\text{ V}$	$R_L = 10\text{ k}\Omega^\ddagger$	7		V/mV
			$R_L = 1\text{ M}\Omega^\ddagger$	600		
$r_{i(d)}$	Differential input resistance				$10^{12}$	
$r_{i(c)}$	Common-mode input resistance				$10^{12}$	
$c_{i(c)}$	Common-mode input capacitance	f = 10 kHz			5	
$z_o$	Closed-loop output impedance	f = 7 kHz, $A_V = 1$			200	
CMRR	Common-mode rejection ratio	$V_{IC} = 0\text{ to }1.7\text{ V},$ $V_O = 1.5\text{ V},$ $R_S = 50\ \Omega$	83		dB	
$k_{SVR}$	Supply voltage rejection ratio ( $\Delta V_{DD}/\Delta V_{IO}$ )	$V_{DD} = 2.7\text{ V to }8\text{ V},$ $V_{IC} = V_{DD}/2,$ No load	95		dB	
$I_{DD}$	Supply current	$V_O = 1.5\text{ V},$ No load	11		$\mu\text{A}$	

† Referenced to 1.5 V



**electrical characteristics at  $V_{DD} = 5\text{ V}$ ,  $T_A = 25^\circ\text{C}$  (unless otherwise noted)**

PARAMETER		TEST CONDITIONS		TLV2711Y			UNIT	
				MIN	TYP	MAX		
$V_{IO}$	Input offset voltage	$V_{DD} \pm \pm 2.5\text{ V}$ , $R_S = 50\ \Omega$		$V_{IC} = 0$ , $V_O = 0$		0.45		mV
$I_{IO}$	Input offset current					0.5		pA
$I_{IB}$	Input bias current					1		pA
$V_{ICR}$	Common-mode input voltage range	$ V_{IO}  \leq 5\text{ mV}$ ,	$R_S = 50\ \Omega$	-0.3 to 4.2		V		
$V_{OH}$	High-level output voltage	$I_{OH} = -100\ \mu\text{A}$		4.95		V		
		$I_{OH} = -250\ \mu\text{A}$		4.875				
$V_{OL}$	Low-level output voltage	$V_{IC} = 2.5\text{ V}$ ,	$I_{OL} = 50\ \mu\text{A}$	12		mV		
		$V_{IC} = 2.5\text{ V}$ ,	$I_{OL} = 500\ \mu\text{A}$	120				
$A_{VD}$	Large-signal differential voltage amplification	$V_{IC} = 2.5\text{ V}$ ,	$V_O = 1\text{ V to }4\text{ V}$	$R_L = 10\text{ k}\Omega^\dagger$	12		V/mV	
				$R_L = 1\text{ M}\Omega^\dagger$	800			
$r_{i(d)}$	Differential input resistance			$10^{12}$		$\Omega$		
$r_{i(c)}$	Common-mode input resistance			$10^{12}$		$\Omega$		
$c_{i(c)}$	Common-mode input capacitance	$f = 10\text{ kHz}$		5		pF		
$z_o$	Closed-loop output impedance	$f = 7\text{ kHz}$ ,	$A_V = 1$	200		$\Omega$		
CMRR	Common-mode rejection ratio	$V_{IC} = 0\text{ to }2.7\text{ V}$ ,	$V_O = 2.5\text{ V}$ ,	$R_S = 50\ \Omega$		83		dB
$k_{SVR}$	Supply voltage rejection ratio ( $\Delta V_{DD}/\Delta V_{IO}$ )	$V_{DD} = 4.4\text{ V to }8\text{ V}$ ,	$V_{IC} = V_{DD}/2$ ,	No load		95		dB
$I_{DD}$	Supply current	$V_O = 2.5\text{ V}$ ,	No load		13		$\mu\text{A}$	

$^\dagger$  Referenced to 1.5 V

**TYPICAL CHARACTERISTICS**

**Table of Graphs**

			<b>FIGURE</b>
$V_{IO}$	Input offset voltage	Distribution vs Common-mode input voltage	2, 3 4, 5
$\alpha V_{IO}$	Input offset voltage temperature coefficient	Distribution	6, 7
$I_{IB}/I_{IO}$	Input bias and input offset currents	vs Free-air temperature	8
$V_I$	Input voltage	vs Supply voltage vs Free-air temperature	9 10
$V_{OH}$	High-level output voltage	vs High-level output current	11, 14
$V_{OL}$	Low-level output voltage	vs Low-level output current	12, 13, 15
$V_{O(PP)}$	Maximum peak-to-peak output voltage	vs Frequency	16
$I_{OS}$	Short-circuit output current	vs Supply voltage vs Free-air temperature	17 18
$V_O$	Output voltage	vs Differential input voltage	19, 20
$A_{VD}$	Large-signal differential voltage amplification and phase margin	vs Load resistance vs Frequency vs Free-air temperature	21 22, 23 24, 25
$z_o$	Output impedance	vs Frequency	26, 27
CMRR	Common-mode rejection ratio	vs Frequency vs Free-air temperature	28 29
$k_{SVR}$	Supply-voltage rejection ratio	vs Frequency vs Free-air temperature	30, 31 32
$I_{DD}$	Supply current	vs Supply voltage	33
SR	Slew rate	vs Load capacitance vs Free-air temperature	34 35
$V_O$	Large-signal pulse response	vs Time	36, 37, 38, 39
	Inverting small-signal pulse response		40, 41
	Small-signal pulse response		42, 43
$V_n$	Equivalent input noise voltage	vs Frequency	44, 45
	Noise voltage (referred to input)	Over a 10-second period	46
THD + N	Total harmonic distortion plus noise	vs Frequency	47
	Gain-bandwidth product	vs Free-air temperature vs Supply voltage	48 49
$\phi_m$	Phase margin	vs Frequency vs Load capacitance	23, 24 50
	Gain margin	vs Load capacitance	51
$B_1$	Unity-gain bandwidth	vs Load capacitance	52

**TYPICAL CHARACTERISTICS**

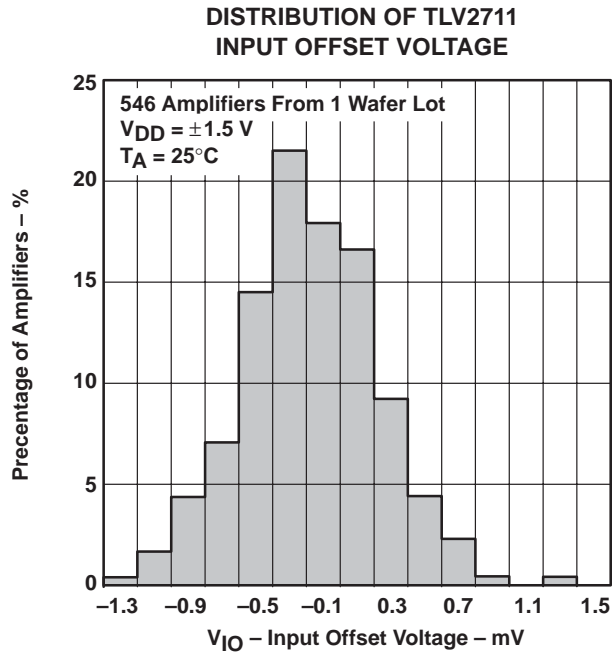

**Figure 2**

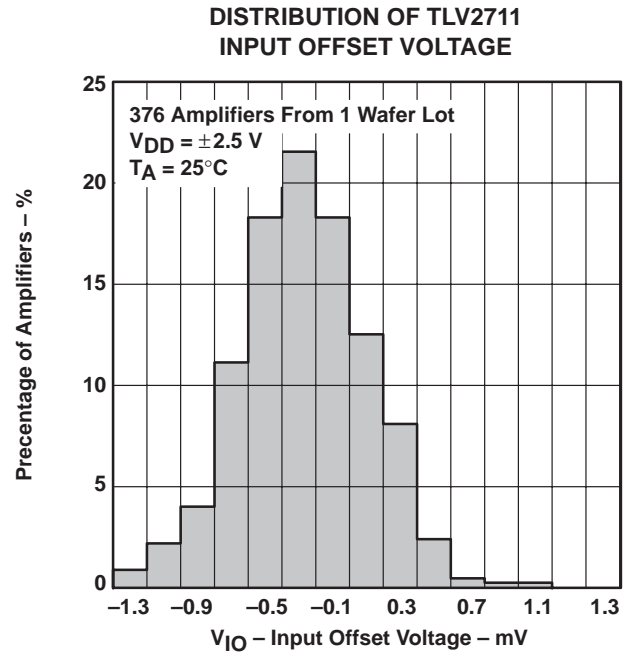

**Figure 3**

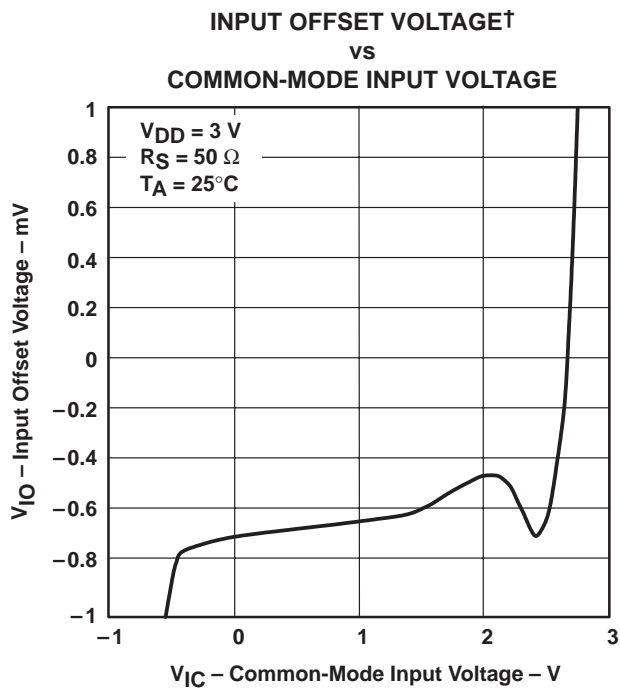

**Figure 4**

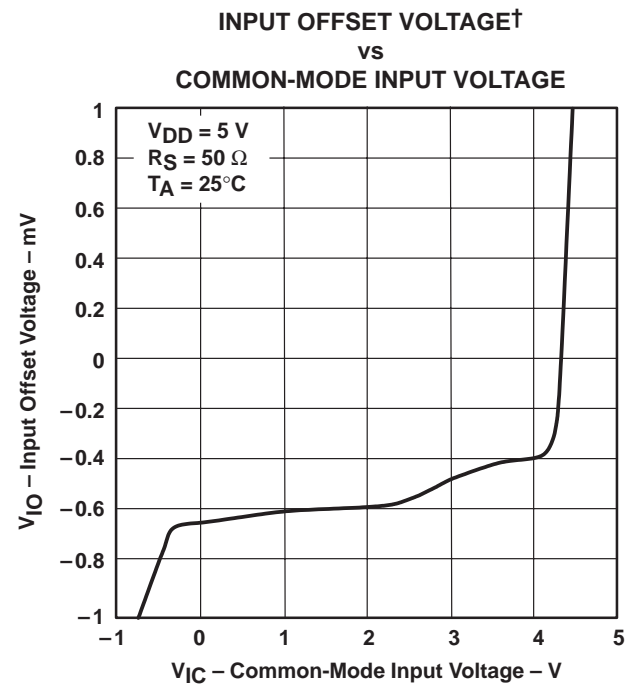

**Figure 5**

† For all curves where  $V_{DD} = 5\text{ V}$ , all loads are referenced to 2.5 V. For all curves where  $V_{DD} = 3\text{ V}$ , all loads are referenced to 1.5 V.

TYPICAL CHARACTERISTICS

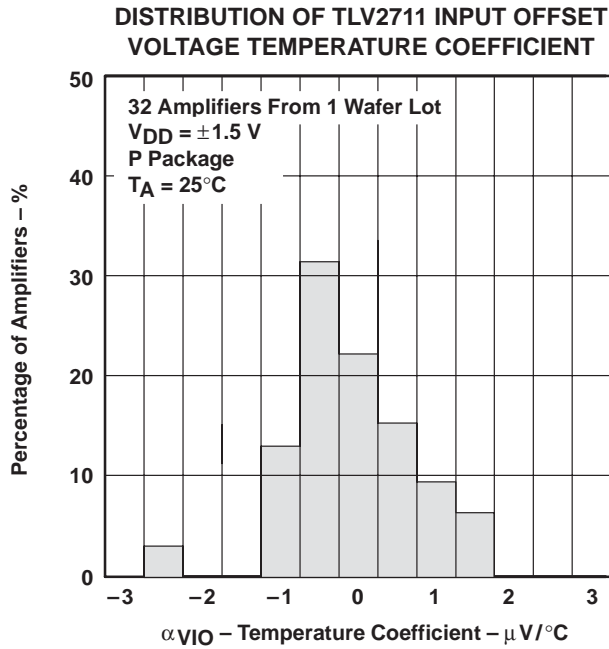

Figure 6

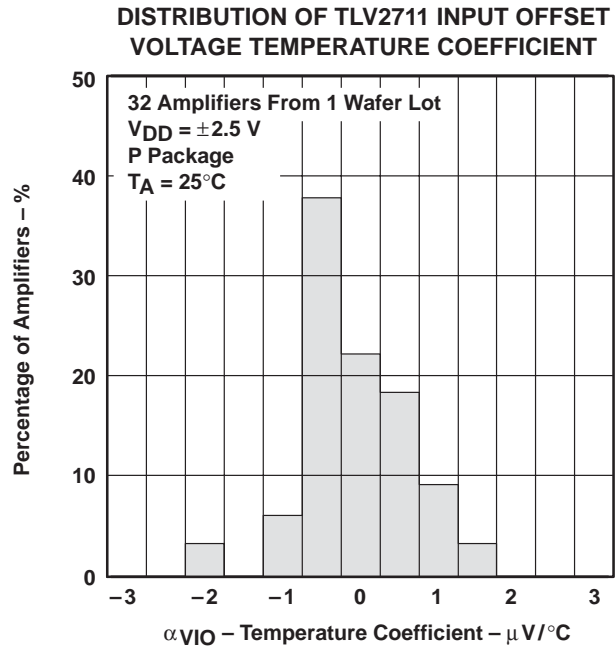

Figure 7

INPUT BIAS AND INPUT OFFSET CURRENTS†  
 vs  
 FREE-AIR TEMPERATURE

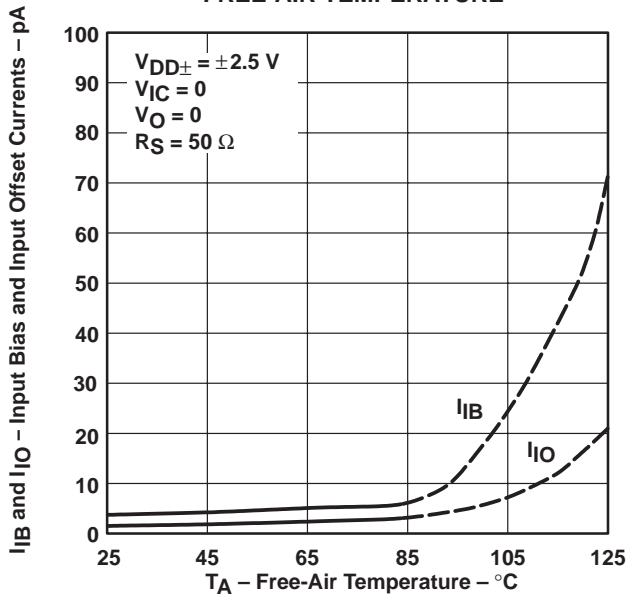

Figure 8

INPUT VOLTAGE  
 vs  
 SUPPLY VOLTAGE

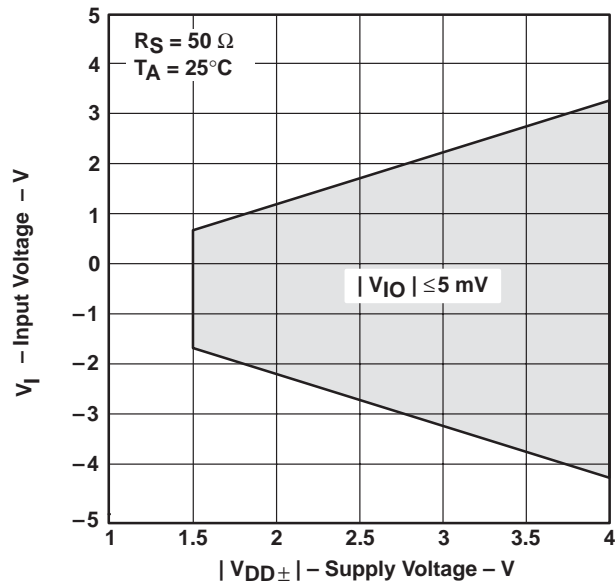
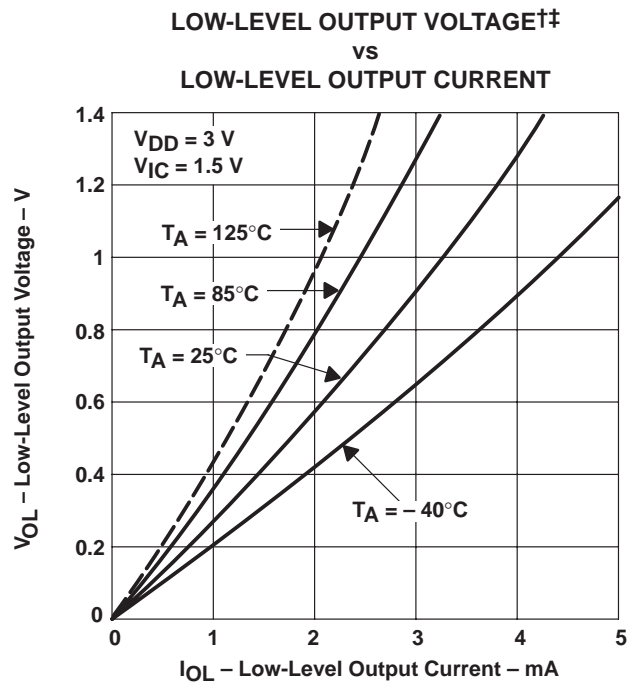
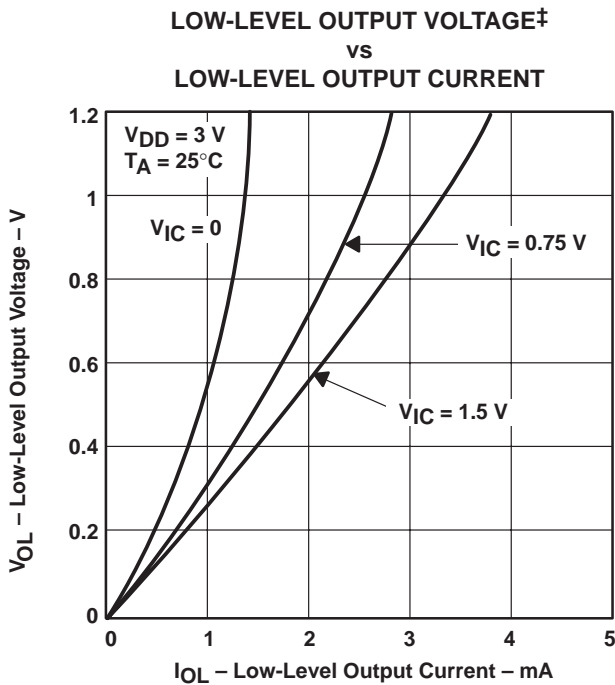
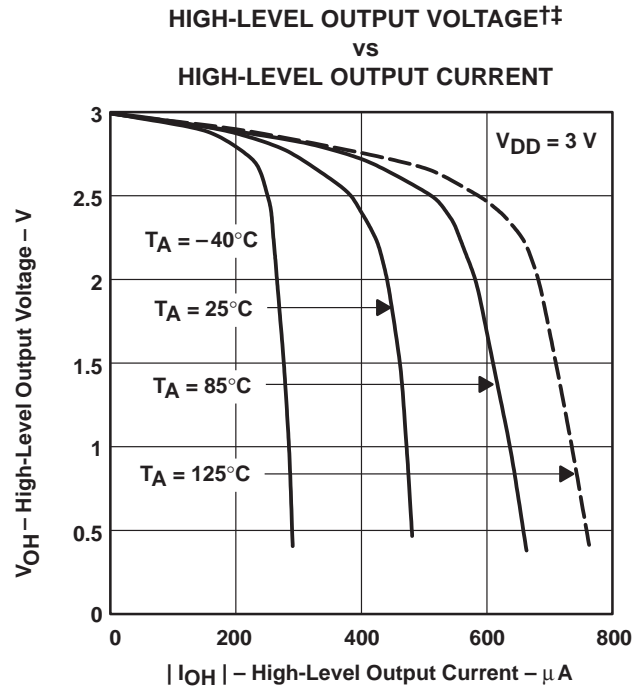
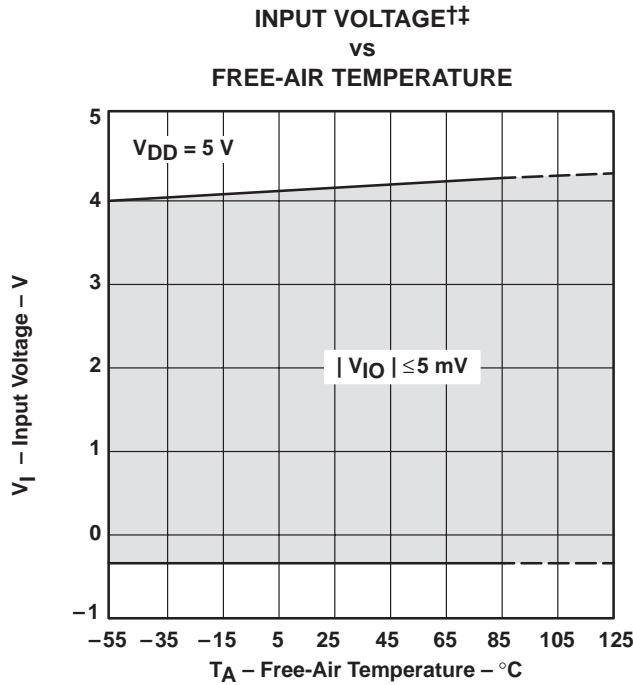

Figure 9

† Data at high and low temperatures are applicable only within the rated operating free-air temperature ranges of the various devices.

**TYPICAL CHARACTERISTICS**



† Data at high and low temperatures are applicable only within the rated operating free-air temperature ranges of the various devices.  
 ‡ For all curves where  $V_{DD} = 5\text{ V}$ , all loads are referenced to 2.5 V. For all curves where  $V_{DD} = 3\text{ V}$ , all loads are referenced to 1.5 V.

TYPICAL CHARACTERISTICS

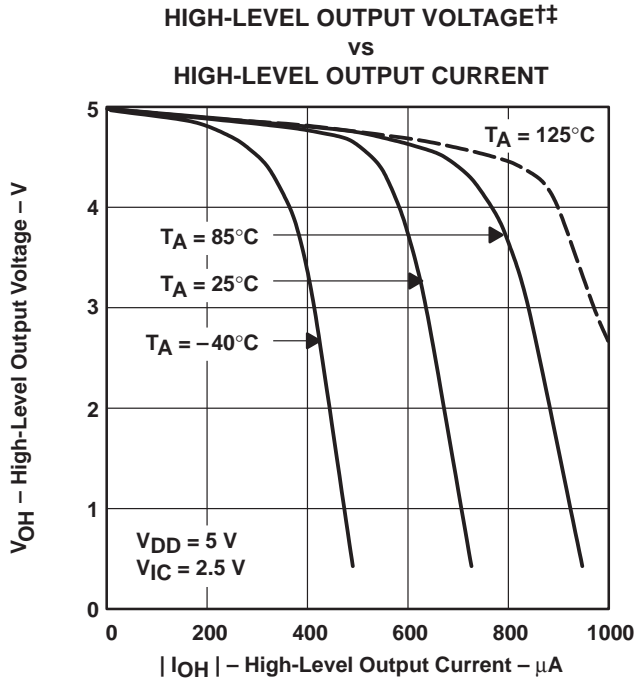

Figure 14

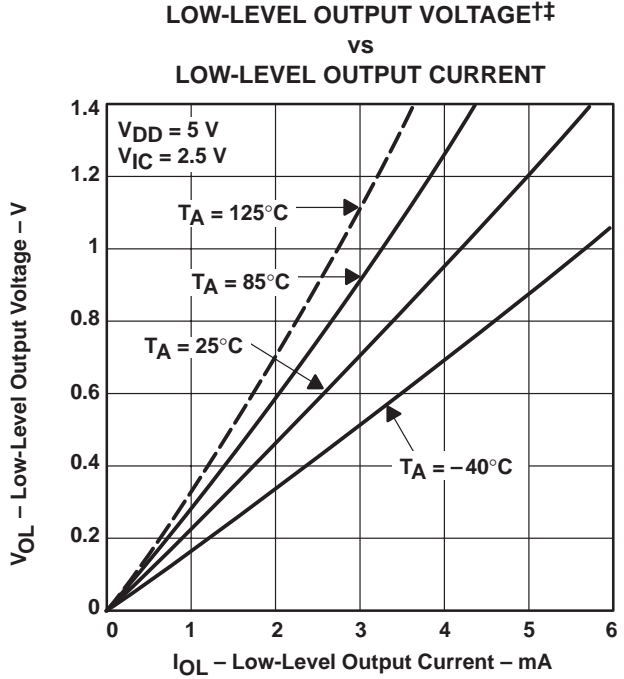

Figure 15

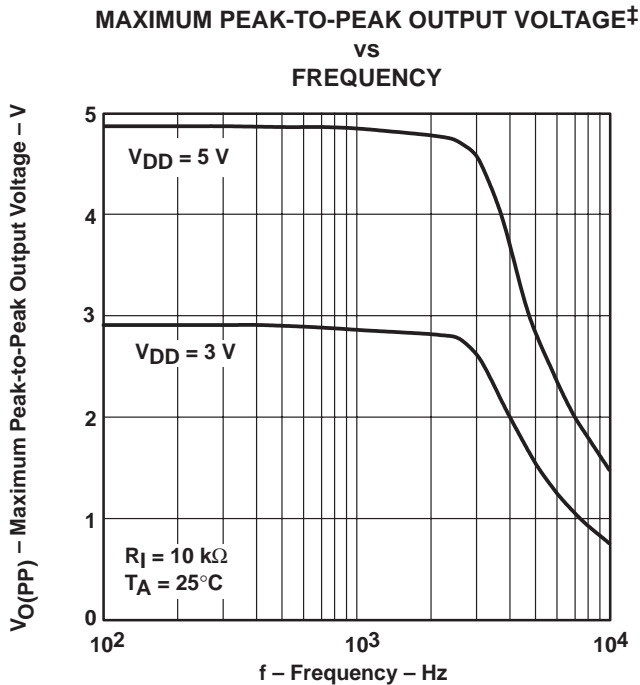

Figure 16

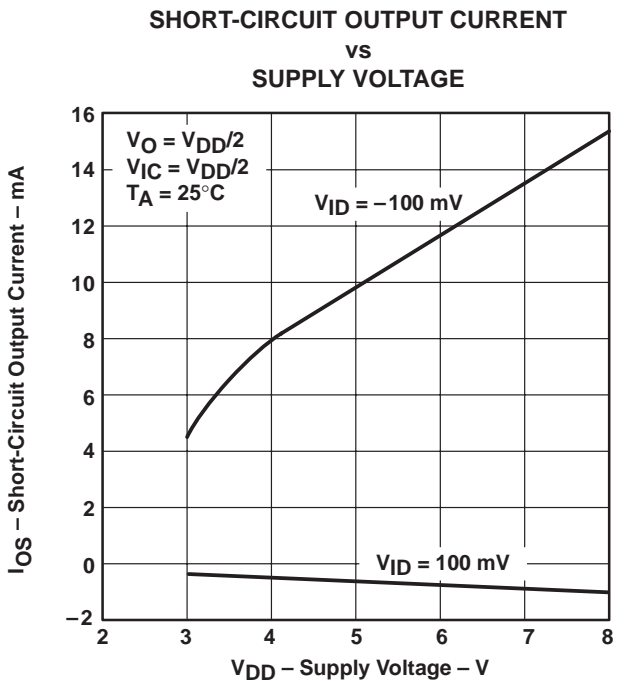
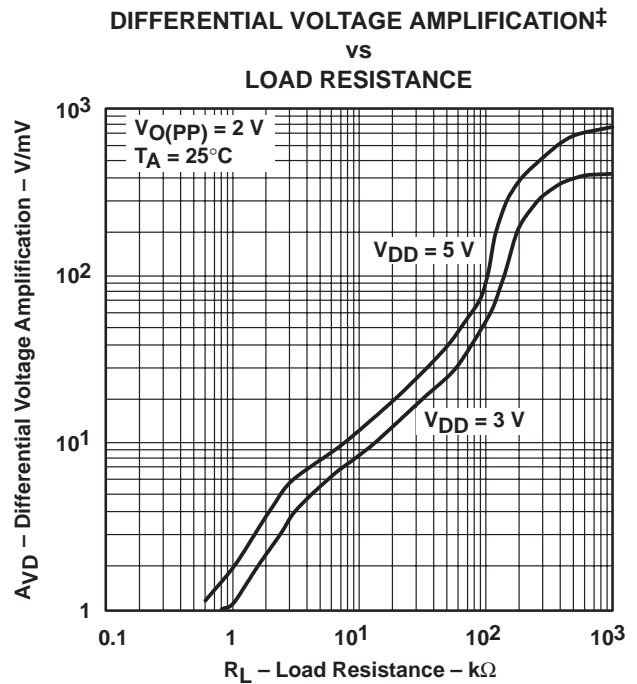
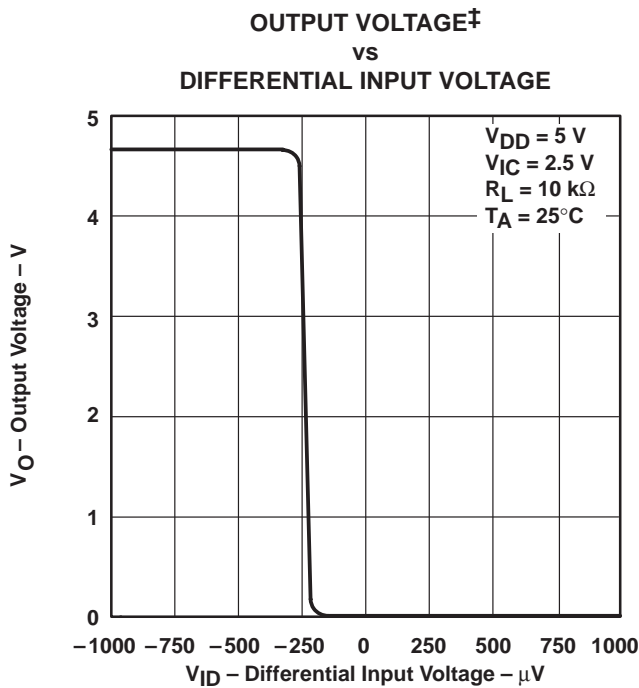
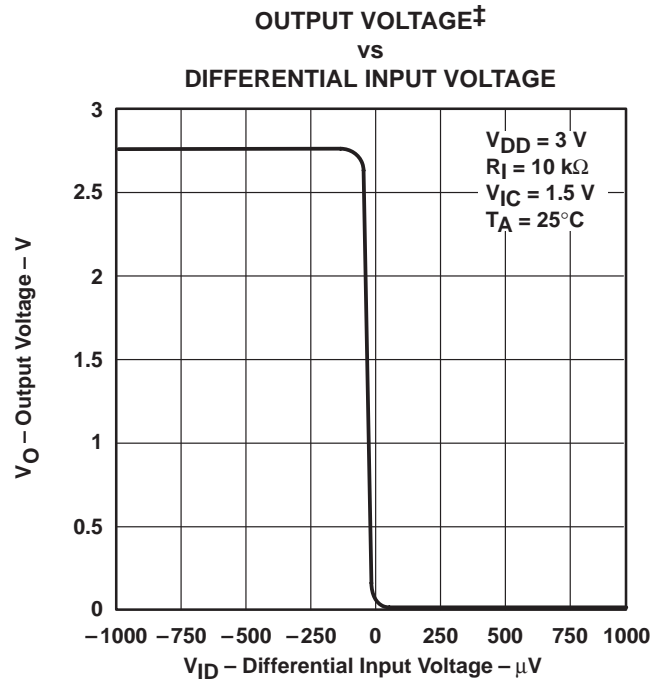
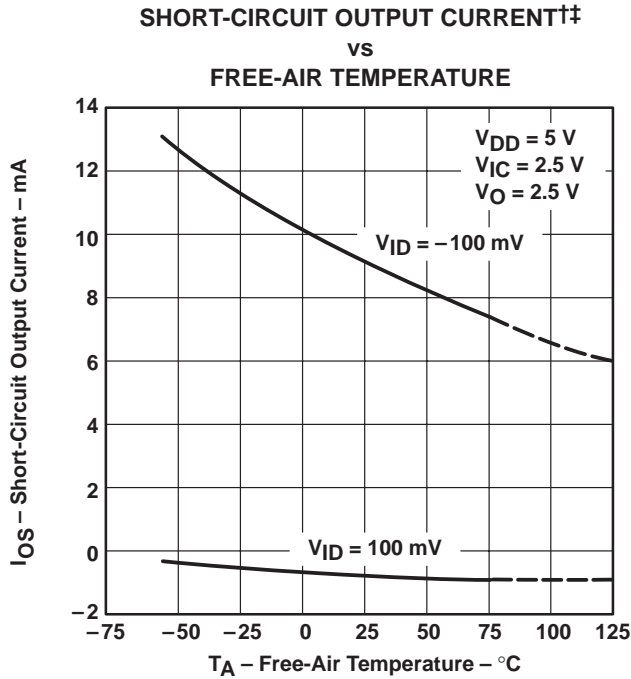

Figure 17

† Data at high and low temperatures are applicable only within the rated operating free-air temperature ranges of the various devices.  
 ‡ For all curves where  $V_{DD} = 5\text{ V}$ , all loads are referenced to 2.5 V. For all curves where  $V_{DD} = 3\text{ V}$ , all loads are referenced to 1.5 V.

**TYPICAL CHARACTERISTICS**



† Data at high and low temperatures are applicable only within the rated operating free-air temperature ranges of the various devices.

‡ For all curves where  $V_{DD} = 5\text{ V}$ , all loads are referenced to 2.5 V. For all curves where  $V_{DD} = 3\text{ V}$ , all loads are referenced to 1.5 V.

TYPICAL CHARACTERISTICS

LARGE-SIGNAL DIFFERENTIAL VOLTAGE  
 AMPLIFICATION AND PHASE MARGIN†  
 vs  
 FREQUENCY

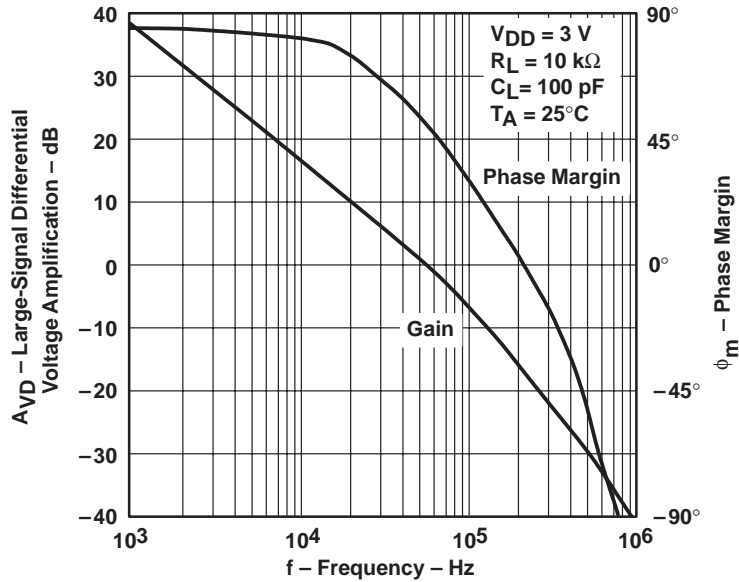

Figure 22

LARGE-SIGNAL DIFFERENTIAL VOLTAGE  
 AMPLIFICATION AND PHASE MARGIN†  
 vs  
 FREQUENCY

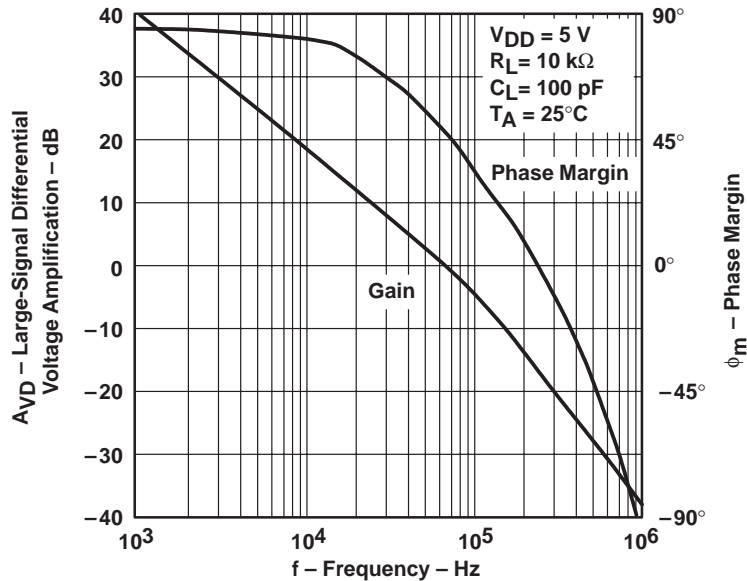
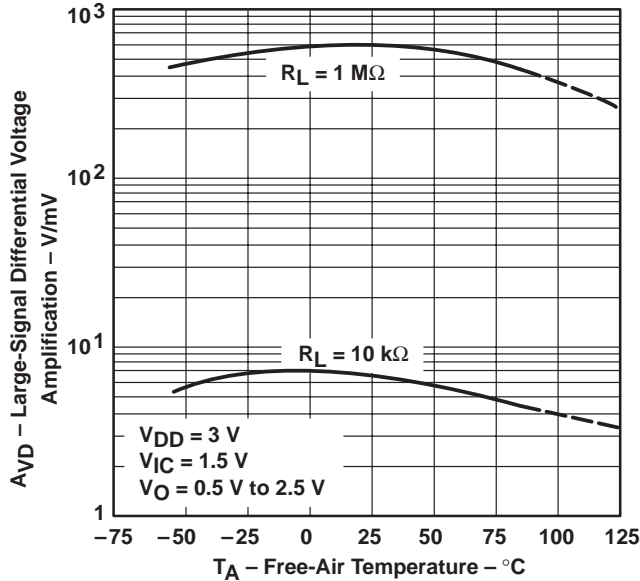

Figure 23

† For all curves where  $V_{DD} = 5\text{ V}$ , all loads are referenced to 2.5 V. For all curves where  $V_{DD} = 3\text{ V}$ , all loads are referenced to 1.5 V.

**TYPICAL CHARACTERISTICS**

**LARGE-SIGNAL DIFFERENTIAL  
 VOLTAGE AMPLIFICATION†‡  
 vs  
 FREE-AIR TEMPERATURE**



**LARGE-SIGNAL DIFFERENTIAL  
 VOLTAGE AMPLIFICATION†‡  
 vs  
 FREE-AIR TEMPERATURE**

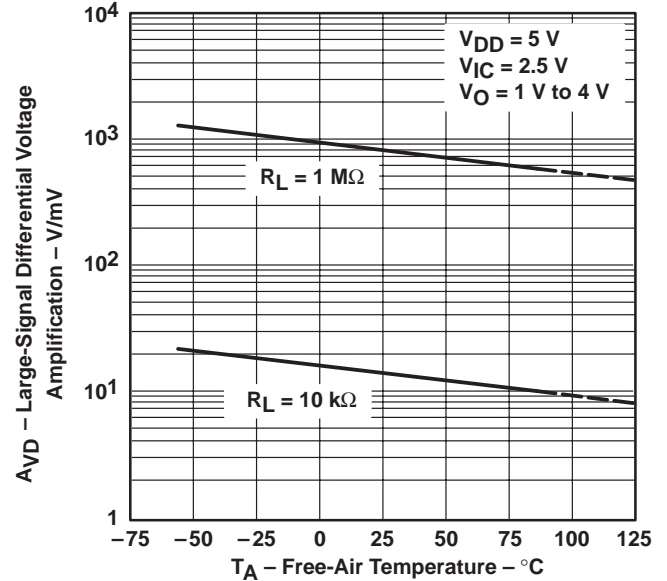

**OUTPUT IMPEDANCE‡  
 vs  
 FREQUENCY**

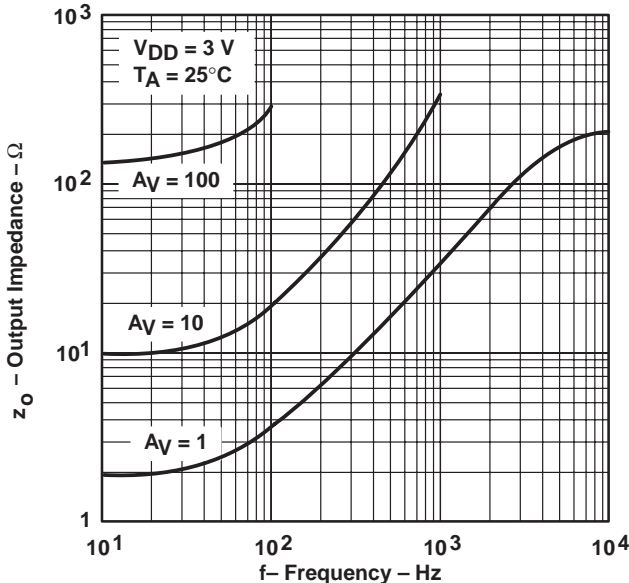

**OUTPUT IMPEDANCE‡  
 vs  
 FREQUENCY**

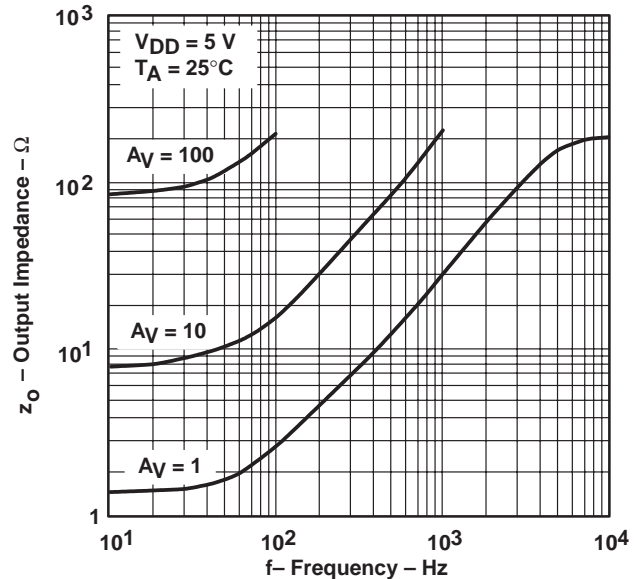

† Data at high and low temperatures are applicable only within the rated operating free-air temperature ranges of the various devices.  
 ‡ For all curves where  $V_{DD} = 5\text{ V}$ , all loads are referenced to 2.5 V. For all curves where  $V_{DD} = 3\text{ V}$ , all loads are referenced to 1.5 V.

TYPICAL CHARACTERISTICS

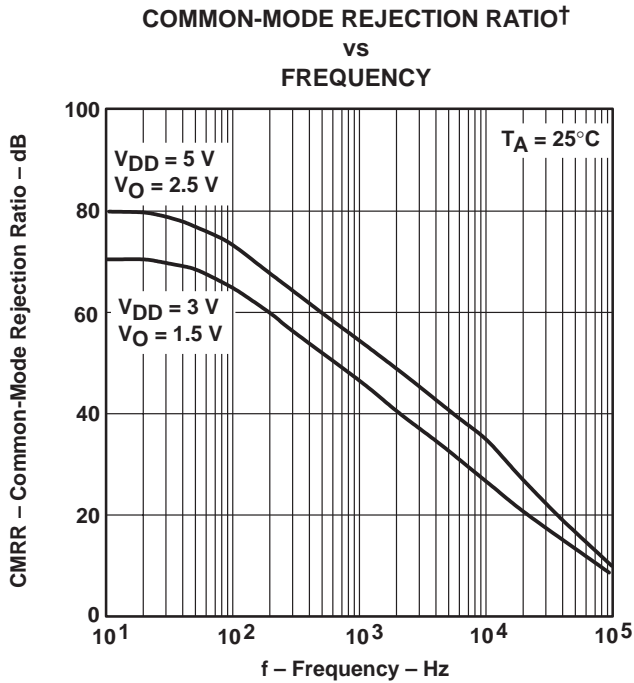

Figure 28

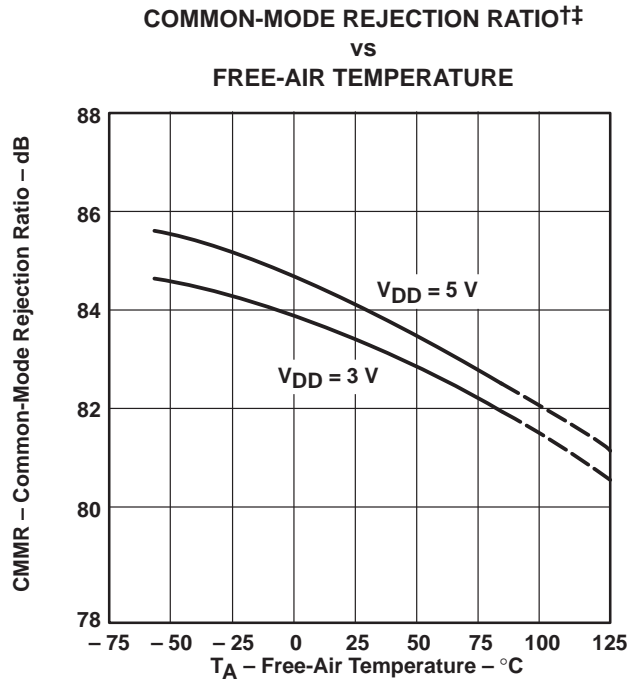

Figure 29

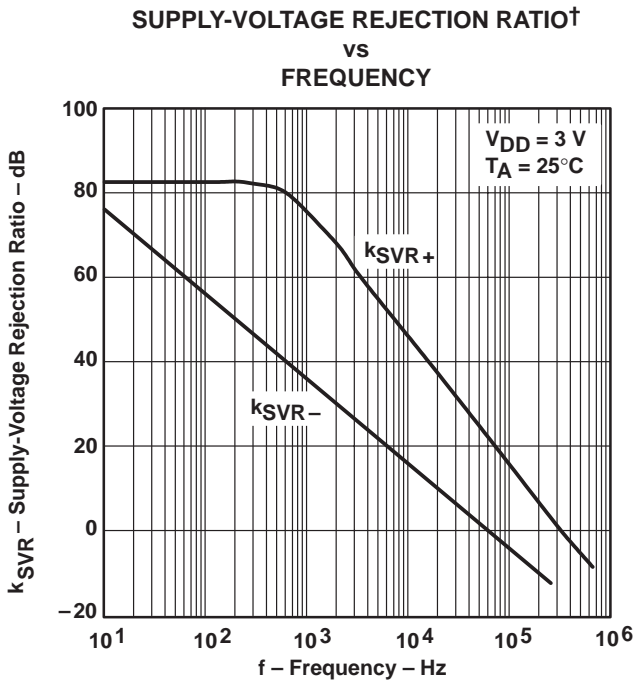

Figure 30

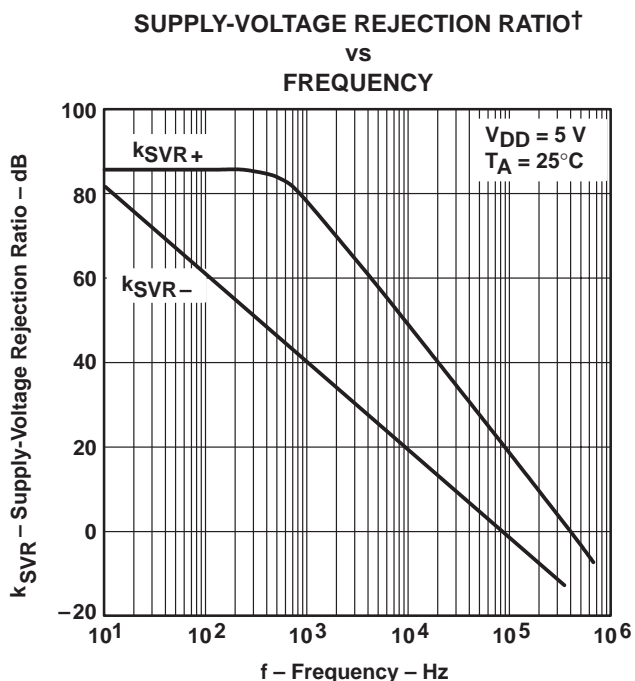
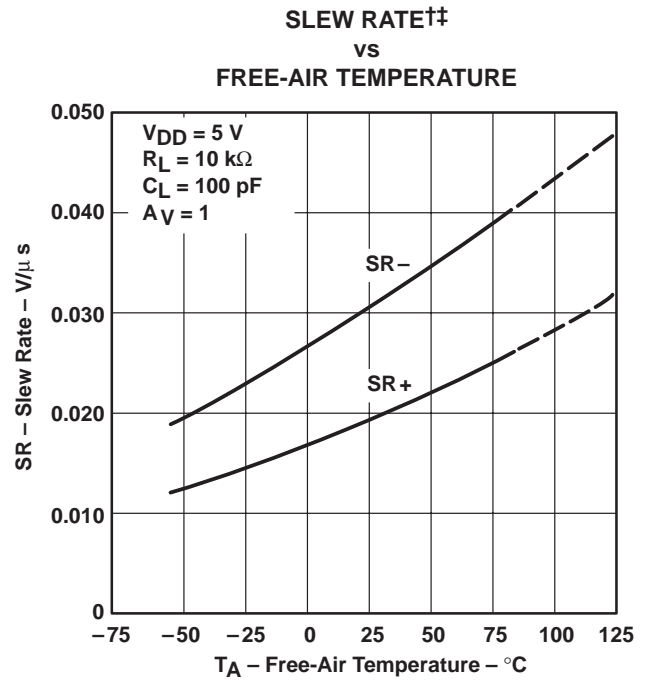
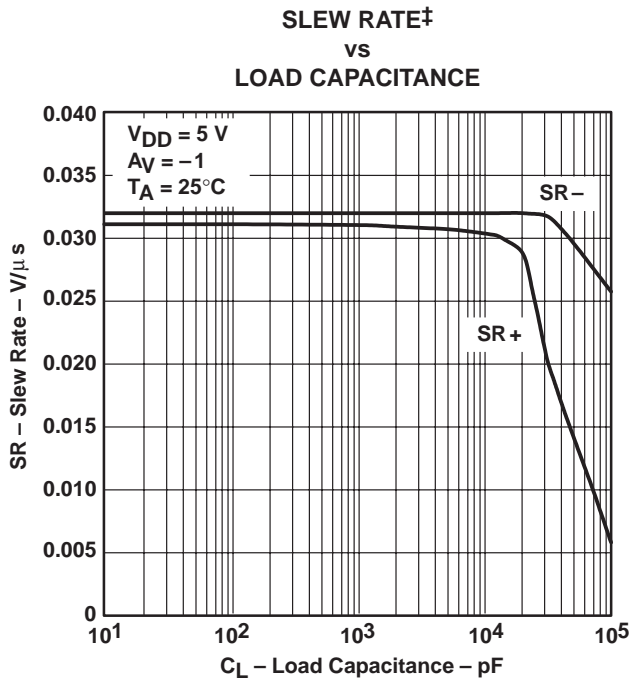
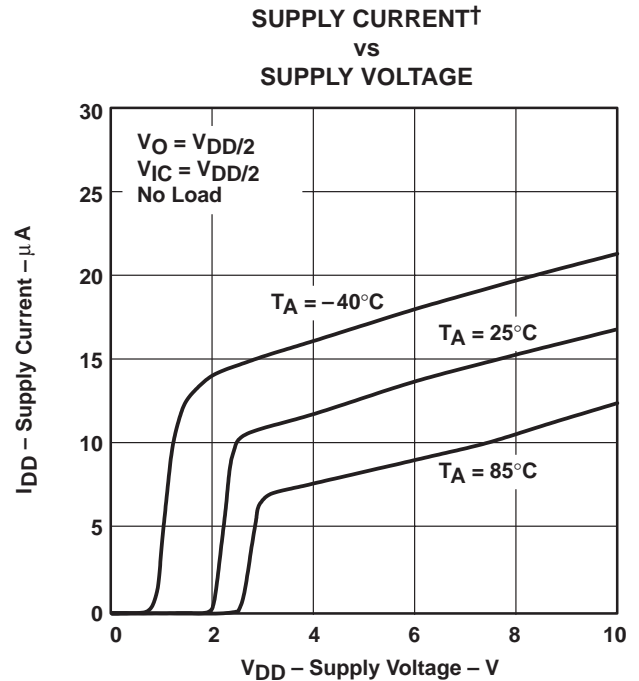
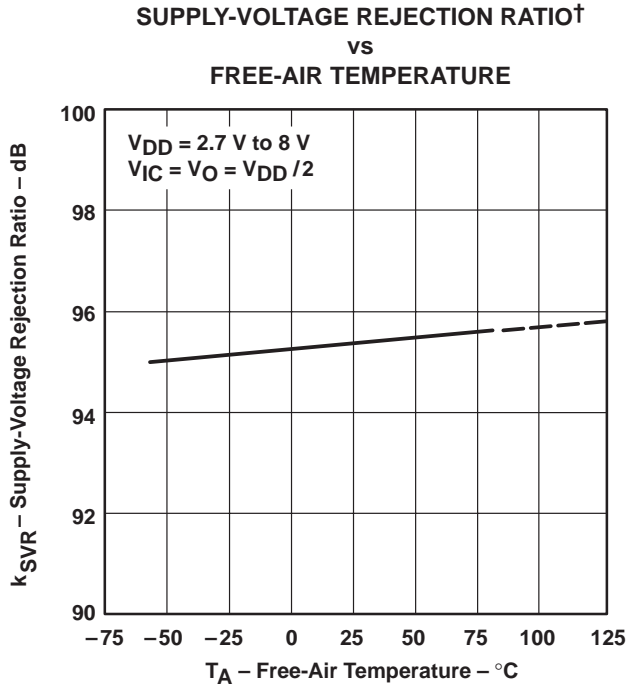

Figure 31

† For all curves where  $V_{DD} = 5\text{ V}$ , all loads are referenced to 2.5 V. For all curves where  $V_{DD} = 3\text{ V}$ , all loads are referenced to 1.5 V.  
 ‡ Data at high and low temperatures are applicable only within the rated operating free-air temperature ranges of the various devices.

**TYPICAL CHARACTERISTICS**



† Data at high and low temperatures are applicable only within the rated operating free-air temperature ranges of the various devices.

‡ For all curves where  $V_{DD} = 5\text{ V}$ , all loads are referenced to 2.5 V. For all curves where  $V_{DD} = 3\text{ V}$ , all loads are referenced to 1.5 V.

TYPICAL CHARACTERISTICS

INVERTING LARGE-SIGNAL PULSE RESPONSE†

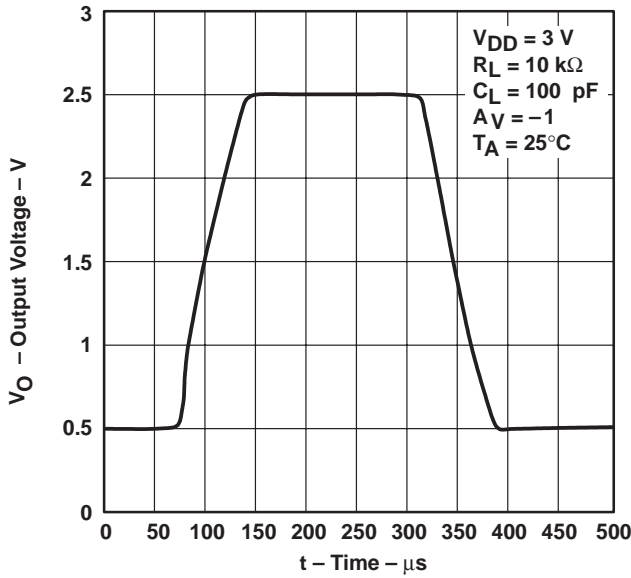

Figure 36

INVERTING LARGE-SIGNAL PULSE RESPONSE†

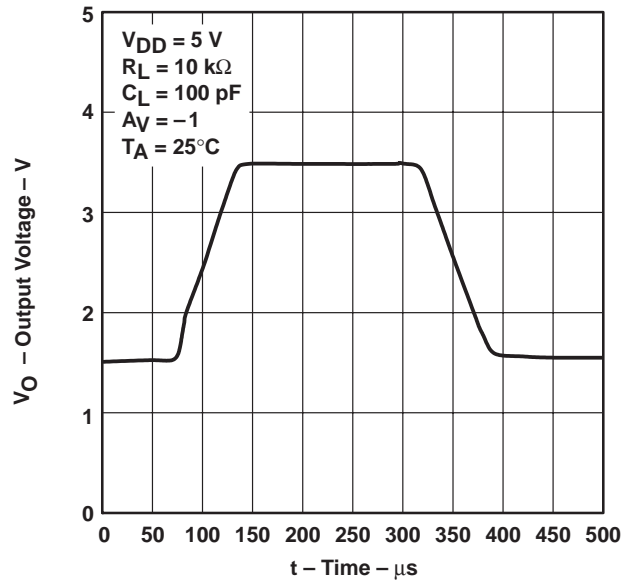

Figure 37

VOLTAGE-FOLLOWER LARGE-SIGNAL PULSE RESPONSE†

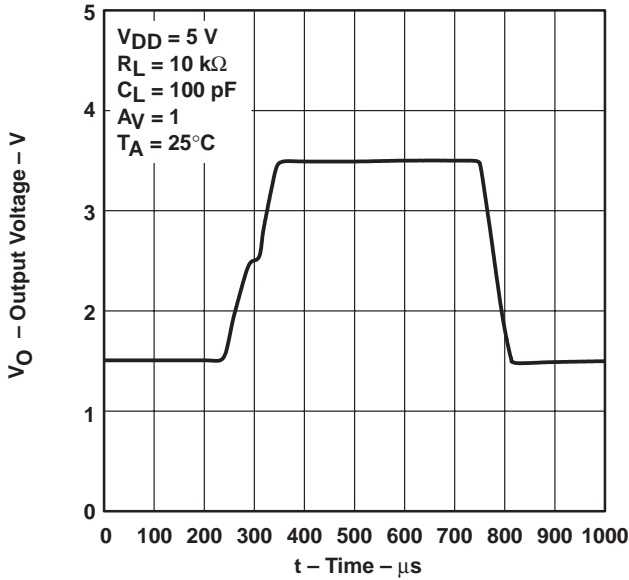

Figure 38

VOLTAGE-FOLLOWER LARGE-SIGNAL PULSE RESPONSE†

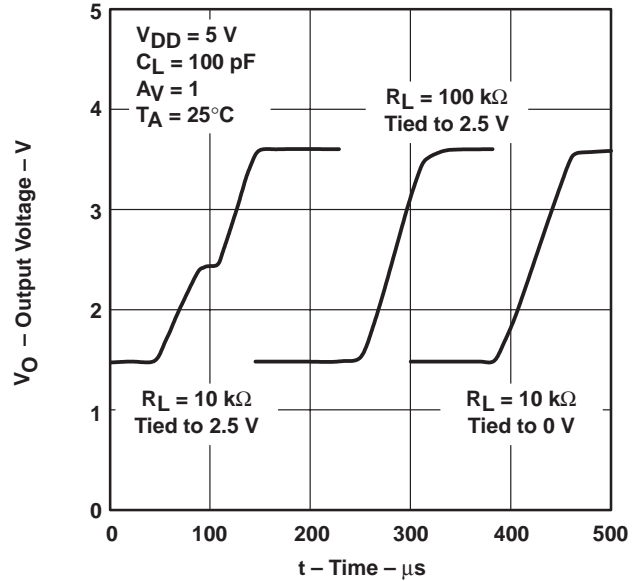
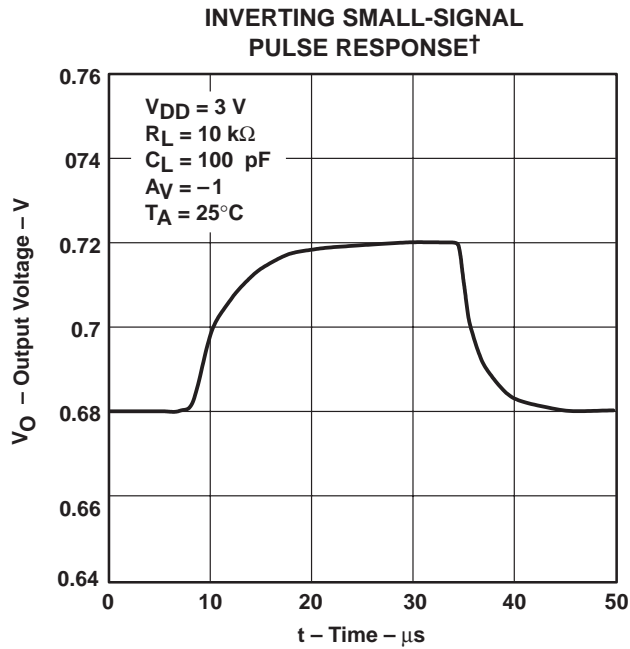

Figure 39

† For all curves where  $V_{DD} = 5\text{ V}$ , all loads are referenced to 2.5 V. For all curves where  $V_{DD} = 3\text{ V}$ , all loads are referenced to 1.5 V.

**TYPICAL CHARACTERISTICS**



**Figure 40**

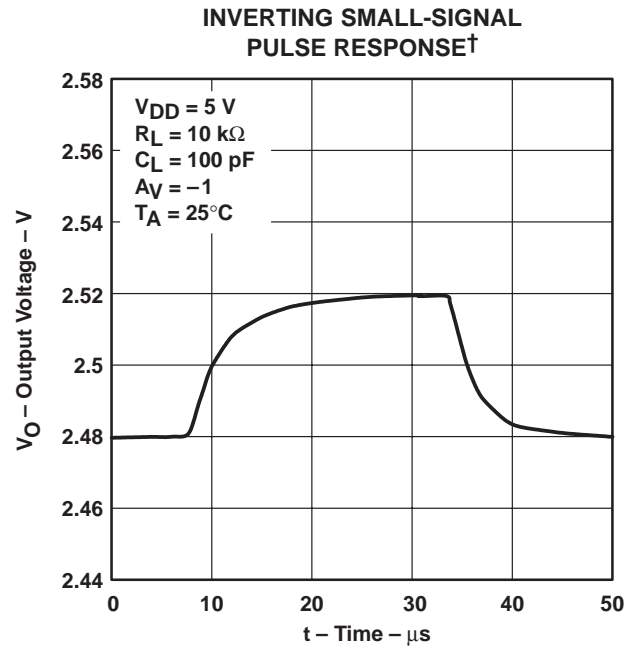

**Figure 41**

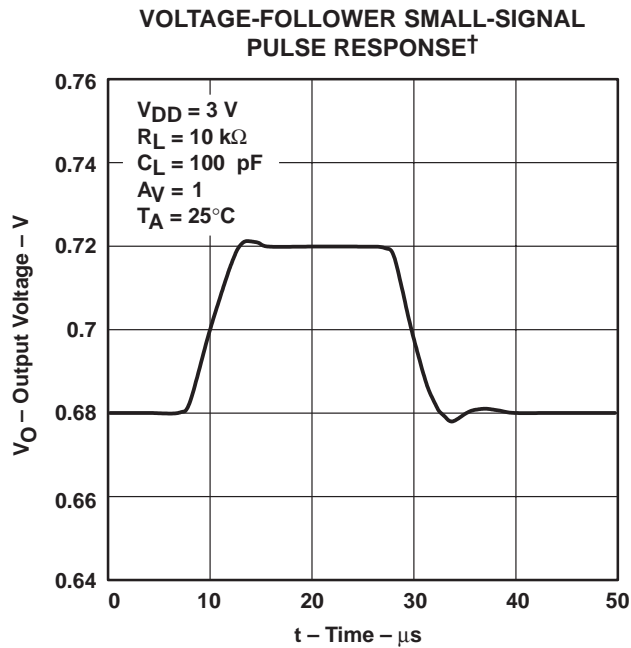

**Figure 42**

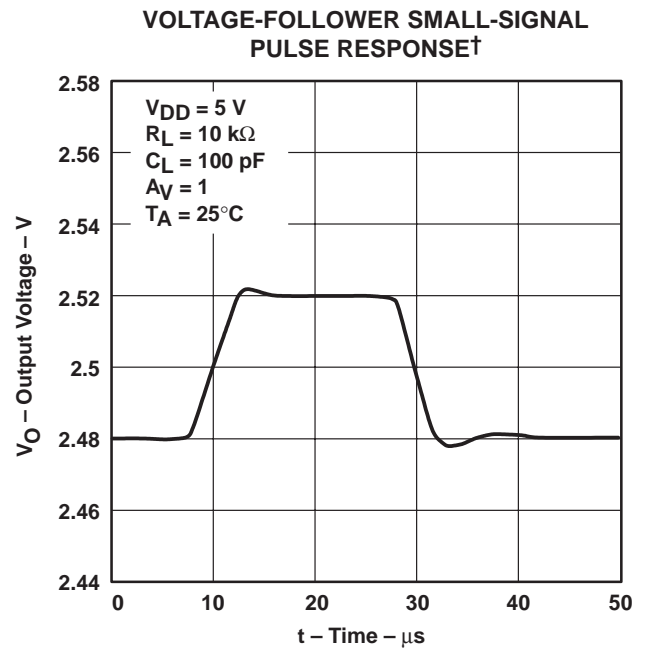

**Figure 43**

† For all curves where  $V_{DD} = 5\text{ V}$ , all loads are referenced to 2.5 V. For all curves where  $V_{DD} = 3\text{ V}$ , all loads are referenced to 1.5 V.

TYPICAL CHARACTERISTICS

EQUIVALENT INPUT NOISE VOLTAGE†  
 VS  
 FREQUENCY

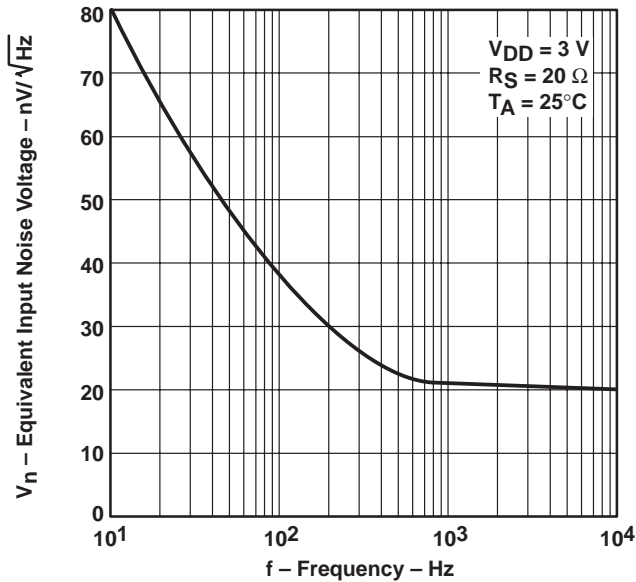

Figure 44

EQUIVALENT INPUT NOISE VOLTAGE†  
 VS  
 FREQUENCY

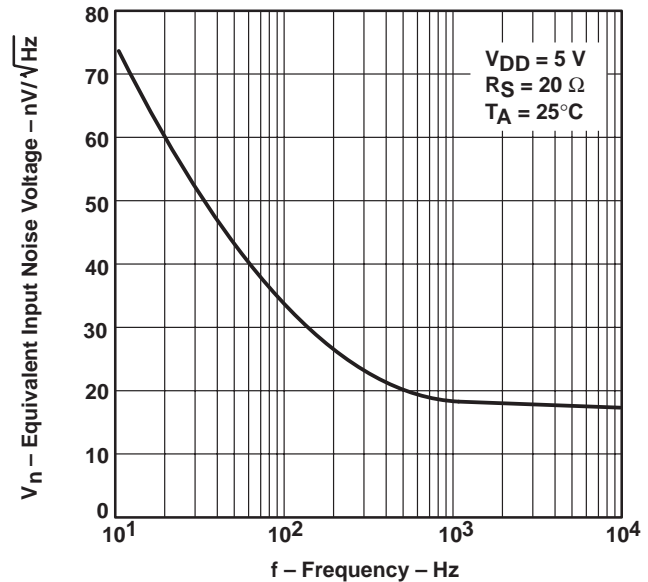

Figure 45

INPUT NOISE VOLTAGE OVER  
 A 10-SECOND PERIOD†

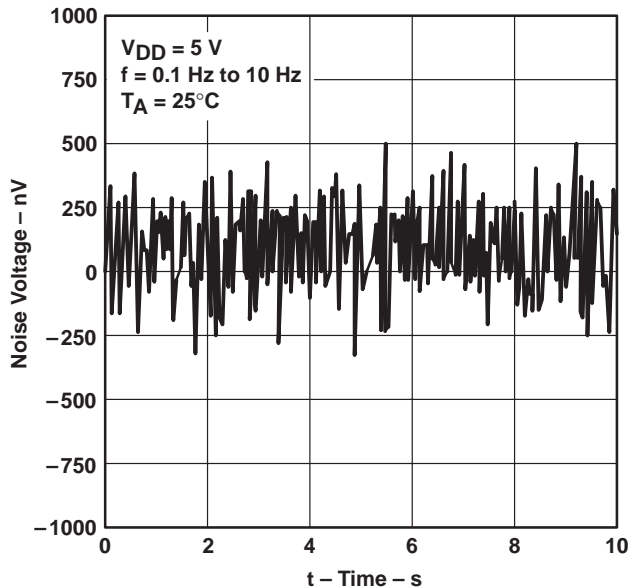

Figure 46

TOTAL HARMONIC DISTORTION PLUS NOISE†  
 VS  
 FREQUENCY

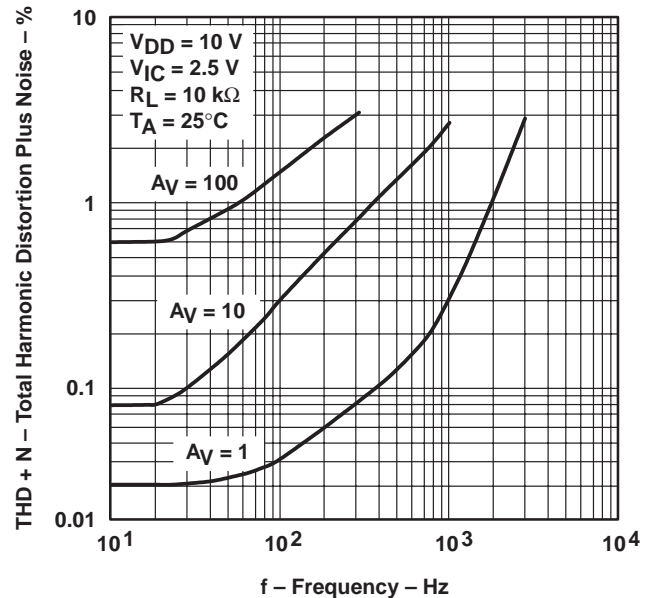
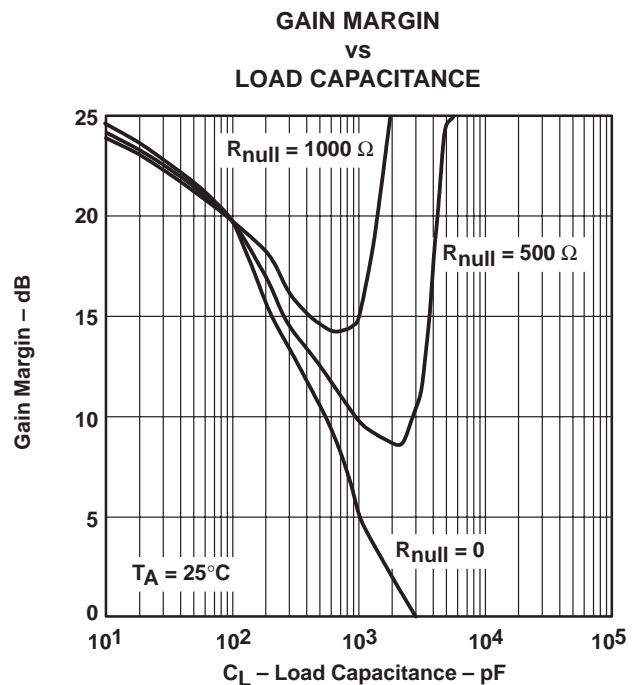
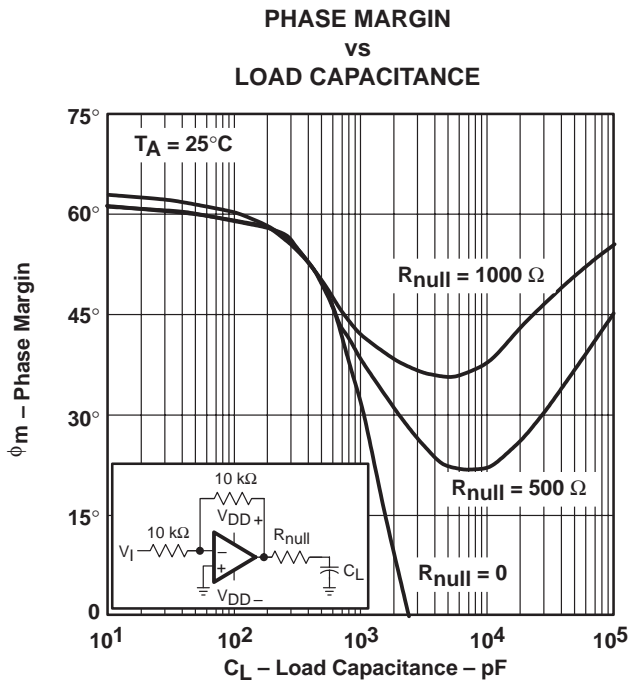
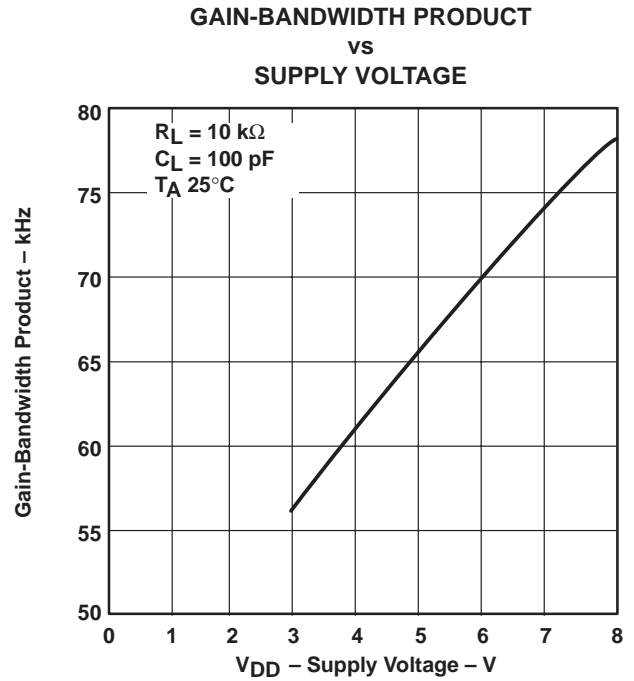
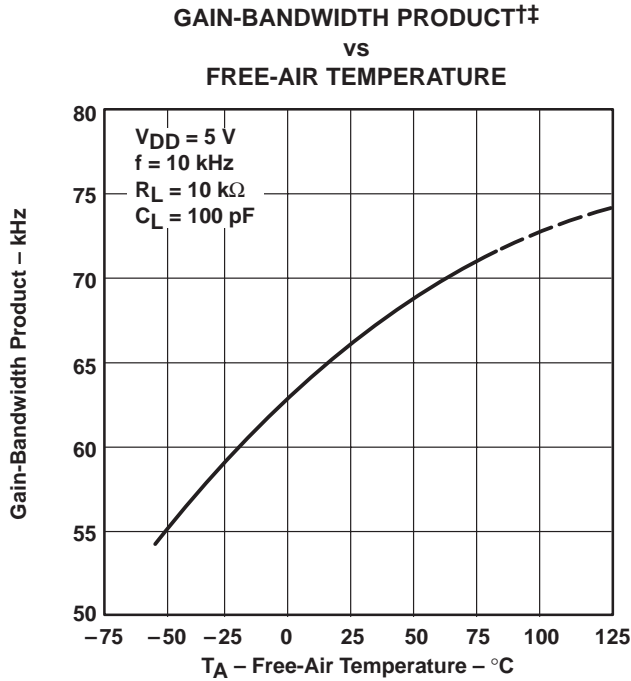

Figure 47

† For all curves where  $V_{DD} = 5\text{ V}$ , all loads are referenced to 2.5 V. For all curves where  $V_{DD} = 3\text{ V}$ , all loads are referenced to 1.5 V.

**TYPICAL CHARACTERISTICS**



† Data at high and low temperatures are applicable only within the rated operating free-air temperature ranges of the various devices.  
‡ For all curves where  $V_{DD} = 5\text{ V}$ , all loads are referenced to 2.5 V. For all curves where  $V_{DD} = 3\text{ V}$ , all loads are referenced to 1.5 V.

TYPICAL CHARACTERISTICS

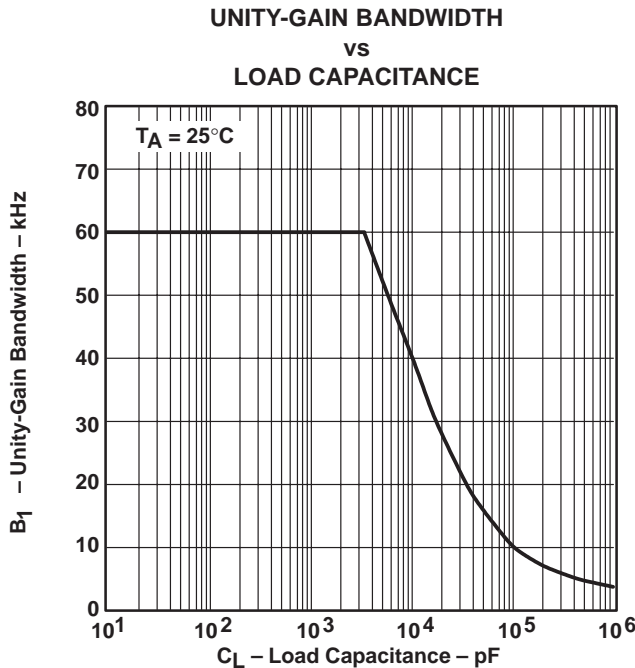

Figure 52

APPLICATION INFORMATION

driving large capacitive loads

The TLV2711 is designed to drive larger capacitive loads than most CMOS operational amplifiers. Figure 50 and Figure 51 illustrate its ability to drive loads up to 600 pF while maintaining good gain and phase margins ( $R_{null} = 0$ ).

A smaller series resistor ( $R_{null}$ ) at the output of the device (see Figure 53) improves the gain and phase margins when driving large capacitive loads. Figure 50 and Figure 51 show the effects of adding series resistances of 500 Ω and 1000 Ω. The addition of this series resistor has two effects: the first is that it adds a zero to the transfer function and the second is that it reduces the frequency of the pole associated with the output load in the transfer function.

The zero introduced to the transfer function is equal to the series resistance times the load capacitance. To calculate the improvement in phase margin, equation 1 can be used.

$$\Delta\phi_{m1} = \tan^{-1} \left( 2 \times \pi \times \text{UGBW} \times R_{null} \times C_L \right) \tag{1}$$

Where :

- $\Delta\phi_{m1}$  = Improvement in phase margin
- UGBW = Unity-gain bandwidth frequency
- $R_{null}$  = Output series resistance
- $C_L$  = : Load capacitance

## APPLICATION INFORMATION

### driving large capacitive loads (continued)

The unity-gain bandwidth (UGBW) frequency decreases as the capacitive load increases (see Figure 52). To use equation 1, UGBW must be approximated from Figure 52.

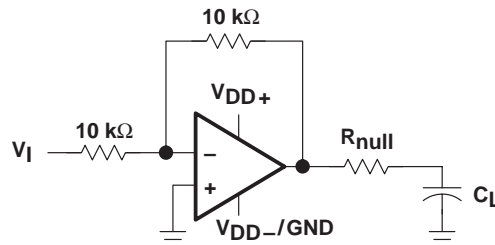

Figure 53. Series-Resistance Circuit

### driving heavy dc loads

The TLV2711 is designed to provide better sinking and sourcing output currents than earlier CMOS rail-to-rail output devices. This device is specified to sink 500  $\mu\text{A}$  and source 250  $\mu\text{A}$  at  $V_{\text{DD}} = 3\text{ V}$  and  $V_{\text{DD}} = 5\text{ V}$  at a maximum quiescent  $I_{\text{DD}}$  of 25  $\mu\text{A}$ . This provides a greater than 90% power efficiency.

When driving heavy dc loads, such as 10 k $\Omega$ , the positive edge under slewing conditions can experience some distortion. This condition can be seen in Figure 38. This condition is affected by three factors.

- Where the load is referenced. When the load is referenced to either rail, this condition does not occur. The distortion occurs only when the output signal swings through the point where the load is referenced. Figure 39 illustrates two 10-k $\Omega$  load conditions. The first load condition shows the distortion seen for a 10-k $\Omega$  load tied to 2.5 V. The third load condition shows no distortion for a 10-k $\Omega$  load tied to 0 V.
- Load resistance. As the load resistance increases, the distortion seen on the output decreases. Figure 39 illustrates the difference seen on the output for a 10-k $\Omega$  load and a 100-k $\Omega$  load with both tied to 2.5 V.
- Input signal edge rate. Faster input edge rates for a step input result in more distortion than with slower input edge rates.

# TLV2711, TLV2711Y

## Advanced LinCMOS™ RAIL-TO-RAIL

### MICROPOWER SINGLE OPERATIONAL AMPLIFIERS

SLOS196A – AUGUST 1997 – REVISED MARCH 2001

## APPLICATION INFORMATION

### macromodel information

Macromodel information provided was derived using Microsim *Parts*™, the model generation software used with Microsim *PSpice*™. The Boyle macromodel (see Note 6) and subcircuit in Figure 54 are generated using the TLV2711 typical electrical and operating characteristics at  $T_A = 25^\circ\text{C}$ . Using this information, output simulations of the following key parameters can be generated to a tolerance of 20% (in most cases):

- Maximum positive output voltage swing
- Maximum negative output voltage swing
- Slew rate
- Quiescent power dissipation
- Input bias current
- Open-loop voltage amplification
- Unity-gain frequency
- Common-mode rejection ratio
- Phase margin
- DC output resistance
- AC output resistance
- Short-circuit output current limit

NOTE 6: G. R. Boyle, B. M. Cohn, D. O. Pederson, and J. E. Solomon, "Macromodeling of Integrated Circuit Operational Amplifiers", *IEEE Journal of Solid-State Circuits*, SC-9, 353 (1974).

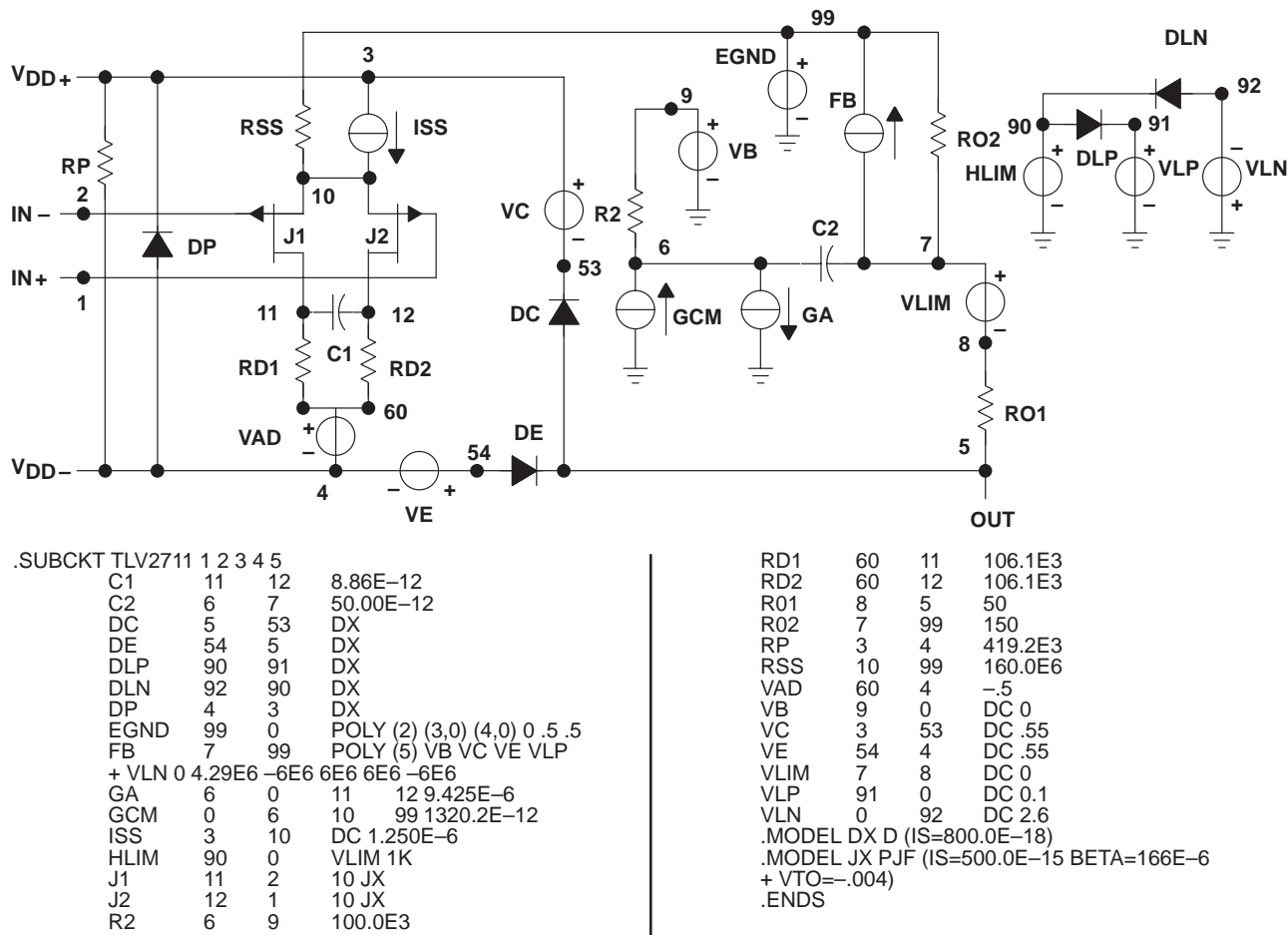

Figure 54. Boyle Macromodel and Subcircuit

*PSpice* and *Parts* are trademark of MicroSim Corporation.

Macromodels, simulation models, or other models provided by TI, directly or indirectly, are not warranted by TI as fully representing all of the specification and operating characteristics of the semiconductor product to which the model relates.



POST OFFICE BOX 655303 • DALLAS, TEXAS 75265

**PACKAGING INFORMATION**

Orderable Device	Status (1)	Package Type	Package Drawing	Pins	Package Qty	Eco Plan (2)	Lead/Ball Finish (6)	MSL Peak Temp (3)	Op Temp (°C)	Device Marking (4/5)	Samples
TLV2711CDBVR	ACTIVE	SOT-23	DBV	5	3000	Green (RoHS & no Sb/Br)	CU NIPDAU	Level-1-260C-UNLIM	0 to 70	VAJC	<a href="#">Samples</a>
TLV2711CDBVRG4	ACTIVE	SOT-23	DBV	5	3000	Green (RoHS & no Sb/Br)	CU NIPDAU	Level-1-260C-UNLIM	0 to 70	VAJC	<a href="#">Samples</a>
TLV2711CDBVT	ACTIVE	SOT-23	DBV	5	250	Green (RoHS & no Sb/Br)	CU NIPDAU	Level-1-260C-UNLIM		VAJC	<a href="#">Samples</a>
TLV2711IDBVR	ACTIVE	SOT-23	DBV	5	3000	Green (RoHS & no Sb/Br)	CU NIPDAU	Level-1-260C-UNLIM	-40 to 85	VAJI	<a href="#">Samples</a>
TLV2711IDBVRG4	ACTIVE	SOT-23	DBV	5	3000	Green (RoHS & no Sb/Br)	CU NIPDAU	Level-1-260C-UNLIM	-40 to 85	VAJI	<a href="#">Samples</a>
TLV2711IDBVT	ACTIVE	SOT-23	DBV	5	250	Green (RoHS & no Sb/Br)	CU NIPDAU	Level-1-260C-UNLIM		VAJI	<a href="#">Samples</a>
TLV2711IDBVTG4	ACTIVE	SOT-23	DBV	5	250	Green (RoHS & no Sb/Br)	CU NIPDAU	Level-1-260C-UNLIM		VAJI	<a href="#">Samples</a>

(1) The marketing status values are defined as follows:

**ACTIVE:** Product device recommended for new designs.

**LIFEBUY:** TI has announced that the device will be discontinued, and a lifetime-buy period is in effect.

**NRND:** Not recommended for new designs. Device is in production to support existing customers, but TI does not recommend using this part in a new design.

**PREVIEW:** Device has been announced but is not in production. Samples may or may not be available.

**OBSOLETE:** TI has discontinued the production of the device.

(2) **RoHS:** TI defines "RoHS" to mean semiconductor products that are compliant with the current EU RoHS requirements for all 10 RoHS substances, including the requirement that RoHS substance do not exceed 0.1% by weight in homogeneous materials. Where designed to be soldered at high temperatures, "RoHS" products are suitable for use in specified lead-free processes. TI may reference these types of products as "Pb-Free".

**RoHS Exempt:** TI defines "RoHS Exempt" to mean products that contain lead but are compliant with EU RoHS pursuant to a specific EU RoHS exemption.

**Green:** TI defines "Green" to mean the content of Chlorine (Cl) and Bromine (Br) based flame retardants meet JS709B low halogen requirements of <=100ppm threshold. Antimony trioxide based flame retardants must also meet the <=1000ppm threshold requirement.

(3) MSL, Peak Temp. - The Moisture Sensitivity Level rating according to the JEDEC industry standard classifications, and peak solder temperature.

(4) There may be additional marking, which relates to the logo, the lot trace code information, or the environmental category on the device.

(5) Multiple Device Markings will be inside parentheses. Only one Device Marking contained in parentheses and separated by a "-" will appear on a device. If a line is indented then it is a continuation of the previous line and the two combined represent the entire Device Marking for that device.

<sup>(6)</sup> Lead/Ball Finish - Orderable Devices may have multiple material finish options. Finish options are separated by a vertical ruled line. Lead/Ball Finish values may wrap to two lines if the finish value exceeds the maximum column width.

**Important Information and Disclaimer:** The information provided on this page represents TI's knowledge and belief as of the date that it is provided. TI bases its knowledge and belief on information provided by third parties, and makes no representation or warranty as to the accuracy of such information. Efforts are underway to better integrate information from third parties. TI has taken and continues to take reasonable steps to provide representative and accurate information but may not have conducted destructive testing or chemical analysis on incoming materials and chemicals. TI and TI suppliers consider certain information to be proprietary, and thus CAS numbers and other limited information may not be available for release.

In no event shall TI's liability arising out of such information exceed the total purchase price of the TI part(s) at issue in this document sold by TI to Customer on an annual basis.

**TAPE AND REEL INFORMATION**

**QUADRANT ASSIGNMENTS FOR PIN 1 ORIENTATION IN TAPE**

\*All dimensions are nominal

Device	Package Type	Package Drawing	Pins	SPQ	Reel Diameter (mm)	Reel Width W1 (mm)	A0 (mm)	B0 (mm)	K0 (mm)	P1 (mm)	W (mm)	Pin1 Quadrant
TLV2711CDBVR	SOT-23	DBV	5	3000	178.0	9.0	3.3	3.2	1.4	4.0	8.0	Q3
TLV2711CDBVT	SOT-23	DBV	5	250	178.0	9.0	3.3	3.2	1.4	4.0	8.0	Q3
TLV2711IDBVR	SOT-23	DBV	5	3000	178.0	9.0	3.3	3.2	1.4	4.0	8.0	Q3
TLV2711IDBVT	SOT-23	DBV	5	250	178.0	9.0	3.3	3.2	1.4	4.0	8.0	Q3

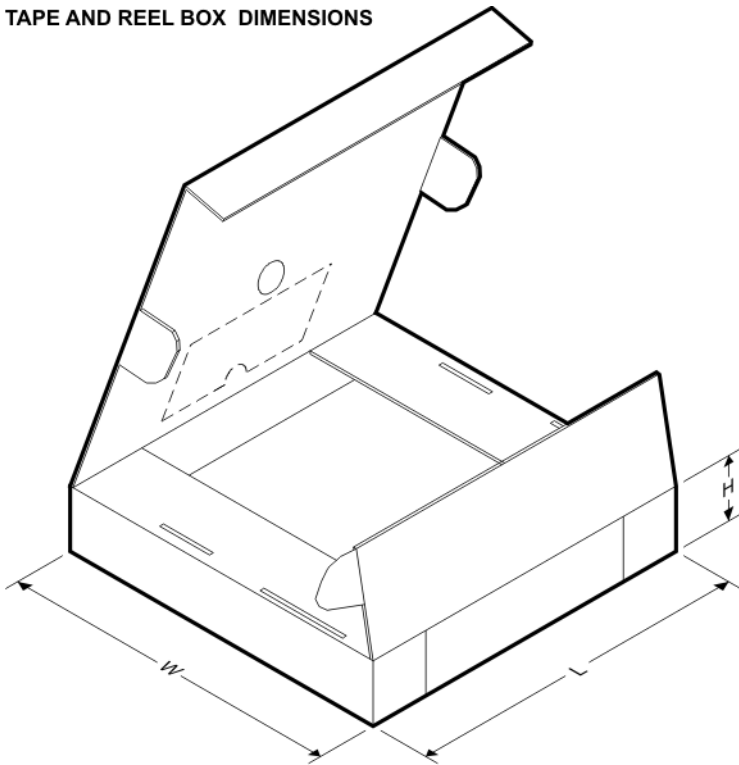
**TAPE AND REEL BOX DIMENSIONS**

\*All dimensions are nominal

Device	Package Type	Package Drawing	Pins	SPQ	Length (mm)	Width (mm)	Height (mm)
TLV2711CDBVR	SOT-23	DBV	5	3000	180.0	180.0	18.0
TLV2711CDBVT	SOT-23	DBV	5	250	180.0	180.0	18.0
TLV2711IDBVR	SOT-23	DBV	5	3000	180.0	180.0	18.0
TLV2711IDBVT	SOT-23	DBV	5	250	180.0	180.0	18.0

DBV0005A



# PACKAGE OUTLINE

SOT-23 - 1.45 mm max height

SMALL OUTLINE TRANSISTOR



4214839/D 11/2018

## NOTES:

1. All linear dimensions are in millimeters. Any dimensions in parenthesis are for reference only. Dimensioning and tolerancing per ASME Y14.5M.
2. This drawing is subject to change without notice.
3. Reference JEDEC MO-178.
4. Body dimensions do not include mold flash, protrusions, or gate burrs. Mold flash, protrusions, or gate burrs shall not exceed 0.15 mm per side.

# EXAMPLE BOARD LAYOUT

DBV0005A

SOT-23 - 1.45 mm max height

SMALL OUTLINE TRANSISTOR



LAND PATTERN EXAMPLE  
EXPOSED METAL SHOWN  
SCALE:15X



SOLDER MASK DETAILS

4214839/D 11/2018

NOTES: (continued)

- 5. Publication IPC-7351 may have alternate designs.
- 6. Solder mask tolerances between and around signal pads can vary based on board fabrication site.

# EXAMPLE STENCIL DESIGN

DBV0005A

SOT-23 - 1.45 mm max height

SMALL OUTLINE TRANSISTOR



SOLDER PASTE EXAMPLE  
BASED ON 0.125 mm THICK STENCIL  
SCALE:15X

4214839/D 11/2018

NOTES: (continued)

7. Laser cutting apertures with trapezoidal walls and rounded corners may offer better paste release. IPC-7525 may have alternate design recommendations.
8. Board assembly site may have different recommendations for stencil design.

## IMPORTANT NOTICE AND DISCLAIMER

TI PROVIDES TECHNICAL AND RELIABILITY DATA (INCLUDING DATASHEETS), DESIGN RESOURCES (INCLUDING REFERENCE DESIGNS), APPLICATION OR OTHER DESIGN ADVICE, WEB TOOLS, SAFETY INFORMATION, AND OTHER RESOURCES "AS IS" AND WITH ALL FAULTS, AND DISCLAIMS ALL WARRANTIES, EXPRESS AND IMPLIED, INCLUDING WITHOUT LIMITATION ANY IMPLIED WARRANTIES OF MERCHANTABILITY, FITNESS FOR A PARTICULAR PURPOSE OR NON-INFRINGEMENT OF THIRD PARTY INTELLECTUAL PROPERTY RIGHTS.

These resources are intended for skilled developers designing with TI products. You are solely responsible for (1) selecting the appropriate TI products for your application, (2) designing, validating and testing your application, and (3) ensuring your application meets applicable standards, and any other safety, security, or other requirements. These resources are subject to change without notice. TI grants you permission to use these resources only for development of an application that uses the TI products described in the resource. Other reproduction and display of these resources is prohibited. No license is granted to any other TI intellectual property right or to any third party intellectual property right. TI disclaims responsibility for, and you will fully indemnify TI and its representatives against, any claims, damages, costs, losses, and liabilities arising out of your use of these resources.

TI's products are provided subject to TI's Terms of Sale ([www.ti.com/legal/termsofsale.html](http://www.ti.com/legal/termsofsale.html)) or other applicable terms available either on [ti.com](http://ti.com) or provided in conjunction with such TI products. TI's provision of these resources does not expand or otherwise alter TI's applicable warranties or warranty disclaimers for TI products.

Mailing Address: Texas Instruments, Post Office Box 655303, Dallas, Texas 75265  
Copyright © 2019, Texas Instruments Incorporated

## Looking for pricing, stock, or lifecycle information?

Click below to explore more details on WIN SOURCE:

 [View TLV2711IDBVR on WIN SOURCE](#)

 [Texas Instruments](#) Information

## Optimize Your Supply Chain with WIN SOURCE Solutions

-  Global Sourcing Solution
-  Obsolete Management
-  Cost Control Management
-  Shortage Management
-  Alternative Solution
-  Excess Inventory Management