



# THE DATASHEET OF TLV4113ID



# TLV4110, TLV4111, TLV4112, TLV4113 FAMILY OF HIGH OUTPUT DRIVE OPERATIONAL AMPLIFIERS WITH SHUTDOWN

SLOS289E – DECEMBER 1999 – REVISED SEPTEMBER 2006

- High Output Drive . . . >300 mA
- Rail-To-Rail Output
- Unity-Gain Bandwidth . . . 2.7 MHz
- Slew Rate . . . 1.5 V/ $\mu$ s
- Supply Current . . . 700  $\mu$ A/Per Channel
- Supply Voltage Range . . . 2.5 V to 6 V
- Specified Temperature Range:
  - $T_A = 0^\circ\text{C}$  to  $70^\circ\text{C}$  . . . Commercial Grade
  - $T_A = -40^\circ\text{C}$  to  $125^\circ\text{C}$  . . . Industrial Grade
- Universal OpAmp EVM

Operational Amplifier

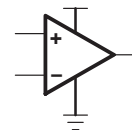

TLV4112  
D, DGN, OR P PACKAGE  
(TOP VIEW)

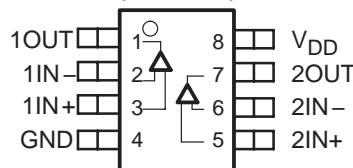

## description

The TLV411x single supply operational amplifiers provide output currents in excess of 300 mA at 5 V. This enables standard pin-out amplifiers to be used as high current buffers or in coil driver applications. The TLV4110 and TLV4113 come with a shutdown feature.

The TLV411x is available in the ultra small MSOP PowerPAD™ package, which offers the exceptional thermal impedance required for amplifiers delivering high current levels.

All TLV411x devices are offered in PDIP, SOIC (single and dual) and MSOP PowerPAD (dual).

FAMILY PACKAGE TABLE

| DEVICE  | NUMBER OF CHANNELS | PACKAGE TYPES |      |      | SHUTDOWN | UNIVERSAL EVM BOARD                             |
|---------|--------------------|---------------|------|------|----------|---|
|         |                    | MSOP          | PDIP | SOIC |          |   |
| TLV4110 | 1                  | 8             | 8    | 8    | Yes      | Refer to the EVM Selection Guide (Lit# SLOU060) |
| TLV4111 | 1                  | 8             | 8    | 8    | —        |   |
| TLV4112 | 2                  | 8             | 8    | 8    | —        |   |
| TLV4113 | 2                  | 10            | 14   | 14   | Yes      |   |

HIGH-LEVEL OUTPUT VOLTAGE  
vs  
HIGH-LEVEL OUTPUT CURRENT

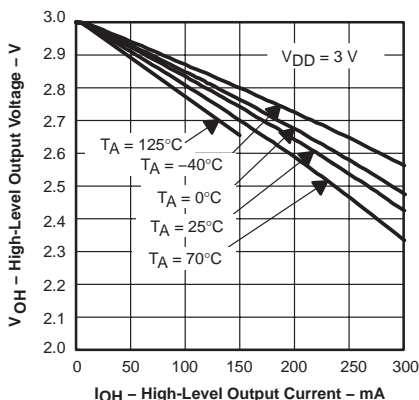

LOW-LEVEL OUTPUT VOLTAGE  
vs  
LOW-LEVEL OUTPUT CURRENT

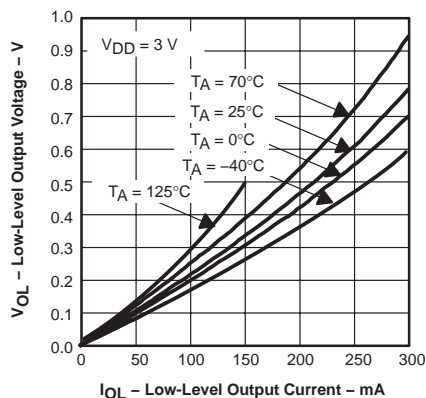

Please be aware that an important notice concerning availability, standard warranty, and use in critical applications of Texas Instruments semiconductor products and disclaimers thereto appears at the end of this data sheet.

PowerPAD is a trademark of Texas Instruments. All other trademarks are the property of their respective owners.

PRODUCTION DATA information is current as of publication date. Products conform to specifications per the terms of Texas Instruments standard warranty. Production processing does not necessarily include testing of all parameters.



POST OFFICE BOX 655303 • DALLAS, TEXAS 75265

Copyright © 1999–2006, Texas Instruments Incorporated

# TLV4110, TLV4111, TLV4112, TLV4113 FAMILY OF HIGH OUTPUT DRIVE OPERATIONAL AMPLIFIERS WITH SHUTDOWN

SLOS289E – DECEMBER 1999 – REVISED SEPTEMBER 2006

## TLV4110 AND TLV4111 AVAILABLE OPTIONS

| T <sub>A</sub> | PACKAGED DEVICES    |                      |         |                 |
|----------------|---------------------|----------------------|---------|-----------------|
|                | SMALL OUTLINE (D)†‡ | MSOP                 |         | PLASTIC DIP (P) |
|                |                     | SMALL OUTLINE (DGN)† | SYMBOL  |                 |
| 0°C to 70°C    | TLV4110CD           | TLV4110CDGN          | xxTIAHL | TLV4110CP       |
|                | TLV4111CD           | TLV4111CDGN          | xxTIAHN | TLV4111CP       |
| -40°C to 125°C | TLV4110ID           | TLV4110IDGN          | xxTIAHM | TLV4110IP       |
|                | TLV4111ID           | TLV4111IDGN          | xxTIAHO | TLV4111IP       |

† This package is available taped and reeled. To order this packaging option, add an R suffix to the part number (e.g., TLV4110CDR).

‡ In the SOIC package, the maximum RMS output power is thermally limited to 350 mW; 700 mW peaks can be driven, as long as the RMS value is less than 350 mW.

## TLV4112 AND TLV4113 AVAILABLE OPTIONS

| T <sub>A</sub> | PACKAGED DEVICES    |                      |         |                      |         |                 |
|----------------|---------------------|----------------------|---------|----------------------|---------|-----------------|
|                | SMALL OUTLINE (D)†‡ | MSOP                 |         |                      |         | PLASTIC DIP (P) |
|                |                     | SMALL OUTLINE (DGN)† | SYMBOL  | SMALL OUTLINE (DGQ)† | SYMBOL  |                 |
| 0°C to 70°C    | TLV4112CD           | TLV4112DGN           | xxTIAHP | —                    | —       | TLV4112CP       |
|                | TLV4113CD           | —                    | —       | TLV4113CDGQ          | xxTIAHR | TLV4113CN       |
| -40°C to 125°C | TLV4112ID           | TLV4112IDGN          | xxTIAHQ | —                    | —       | TLV4112IP       |
|                | TLV4113ID           | —                    | —       | TLV4113IDGQ          | xxTIAHS | TLV4113IN       |

† This package is available taped and reeled. To order this packaging option, add an R suffix to the part number (e.g., TLV4112CDR).

‡ In the SOIC package, the maximum RMS output power is thermally limited to 350 mW; 700 mW peaks can be driven, as long as the RMS value is less than 350 mW.

## TLV411x PACKAGE PIN OUTS

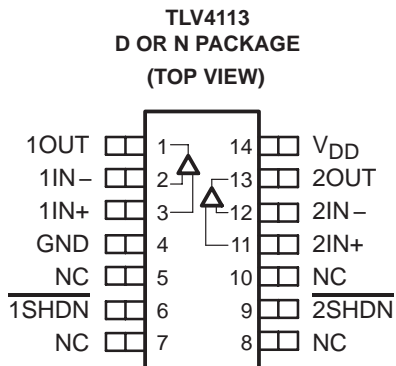
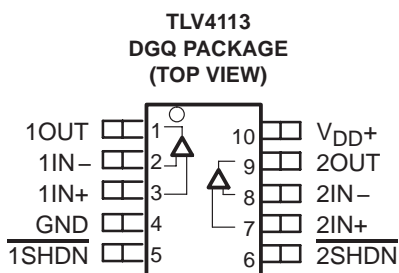
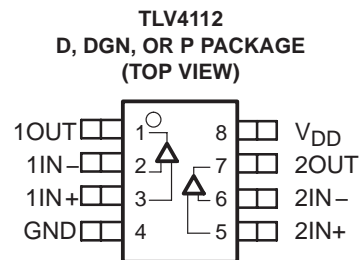
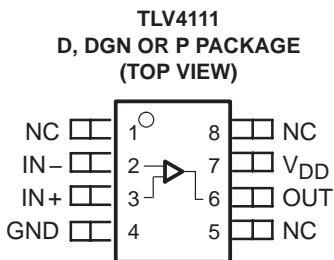
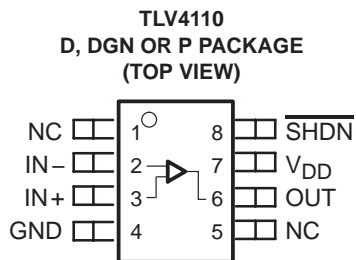

NC – No internal connection

# TLV4110, TLV4111, TLV4112, TLV4113 FAMILY OF HIGH OUTPUT DRIVE OPERATIONAL AMPLIFIERS WITH SHUTDOWN

SLOS289E – DECEMBER 1999 – REVISED SEPTEMBER 2006

## absolute maximum ratings over operating free-air temperature range (unless otherwise noted)†

|   |                              |
|---|------------------------------|
| Supply voltage, $V_{DD}$ (see Note 1)                             | 7 V                          |
| Differential input voltage, $V_{ID}$                              | $\pm V_{DD}$                 |
| Input voltage range, $V_I$  | $\pm V_{DD}$                 |
| Output current, $I_O$ (see Note 2)                                | 800 mA                       |
| Continuous /RMS output current, $I_O$ (each output of amplifier): |                              |
| $T_J \leq 105^\circ\text{C}$                                      | 350 mA                       |
| $T_J \leq 150^\circ\text{C}$                                      | 110 mA                       |
| Peak output current, $I_O$ (each output of amplifier):            |                              |
| $T_J \leq 105^\circ\text{C}$                                      | 500 mA                       |
| $T_J \leq 150^\circ\text{C}$                                      | 155 mA                       |
| Continuous total power dissipation                                | See Dissipation Rating Table |
| Operating free-air temperature range, $T_A$ :                     |                              |
| C suffix  | 0°C to 70°C                  |
| I suffix  | –40°C to 125°C               |
| Maximum junction temperature, $T_J$                               | 150°C                        |
| Storage temperature range, $T_{stg}$                              | –65°C to 150°C               |
| Lead temperature 1,6 mm (1/16 inch) from case for 10 seconds      | 260°C                        |

† Stresses beyond those listed under “absolute maximum ratings” may cause permanent damage to the device. These are stress ratings only, and functional operation of the device at these or any other conditions beyond those indicated under “recommended operating conditions” is not implied. Exposure to absolute-maximum-rated conditions for extended periods may affect device reliability.

- NOTES: 1. All voltage values, except differential voltages, are with respect to GND.  
2. To prevent permanent damage the die temperature must not exceed the maximum junction temperature.

**DISSIPATION RATING TABLE**

| PACKAGE   | $\theta_{JC}$<br>(°C/W) | $\theta_{JA}$<br>(°C/W) | $T_A \leq 25^\circ\text{C}$<br>POWER RATING | $T_A = 125^\circ\text{C}$<br>POWER RATING |
|-----------|-------------------------|-------------------------|---|---|
| D (8)     | 38.3                    | 176                     | 710 mW                                      | 142 mW                                    |
| D (14)    | 26.9                    | 122.3                   | 1022 mW                                     | 204.4 mW                                  |
| DGN (8)‡  | 4.7                     | 52.7                    | 2.37 W                                      | 474.4 mW                                  |
| DGQ (10)‡ | 4.7                     | 52.3                    | 2.39 W                                      | 478 mW                                    |
| P (8)     | 41                      | 104                     | 1200 mW                                     | 240.4 mW                                  |
| N (14)    | 32                      | 78                      | 1600 mW                                     | 320.5 mW                                  |

‡ See The Texas Instruments document, *PowerPAD Thermally Enhanced Package Application Report* (literature number SLMA002), for more information on the PowerPAD package. The thermal data was measured on a PCB layout based on the information in the section entitled *Texas Instruments Recommended Board for PowerPAD* on page 33 of the before mentioned document.

## recommended operating conditions

|  |          | MIN                   | MAX          | UNIT |
|--|----------|-----------------------|--------------|------|
| Supply voltage, $V_{DD}$                   |          | 2.5                   | 6            | V    |
| Common-mode input voltage range, $V_{ICR}$ |          | 0                     | $V_{DD}-1.5$ | V    |
| Operating free-air temperature, $T_A$      | C-suffix | 0                     | 70           | °C   |
|  | I-suffix | –40                   | 125          |      |
| Shutdown turn-on/off voltage level§        | V(on)    | $V_{DD} = 3\text{ V}$ | 2.1          | V    |
|  |          | $V_{DD} = 5\text{ V}$ | 3.8          |      |
|  | V(off)   | $V_{DD} = 3\text{ V}$ | 0.9          |      |
|  |          | $V_{DD} = 5\text{ V}$ | 1.65         |      |

§ Relative to GND



# TLV4110, TLV4111, TLV4112, TLV4113

## FAMILY OF HIGH OUTPUT DRIVE OPERATIONAL AMPLIFIERS WITH SHUTDOWN

SLOS289E – DECEMBER 1999 – REVISED SEPTEMBER 2006

electrical characteristics at recommend operating conditions,  $V_{DD} = 3\text{ V}$  and  $5\text{ V}$  (unless otherwise noted)

### dc performance

| PARAMETER       |   | TEST CONDITIONS  |   | $T_A^\dagger$ | MIN | TYP  | MAX | UNITS                        |
|-----------------|---|--|---|---------------|-----|------|-----|------------------------------|
| $V_{IO}$        | Input offset voltage                            | $V_{IC} = V_{DD}/2,$<br>$R_L = 100\ \Omega,$                   | $V_O = V_{DD}/2,$<br>$R_S = 50\ \Omega$ | 25°C          | 175 | 3500 |     | $\mu\text{V}$                |
|                 |   |  |   | Full range    |     | 4000 |     |                              |
| $\alpha V_{IO}$ | Offset voltage draft                            |  |   | 25°C          |     | 3    |     | $\mu\text{V}/^\circ\text{C}$ |
| CMRR            | Common-mode rejection ratio                     | $V_{DD} = 3\text{ V},$<br>$R_S = 50\ \Omega$                   | $V_{IC} = 0\text{ to }2\text{ V},$      | 25°C          |     | 63   |     | dB                           |
|                 |   |  | $V_{IC} = 0\text{ to }4\text{ V},$      | 25°C          |     | 68   |     |                              |
| $A_{VD}$        | Large-signal differential voltage amplification | $V_{DD} = 3\text{ V},$<br>$V_{O(PP)} = 0\text{ to }1\text{ V}$ | $R_L = 100\ \Omega$                     | 25°C          | 78  | 84   |     | dB                           |
|                 |   |  |   | Full range    |     | 67   |     |                              |
|                 |   |  | $R_L = 10\ \text{k}\Omega$              | 25°C          | 85  | 100  |     |                              |
|                 |   |  |   | Full range    |     | 75   |     |                              |
|                 |   | $V_{DD} = 5\text{ V},$<br>$V_{O(PP)} = 0\text{ to }3\text{ V}$ | $R_L = 100\ \Omega$                     | 25°C          | 88  | 94   |     |                              |
|                 |   |  |   | Full range    |     | 75   |     |                              |
|                 |   |  | $R_L = 10\ \text{k}\Omega$              | 25°C          | 90  | 110  |     |                              |
|                 |   |  |   | Full range    |     | 85   |     |                              |

$^\dagger$  Full range is 0°C to 70°C for C suffix and -40°C to 125°C for I suffix. If not specified, full range is -40°C to 125°C.

### input characteristics

| PARAMETER  |                               | TEST CONDITIONS                         |          | $T_A^\dagger$ | MIN | TYP  | MAX | UNITS            |
|------------|-------------------------------|---|----------|---------------|-----|------|-----|------------------|
| $I_{IO}$   | Input offset current          | $V_{IC} = V_{DD}/2$                     | TLV411xC | 25°C          | 0.3 | 25   |     | pA               |
|            |                               |   |          | Full range    |     | 50   |     |                  |
|            |                               |   | TLV411xI | Full range    |     | 250  |     |                  |
| $I_{IB}$   | Input bias current            | $V_O = V_{DD}/2,$<br>$R_S = 50\ \Omega$ | TLV411xC | 25°C          | 0.3 | 50   |     | pA               |
|            |                               |   |          | Full range    |     | 100  |     |                  |
|            |                               |   | TLV411xI | Full range    |     | 500  |     |                  |
| $r_{i(d)}$ | Differential input resistance |   |          | 25°C          |     | 1000 |     | $\text{G}\Omega$ |
| $C_{IC}$   | Common-mode input capacitance | $f = 100\ \text{Hz}$                    |          | 25°C          |     | 5    |     | pF               |

$^\dagger$  Full range is 0°C to 70°C for C suffix and -40°C to 125°C for I suffix. If not specified, full range is -40°C to 125°C.



# TLV4110, TLV4111, TLV4112, TLV4113 FAMILY OF HIGH OUTPUT DRIVE OPERATIONAL AMPLIFIERS WITH SHUTDOWN

SLOS289E – DECEMBER 1999 – REVISED SEPTEMBER 2006

electrical characteristics at specified free-air temperature,  $V_{DD} = 3\text{ V}$  and  $5\text{ V}$  (unless otherwise noted) (continued)

### output characteristics

| PARAMETER                              | TEST CONDITIONS   | $T_A$ †                   | MIN           | TYP  | MAX  | UNITS |
|--|---|---------------------------|---------------|------|------|-------|
| $V_{OH}$ High-level output voltage     | $V_{DD} = 3\text{ V}$ , $V_{IC} = V_{DD}/2$                     | $I_{OH} = -10\text{ mA}$  | 25°C          | 2.7  | 2.97 | V     |
|  |   |                           | Full range    | 2.7  |      |       |
|  |   | $I_{OH} = -100\text{ mA}$ | 25°C          | 2.6  | 2.73 |       |
|  |   |                           | Full range    | 2.6  |      |       |
|  | $V_{DD} = 5\text{ V}$ , $V_{IC} = V_{DD}/2$                     | $I_{OH} = -10\text{ mA}$  | 25°C          | 4.7  | 4.96 | V     |
|  |   |                           | Full range    | 4.7  |      |       |
|  |   | $I_{OH} = -100\text{ mA}$ | 25°C          | 4.6  | 4.76 |       |
|  |   |                           | Full range    | 4.6  |      |       |
| $I_{OH} = -200\text{ mA}$              | 25°C  | 4.45                      | 4.6           |      |      |       |
|  | -40°C to 85°C   | 4.35                      |               |      |      |       |
| $V_{OL}$ Low-level output voltage      | $V_{DD} = 3\text{ V}$ and $5\text{ V}$ ,<br>$V_{IC} = V_{DD}/2$ | $I_{OL} = 10\text{ mA}$   | 25°C          | 0.03 | 0.1  | V     |
|  |   |                           | Full range    |      | 0.1  |       |
|  |   | $I_{OL} = 100\text{ mA}$  | 25°C          | 0.33 | 0.4  |       |
|  |   |                           | Full range    |      | 0.55 |       |
|  | $V_{DD} = 5\text{ V}$ , $V_{IC} = V_{DD}/2$                     | $I_{OL} = 200\text{ mA}$  | 25°C          | 0.38 | 0.6  |       |
|  |   |                           | -40°C to 85°C |      | 0.7  |       |
| $I_O$ Output current‡                  | Measured at 0.5 V from rail                                     | $V_{DD} = 3\text{ V}$     | 25°C          | ±220 |      | mA    |
|  |   | $V_{DD} = 5\text{ V}$     |               | ±320 |      |       |
| $I_{OS}$ Short-circuit output current‡ | Sourcing  | 25°C                      | 800           |      | mA   |       |
|  | Sinking   |                           | 800           |      |      |       |

† Full range is 0°C to 70°C for C suffix and -40°C to 125°C for I suffix. If not specified, full range is -40°C to 125°C.

‡ When driving output currents in excess of 200 mA, the MSOP PowerPAD package is required for thermal dissipation.

### power supply

| PARAMETER   | TEST CONDITIONS  | $T_A$      | MIN | TYP | MAX  | UNITS |
|---|--|------------|-----|-----|------|-------|
| $I_{DD}$ Supply current (per channel)                                 | $V_O = V_{DD}/2$   | 25°C       |     | 700 | 1000 | μA    |
|   |  | Full range |     |     | 1500 |       |
| PSRR Power supply rejection ratio ( $\Delta V_{DD} / \Delta V_{IO}$ ) | $V_{DD} = 2.7\text{ to }3.3\text{ V}$ , No load,<br>$V_{IC} = V_{DD}/2\text{ V}$ | 25°C       | 70  | 82  | dB   |       |
|   |  | Full range | 65  |     |      |       |
|   | $V_{DD} = 4.5\text{ to }5.5\text{ V}$ , No load,<br>$V_{IC} = V_{DD}/2\text{ V}$ | 25°C       | 70  | 79  |      |       |
|   |  | Full range | 65  |     |      |       |

† Full range is 0°C to 70°C for C suffix and -40°C to 125°C for I suffix. If not specified, full range is -40°C to 125°C.



# TLV4110, TLV4111, TLV4112, TLV4113

## FAMILY OF HIGH OUTPUT DRIVE OPERATIONAL AMPLIFIERS WITH SHUTDOWN

SLOS289E – DECEMBER 1999 – REVISED SEPTEMBER 2006

electrical characteristics at specified free-air temperature,  $V_{DD} = 3\text{ V}$  and  $5\text{ V}$  (unless otherwise noted) (continued)

### dynamic performance

| PARAMETER |                         | TEST CONDITIONS  |                       | $T_A^\dagger$ | MIN   | TYP  | MAX              | UNITS |
|-----------|-------------------------|--|-----------------------|---------------|-------|------|------------------|-------|
| GBWP      | Gain bandwidth product  | $R_L = 100\ \Omega$  | $C_L = 10\ \text{pF}$ | 25°C          |       | 2.7  |                  | MHz   |
| SR        | Slew rate at unity gain | $V_{O(pp)} = 2\text{ V}$ ,<br>$R_L = 100\ \Omega$ ,<br>$C_L = 10\ \text{pF}$                           | $V_{DD} = 3\text{ V}$ | 25°C          | 0.8   | 1.57 | V/ $\mu\text{s}$ |       |
|           |                         |  |                       | Full range    | 0.55  |      |                  |       |
|           |                         |  | $V_{DD} = 5\text{ V}$ | 25°C          | 1     | 1.57 |                  |       |
|           |                         |  |                       | Full range    | 0.7   |      |                  |       |
| $\phi_M$  | Phase margin            | $R_L = 100\ \Omega$ ,  | $C_L = 10\ \text{pF}$ | 25°C          | 66    |      |                  |       |
|           | Gain margin             |  |                       |               | 16    |      | dB               |       |
| $t_s$     | Settling time           | $V(\text{STEP})_{pp} = 1\text{ V}$ ,<br>$A_V = -1$ ,<br>$C_L = 10\ \text{pF}$ ,<br>$R_L = 100\ \Omega$ | 0.1%                  | 25°C          | 0.7   |      | $\mu\text{s}$    |       |
|           |                         |  |                       |               | 0.01% | 1.3  |                  |       |

$^\dagger$  Full range is 0°C to 70°C for C suffix and -40°C to 125°C for I suffix. If not specified, full range is -40°C to 125°C.

### noise/distortion performance

| PARAMETER |                                      | TEST CONDITIONS  |                      | $T_A$ | MIN   | TYP | MAX                    | UNITS |
|-----------|--------------------------------------|--|----------------------|-------|-------|-----|------------------------|-------|
| THD+N     | Total harmonic distortion plus noise | $V_{O(pp)} = V_{DD}/2\text{ V}$ ,<br>$R_L = 100\ \Omega$ ,<br>$f = 100\ \text{Hz}$ | $A_V = 1$            | 25°C  | 0.025 |     |                        |       |
|           |                                      |  | $A_V = 10$           |       | 0.035 |     |                        |       |
|           |                                      |  | $A_V = 100$          |       | 0.15  |     |                        |       |
| $V_n$     | Equivalent input noise voltage       | $f = 100\ \text{Hz}$   | $f = 10\ \text{kHz}$ | 25°C  | 55    |     | nV/ $\sqrt{\text{Hz}}$ |       |
|           |                                      |  |                      |       | 10    |     |                        |       |
| $I_n$     | Equivalent input noise current       | $f = 1\ \text{kHz}$  |                      | 25°C  | 0.31  |     | fA/ $\sqrt{\text{Hz}}$ |       |

### shutdown characteristics

| PARAMETER             |  | TEST CONDITIONS                       |  | $T_A^\dagger$ | MIN | TYP | MAX           | UNITS |
|-----------------------|--|---------------------------------------|--|---------------|-----|-----|---------------|-------|
| $I_{DD}(\text{SHDN})$ | Supply current in shutdown mode (per channel) (TLV4110, TLV4113) | $\overline{\text{SHDN}} = 0\text{ V}$ |  | 25°C          | 3.4 | 10  | $\mu\text{A}$ |       |
|                       |  |                                       |  | Full range    |     | 15  |               |       |
| $t(\text{ON})$        | Amplifier turn-on time $^\ddagger$                               | $R_L = 100\ \Omega$                   |  | 25°C          | 1   |     | $\mu\text{s}$ |       |
| $t(\text{Off})$       | Amplifier turn-off time $^\ddagger$                              |                                       |  |               | 3.3 |     |               |       |

$^\dagger$  Full range is 0°C to 70°C for C suffix and -40°C to 125°C for I suffix. If not specified, full range is -40°C to 125°C.

$^\ddagger$  Disable time and enable time are defined as the interval between application of the logic signal to SHDN and the point at which the supply current has reached half its final value.

**TLV4110, TLV4111, TLV4112, TLV4113**  
**FAMILY OF HIGH OUTPUT DRIVE OPERATIONAL**  
**AMPLIFIERS WITH SHUTDOWN**

SLOS289E – DECEMBER 1999 – REVISED SEPTEMBER 2006

**TYPICAL CHARACTERISTICS**

**Table of Graphs**

|          |  |                              | <b>FIGURE</b> |
|----------|--|------------------------------|---------------|
| $V_{IO}$ | Input offset voltage                         | vs Common-mode input voltage | 1, 2          |
| CMRR     | Common-mode rejection ratio                  | vs Frequency                 | 3             |
| $V_{OH}$ | High-level output voltage                    | vs High-level output current | 4, 6          |
| $V_{OL}$ | Low-level output voltage                     | vs Low-level output current  | 5, 7          |
| $Z_o$    | Output impedance                             | vs Frequency                 | 8             |
| $I_{DD}$ | Supply current                               | vs Supply voltage            | 9             |
| kSVR     | Power supply voltage rejection ratio         | vs Frequency                 | 10            |
| $A_{VD}$ | Differential voltage amplification and phase | vs Frequency                 | 11            |
|          | Gain-bandwidth product                       | vs Supply voltage            | 12            |
| SR       | Slew rate                                    | vs Supply voltage            | 13            |
|          |  | vs Temperature               | 14            |
|          | Total harmonic distortion+noise              | vs Frequency                 | 15            |
| $V_n$    | Equivalent input voltage noise               | vs Frequency                 | 16            |
|          | Phase margin                                 | vs Capacitive load           | 17            |
|          | Voltage-follower signal pulse response       |                              | 18, 19        |
|          | Inverting large-signal pulse response        |                              | 20, 21        |
|          | Small-signal inverting pulse response        |                              | 22            |
|          | Crosstalk                                    | vs Frequency                 | 23            |
|          | Shutdown forward and reverse isolation       |                              | 24            |
|          | Shutdown supply current                      | vs Free-air temperature      | 25            |
|          | Shutdown supply current/output voltage       |                              | 26            |

# TLV4110, TLV4111, TLV4112, TLV4113

## FAMILY OF HIGH OUTPUT DRIVE OPERATIONAL AMPLIFIERS WITH SHUTDOWN

SLOS289E – DECEMBER 1999 – REVISED SEPTEMBER 2006

### TYPICAL CHARACTERISTICS

**INPUT OFFSET VOLTAGE  
vs  
COMMON-MODE INPUT VOLTAGE**

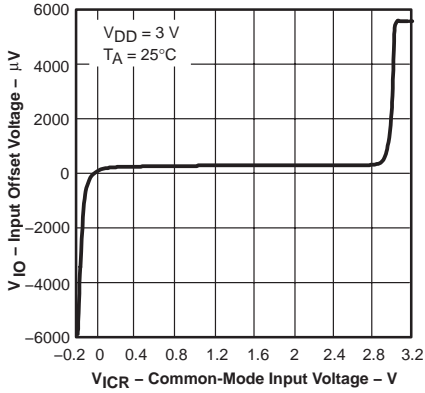

Figure 1

**INPUT OFFSET VOLTAGE  
vs  
COMMON-MODE INPUT VOLTAGE**

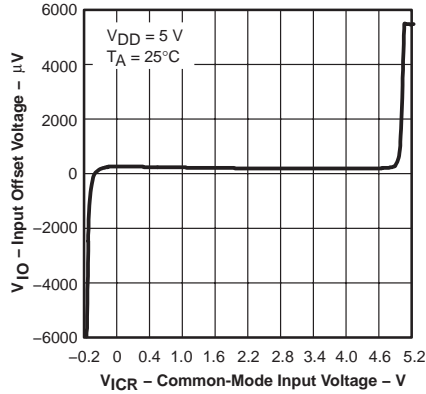

Figure 2

**COMMON-MODE REJECTION RATIO  
vs  
FREQUENCY**

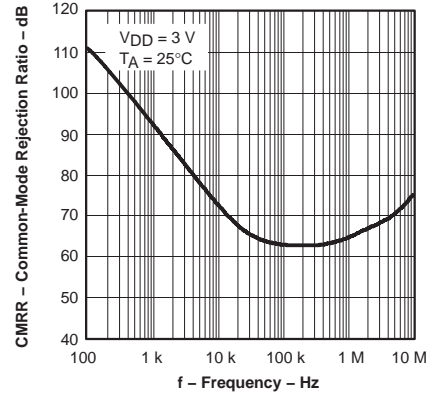

Figure 3

**HIGH-LEVEL OUTPUT VOLTAGE  
vs  
HIGH-LEVEL OUTPUT CURRENT**

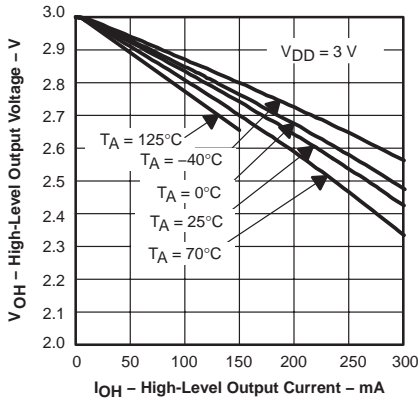

Figure 4

**LOW-LEVEL OUTPUT VOLTAGE  
vs  
LOW-LEVEL OUTPUT CURRENT**

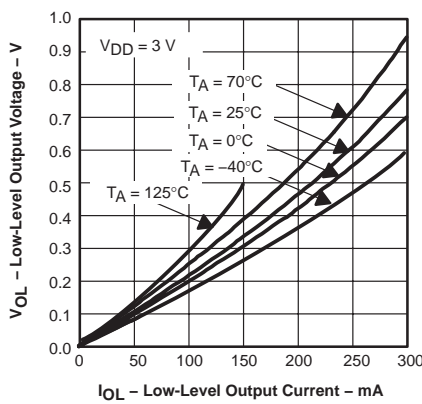

Figure 5

**HIGH-LEVEL OUTPUT VOLTAGE  
vs  
HIGH-LEVEL OUTPUT CURRENT**

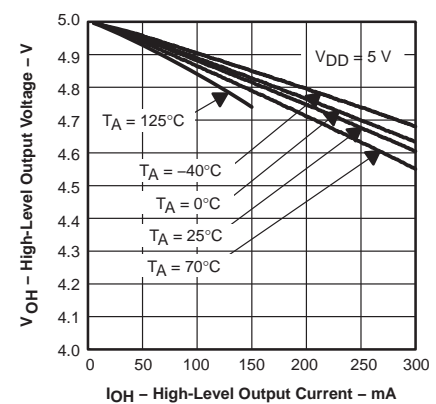

Figure 6

**LOW-LEVEL OUTPUT VOLTAGE  
vs  
LOW-LEVEL OUTPUT CURRENT**

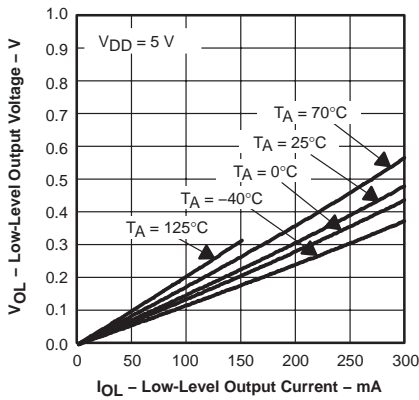

Figure 7

**OUTPUT IMPEDANCE  
vs  
FREQUENCY**

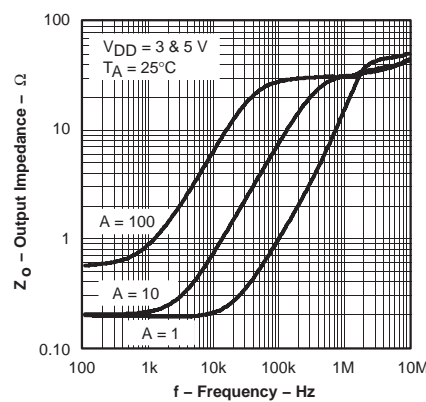

Figure 8

**SUPPLY CURRENT  
vs  
SUPPLY VOLTAGE**

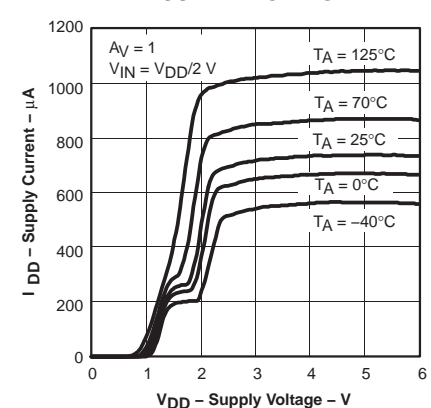

Figure 9



TYPICAL CHARACTERISTICS

POWER SUPPLY REJECTION RATIO  
 VS  
 FREQUENCY

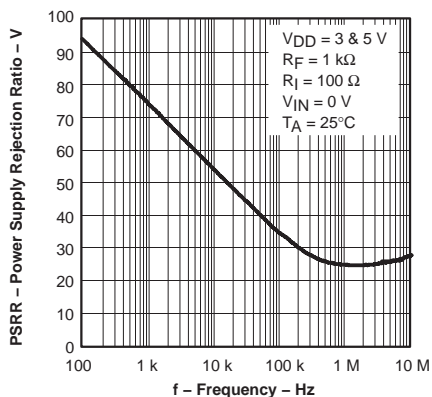

Figure 10

DIFFERENTIAL VOLTAGE  
 AMPLIFICATION AND PHASE  
 VS  
 FREQUENCY

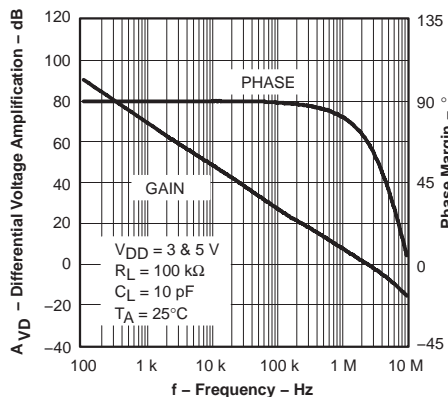

Figure 11

GAIN-BANDWIDTH PRODUCT  
 VS  
 SUPPLY VOLTAGE

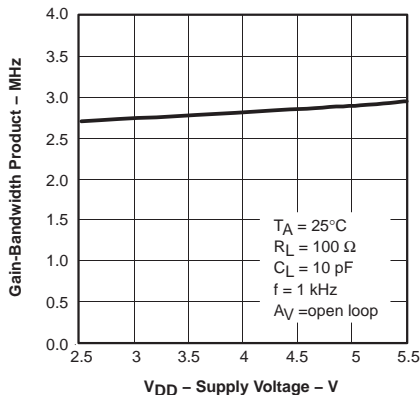

Figure 12

SLEW RATE  
 VS  
 SUPPLY VOLTAGE

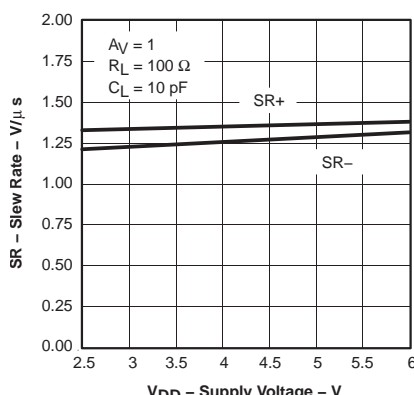

Figure 13

SLEW RATE  
 VS  
 TEMPERATURE

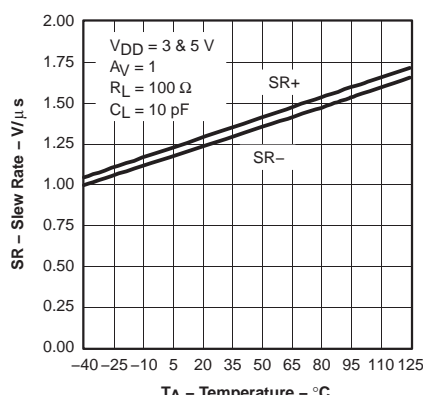

Figure 14

TOTAL HARMONIC DISTORTION+NOISE  
 VS  
 FREQUENCY

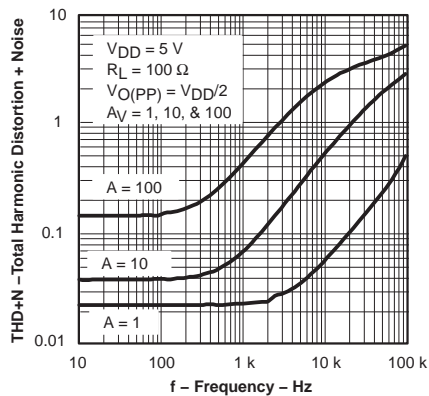

Figure 15

EQUIVALENT INPUT VOLTAGE NOISE  
 VS  
 FREQUENCY

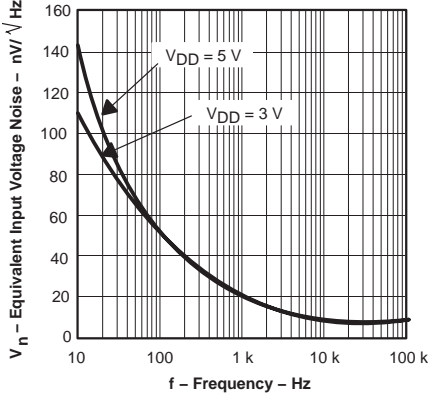

Figure 16

PHASE MARGIN  
 VS  
 CAPACITIVE LOAD

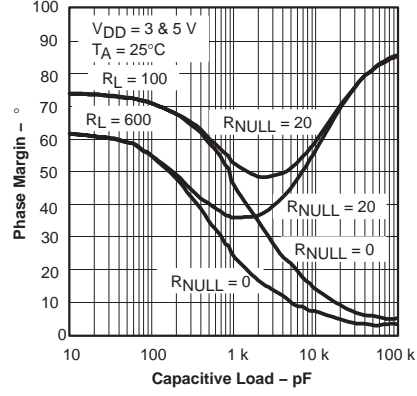

Figure 17

# TLV4110, TLV4111, TLV4112, TLV4113 FAMILY OF HIGH OUTPUT DRIVE OPERATIONAL AMPLIFIERS WITH SHUTDOWN

SLOS289E – DECEMBER 1999 – REVISED SEPTEMBER 2006

## TYPICAL CHARACTERISTICS

**VOLTAGE-FOLLOWER  
LARGE-SIGNAL PULSE RESPONSE**

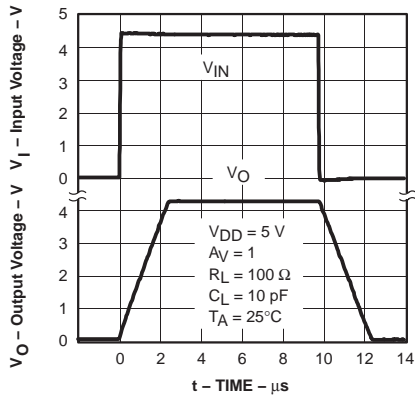

Figure 18

**VOLTAGE-FOLLOWER  
SMALL-SIGNAL PULSE RESPONSE**

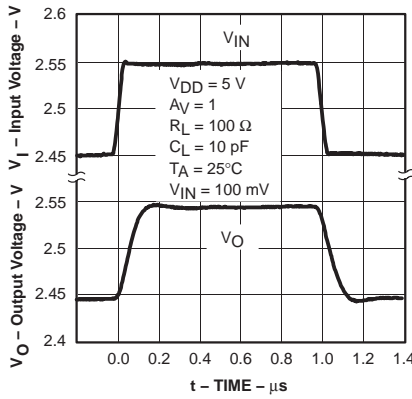

Figure 19

**INVERTING LARGE-SIGNAL  
PULSE RESPONSE**

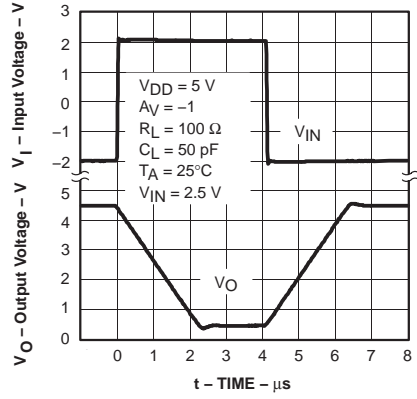

Figure 20

**INVERTING LARGE-SIGNAL  
PULSE RESPONSE**

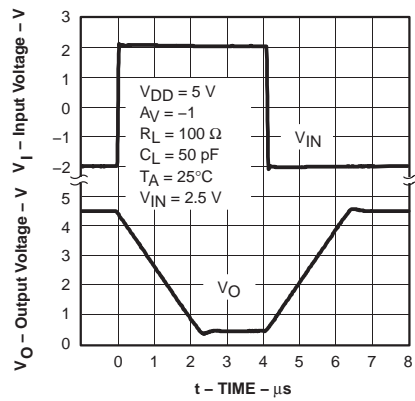

Figure 21

**SMALL-SIGNAL INVERTING  
PULSE RESPONSE**

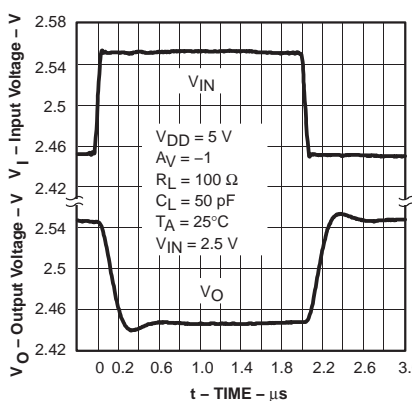

Figure 22

**CROSSTALK  
vs  
FREQUENCY**

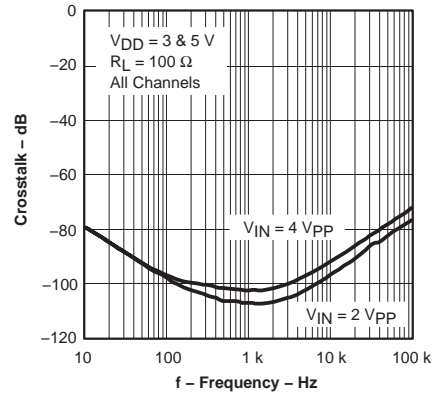

Figure 23

**SHUTDOWN FORWARD AND  
REVERSE ISOLATION**

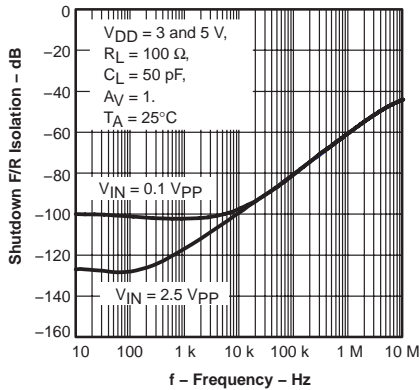

Figure 24

**SHUTDOWN SUPPLY CURRENT  
vs  
FREE-AIR TEMPERATURE**

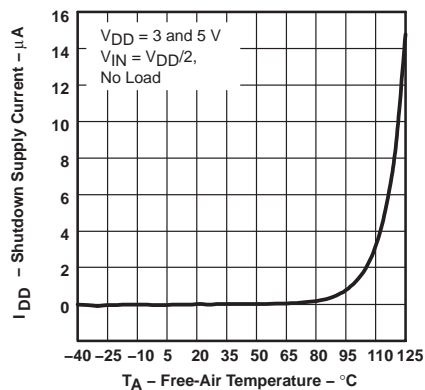

Figure 25

TYPICAL CHARACTERISTICS

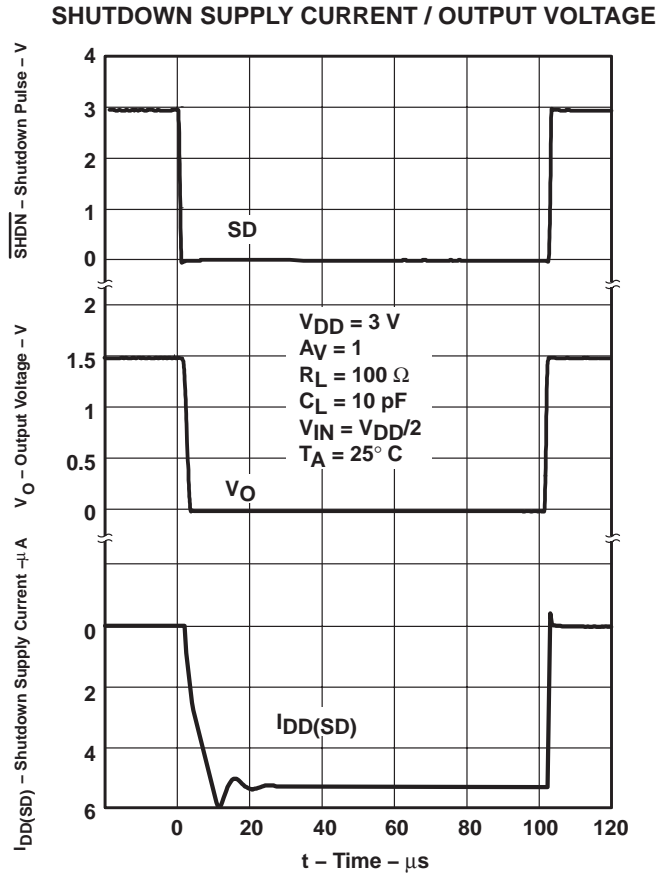

Figure 26

# TLV4110, TLV4111, TLV4112, TLV4113 FAMILY OF HIGH OUTPUT DRIVE OPERATIONAL AMPLIFIERS WITH SHUTDOWN

SLOS289E – DECEMBER 1999 – REVISED SEPTEMBER 2006

## APPLICATION INFORMATION

### shutdown function

Two members of the TLV411x family (TLV4110/3) have a shutdown terminal for conserving battery life in portable applications. When the shutdown terminal is tied low, the supply current is reduced to just nano amps per channel, the amplifier is disabled, and the outputs are placed in a high impedance mode. In order to save power in shutdown mode, an external pullup resistor is required, therefore, to enable the amplifier the shutdown terminal must be pulled high. When the shutdown terminal is left floating, care should be taken to ensure that parasitic leakage current at the shutdown terminal does not inadvertently place the operational amplifier into shutdown.

### driving a capacitive load

When the amplifier is configured in this manner, capacitive loading directly on the output will decrease the device's phase margin leading to high frequency ringing or oscillations. Therefore, for capacitive loads of greater than 1 nF, it is recommended that a resistor be placed in series ( $R_{NULL}$ ) with the output of the amplifier, as shown in Figure 27. A maximum value of 20  $\Omega$  should work well for most applications.

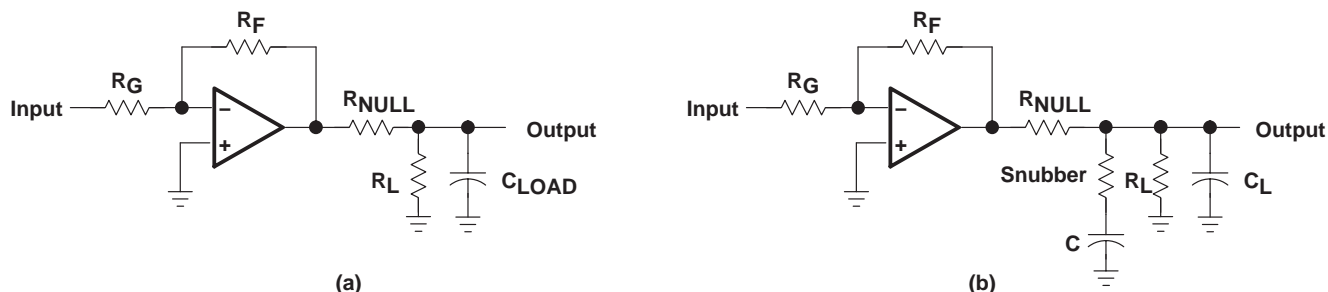

Figure 27. Driving a Capacitive Load

### offset voltage

The output offset voltage, ( $V_{OO}$ ) is the sum of the input offset voltage ( $V_{IO}$ ) and both input bias currents ( $I_{IB}$ ) times the corresponding gains. The following schematic and formula can be used to calculate the output offset voltage:

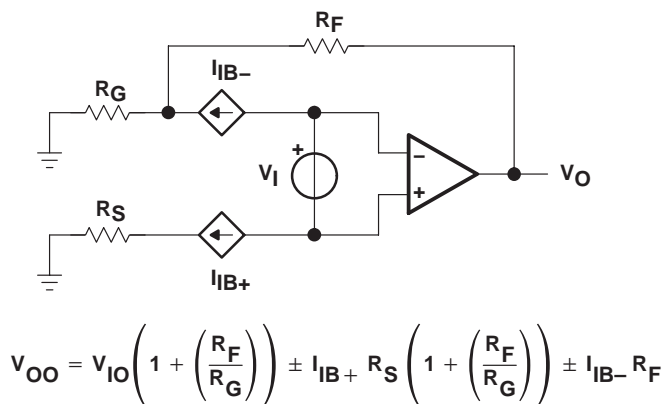

Figure 28. Output Offset Voltage Model

APPLICATION INFORMATION

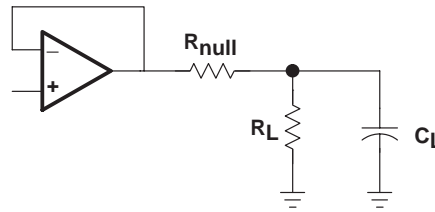

Figure 29

general power design considerations

When driving heavy loads at high junction temperatures there is an increased probability of electromigration affecting the long term reliability of ICs. Therefore for this not to be an issue either:

- The output current must be limited (at these high junction temperatures).
- or
- The junction temperature must be limited.

The maximum continuous output current at a die temperature 150°C will be 1/3 of the current at 105°C.

The junction temperature will be dependent on the ambient temperature around the IC, thermal impedance from the die to the ambient and power dissipated within the IC.

$$T_J = T_A + \theta_{JA} \times P_{DIS}$$

Where:

$P_{DIS}$  is the IC power dissipation and is equal to the output current multiplied by the voltage dropped across the output of the IC.

$\theta_{JA}$  is the thermal impedance between the junction and the ambient temperature of the IC.

$T_J$  is the junction temperature.

$T_A$  is the ambient temperature.

Reducing one or more of these factors results in a reduced die temperature. The 8-pin SOIC (small outline integrated circuit) has a thermal impedance from junction to ambient of 176°C/W. For this reason it is recommended that the maximum power dissipation of the 8-pin SOIC package be limited to 350 mW, with peak dissipation of 700 mW as long as the RMS value is less than 350 mW.

The use of the MSOP PowerPAD™ dramatically reduces the thermal impedance from junction to case. And with correct mounting, the reduced thermal impedance greatly increases the IC's permissible power dissipation and output current handling capability. For example, the power dissipation of the PowerPAD™ is increased to above 1 W. Sinusoidal and pulse-width modulated output signals also increase the output current capability. The equivalent dc current is proportional to the square-root of the duty cycle:

$$I_{DC(EQ)} = I_{Cont} \times \sqrt{\text{duty cycle}}$$

| CURRENT DUTY CYCLE AT PEAK RATED CURRENT | EQUIVALENT DC CURRENT AS A PERCENTAGE OF PEAK |
|--|---|
| 100                                      | 100   |
| 70                                       | 84  |
| 50                                       | 71  |

Note that with an operational amplifier, a duty cycle of 70% would often result in the op amp sourcing current 70% of the time and sinking current 30%, therefore, the equivalent dc current would still be 0.84 times the continuous current rating at a particular junction temperature.

# TLV4110, TLV4111, TLV4112, TLV4113 FAMILY OF HIGH OUTPUT DRIVE OPERATIONAL AMPLIFIERS WITH SHUTDOWN

SLOS289E – DECEMBER 1999 – REVISED SEPTEMBER 2006

## APPLICATION INFORMATION

### general PowerPAD design considerations

The TLV411x is available in a thermally-enhanced PowerPAD family of packages. These packages are constructed using a downset leadframe upon which the die is mounted [see Figure 30(a) and Figure 30(b)]. This arrangement results in the lead frame being exposed as a thermal pad on the underside of the package [see Figure 30(c)]. Because this thermal pad has direct thermal contact with the die, excellent thermal performance can be achieved by providing a good thermal path away from the thermal pad.

The PowerPAD package allows for both assembly and thermal management in one manufacturing operation. During the surface-mount solder operation (when the leads are being soldered), the thermal pad must be soldered to a copper area underneath the package. Through the use of thermal paths within this copper area, heat can be conducted away from the package into either a ground plane or other heat dissipating device.

Soldering the PowerPAD to the PCB is always recommended, even with applications that have low-power dissipation. This provides the necessary thermal and mechanical connection between the lead frame die pad and the PCB.

The PowerPAD package represents a breakthrough in combining the small area and ease of assembly of surface mount with mechanical methods of heatsinking.

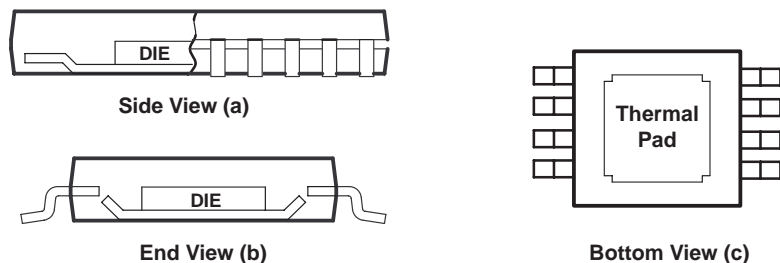

NOTE A: The thermal pad is electrically isolated from all terminals in the package.

**Figure 30. Views of Thermally-Enhanced DGN Package**

## APPLICATION INFORMATION

Although there are many ways to properly heatsink the PowerPAD package, the following steps illustrate the recommended approach.

### general PowerPAD design considerations (continued)

1. The thermal pad must be connected to the most negative supply voltage on the device, GND.
2. Prepare the PCB with a top side etch pattern as illustrated in the thermal land pattern mechanical drawings at the end of this document. There should be etch for the leads as well as etch for the thermal pad.
3. Place five holes in the area of the thermal pad. These holes should be 13 mils in diameter. Keep them small so that solder wicking through the holes is not a problem during reflow.
4. Additional vias may be placed anywhere along the thermal plane outside of the thermal pad area. This helps dissipate the heat generated by the TLV411x IC. These additional vias may be larger than the 13-mil diameter vias directly under the thermal pad. They can be larger because they are not in the thermal pad area to be soldered so that wicking is not a problem.
5. Connect all holes to the internal ground plane that is at the same voltage potential as the device GND pin.
6. When connecting these holes to the ground plane, do not use the typical web or spoke via connection methodology. Web connections have a high thermal resistance connection that is useful for slowing the heat transfer during soldering operations. This makes the soldering of vias that have plane connections easier. In this application, however, low thermal resistance is desired for the most efficient heat transfer. Therefore, the holes under the TLV411x PowerPAD package should make their connection to the internal ground plane with a complete connection around the entire circumference of the plated-through hole.
7. The top-side solder mask should leave the terminals of the package and the thermal pad area with its five holes exposed. The bottom-side solder mask should cover the five holes of the thermal pad area. This prevents solder from being pulled away from the thermal pad area during the reflow process.
8. Apply solder paste to the exposed thermal pad area and all of the IC terminals.
9. With these preparatory steps in place, the TLV411x IC is simply placed in position and run through the solder reflow operation as any standard surface-mount component. This results in a part that is properly installed.

For a given  $\theta_{JA}$ , the maximum power dissipation is shown in Figure 31 and is calculated by the following formula:

$$P_D = \left( \frac{T_{MAX} - T_A}{\theta_{JA}} \right)$$

Where:

$P_D$  = Maximum power dissipation of TLV411x IC (watts)

$T_{MAX}$  = Absolute maximum junction temperature (150°C)

$T_A$  = Free-ambient air temperature (°C)

$\theta_{JA}$  =  $\theta_{JC} + \theta_{CA}$

$\theta_{JC}$  = Thermal coefficient from junction to case

$\theta_{CA}$  = Thermal coefficient from case to ambient air (°C/W)

**TLV4110, TLV4111, TLV4112, TLV4113**  
**FAMILY OF HIGH OUTPUT DRIVE OPERATIONAL**  
**AMPLIFIERS WITH SHUTDOWN**

SLOS289E – DECEMBER 1999 – REVISED SEPTEMBER 2006

**APPLICATION INFORMATION**

**general PowerPAD design considerations (continued)**

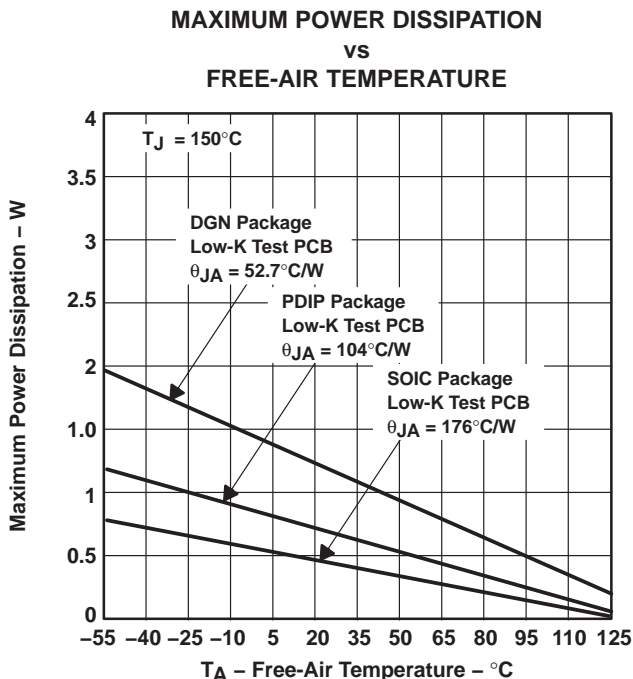

NOTE A: Results are with no air flow and using JEDEC Standard Low-K test PCB.

**Figure 31. Maximum Power Dissipation vs Free-Air Temperature**

The next consideration is the package constraints. The two sources of heat within an amplifier are quiescent power and output power. The designer should never forget about the quiescent heat generated within the device, especially multi-amplifier devices. Because these devices have linear output stages (Class A-B), most of the heat dissipation is at low output voltages with high output currents.

The other key factor when dealing with power dissipation is how the devices are mounted on the PCB. The PowerPAD devices are extremely useful for heat dissipation. But, the device should always be soldered to a copper plane to fully use the heat dissipation properties of the PowerPAD. The SOIC package, on the other hand, is highly dependent on how it is mounted on the PCB. As more trace and copper area is placed around the device,  $\theta_{JA}$  decreases and the heat dissipation capability increases. The currents and voltages shown in these graphs are for the total package. For the dual amplifier packages, the sum of the RMS output currents and voltages should be used to choose the proper package.



**PACKAGING INFORMATION**

| Orderable Device | Status<br>(1) | Package Type  | Package Drawing | Pins | Package Qty | Eco Plan<br>(2)         | Lead/Ball Finish<br>(6)    | MSL Peak Temp<br>(3) | Op Temp (°C) | Device Marking<br>(4/5) | Samples                 |
|------------------|---------------|---------------|-----------------|------|-------------|-------------------------|----------------------------|----------------------|--------------|-------------------------|-------------------------|
| TLV4110ID        | ACTIVE        | SOIC          | D               | 8    | 75          | Green (RoHS & no Sb/Br) | CU NIPDAU                  | Level-1-260C-UNLIM   | -40 to 125   | 4110I                   | <a href="#">Samples</a> |
| TLV4110IDG4      | ACTIVE        | SOIC          | D               | 8    | 75          | Green (RoHS & no Sb/Br) | CU NIPDAU                  | Level-1-260C-UNLIM   | -40 to 125   | 4110I                   | <a href="#">Samples</a> |
| TLV4110IDGNR     | ACTIVE        | MSOP-PowerPAD | DGN             | 8    | 2500        | Green (RoHS & no Sb/Br) | CU NIPDAU                  | Level-1-260C-UNLIM   | -40 to 125   | AHM                     | <a href="#">Samples</a> |
| TLV4110IDR       | ACTIVE        | SOIC          | D               | 8    | 2500        | Green (RoHS & no Sb/Br) | CU NIPDAU                  | Level-1-260C-UNLIM   | -40 to 125   | 4110I                   | <a href="#">Samples</a> |
| TLV4110IP        | ACTIVE        | PDIP          | P               | 8    | 50          | Green (RoHS & no Sb/Br) | CU NIPDAU                  | N / A for Pkg Type   | -40 to 125   | TLV4110I                | <a href="#">Samples</a> |
| TLV4111CD        | ACTIVE        | SOIC          | D               | 8    | 75          | Green (RoHS & no Sb/Br) | CU NIPDAU                  | Level-1-260C-UNLIM   | 0 to 70      | 4111C                   | <a href="#">Samples</a> |
| TLV4111CDGN      | ACTIVE        | MSOP-PowerPAD | DGN             | 8    | 80          | Green (RoHS & no Sb/Br) | CU NIPDAU                  | Level-1-260C-UNLIM   | 0 to 70      | AHN                     | <a href="#">Samples</a> |
| TLV4111ID        | ACTIVE        | SOIC          | D               | 8    | 75          | Green (RoHS & no Sb/Br) | CU NIPDAU                  | Level-1-260C-UNLIM   | -40 to 125   | 4111I                   | <a href="#">Samples</a> |
| TLV4111IDG4      | ACTIVE        | SOIC          | D               | 8    | 75          | Green (RoHS & no Sb/Br) | CU NIPDAU                  | Level-1-260C-UNLIM   | -40 to 125   | 4111I                   | <a href="#">Samples</a> |
| TLV4111IDGN      | ACTIVE        | MSOP-PowerPAD | DGN             | 8    | 80          | Green (RoHS & no Sb/Br) | CU NIPDAU                  | Level-1-260C-UNLIM   | -40 to 125   | AHO                     | <a href="#">Samples</a> |
| TLV4111IDGNR     | ACTIVE        | MSOP-PowerPAD | DGN             | 8    | 2500        | Green (RoHS & no Sb/Br) | CU NIPDAU                  | Level-1-260C-UNLIM   | -40 to 125   | AHO                     | <a href="#">Samples</a> |
| TLV4111IDGNRG4   | ACTIVE        | MSOP-PowerPAD | DGN             | 8    | 2500        | Green (RoHS & no Sb/Br) | CU NIPDAU                  | Level-1-260C-UNLIM   | -40 to 125   | AHO                     | <a href="#">Samples</a> |
| TLV4111IDR       | ACTIVE        | SOIC          | D               | 8    | 2500        | Green (RoHS & no Sb/Br) | CU NIPDAU                  | Level-1-260C-UNLIM   | -40 to 125   | 4111I                   | <a href="#">Samples</a> |
| TLV4112CD        | ACTIVE        | SOIC          | D               | 8    | 75          | Green (RoHS & no Sb/Br) | CU NIPDAU                  | Level-1-260C-UNLIM   | 0 to 70      | 4112C                   | <a href="#">Samples</a> |
| TLV4112CDGN      | ACTIVE        | MSOP-PowerPAD | DGN             | 8    | 80          | Green (RoHS & no Sb/Br) | CU NIPDAU  <br>CU NIPDAUAG | Level-1-260C-UNLIM   | 0 to 70      | AHP                     | <a href="#">Samples</a> |
| TLV4112CP        | ACTIVE        | PDIP          | P               | 8    | 50          | Green (RoHS & no Sb/Br) | CU NIPDAU                  | N / A for Pkg Type   | 0 to 70      | TLV4112C                | <a href="#">Samples</a> |
| TLV4112ID        | ACTIVE        | SOIC          | D               | 8    | 75          | Green (RoHS & no Sb/Br) | CU NIPDAU                  | Level-1-260C-UNLIM   | -40 to 125   | 4112I                   | <a href="#">Samples</a> |

| Orderable Device | Status<br>(1) | Package Type  | Package Drawing | Pins | Package Qty | Eco Plan<br>(2)         | Lead/Ball Finish<br>(6) | MSL Peak Temp<br>(3) | Op Temp (°C) | Device Marking<br>(4/5) | Samples                 |
|------------------|---------------|---------------|-----------------|------|-------------|-------------------------|-------------------------|----------------------|--------------|-------------------------|-------------------------|
| TLV4112IDGN      | ACTIVE        | MSOP-PowerPAD | DGN             | 8    | 80          | Green (RoHS & no Sb/Br) | CU NIPDAU   CU NIPDAUAG | Level-1-260C-UNLIM   | -40 to 125   | AHQ                     | <a href="#">Samples</a> |
| TLV4112IDGNR     | ACTIVE        | MSOP-PowerPAD | DGN             | 8    | 2500        | Green (RoHS & no Sb/Br) | CU NIPDAU   CU NIPDAUAG | Level-1-260C-UNLIM   | -40 to 125   | AHQ                     | <a href="#">Samples</a> |
| TLV4112IDGNRG4   | ACTIVE        | MSOP-PowerPAD | DGN             | 8    | 2500        | Green (RoHS & no Sb/Br) | CU NIPDAUAG             | Level-1-260C-UNLIM   | -40 to 125   | AHQ                     | <a href="#">Samples</a> |
| TLV4112IDR       | ACTIVE        | SOIC          | D               | 8    | 2500        | Green (RoHS & no Sb/Br) | CU NIPDAU               | Level-1-260C-UNLIM   | -40 to 125   | 4112I                   | <a href="#">Samples</a> |
| TLV4112IP        | ACTIVE        | PDIP          | P               | 8    | 50          | Green (RoHS & no Sb/Br) | CU NIPDAU               | N / A for Pkg Type   | -40 to 125   | TLV4112I                | <a href="#">Samples</a> |
| TLV4113ID        | ACTIVE        | SOIC          | D               | 14   | 50          | Green (RoHS & no Sb/Br) | CU NIPDAU               | Level-1-260C-UNLIM   | -40 to 125   | 4113I                   | <a href="#">Samples</a> |
| TLV4113IDGQ      | ACTIVE        | MSOP-PowerPAD | DGQ             | 10   | 80          | Green (RoHS & no Sb/Br) | CU NIPDAU   Call TI     | Level-1-260C-UNLIM   | -40 to 125   | AHS                     | <a href="#">Samples</a> |
| TLV4113IDGQR     | ACTIVE        | MSOP-PowerPAD | DGQ             | 10   | 2500        | Green (RoHS & no Sb/Br) | CU NIPDAU               | Level-1-260C-UNLIM   | -40 to 125   | AHS                     | <a href="#">Samples</a> |
| TLV4113IN        | ACTIVE        | PDIP          | N               | 14   | 25          | Green (RoHS & no Sb/Br) | CU NIPDAU               | N / A for Pkg Type   | -40 to 125   | TLV4113I                | <a href="#">Samples</a> |

(1) The marketing status values are defined as follows:

**ACTIVE:** Product device recommended for new designs.

**LIFEBUY:** TI has announced that the device will be discontinued, and a lifetime-buy period is in effect.

**NRND:** Not recommended for new designs. Device is in production to support existing customers, but TI does not recommend using this part in a new design.

**PREVIEW:** Device has been announced but is not in production. Samples may or may not be available.

**OBSELETE:** TI has discontinued the production of the device.

(2) **RoHS:** TI defines "RoHS" to mean semiconductor products that are compliant with the current EU RoHS requirements for all 10 RoHS substances, including the requirement that RoHS substance do not exceed 0.1% by weight in homogeneous materials. Where designed to be soldered at high temperatures, "RoHS" products are suitable for use in specified lead-free processes. TI may reference these types of products as "Pb-Free".

**RoHS Exempt:** TI defines "RoHS Exempt" to mean products that contain lead but are compliant with EU RoHS pursuant to a specific EU RoHS exemption.

**Green:** TI defines "Green" to mean the content of Chlorine (Cl) and Bromine (Br) based flame retardants meet JS709B low halogen requirements of <=1000ppm threshold. Antimony trioxide based flame retardants must also meet the <=1000ppm threshold requirement.

(3) MSL, Peak Temp. - The Moisture Sensitivity Level rating according to the JEDEC industry standard classifications, and peak solder temperature.

(4) There may be additional marking, which relates to the logo, the lot trace code information, or the environmental category on the device.

(5) Multiple Device Markings will be inside parentheses. Only one Device Marking contained in parentheses and separated by a "-" will appear on a device. If a line is indented then it is a continuation of the previous line and the two combined represent the entire Device Marking for that device.

(6) Lead/Ball Finish - Orderable Devices may have multiple material finish options. Finish options are separated by a vertical ruled line. Lead/Ball Finish values may wrap to two lines if the finish value exceeds the maximum column width.

**Important Information and Disclaimer:**The information provided on this page represents TI's knowledge and belief as of the date that it is provided. TI bases its knowledge and belief on information provided by third parties, and makes no representation or warranty as to the accuracy of such information. Efforts are underway to better integrate information from third parties. TI has taken and continues to take reasonable steps to provide representative and accurate information but may not have conducted destructive testing or chemical analysis on incoming materials and chemicals. TI and TI suppliers consider certain information to be proprietary, and thus CAS numbers and other limited information may not be available for release.

In no event shall TI's liability arising out of such information exceed the total purchase price of the TI part(s) at issue in this document sold by TI to Customer on an annual basis.

**OTHER QUALIFIED VERSIONS OF TLV4113 :**

- Enhanced Product: [TLV4113-EP](#)

NOTE: Qualified Version Definitions:

- Enhanced Product - Supports Defense, Aerospace and Medical Applications

## TAPE AND REEL INFORMATION



### QUADRANT ASSIGNMENTS FOR PIN 1 ORIENTATION IN TAPE



\*All dimensions are nominal

| Device       | Package Type   | Package Drawing | Pins | SPQ  | Reel Diameter (mm) | Reel Width W1 (mm) | A0 (mm) | B0 (mm) | K0 (mm) | P1 (mm) | W (mm) | Pin1 Quadrant |
|--------------|----------------|-----------------|------|------|--------------------|--------------------|---------|---------|---------|---------|--------|---------------|
| TLV4110IDGNR | MSOP-Power PAD | DGN             | 8    | 2500 | 330.0              | 12.4               | 5.3     | 3.4     | 1.4     | 8.0     | 12.0   | Q1            |
| TLV4110IDR   | SOIC           | D               | 8    | 2500 | 330.0              | 12.4               | 6.4     | 5.2     | 2.1     | 8.0     | 12.0   | Q1            |
| TLV4111IDGNR | MSOP-Power PAD | DGN             | 8    | 2500 | 330.0              | 12.4               | 5.3     | 3.4     | 1.4     | 8.0     | 12.0   | Q1            |
| TLV4111IDR   | SOIC           | D               | 8    | 2500 | 330.0              | 12.4               | 6.4     | 5.2     | 2.1     | 8.0     | 12.0   | Q1            |
| TLV4112IDGNR | MSOP-Power PAD | DGN             | 8    | 2500 | 330.0              | 12.4               | 5.3     | 3.4     | 1.4     | 8.0     | 12.0   | Q1            |
| TLV4112IDGNR | MSOP-Power PAD | DGN             | 8    | 2500 | 330.0              | 12.4               | 5.3     | 3.4     | 1.4     | 8.0     | 12.0   | Q1            |
| TLV4112IDR   | SOIC           | D               | 8    | 2500 | 330.0              | 12.4               | 6.4     | 5.2     | 2.1     | 8.0     | 12.0   | Q1            |
| TLV4113IDGQR | MSOP-Power PAD | DGQ             | 10   | 2500 | 330.0              | 12.4               | 5.3     | 3.4     | 1.4     | 8.0     | 12.0   | Q1            |

**TAPE AND REEL BOX DIMENSIONS**

\*All dimensions are nominal

| Device       | Package Type  | Package Drawing | Pins | SPQ  | Length (mm) | Width (mm) | Height (mm) |
|--------------|---------------|-----------------|------|------|-------------|------------|-------------|
| TLV4110IDGNR | MSOP-PowerPAD | DGN             | 8    | 2500 | 358.0       | 335.0      | 35.0        |
| TLV4110IDR   | SOIC          | D               | 8    | 2500 | 340.5       | 338.1      | 20.6        |
| TLV4111IDGNR | MSOP-PowerPAD | DGN             | 8    | 2500 | 358.0       | 335.0      | 35.0        |
| TLV4111IDR   | SOIC          | D               | 8    | 2500 | 340.5       | 338.1      | 20.6        |
| TLV4112IDGNR | MSOP-PowerPAD | DGN             | 8    | 2500 | 358.0       | 335.0      | 35.0        |
| TLV4112IDGNR | MSOP-PowerPAD | DGN             | 8    | 2500 | 364.0       | 364.0      | 27.0        |
| TLV4112IDR   | SOIC          | D               | 8    | 2500 | 340.5       | 338.1      | 20.6        |
| TLV4113IDGQR | MSOP-PowerPAD | DGQ             | 10   | 2500 | 358.0       | 335.0      | 35.0        |



D (R-PDSO-G14)

PLASTIC SMALL OUTLINE



4211283-3/E 08/12

- NOTES:
- All linear dimensions are in millimeters.
  - This drawing is subject to change without notice.
  - Publication IPC-7351 is recommended for alternate designs.
  - Laser cutting apertures with trapezoidal walls and also rounding corners will offer better paste release. Customers should contact their board assembly site for stencil design recommendations. Refer to IPC-7525 for other stencil recommendations.
  - Customers should contact their board fabrication site for solder mask tolerances between and around signal pads.



D0008A

# PACKAGE OUTLINE

SOIC - 1.75 mm max height

SMALL OUTLINE INTEGRATED CIRCUIT



### NOTES:

1. Linear dimensions are in inches [millimeters]. Dimensions in parenthesis are for reference only. Controlling dimensions are in inches. Dimensioning and tolerancing per ASME Y14.5M.
2. This drawing is subject to change without notice.
3. This dimension does not include mold flash, protrusions, or gate burrs. Mold flash, protrusions, or gate burrs shall not exceed  $.006$  [0.15] per side.
4. This dimension does not include interlead flash.
5. Reference JEDEC registration MS-012, variation AA.

# EXAMPLE BOARD LAYOUT

D0008A

SOIC - 1.75 mm max height

SMALL OUTLINE INTEGRATED CIRCUIT



LAND PATTERN EXAMPLE  
EXPOSED METAL SHOWN  
SCALE:8X



SOLDER MASK DETAILS

4214825/C 02/2019

NOTES: (continued)

- 6. Publication IPC-7351 may have alternate designs.
- 7. Solder mask tolerances between and around signal pads can vary based on board fabrication site.

# EXAMPLE STENCIL DESIGN

D0008A

SOIC - 1.75 mm max height

SMALL OUTLINE INTEGRATED CIRCUIT



SOLDER PASTE EXAMPLE  
BASED ON .005 INCH [0.125 MM] THICK STENCIL  
SCALE:8X

4214825/C 02/2019

NOTES: (continued)

8. Laser cutting apertures with trapezoidal walls and rounded corners may offer better paste release. IPC-7525 may have alternate design recommendations.
9. Board assembly site may have different recommendations for stencil design.

P (R-PDIP-T8)

PLASTIC DUAL-IN-LINE PACKAGE

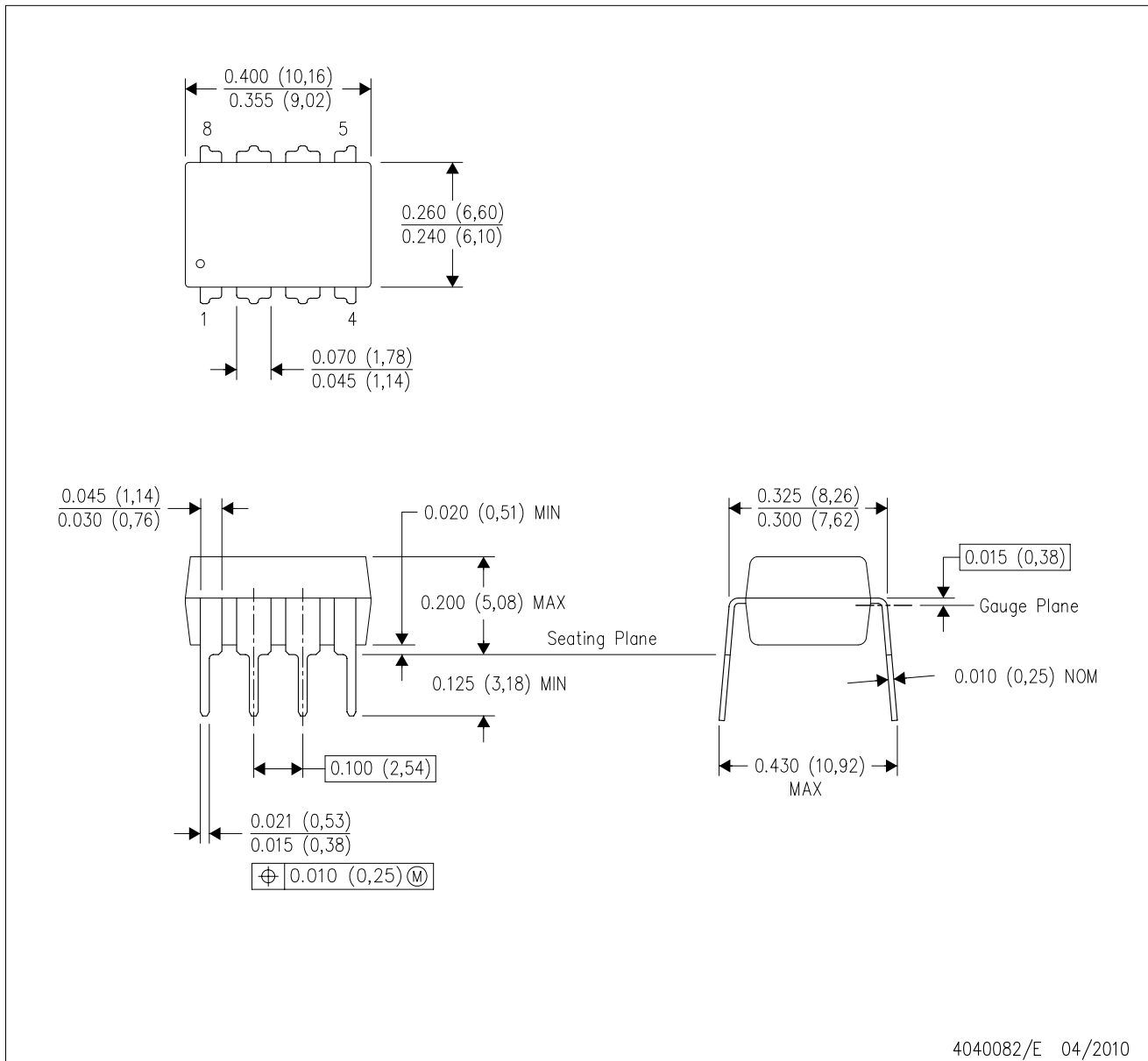

4040082/E 04/2010

- NOTES:
- A. All linear dimensions are in inches (millimeters).
  - B. This drawing is subject to change without notice.
  - C. Falls within JEDEC MS-001 variation BA.

N (R-PDIP-T\*\*)

PLASTIC DUAL-IN-LINE PACKAGE

16 PINS SHOWN



- NOTES:
- A. All linear dimensions are in inches (millimeters).
  - B. This drawing is subject to change without notice.
  - Falls within JEDEC MS-001, except 18 and 20 pin minimum body length (Dim A).
  - The 20 pin end lead shoulder width is a vendor option, either half or full width.

DGQ (S-PDSO-G10)

PowerPAD™ PLASTIC SMALL OUTLINE

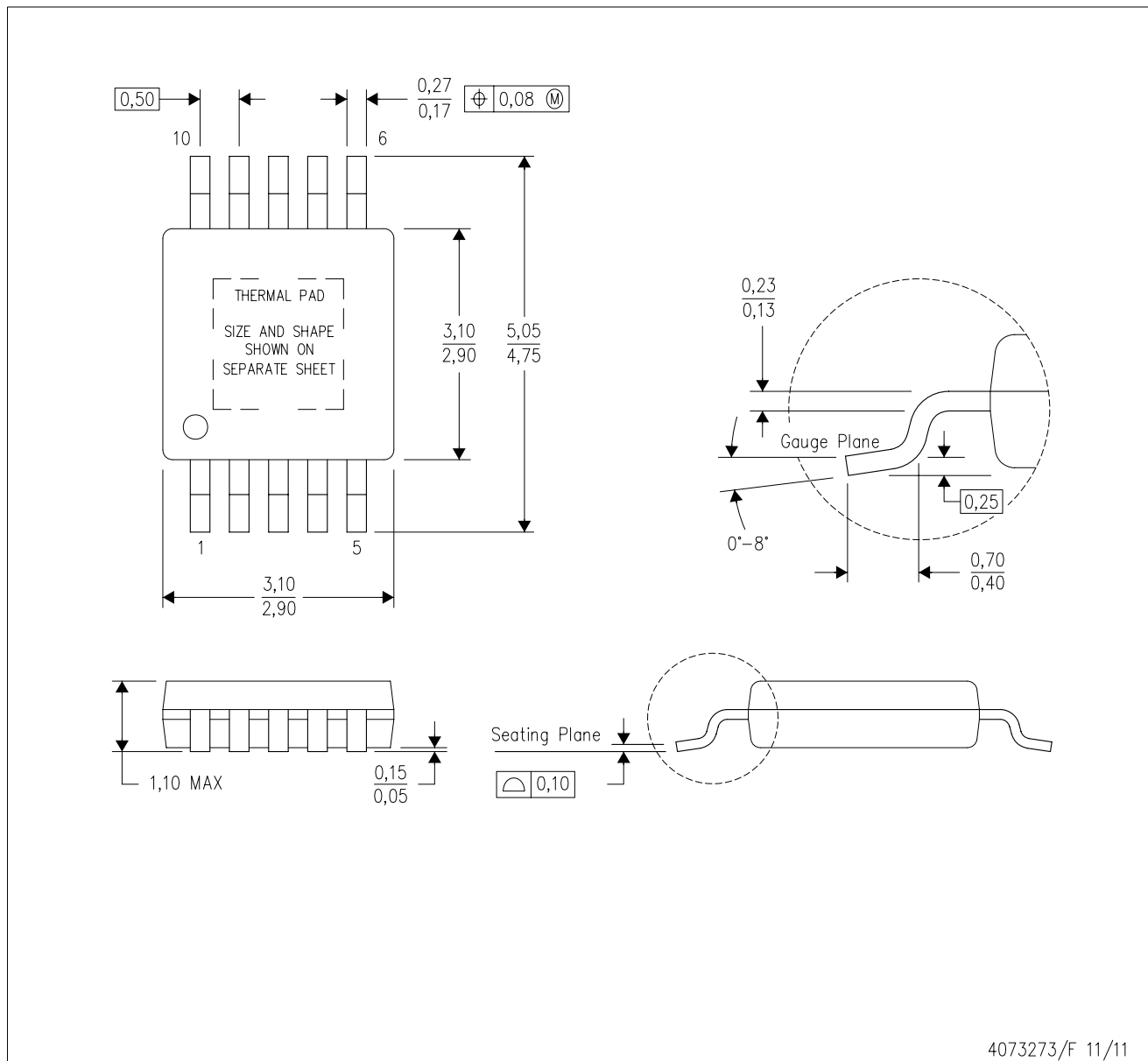

- NOTES:
- A. All linear dimensions are in millimeters.
  - B. This drawing is subject to change without notice.
  - C. Body dimensions do not include mold flash or protrusion not to exceed 0,15.
  - D. This package is designed to be soldered to a thermal pad on the board. Refer to Technical Brief, PowerPad Thermally Enhanced Package, Texas Instruments Literature No. SLMA002 for information regarding recommended board layout. This document is available at [www.ti.com](http://www.ti.com) <<http://www.ti.com>>.
  - E. See the additional figure in the Product Data Sheet for details regarding the exposed thermal pad features and dimensions.
  - F. Falls within JEDEC MO-187 variation BA-T.

PowerPAD is a trademark of Texas Instruments.

DGQ (S-PDSO-G10)

PowerPAD™ PLASTIC SMALL OUTLINE

## THERMAL INFORMATION

This PowerPAD™ package incorporates an exposed thermal pad that is designed to be attached to a printed circuit board (PCB). The thermal pad must be soldered directly to the PCB. After soldering, the PCB can be used as a heatsink. In addition, through the use of thermal vias, the thermal pad can be attached directly to the appropriate copper plane shown in the electrical schematic for the device, or alternatively, can be attached to a special heatsink structure designed into the PCB. This design optimizes the heat transfer from the integrated circuit (IC).

For additional information on the PowerPAD package and how to take advantage of its heat dissipating abilities, refer to Technical Brief, PowerPAD Thermally Enhanced Package, Texas Instruments Literature No. SLMA002 and Application Brief, PowerPAD Made Easy, Texas Instruments Literature No. SLMA004. Both documents are available at [www.ti.com](http://www.ti.com).

The exposed thermal pad dimensions for this package are shown in the following illustration.

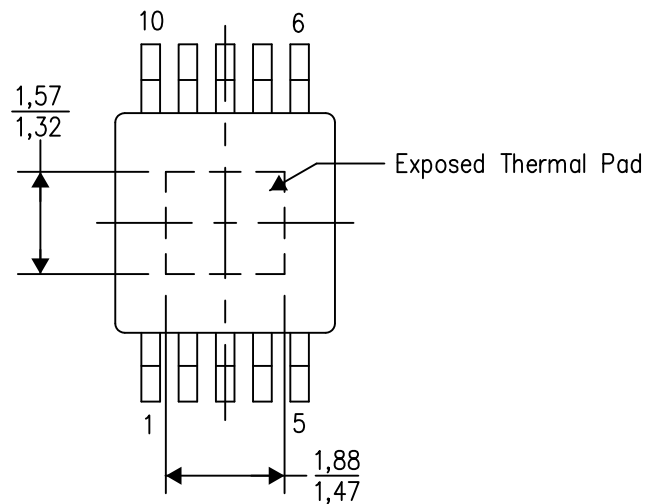

Top View

Exposed Thermal Pad Dimensions

4206324-2/H 12/14

NOTE: A. All linear dimensions are in millimeters

PowerPAD is a trademark of Texas Instruments

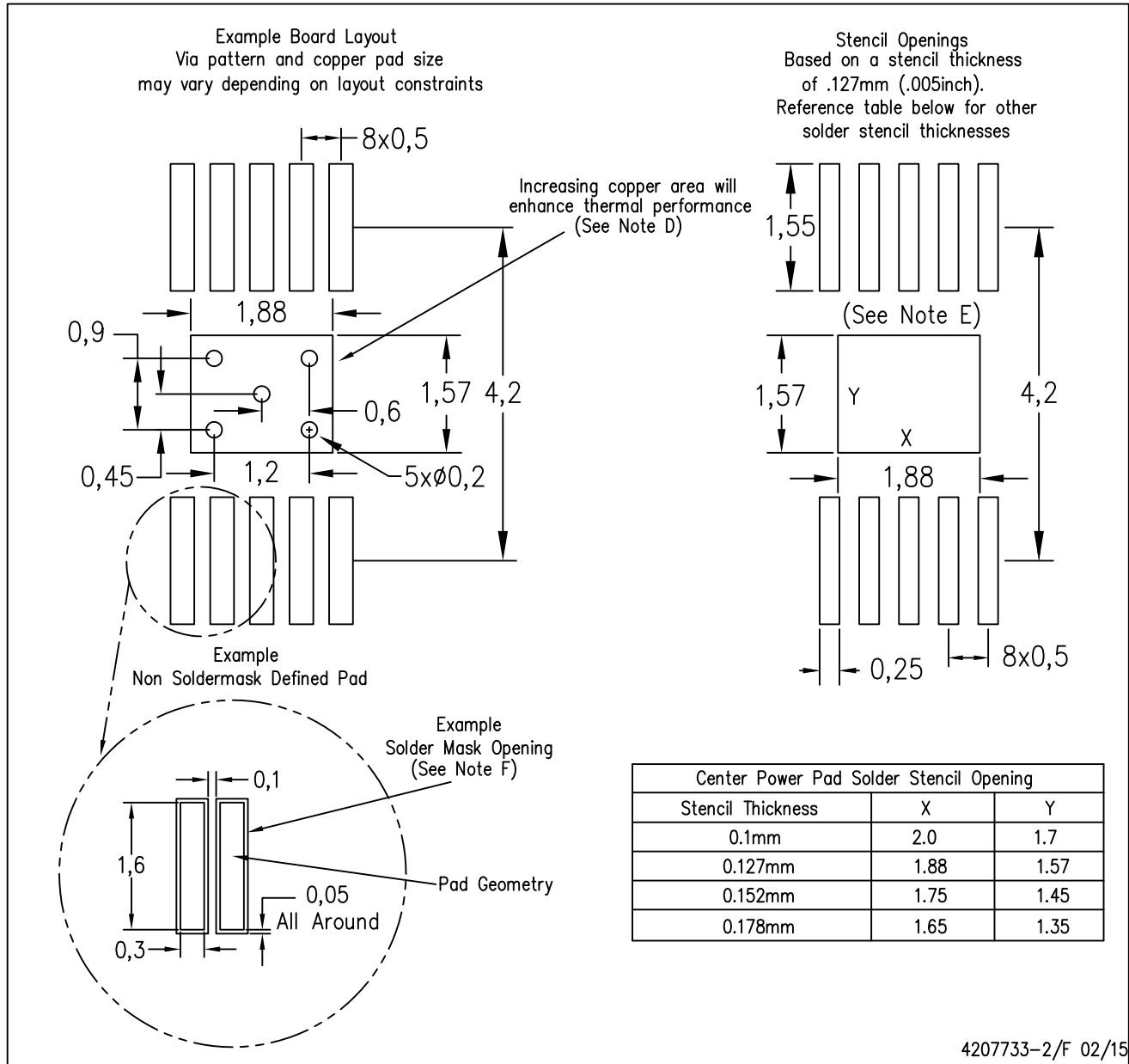

- NOTES:
- All linear dimensions are in millimeters.
  - This drawing is subject to change without notice.
  - Customers should place a note on the circuit board fabrication drawing not to alter the center solder mask defined pad.
  - This package is designed to be soldered to a thermal pad on the board. Refer to Technical Brief, PowerPad Thermally Enhanced Package, Texas Instruments Literature No. SLMA002, SLMA004, and also the Product Data Sheets for specific thermal information, via requirements, and recommended board layout. These documents are available at [www.ti.com](http://www.ti.com) <<http://www.ti.com>>. Publication IPC-7351 is recommended for alternate designs.
  - Laser cutting apertures with trapezoidal walls and also rounding corners will offer better paste release. Customers should contact their board assembly site for stencil design recommendations. Example stencil design based on a 50% volumetric metal load solder paste. Refer to IPC-7525 for other stencil recommendations.
  - Customers should contact their board fabrication site for solder mask tolerances between and around signal pads.

PowerPAD is a trademark of Texas Instruments

DGN (S-PDSO-G8)

PowerPAD™ PLASTIC SMALL OUTLINE

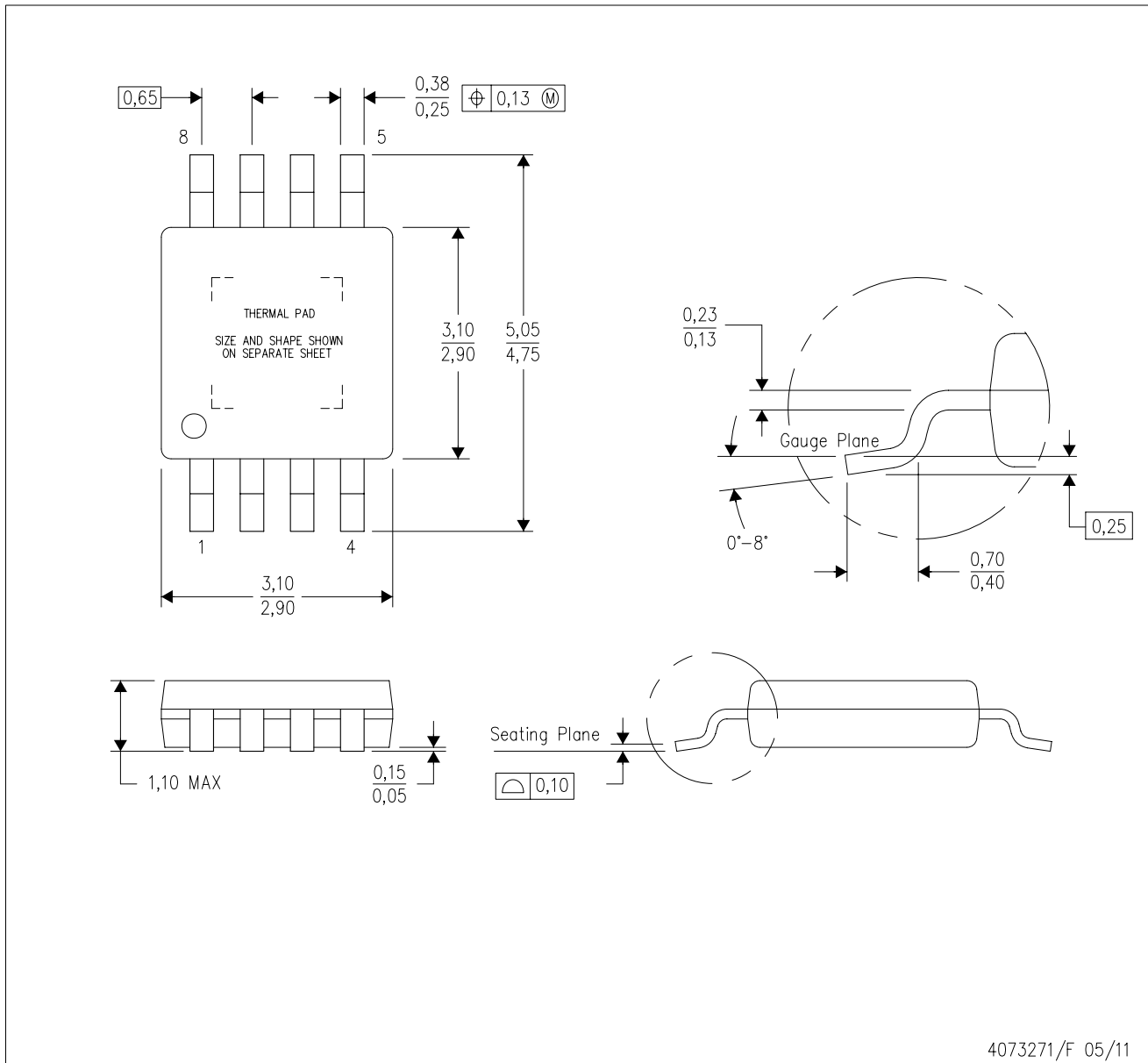

- NOTES:
- All linear dimensions are in millimeters.
  - This drawing is subject to change without notice.
  - Body dimensions do not include mold flash or protrusion.
  - This package is designed to be soldered to a thermal pad on the board. Refer to Technical Brief, PowerPad Thermally Enhanced Package, Texas Instruments Literature No. SLMA002 for information regarding recommended board layout. This document is available at [www.ti.com](http://www.ti.com) <<http://www.ti.com>>.
  - See the additional figure in the Product Data Sheet for details regarding the exposed thermal pad features and dimensions.
  - Falls within JEDEC MO-187 variation AA-T

PowerPAD is a trademark of Texas Instruments.

DGN (S-PDSO-G8)

PowerPAD™ PLASTIC SMALL OUTLINE

## THERMAL INFORMATION

This PowerPAD™ package incorporates an exposed thermal pad that is designed to be attached to a printed circuit board (PCB). The thermal pad must be soldered directly to the PCB. After soldering, the PCB can be used as a heatsink. In addition, through the use of thermal vias, the thermal pad can be attached directly to the appropriate copper plane shown in the electrical schematic for the device, or alternatively, can be attached to a special heatsink structure designed into the PCB. This design optimizes the heat transfer from the integrated circuit (IC).

For additional information on the PowerPAD package and how to take advantage of its heat dissipating abilities, refer to Technical Brief, PowerPAD Thermally Enhanced Package, Texas Instruments Literature No. SLMA002 and Application Brief, PowerPAD Made Easy, Texas Instruments Literature No. SLMA004. Both documents are available at [www.ti.com](http://www.ti.com).

The exposed thermal pad dimensions for this package are shown in the following illustration.

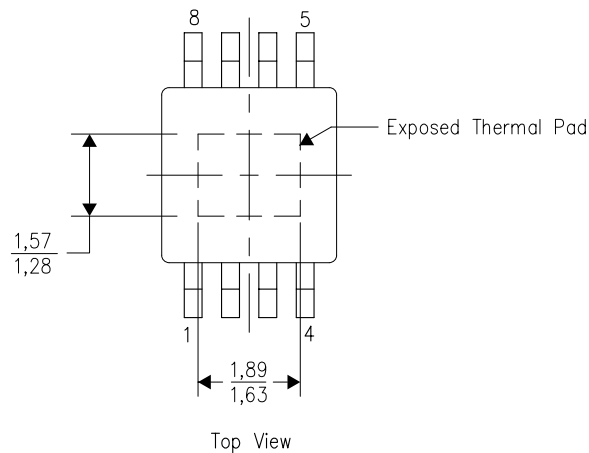

Exposed Thermal Pad Dimensions

4206323-2/1 12/11

NOTE: All linear dimensions are in millimeters

PowerPAD is a trademark of Texas Instruments



- NOTES:
- A. All linear dimensions are in millimeters.
  - B. This drawing is subject to change without notice.
  - C. Customers should place a note on the circuit board fabrication drawing not to alter the center solder mask defined pad.
  - D. This package is designed to be soldered to a thermal pad on the board. Refer to Technical Brief, PowerPad Thermally Enhanced Package, Texas Instruments Literature No. SLMA002, SLMA004, and also the Product Data Sheets for specific thermal information, via requirements, and recommended board layout. These documents are available at [www.ti.com](http://www.ti.com) <<http://www.ti.com>>.
  - E. Laser cutting apertures with trapezoidal walls and also rounding corners will offer better paste release. Customers should contact their board assembly site for stencil design recommendations. Example stencil design based on a 50% volumetric metal load solder paste. Refer to IPC-7525 for other stencil recommendations.
  - F. Customers should contact their board fabrication site for solder mask tolerances between and around signal pads.

PowerPAD is a trademark of Texas Instruments

## IMPORTANT NOTICE AND DISCLAIMER

TI PROVIDES TECHNICAL AND RELIABILITY DATA (INCLUDING DATASHEETS), DESIGN RESOURCES (INCLUDING REFERENCE DESIGNS), APPLICATION OR OTHER DESIGN ADVICE, WEB TOOLS, SAFETY INFORMATION, AND OTHER RESOURCES "AS IS" AND WITH ALL FAULTS, AND DISCLAIMS ALL WARRANTIES, EXPRESS AND IMPLIED, INCLUDING WITHOUT LIMITATION ANY IMPLIED WARRANTIES OF MERCHANTABILITY, FITNESS FOR A PARTICULAR PURPOSE OR NON-INFRINGEMENT OF THIRD PARTY INTELLECTUAL PROPERTY RIGHTS.

These resources are intended for skilled developers designing with TI products. You are solely responsible for (1) selecting the appropriate TI products for your application, (2) designing, validating and testing your application, and (3) ensuring your application meets applicable standards, and any other safety, security, or other requirements. These resources are subject to change without notice. TI grants you permission to use these resources only for development of an application that uses the TI products described in the resource. Other reproduction and display of these resources is prohibited. No license is granted to any other TI intellectual property right or to any third party intellectual property right. TI disclaims responsibility for, and you will fully indemnify TI and its representatives against, any claims, damages, costs, losses, and liabilities arising out of your use of these resources.

TI's products are provided subject to TI's Terms of Sale ([www.ti.com/legal/termsofsale.html](http://www.ti.com/legal/termsofsale.html)) or other applicable terms available either on [ti.com](http://ti.com) or provided in conjunction with such TI products. TI's provision of these resources does not expand or otherwise alter TI's applicable warranties or warranty disclaimers for TI products.

Mailing Address: Texas Instruments, Post Office Box 655303, Dallas, Texas 75265  
Copyright © 2019, Texas Instruments Incorporated

## Looking for pricing, stock, or lifecycle information?

Click below to explore more details on WIN SOURCE:

 [View TLV4113ID](#) on WIN SOURCE

 [Texas Instruments](#) Information

## Optimize Your Supply Chain with WIN SOURCE Solutions

-  Global Sourcing Solution
-  Obsolete Management
-  Cost Control Management
-  Shortage Management
-  Alternative Solution
-  Excess Inventory Management