



THE DATASHEET OF TPS2031D



POWER-DISTRIBUTION SWITCHES

FEATURES

- 33-mΩ (5-V Input) High-Side MOSFET Switch
- Short-Circuit and Thermal Protection
- Overcurrent Logic Output
- Operating Range: 2.7 V to 5.5 V
- Logic-Level Enable Input
- Typical Rise Time: 6.1 ms
- Undervoltage Lockout
- Maximum Standby Supply Current: 10 μA
- No Drain-Source Back-Gate Diode
- Available in 8-pin SOIC and PDIP Packages
- Ambient Temperature Range, –40°C to 85°C
- 2-kV Human-Body-Model, 200-V Machine-Model ESD Protection
- UL Listed– File No. E169910

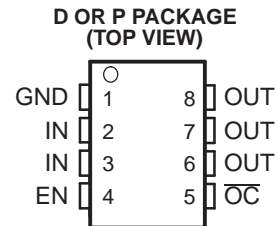

DESCRIPTION

The TPS203x family of power distribution switches is intended for applications where heavy capacitive loads and short circuits are likely to be encountered. These devices are 50-mΩ N-channel MOSFET high-side power switches. The switch is controlled by a logic enable compatible with 5-V logic and 3-V logic. Gate drive is provided by an internal charge pump designed to control the power-switch rise times and fall times to minimize current surges during switching. The charge pump requires no external components and allows operation from supplies as low as 2.7 V.

When the output load exceeds the current-limit threshold or a short is present, the TPS203x limits the output current to a safe level by switching into a constant-current mode, pulling the overcurrent (OC) logic output low. When continuous heavy overloads and short circuits increase the power dissipation in the switch, causing the junction temperature to rise, a thermal protection circuit shuts off the switch to prevent damage. Recovery from a thermal shutdown is automatic once the device has cooled sufficiently. Internal circuitry ensures the switch remains off until valid input voltage is present.

The TPS203x devices differ only in short-circuit current threshold. The TPS2030 limits at 0.3-A load, the TPS2031 at 0.9-A load, the TPS2032 at 1.5-A load, the TPS2033 at 2.2-A load, and the TPS2034 at 3-A load (see Available Options). The TPS203x is available in an 8-pin small-outline integrated-circuit (SOIC) package and in an 8-pin dual-in-line (DIP) package and operates over a junction temperature range of –40°C to 125°C.

GENERAL SWITCH CATALOG						
33 mΩ, Single	80 mΩ, Single	80 mΩ, Dual	80 mΩ, Dual	80 mΩ, Triple	80 mΩ, Quad	80 mΩ, Quad
TPS201xA 0.2 A to 2 A TPS202x 0.2 A to 2 A TPS203x 0.2 A to 2 A	TPS2014 600 mA TPS2015 1 A TPS2041B 500 mA TPS2045A 250 mA TPS2049 100 mA TPS2055A 250 mA TPS2061 1 A TPS2065 1 A TPS2068 1.5 A TPS2069 1.5 A	TPS2042B 500 mA TPS2052B 500 mA TPS2046B 250 mA TPS2056 250 mA TPS2062 1 A TPS2066 1 A TPS2060 1.5 A TPS2064 1.5 A	TPS2080 500 mA TPS2081 500 mA TPS2082 500 mA TPS2090 250 mA TPS2091 250 mA TPS2092 250 mA	TPS2043B 500 mA TPS2053B 500 mA TPS2047B 250 mA TPS2057A 250 mA TPS2063 1 A TPS2067 1 A	TPS2044B 500 mA TPS2054B 500 mA TPS2048A 250 mA TPS2058 250 mA	TPS2085 500 mA TPS2086 500 mA TPS2087 500 mA TPS2095 250 mA TPS2096 250 mA TPS2097 250 mA



Please be aware that an important notice concerning availability, standard warranty, and use in critical applications of Texas Instruments semiconductor products and disclaimers thereto appears at the end of this data sheet.



These devices have limited built-in ESD protection. The leads should be shorted together or the device placed in conductive foam during storage or handling to prevent electrostatic damage to the MOS gates.

AVAILABLE OPTIONS

T _A	ENABLE	RECOMMENDED MAXIMUM CONTINUOUS LOAD CURRENT (A)	TYPICAL SHORT-CIRCUIT CURRENT LIMIT AT 25°C (A)	PACKAGED DEVICES ⁽¹⁾	
				SMALL OUTLINE (D) ⁽²⁾	PLASTIC DIP (P)
–40°C to 85°C	Active high	0.2	0.3	TPS2030D	TPS2030P
		0.6	0.9	TPS2031D	TPS2031P
		1	1.5	TPS2032D	TPS2032P
		1.5	2.2	TPS2033D	TPS2033P
		2	3	TPS2034D	TPS2034P

- (1) For the most current package and ordering information, see the Package Option Addendum at the end of this document, or see the TI website at www.ti.com.
 (2) The D package is available taped and reeled. Add an R suffix to device type (e.g., TPS2030DR)

TPS2030 FUNCTIONAL BLOCK DIAGRAM

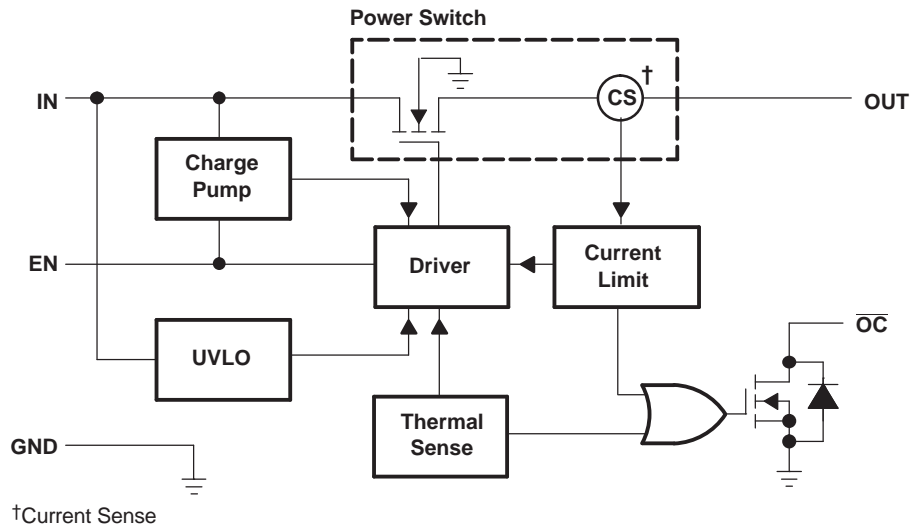

TERMINAL FUNCTIONS

TERMINAL		I/O	DESCRIPTION
NAME	NO. D OR P		
EN	4	I	Enable input. Logic high turns on power switch.
GND	1	I	Ground
IN	2, 3	I	Input voltage
\overline{OC}	5	O	Overcurrent. Logic output active low
OUT	6, 7, 8	O	Power-switch output

DETAILED DESCRIPTION

POWER SWITCH

The power switch is an N-channel MOSFET with a maximum on-state resistance of 50 m Ω ($V_{I(IN)} = 5$ V). Configured as a high-side switch, the power switch prevents current flow from OUT to IN and IN to OUT when disabled.

CHARGE PUMP

An internal charge pump supplies power to the driver circuit and provides the necessary voltage to pull the gate of the MOSFET above the source. The charge pump operates from input voltages as low as 2.7 V and requires very little supply current.

DRIVER

The driver controls the gate voltage of the power switch. To limit large current surges and reduce the associated electromagnetic interference (EMI) produced, the driver incorporates circuitry that controls the rise times and fall times of the output voltage. The rise and fall times are typically in the 2-ms to 9-ms range.

ENABLE (EN)

The logic enable disables the power switch, the bias for the charge pump, driver, and other circuitry to reduce the supply current to less than 10 μ A when a logic low is present on EN. A logic high input on EN restores bias to the drive and control circuits and turns the power on. The enable input is compatible with both TTL and CMOS logic levels.

OVERCURRENT (\overline{OC})

The \overline{OC} open drain output is asserted (active low) when an overcurrent or overtemperature condition is encountered. The output will remain asserted until the overcurrent or overtemperature condition is removed.

CURRENT SENSE

A sense FET monitors the current supplied to the load. The sense FET measures current more efficiently than conventional resistance methods. When an overload or short circuit is encountered, the current-sense circuitry sends a control signal to the driver. The driver, in turn, reduces the gate voltage and drives the power FET into its saturation region, which switches the output into a constant current mode and holds the current constant while varying the voltage on the load.

THERMAL SENSE

An internal thermal-sense circuit shuts off the power switch when the junction temperature rises to approximately 140°C. Hysteresis is built into the thermal sense circuit. After the device has cooled approximately 20°C, the switch turns back on. The switch continues to cycle off and on until the fault is removed.

UNDERVOLTAGE LOCKOUT

A voltage sense circuit monitors the input voltage. When the input voltage is below approximately 2 V, a control signal turns off the power switch.

ABSOLUTE MAXIMUM RATINGS

over operating free-air temperature range (unless otherwise noted)⁽¹⁾

		VALUE	UNIT	
$V_{I(IN)}$ ⁽²⁾	Input voltage range	–0.3 to 6	V	
$V_{O(OUT)}$ ⁽²⁾	Output voltage range	–0.3 to $V_{I(IN)} + 0.3$	V	
$V_{I(EN)}$	Input voltage range	–0.3 to 6	V	
$I_{O(OUT)}$	Continuous output current	Internally limited		
Continuous total power dissipation		See Dissipation Rating Table		
T_J	Operating virtual junction temperature range	–40 to 125	°C	
T_{stg}	Storage temperature range	–65 to 150	°C	
ESD	Electrostatic discharge protection:	Human body model	2	kV
		Machine model	200	V
		Charged device model (CDM)	750	V

- (1) Stresses beyond those listed under *absolute maximum ratings* may cause permanent damage to the device. These are stress ratings only, and functional operation of the device at these or any other conditions beyond those indicated under *recommended operating conditions* is not implied. Exposure to absolute-maximum-rated conditions for extended periods may affect device reliability.
- (2) All voltages are with respect to GND.

DISSIPATION RATING TABLE

PACKAGE	$T_A \leq 25^\circ\text{C}$ POWER RATING	DERATING FACTOR ABOVE $T_A = 25^\circ\text{C}$	$T_A = 70^\circ\text{C}$ POWER RATING	$T_A = 85^\circ\text{C}$ POWER RATING
D	725 mW	5.8 mW/°C	464 mW	377 mW
P	1175 mW	9.4 mW/°C	752 mW	611 mW

RECOMMENDED OPERATING CONDITIONS

		MIN	MAX	UNIT	
Input voltage	$V_{I(IN)}$	2.7	5.5	V	
	$V_{I(EN)}$	0	5.5	V	
I_O	Continuous output current	TPS2030	0	0.2	A
		TPS2031	0	0.6	
		TPS2032	0	1	
		TPS2033	0	1.5	
		TPS2034	0	2	
T_J	Operating virtual junction temperature	–40	125	°C	

ELECTRICAL CHARACTERISTICS

over recommended operating junction temperature range, $V_{I(IN)} = 5.5\text{ V}$, $I_O = \text{rated current}$, $EN = 5\text{ V}$ (unless otherwise noted)

POWER SWITCH								
PARAMETER		TEST CONDITIONS ⁽¹⁾			MIN	TYP	MAX	UNIT
$r_{DS(on)}$	Static drain-source on-state resistance	$V_{I(IN)} = 5\text{ V}$, $T_J = 25^\circ\text{C}$, $I_O = 1.8\text{ A}$				33	36	m Ω
		$V_{I(IN)} = 5\text{ V}$, $T_J = 85^\circ\text{C}$, $I_O = 1.8\text{ A}$				38	46	
		$V_{I(IN)} = 5\text{ V}$, $T_J = 125^\circ\text{C}$, $I_O = 1.8\text{ A}$				44	50	
		$V_{I(IN)} = 3.3\text{ V}$, $T_J = 25^\circ\text{C}$, $I_O = 1.8\text{ A}$				37	41	
		$V_{I(IN)} = 3.3\text{ V}$, $T_J = 85^\circ\text{C}$, $I_O = 1.8\text{ A}$				43	52	
		$V_{I(IN)} = 3.3\text{ V}$, $T_J = 125^\circ\text{C}$, $I_O = 1.8\text{ A}$				51	61	
		$V_{I(IN)} = 5\text{ V}$, $T_J = 25^\circ\text{C}$, $I_O = 0.18\text{ A}$				30	34	
		$V_{I(IN)} = 5\text{ V}$, $T_J = 85^\circ\text{C}$, $I_O = 0.18\text{ A}$				35	41	
		$V_{I(IN)} = 5\text{ V}$, $T_J = 125^\circ\text{C}$, $I_O = 0.18\text{ A}$				39	47	
		$V_{I(IN)} = 3.3\text{ V}$, $T_J = 25^\circ\text{C}$, $I_O = 0.18\text{ A}$				33	37	
		$V_{I(IN)} = 3.3\text{ V}$, $T_J = 85^\circ\text{C}$, $I_O = 0.18\text{ A}$				39	46	
		$V_{I(IN)} = 3.3\text{ V}$, $T_J = 125^\circ\text{C}$, $I_O = 0.18\text{ A}$				44	56	
t_r	Rise time, output	$V_{I(IN)} = 5.5\text{ V}$, $T_J = 25^\circ\text{C}$, $C_L = 1\text{ }\mu\text{F}$, $R_L = 10\text{ }\Omega$				6.1	ms	
		$V_{I(IN)} = 2.7\text{ V}$, $T_J = 25^\circ\text{C}$, $C_L = 1\text{ }\mu\text{F}$, $R_L = 10\text{ }\Omega$				8.6		
t_f	Fall time, output	$V_{I(IN)} = 5.5\text{ V}$, $T_J = 25^\circ\text{C}$, $C_L = 1\text{ }\mu\text{F}$, $R_L = 10\text{ }\Omega$				3.4	ms	
		$V_{I(IN)} = 2.7\text{ V}$, $T_J = 25^\circ\text{C}$, $C_L = 1\text{ }\mu\text{F}$, $R_L = 10\text{ }\Omega$				3		

(1) Pulse-testing techniques maintain junction temperature close to ambient temperature; thermal effects must be taken into account separately.

ENABLE INPUT (EN)								
PARAMETER		TEST CONDITIONS			MIN	TYP	MAX	UNIT
V_{IH}	high-level input voltage	$2.7\text{ V} \leq V_{I(IN)} \leq 5.5\text{ V}$			2			V
V_{IL}	Low-level input voltage	$4.5\text{ V} \leq V_{I(IN)} \leq 5.5\text{ V}$					0.8	V
		$2.7\text{ V} \leq V_{I(IN)} \leq 4.5\text{ V}$					0.5	
I_i	Input current	$EN = 0\text{ V}$ or $EN = V_{I(IN)}$			-0.5		0.5	μA
t_{on}	Turnon time	$C_L = 100\text{ }\mu\text{F}$, $R_L = 10\text{ }\Omega$					20	ms
t_{off}	Turnoff time	$C_L = 100\text{ }\mu\text{F}$, $R_L = 10\text{ }\Omega$					40	

CURRENT LIMIT								
PARAMETER		TEST CONDITIONS ⁽¹⁾			MIN	TYP	MAX	UNIT
I_{OS}	Short-circuit output current	$T_J = 25^\circ\text{C}$, $V_I = 5.5\text{ V}$, OUT connected to GND, Device enable into short circuit	TPS2030	0.22	0.3	0.4	A	
			TPS2031	0.66	0.9	1.1		
			TPS2032	1.1	1.5	1.8		
			TPS2033	1.65	2.2	2.7		
			TPS2034	2.2	3	3.8		

(1) Pulse-testing techniques maintain junction temperature close to ambient temperature; thermal effects must be taken into account separately.

ELECTRICAL CHARACTERISTICS (Continued)

over recommended operating junction temperature range, $V_{I(IN)} = 5.5\text{ V}$, $I_O =$ rated current, $EN = 5\text{ V}$ (unless otherwise noted)

SUPPLY CURRENT							
PARAMETER	TEST CONDITIONS			MIN	TYP	MAX	UNIT
Supply current, low-level output	No Load on OUT	EN = 0	$T_J = 25^\circ\text{C}$	0.3	1	μA	
			$40^\circ\text{C} \leq T_J \leq 125^\circ\text{C}$		10		
Supply current, high-level output	No Load on OUT	EN = $V_{I(IN)}$	$T_J = 25^\circ\text{C}$	58	75	μA	
			$40^\circ\text{C} \leq T_J \leq 125^\circ\text{C}$	75	100		
Leakage current	OUT connected to ground	EN = 0	$40^\circ\text{C} \leq T_J \leq 125^\circ\text{C}$	10		μA	
UNDERVOLTAGE LOCKOUT							
PARAMETER	TEST CONDITIONS			MIN	TYP	MAX	UNIT
Low-level input voltage				2		2.5	V
Hysteresis	$T_J = 25^\circ\text{C}$				100		mV
OVERCURRENT ($\overline{\text{OC}}$)							
Output low voltage	$I_O = 10\text{ mA}$, $V_{OL(\overline{\text{OC}})}$					0.4	V
Off-state current ⁽¹⁾	$V_O = 5\text{ V}$, $V_O = 3.3\text{ V}$					1	μA

(1) Specified by design, not production tested.

PARAMETER MEASUREMENT INFORMATION

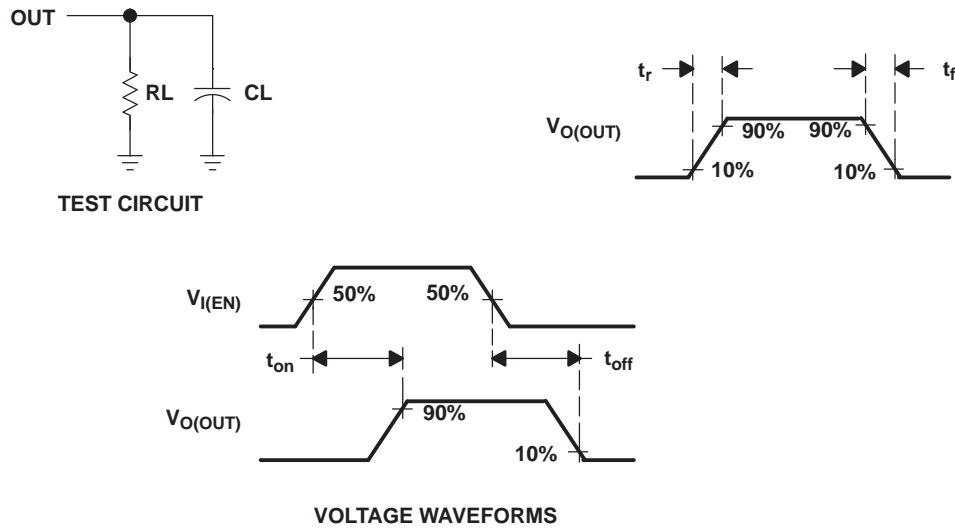

Figure 1. Test Circuit and Voltage Waveforms

TABLE OF TIMING DIAGRAMS

	FIGURE
Turnon Delay and Rise Time	2
Turnoff Delay and Fall Time	3
Turnon Delay and Rise Time with 1- μ F Load	4
Turnoff Delay and Rise TIME with 1- μ F Load	5
Device Enabled Into Short	6
TPS2030, TPS2031, TPS2032, TPS2033, and TPS2034, Ramped Load on Enabled Device	7, 8, 9, 10, 11
TPS2034, Inrush Current	12
7.9- Ω Load Connected to an Enabled TPS2030 Device	13
3.7- Ω Load Connected to an Enabled TPS2030 Device	14
3.7- Ω Load Connected to an Enabled TPS2031 Device	15
2.6- Ω Load Connected to an Enabled TPS2031 Device	16
2.6- Ω Load Connected to an Enabled TPS2032 Device	17
1.2- Ω Load Connected to an Enabled TPS2032 Device	18
1.2- Ω Load Connected to an Enabled TPS2033 Device	19
0.9- Ω Load Connected to an Enabled TPS2033 Device	20
0.9- Ω Load Connected to an Enabled TPS2034 Device	21
0.5- Ω Load Connected to an Enabled TPS2034 Device	22

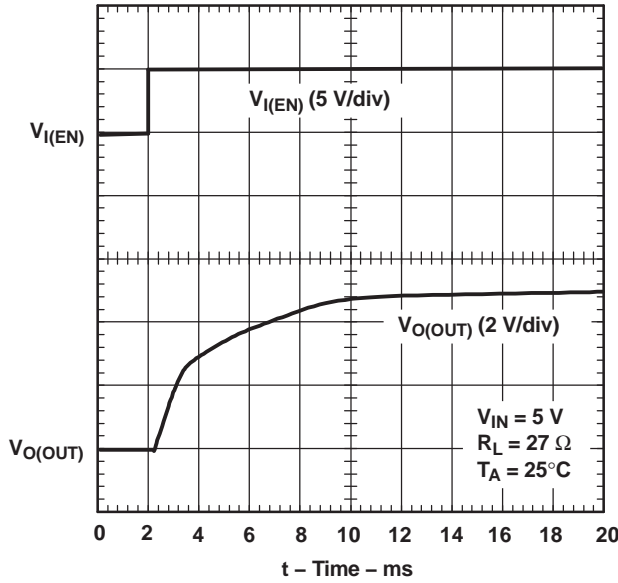

Figure 2. Turnon Delay and Rise Time

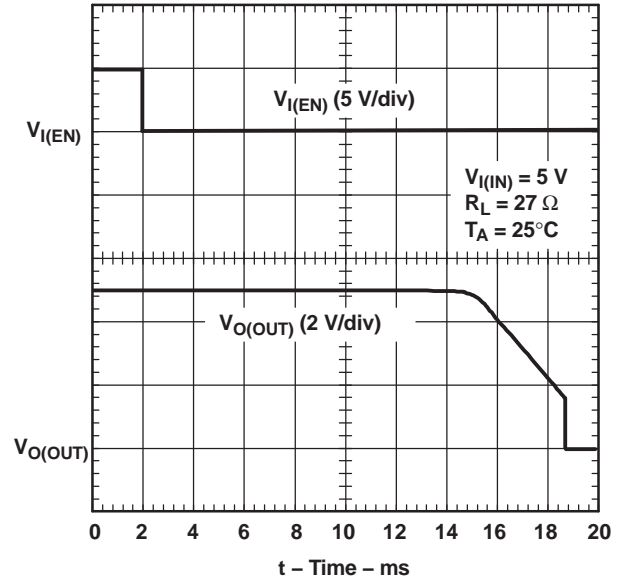

Figure 3. Turnoff Delay and Fall Time

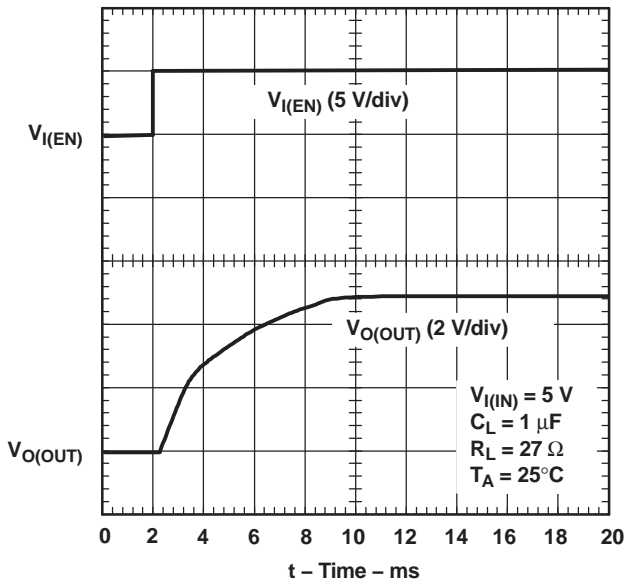

Figure 4. Turnon Delay and Rise Time With 1- μ F Load

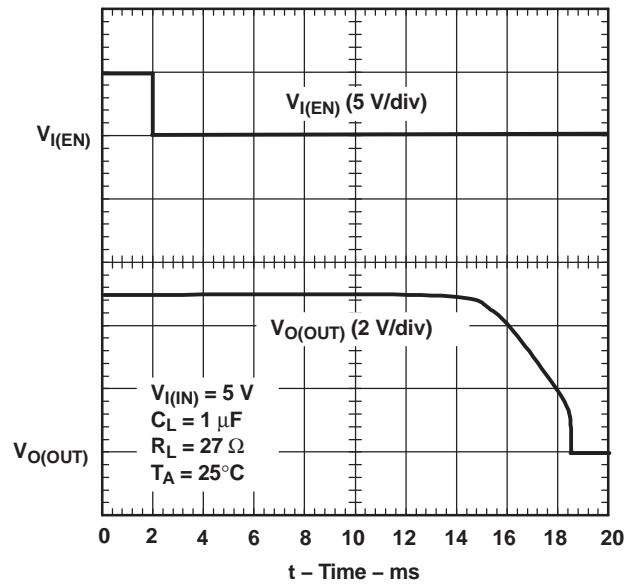

Figure 5. Turnoff Delay and Fall Time With 1- μ F Load

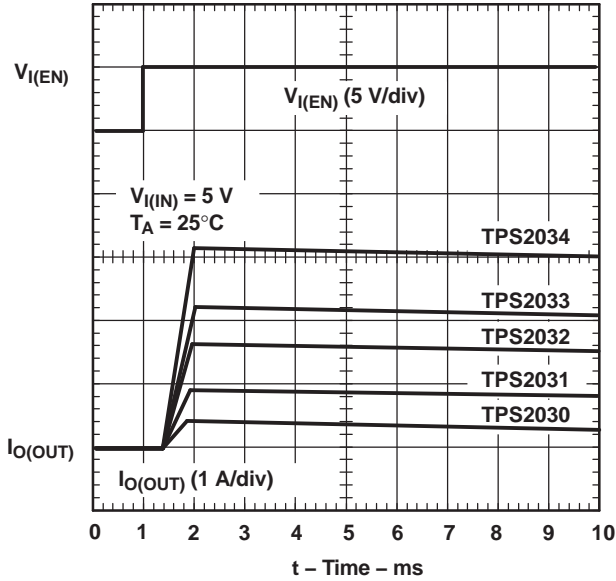

Figure 6. Device Enabled Into Short

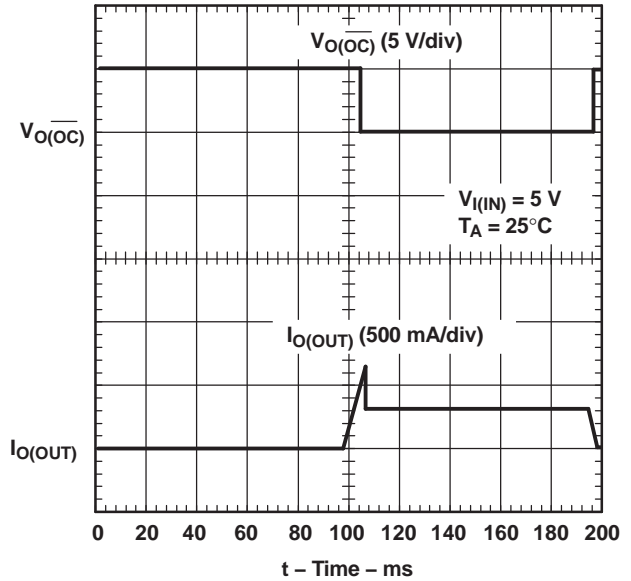

Figure 7. TPS2030, Ramped Load on Enabled Device

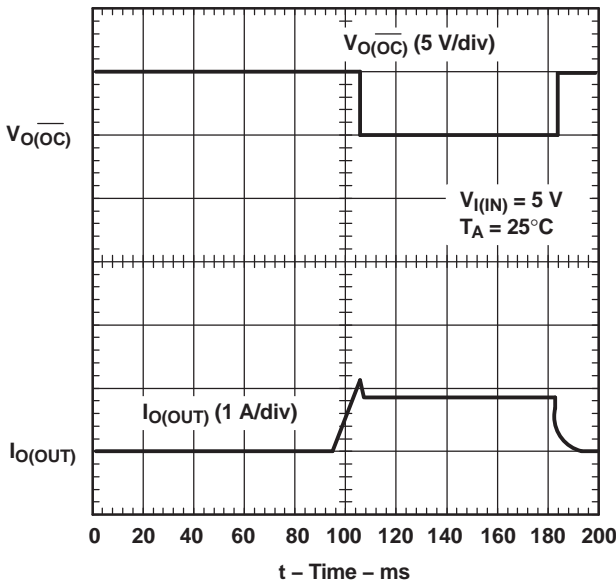

Figure 8. TPS2031, Ramped Load on Enabled Device

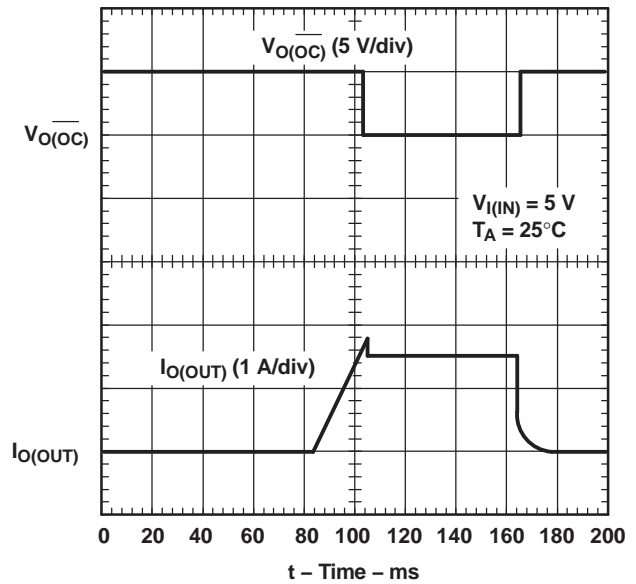

Figure 9. TPS2032, Ramped Load on Enabled Device

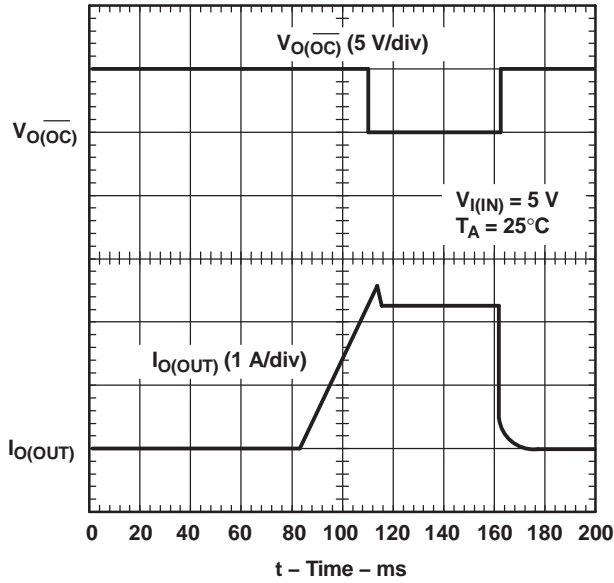

Figure 10. TPS2033, Ramped Load on Enabled Device

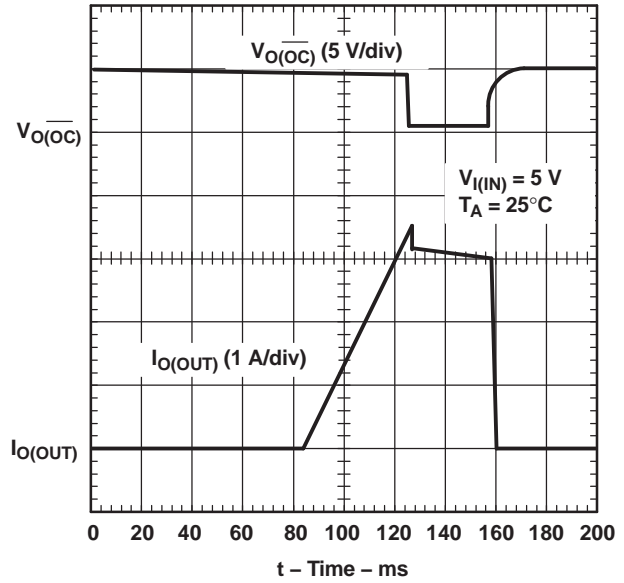

Figure 11. TPS2034, Ramped Load on Enabled Device

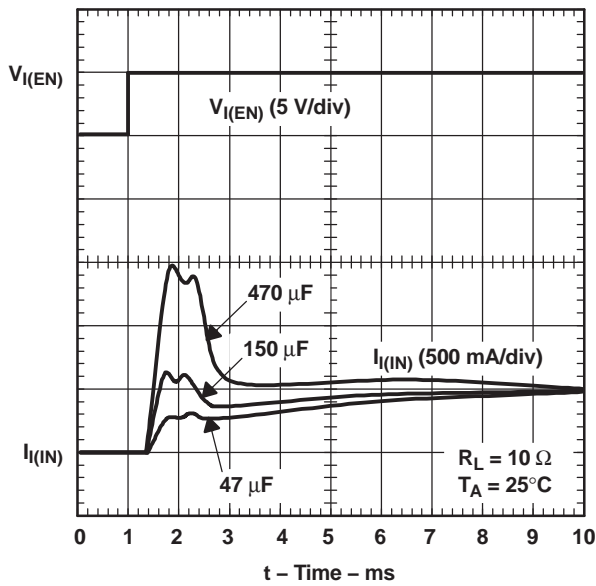

Figure 12. TPS2034, Inrush Current

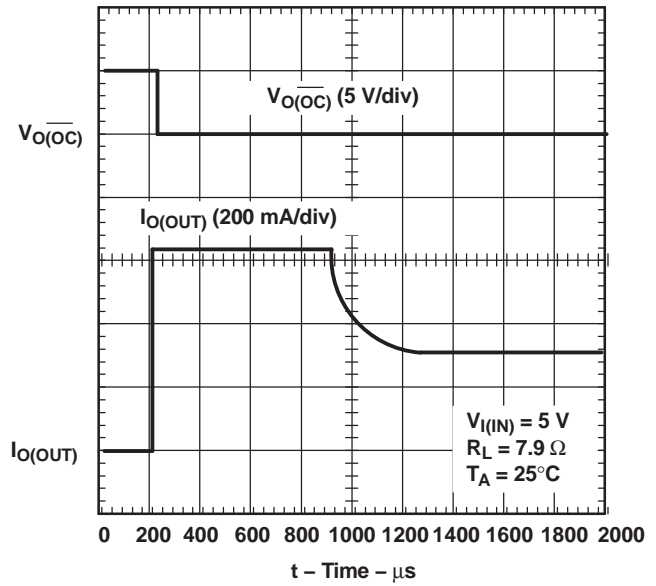

Figure 13. 7.9-Ω Load Connected to an Enabled TPS2030 Device

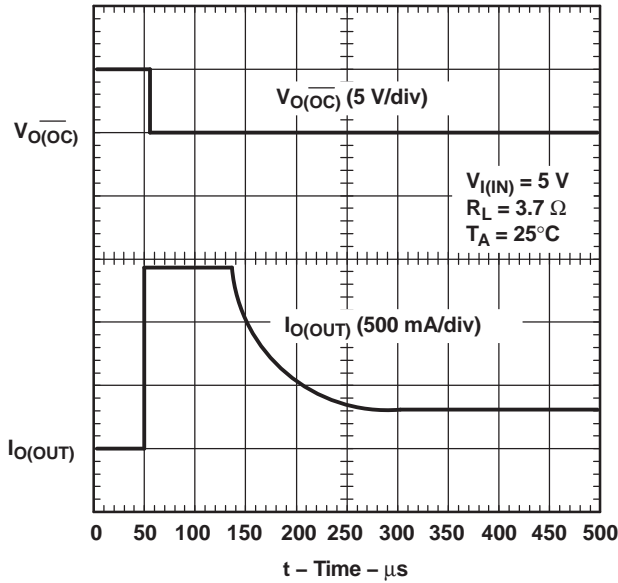

Figure 14. 3.7- Ω Load Connected to an Enabled TPS2030 Device

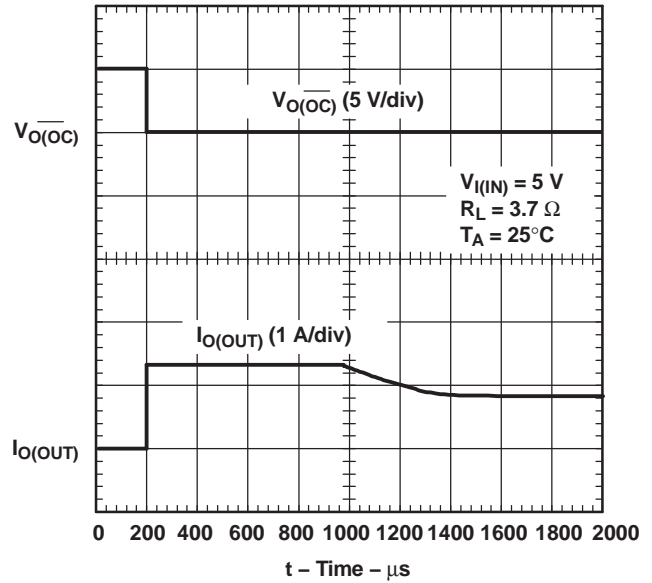

Figure 15. 3.7- Ω Load Connected to an Enabled TPS2031 Device

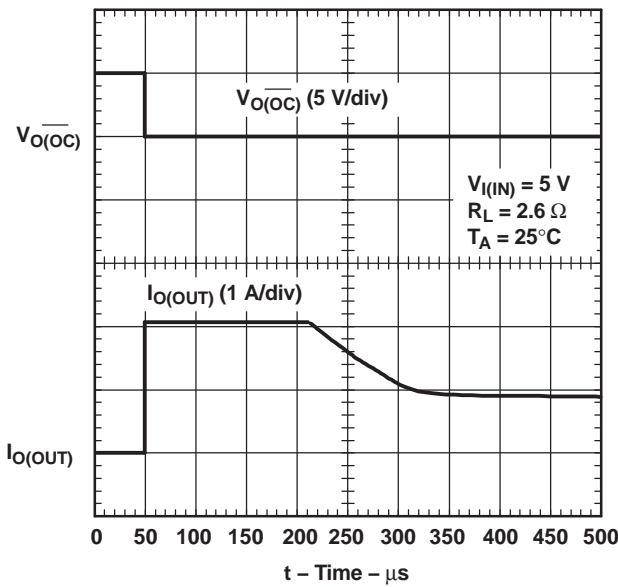

Figure 16. 2.6- Ω Load Connected to an Enabled TPS2031 Device

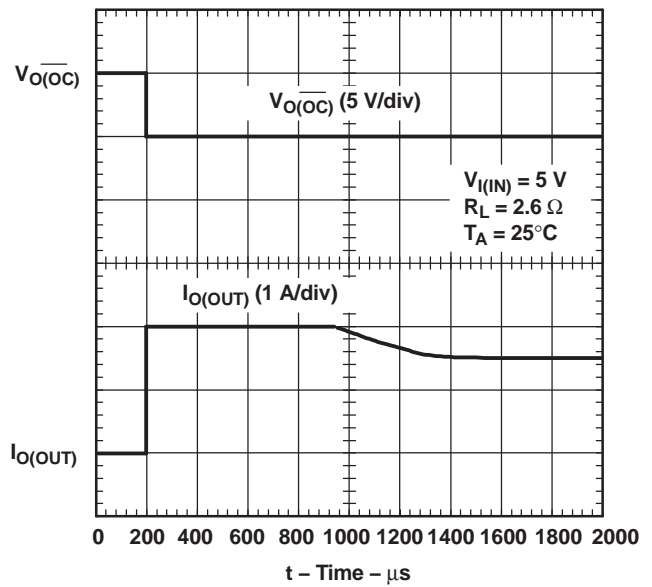

Figure 17. 2.6- Ω Load Connected to an Enabled TPS2032 Device

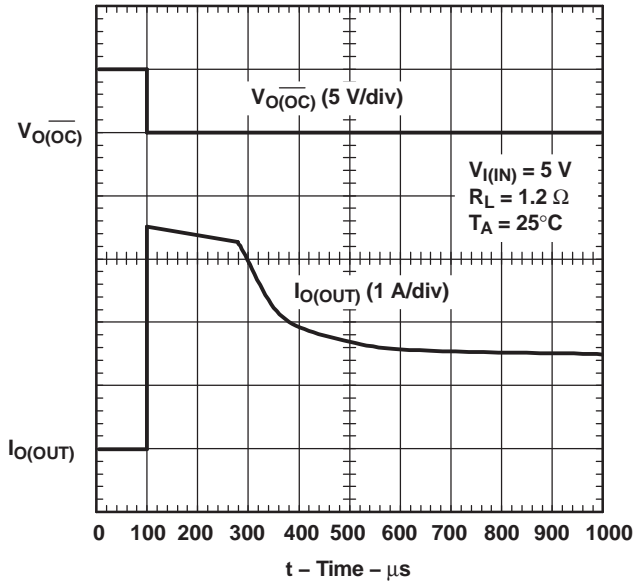

Figure 18. 1.2-Ω Load Connected to an Enabled TPS2032 Device

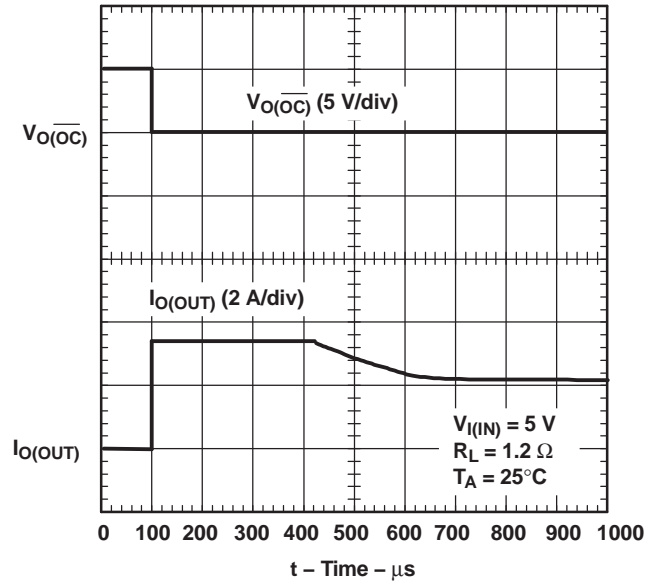

Figure 19. 1.2-Ω Load Connected to an Enabled TPS2033 Device

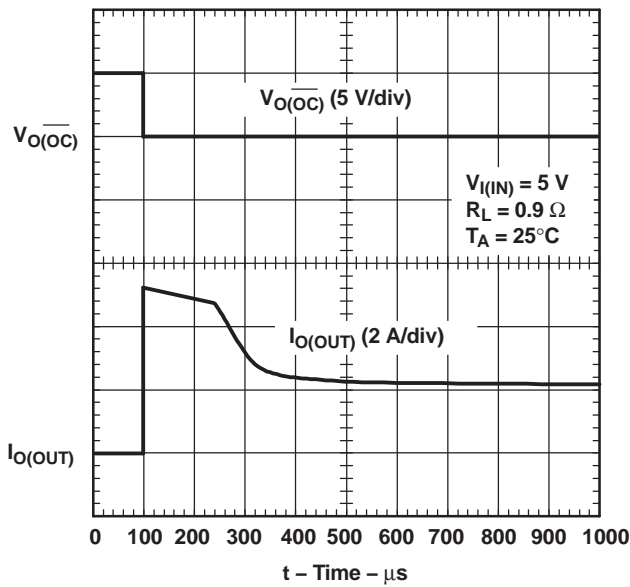

Figure 20. 0.9-Ω Load Connected to an Enabled TPS2033 Device

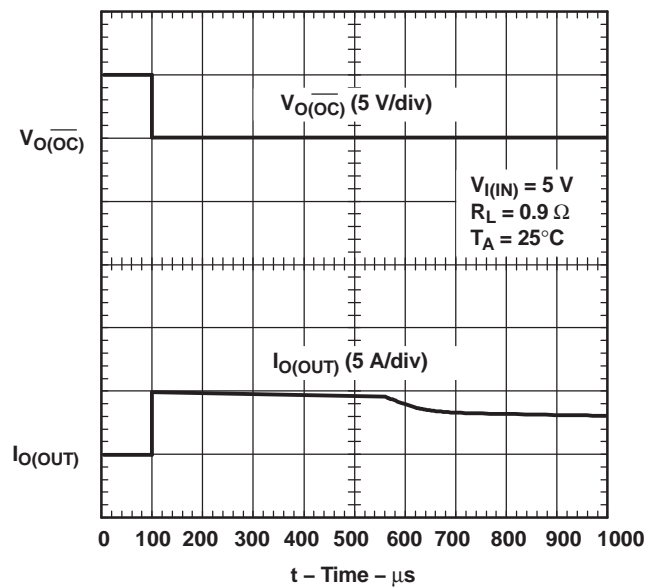

Figure 21. 0.9-Ω Load Connected to an Enabled TPS2034 Device

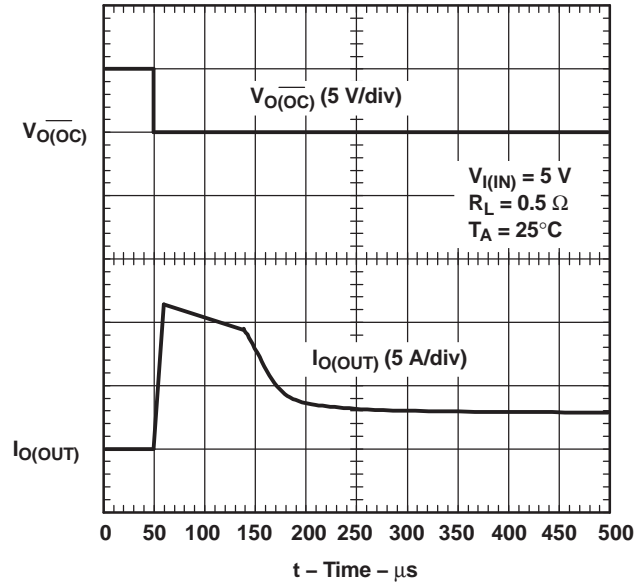
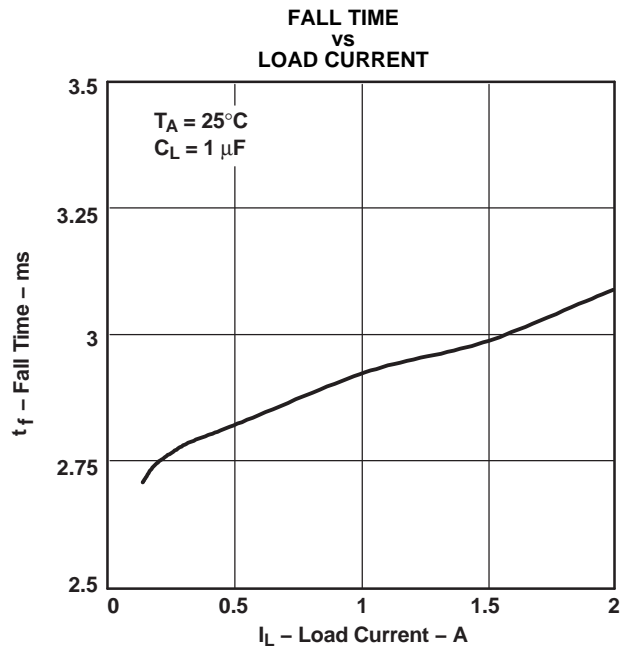
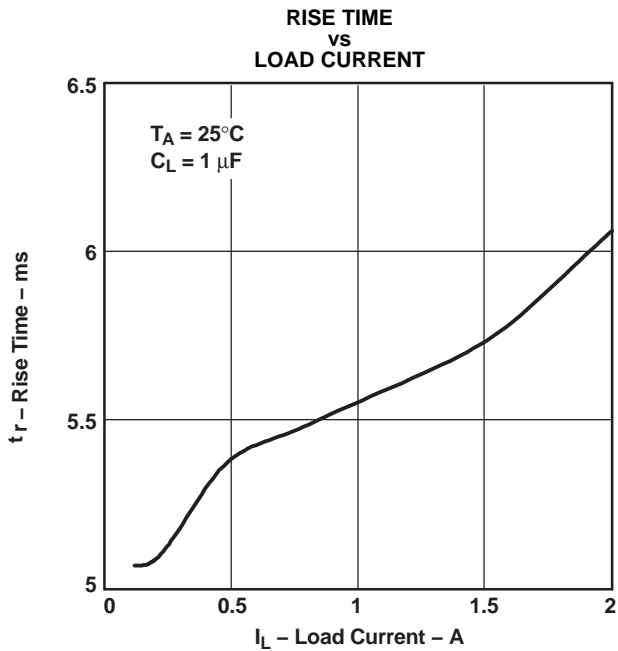
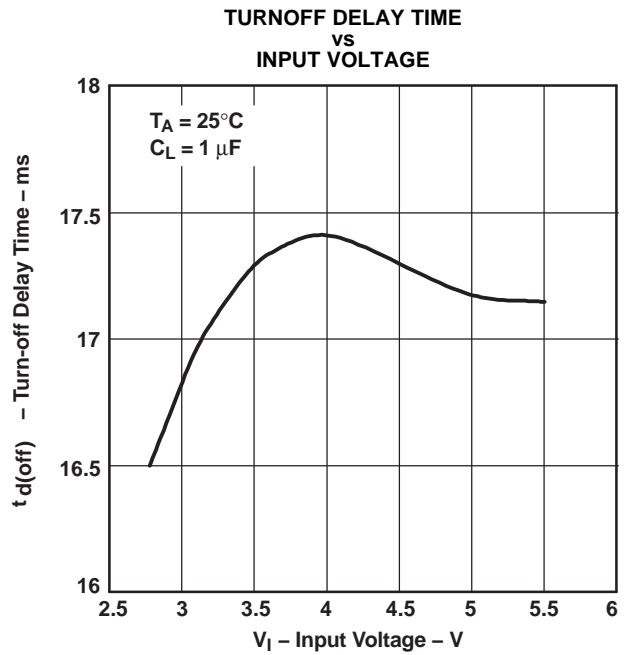
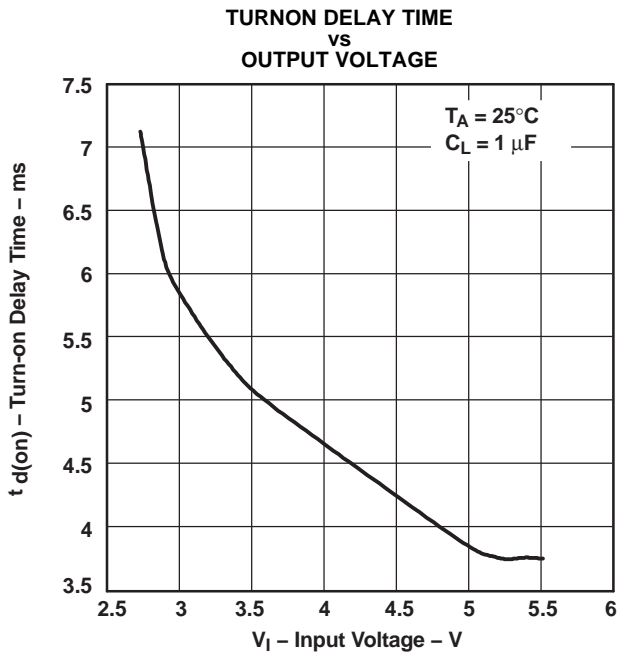

Figure 22. 0.5- Ω Load Connected to an Enabled TPS2034 Device

TYPICAL CHARACTERISTICS

TABLE OF GRAPHS

			FIGURE
$t_{d(on)}$	Turnon delay time	vs Output voltage	23
$t_{d(off)}$	Turnoff delay time	vs Input voltage	24
t_r	Rise time	vs Load current	25
t_f	Fall time	vs Load current	26
	Supply current (enabled)	vs Junction temperature	27
	Supply current (disabled)	vs Junction temperature	28
	Supply current (enabled)	vs Input voltage	29
	Supply current (disabled)	vs Input voltage	30
I_{OS}	Short-circuit current limit	vs Input voltage	31
		vs Junction temperature	32
$r_{DS(on)}$	Static drain-source on-state resistance	vs Input voltage	33
		vs Junction temperature	34
		vs Input voltage	35
		vs Junction temperature	36
V_I	Input voltage	Undervoltage lockout	37



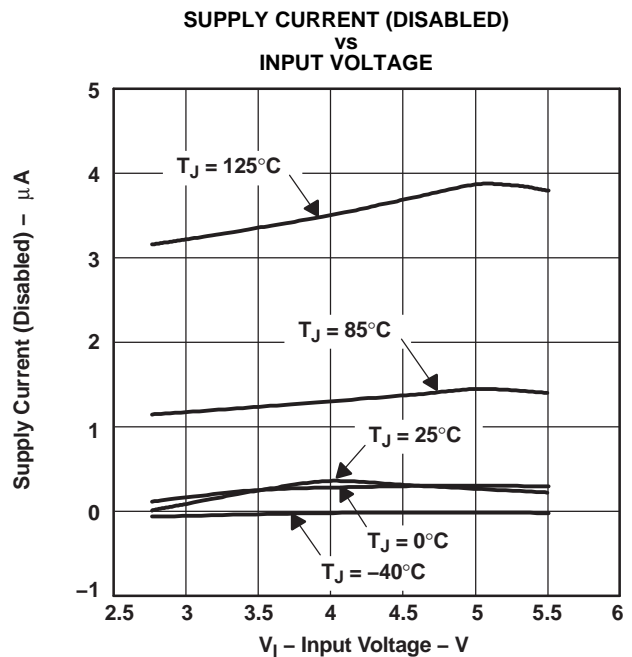
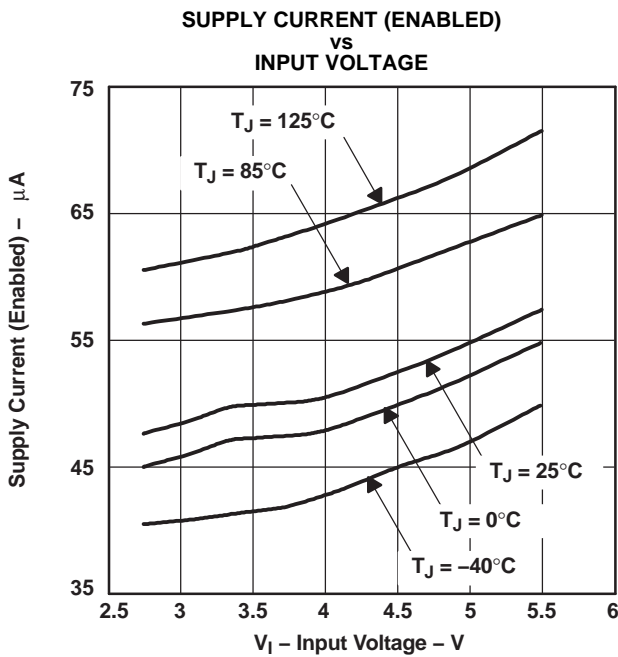
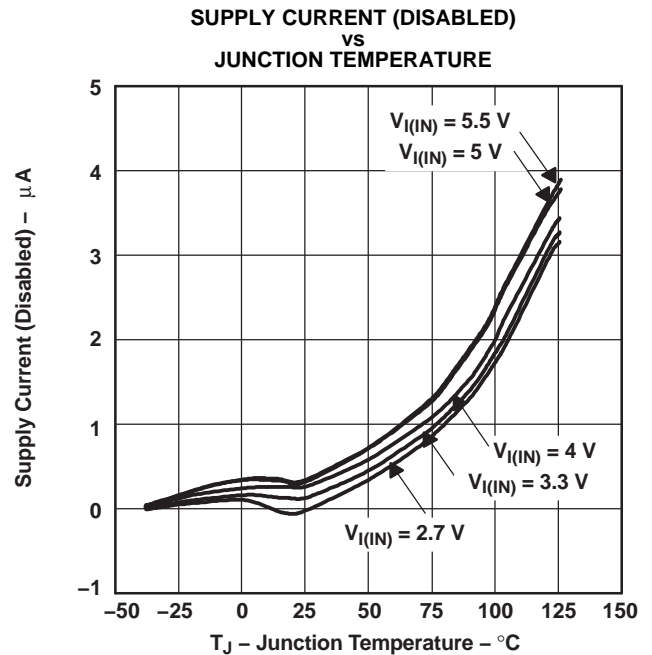
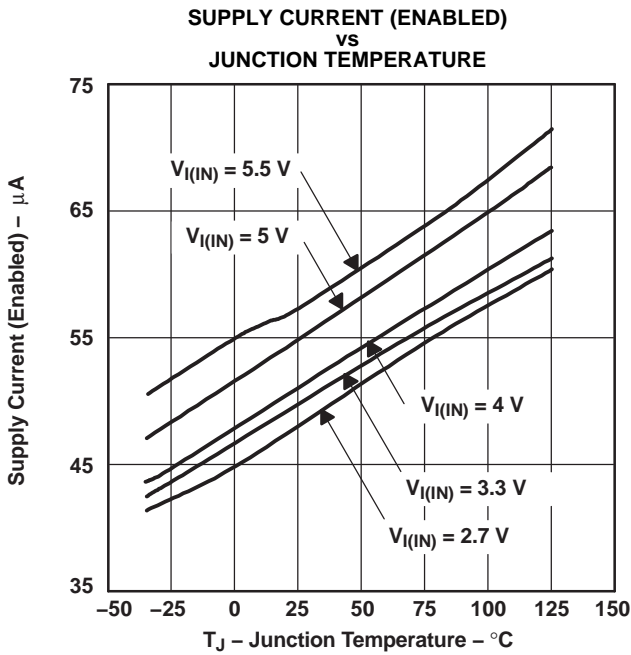

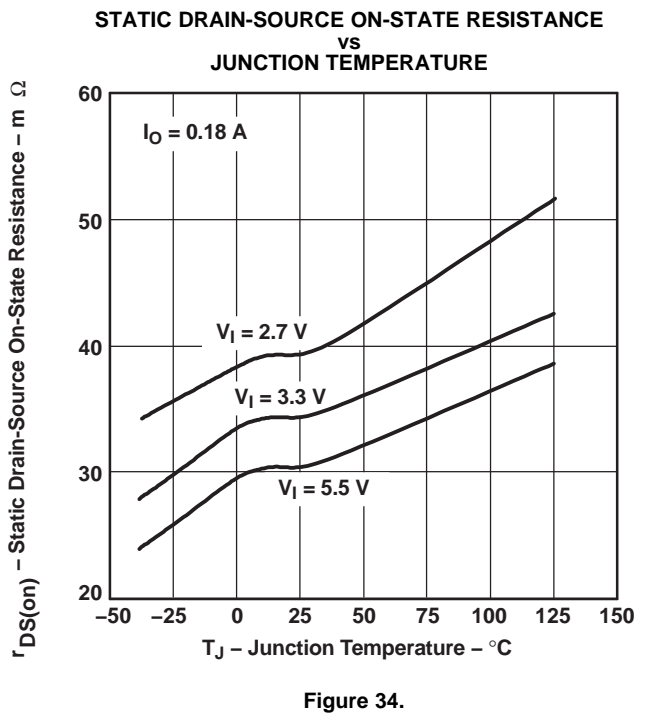
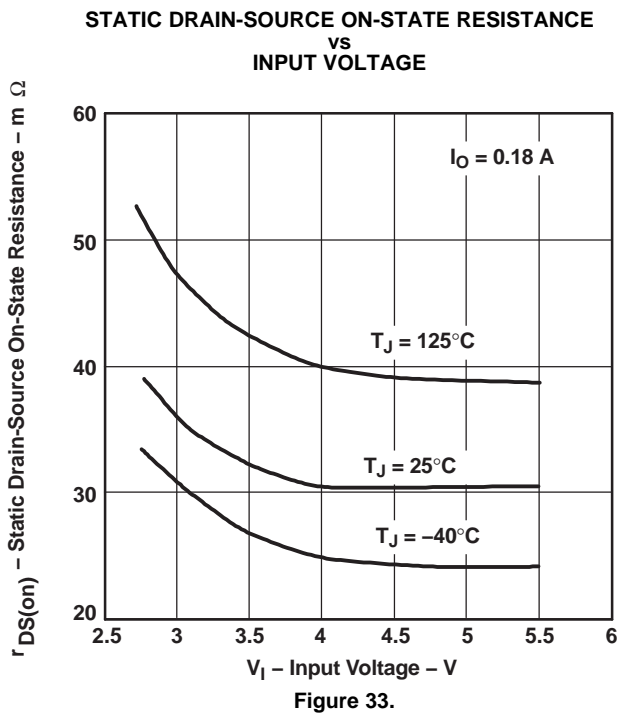
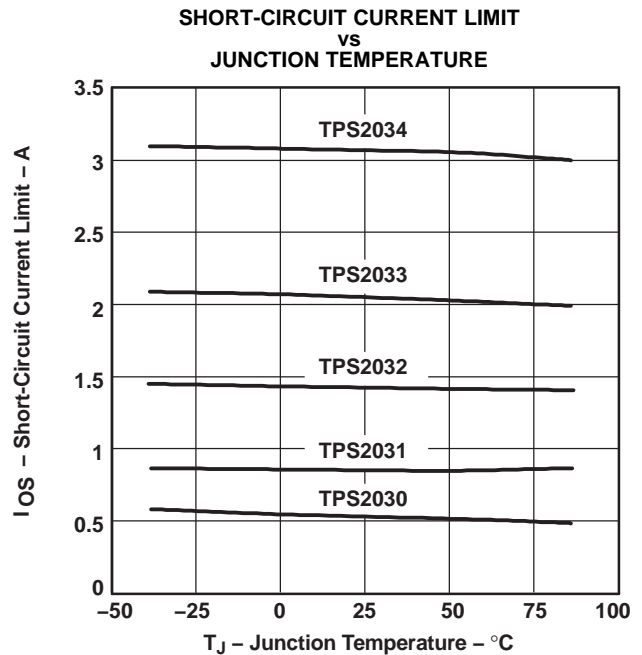
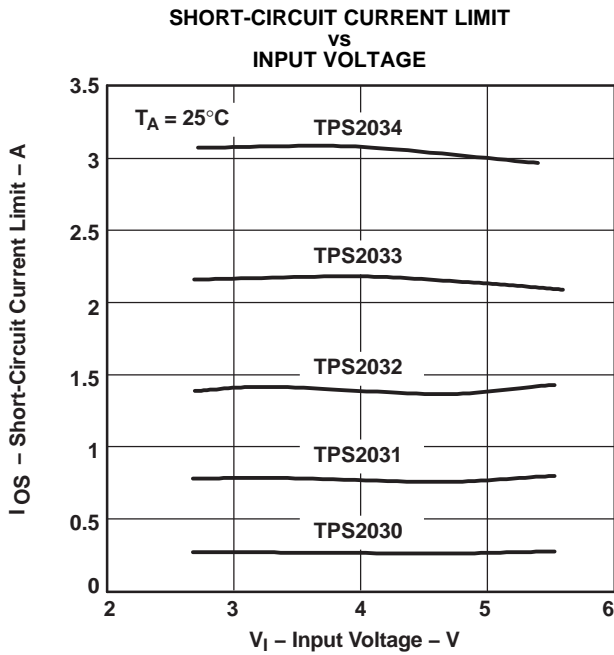

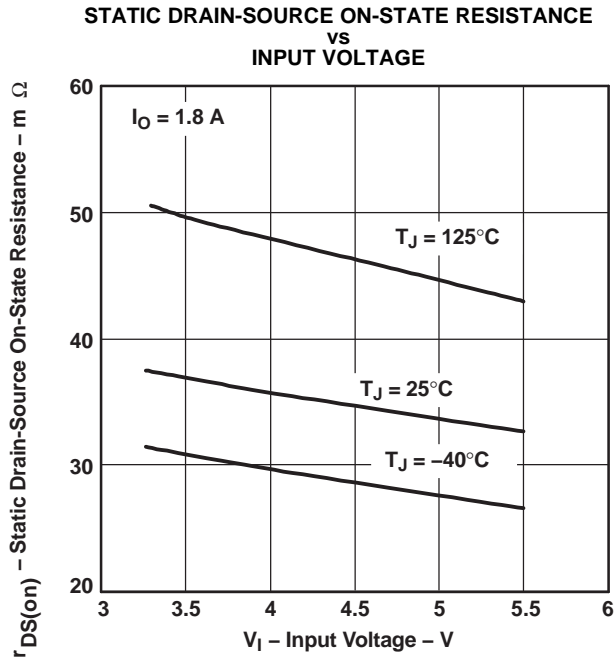

Figure 35.

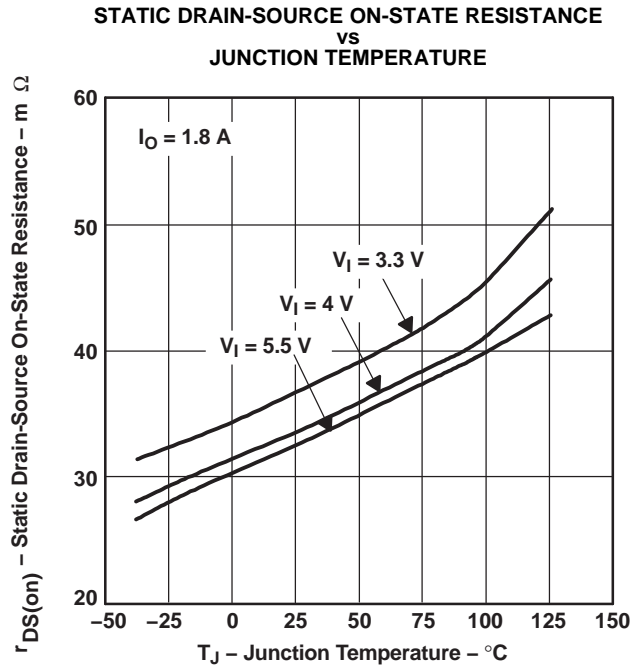

Figure 36.

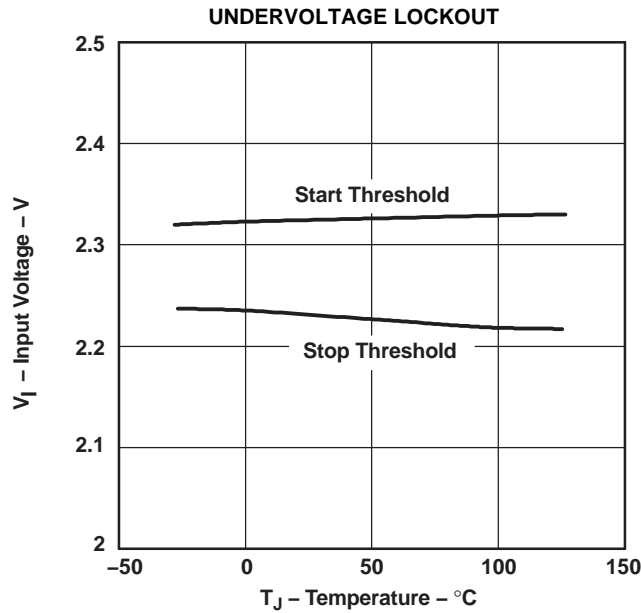

Figure 37.

APPLICATION INFORMATION

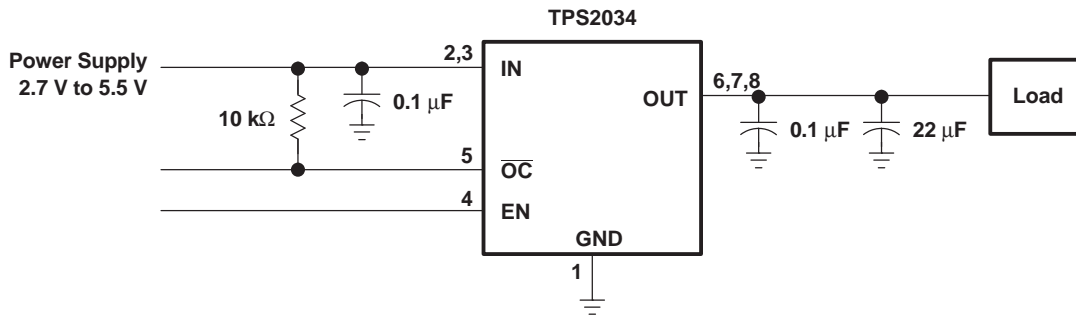

Figure 38. Typical Application

POWER SUPPLY CONSIDERATIONS

A 0.01- μF to 0.1- μF ceramic bypass capacitor between IN and GND, close to the device, is recommended. Placing a high-value electrolytic capacitor on the output and input pins is recommended when the output load is heavy. This precaution reduces power supply transients that may cause ringing on the input. Additionally, bypassing the output with a 0.01- μF to 0.1- μF ceramic capacitor improves the immunity of the device to short-circuit transients.

OVERCURRENT

A sense FET checks for overcurrent conditions. Unlike current-sense resistors, sense FETs do not increase the series resistance of the current path. When an overcurrent condition is detected, the device maintains a constant output current and reduces the output voltage accordingly. Complete shutdown occurs only if the fault is present long enough to activate thermal limiting.

Three possible overload conditions can occur. In the first condition, the output has been shorted before the device is enabled or before $V_{I(IN)}$ has been applied (see Figure 6). The TPS203x senses the short and immediately switches into a constant-current output.

In the second condition, the excessive load occurs while the device is enabled. At the instant the excessive load occurs, very high currents may flow for a short time before the current-limit circuit can react (see Figure 13 through Figure 22). After the current-limit circuit has tripped (reached the overcurrent trip threshold) the device switches into constant-current mode.

In the third condition, the load has been gradually increased beyond the recommended operating current. The current is permitted to rise until the current-limit threshold is reached or until the thermal limit of the device is exceeded (see Figure 7 through Figure 11). The TPS203x is capable of delivering current up to the current-limit threshold without damaging the device. Once the threshold has been reached, the device switches into its constant-current mode.

$\overline{\text{OC}}$ RESPONSE

The $\overline{\text{OC}}$ open-drain output is asserted (active low) when an overcurrent or overtemperature condition is encountered. The output will remain asserted until the overcurrent or overtemperature condition is removed. Connecting a heavy capacitive load to an enabled device can cause momentary false overcurrent reporting from the inrush current flowing through the device, charging the downstream capacitor. An RC filter can be connected to the $\overline{\text{OC}}$ pin to reduce false overcurrent reporting. Using low-ESR electrolytic capacitors on the output lowers the inrush current flow through the device during hot-plug events by providing a low impedance energy source, thereby reducing erroneous overcurrent reporting.

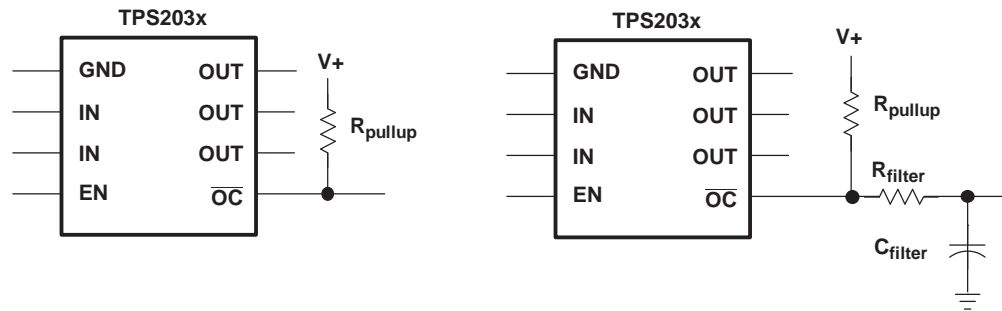

Figure 39. Typical Circuit for \overline{OC} Pin and RC Filter for Damping Inrush \overline{OC} Responses

POWER DISSIPATION AND JUNCTION TEMPERATURE

The low on-resistance on the n-channel MOSFET allows small surface-mount packages, such as SOIC, to pass large currents. The thermal resistances of these packages are high compared to those of power packages; it is good design practice to check power dissipation and junction temperature. The first step is to find $r_{DS(on)}$ at the input voltage and operating temperature. As an initial estimate, use the highest operating ambient temperature of interest and read $r_{DS(on)}$ from [Figure 33](#) through [Figure 36](#). Next, calculate the power dissipation using:

$$P_D = r_{DS(on)} \times I^2 \quad (1)$$

Finally, calculate the junction temperature:

$$T_J = P_D \times R_{\theta JA} + T_A \quad (2)$$

Where:

T_A = Ambient Temperature °C

$R_{\theta JA}$ = Thermal resistance SOIC = 172°C/W, PDIP = 106°C/W

Compare the calculated junction temperature with the initial estimate. If they do not agree within a few degrees, repeat the calculation, using the calculated value as the new estimate. Two or three iterations are generally sufficient to get an acceptable answer.

THERMAL PROTECTION

Thermal protection prevents damage to the IC when heavy-overload or short-circuit faults are present for extended periods of time. The faults force the TPS203x into constant current mode, which causes the voltage across the high-side switch to increase; under short-circuit conditions, the voltage across the switch is equal to the input voltage. The increased dissipation causes the junction temperature to rise to high levels. The protection circuit senses the junction temperature of the switch and shuts it off. Hysteresis is built into the thermal sense circuit, and after the device has cooled approximately 20 degrees, the switch turns back on. The switch continues to cycle in this manner until the load fault or input power is removed.

UNDERVOLTAGE LOCKOUT (UVLO)

An undervoltage lockout ensures that the power switch is in the off state at powerup. Whenever the input voltage falls below approximately 2 V, the power switch is quickly turned off. This facilitates the design of hot-insertion systems where it is not possible to turn off the power switch before input power is removed. The UVLO also keeps the switch from being turned on until the power supply has reached at least 2 V, even if the switch is enabled. Upon reinsertion, the power switch will be turned on, with a controlled rise time to reduce EMI and voltage overshoots.

GENERIC HOT-PLUG APPLICATIONS (Figure 40)

In many applications it may be necessary to remove modules or pc boards while the main unit is still operating. These are considered hot-plug applications. Such implementations require the control of current surges seen by the main power supply and the card being inserted. The most effective way to control these surges is to limit and slowly ramp the current and voltage being applied to the card, similar to the way in which a power supply normally turns on. Because of the controlled rise times and fall times of the TPS203x series, these devices can be used to provide a softer start-up to devices being hot-plugged into a powered system. The UVLO feature of the TPS203x also ensures the switch will be off after the card has been removed, and the switch will be off during the next insertion. The UVLO feature ensures a soft start with a controlled rise time for every insertion of the card or module.

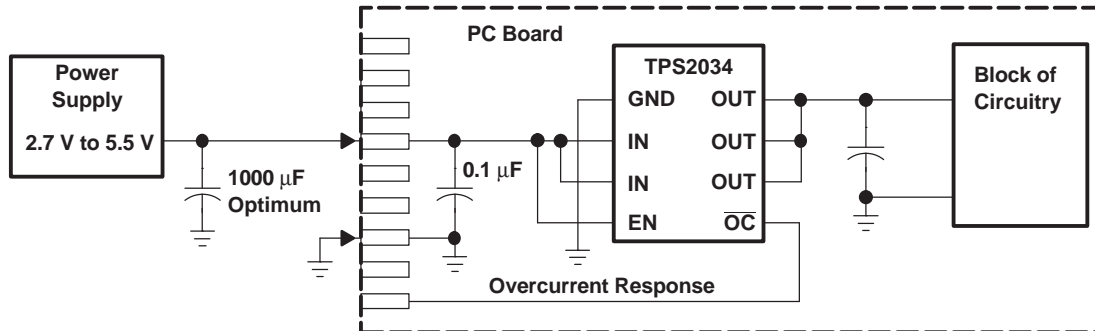

Figure 40. Typical Hot-Plug Implementation

By placing the TPS203x between the V_{CC} input and the rest of the circuitry, the input power will reach this device first after insertion. The typical rise time of the switch is approximately 9 ms, providing a slow voltage ramp at the output of the device. This implementation controls system surge currents and provides a hot-plugging mechanism for any device.

PACKAGING INFORMATION

Orderable Device	Status (1)	Package Type	Package Drawing	Pins	Package Qty	Eco Plan (2)	Lead/Ball Finish (6)	MSL Peak Temp (3)	Op Temp (°C)	Device Marking (4/5)	Samples
TPS2030D	ACTIVE	SOIC	D	8	75	Green (RoHS & no Sb/Br)	CU NIPDAU	Level-1-260C-UNLIM		2030	Samples
TPS2030DG4	ACTIVE	SOIC	D	8	75	Green (RoHS & no Sb/Br)	CU NIPDAU	Level-1-260C-UNLIM		2030	Samples
TPS2030DR	ACTIVE	SOIC	D	8	2500	Green (RoHS & no Sb/Br)	CU NIPDAU	Level-1-260C-UNLIM		2030	Samples
TPS2030DRG4	ACTIVE	SOIC	D	8	2500	Green (RoHS & no Sb/Br)	CU NIPDAU	Level-1-260C-UNLIM		2030	Samples
TPS2030P	ACTIVE	PDIP	P	8	50	Pb-Free (RoHS)	CU NIPDAU	N / A for Pkg Type		TPS2030P	Samples
TPS2031D	ACTIVE	SOIC	D	8	75	Green (RoHS & no Sb/Br)	CU NIPDAU	Level-1-260C-UNLIM		2031	Samples
TPS2031DG4	ACTIVE	SOIC	D	8	75	Green (RoHS & no Sb/Br)	CU NIPDAU	Level-1-260C-UNLIM		2031	Samples
TPS2031DR	ACTIVE	SOIC	D	8	2500	Green (RoHS & no Sb/Br)	CU NIPDAU	Level-1-260C-UNLIM		2031	Samples
TPS2031DRG4	ACTIVE	SOIC	D	8	2500	Green (RoHS & no Sb/Br)	CU NIPDAU	Level-1-260C-UNLIM		2031	Samples
TPS2031P	ACTIVE	PDIP	P	8	50	Pb-Free (RoHS)	CU NIPDAU	N / A for Pkg Type		TPS2031P	Samples
TPS2032D	ACTIVE	SOIC	D	8	75	Green (RoHS & no Sb/Br)	CU NIPDAU	Level-1-260C-UNLIM		2032	Samples
TPS2032DG4	ACTIVE	SOIC	D	8	75	Green (RoHS & no Sb/Br)	CU NIPDAU	Level-1-260C-UNLIM		2032	Samples
TPS2032DR	ACTIVE	SOIC	D	8	2500	Green (RoHS & no Sb/Br)	CU NIPDAU	Level-1-260C-UNLIM		2032	Samples
TPS2032DRG4	ACTIVE	SOIC	D	8	2500	Green (RoHS & no Sb/Br)	CU NIPDAU	Level-1-260C-UNLIM		2032	Samples
TPS2033D	ACTIVE	SOIC	D	8	75	Green (RoHS & no Sb/Br)	CU NIPDAU	Level-1-260C-UNLIM	-40 to 85	2033	Samples
TPS2033DG4	ACTIVE	SOIC	D	8	75	Green (RoHS & no Sb/Br)	CU NIPDAU	Level-1-260C-UNLIM	-40 to 85	2033	Samples
TPS2033DR	ACTIVE	SOIC	D	8	2500	Green (RoHS & no Sb/Br)	CU NIPDAU	Level-1-260C-UNLIM	-40 to 85	2033	Samples

Orderable Device	Status (1)	Package Type	Package Drawing	Pins	Package Qty	Eco Plan (2)	Lead/Ball Finish (6)	MSL Peak Temp (3)	Op Temp (°C)	Device Marking (4/5)	Samples
TPS2033DRG4	ACTIVE	SOIC	D	8	2500	Green (RoHS & no Sb/Br)	CU NIPDAU	Level-1-260C-UNLIM	-40 to 85	2033	Samples
TPS2034D	ACTIVE	SOIC	D	8	75	Green (RoHS & no Sb/Br)	CU NIPDAU	Level-1-260C-UNLIM	-40 to 85	2034	Samples
TPS2034DG4	ACTIVE	SOIC	D	8	75	Green (RoHS & no Sb/Br)	CU NIPDAU	Level-1-260C-UNLIM	-40 to 85	2034	Samples
TPS2034DR	ACTIVE	SOIC	D	8	2500	Green (RoHS & no Sb/Br)	CU NIPDAU	Level-1-260C-UNLIM	-40 to 85	2034	Samples
TPS2034DRG4	ACTIVE	SOIC	D	8	2500	Green (RoHS & no Sb/Br)	CU NIPDAU	Level-1-260C-UNLIM	-40 to 85	2034	Samples
TPS2034P	ACTIVE	PDIP	P	8	50	Pb-Free (RoHS)	CU NIPDAU	N / A for Pkg Type	-40 to 85	TPS2034P	Samples

(1) The marketing status values are defined as follows:

ACTIVE: Product device recommended for new designs.

LIFEBUY: TI has announced that the device will be discontinued, and a lifetime-buy period is in effect.

NRND: Not recommended for new designs. Device is in production to support existing customers, but TI does not recommend using this part in a new design.

PREVIEW: Device has been announced but is not in production. Samples may or may not be available.

OBSELETE: TI has discontinued the production of the device.

(2) Eco Plan - The planned eco-friendly classification: Pb-Free (RoHS), Pb-Free (RoHS Exempt), or Green (RoHS & no Sb/Br) - please check <http://www.ti.com/productcontent> for the latest availability information and additional product content details.

TBD: The Pb-Free/Green conversion plan has not been defined.

Pb-Free (RoHS): TI's terms "Lead-Free" or "Pb-Free" mean semiconductor products that are compatible with the current RoHS requirements for all 6 substances, including the requirement that lead not exceed 0.1% by weight in homogeneous materials. Where designed to be soldered at high temperatures, TI Pb-Free products are suitable for use in specified lead-free processes.

Pb-Free (RoHS Exempt): This component has a RoHS exemption for either 1) lead-based flip-chip solder bumps used between the die and package, or 2) lead-based die adhesive used between the die and leadframe. The component is otherwise considered Pb-Free (RoHS compatible) as defined above.

Green (RoHS & no Sb/Br): TI defines "Green" to mean Pb-Free (RoHS compatible), and free of Bromine (Br) and Antimony (Sb) based flame retardants (Br or Sb do not exceed 0.1% by weight in homogeneous material)

(3) MSL, Peak Temp. - The Moisture Sensitivity Level rating according to the JEDEC industry standard classifications, and peak solder temperature.

(4) There may be additional marking, which relates to the logo, the lot trace code information, or the environmental category on the device.

(5) Multiple Device Markings will be inside parentheses. Only one Device Marking contained in parentheses and separated by a "-" will appear on a device. If a line is indented then it is a continuation of the previous line and the two combined represent the entire Device Marking for that device.

⁽⁶⁾ Lead/Ball Finish - Orderable Devices may have multiple material finish options. Finish options are separated by a vertical ruled line. Lead/Ball Finish values may wrap to two lines if the finish value exceeds the maximum column width.

Important Information and Disclaimer:The information provided on this page represents TI's knowledge and belief as of the date that it is provided. TI bases its knowledge and belief on information provided by third parties, and makes no representation or warranty as to the accuracy of such information. Efforts are underway to better integrate information from third parties. TI has taken and continues to take reasonable steps to provide representative and accurate information but may not have conducted destructive testing or chemical analysis on incoming materials and chemicals. TI and TI suppliers consider certain information to be proprietary, and thus CAS numbers and other limited information may not be available for release.

In no event shall TI's liability arising out of such information exceed the total purchase price of the TI part(s) at issue in this document sold by TI to Customer on an annual basis.

OTHER QUALIFIED VERSIONS OF TPS2030, TPS2032 :

- Automotive: [TPS2030-Q1](#), [TPS2032-Q1](#)

NOTE: Qualified Version Definitions:

- Automotive - Q100 devices qualified for high-reliability automotive applications targeting zero defects

TAPE AND REEL INFORMATION

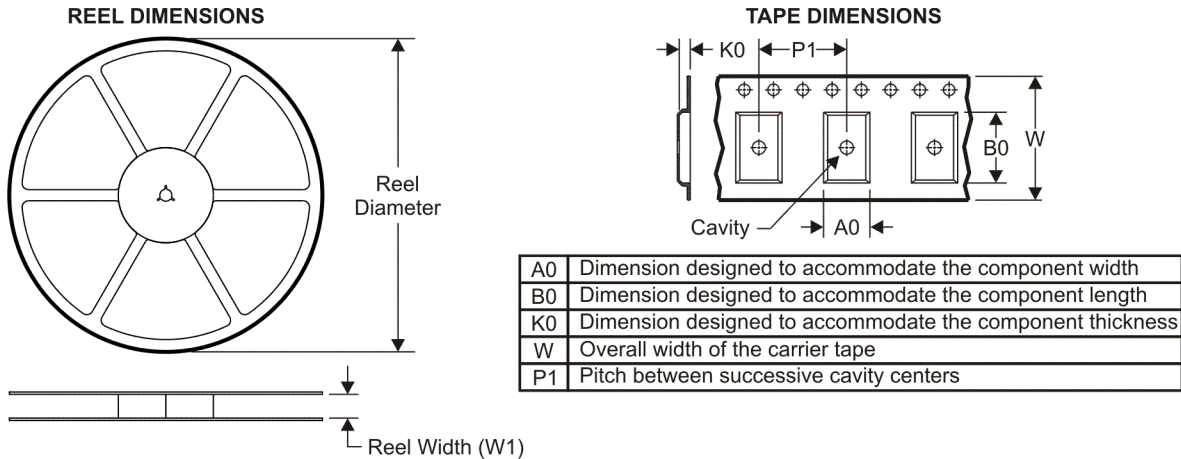

QUADRANT ASSIGNMENTS FOR PIN 1 ORIENTATION IN TAPE

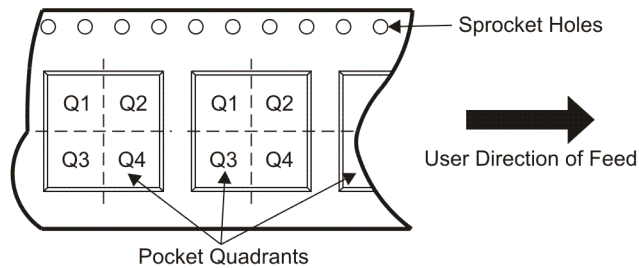

*All dimensions are nominal

Device	Package Type	Package Drawing	Pins	SPQ	Reel Diameter (mm)	Reel Width W1 (mm)	A0 (mm)	B0 (mm)	K0 (mm)	P1 (mm)	W (mm)	Pin1 Quadrant
TPS2030DR	SOIC	D	8	2500	330.0	12.4	6.4	5.2	2.1	8.0	12.0	Q1
TPS2031DR	SOIC	D	8	2500	330.0	12.4	6.4	5.2	2.1	8.0	12.0	Q1
TPS2032DR	SOIC	D	8	2500	330.0	12.4	6.4	5.2	2.1	8.0	12.0	Q1
TPS2033DR	SOIC	D	8	2500	330.0	12.4	6.4	5.2	2.1	8.0	12.0	Q1
TPS2034DR	SOIC	D	8	2500	330.0	12.4	6.4	5.2	2.1	8.0	12.0	Q1

TAPE AND REEL BOX DIMENSIONS

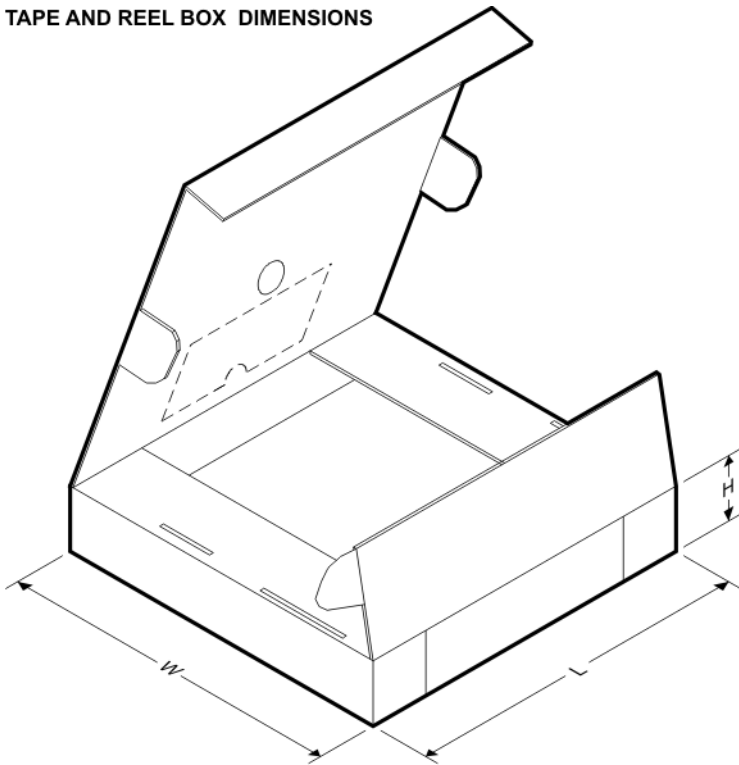

*All dimensions are nominal

Device	Package Type	Package Drawing	Pins	SPQ	Length (mm)	Width (mm)	Height (mm)
TPS2030DR	SOIC	D	8	2500	340.5	338.1	20.6
TPS2031DR	SOIC	D	8	2500	340.5	338.1	20.6
TPS2032DR	SOIC	D	8	2500	340.5	338.1	20.6
TPS2033DR	SOIC	D	8	2500	340.5	338.1	20.6
TPS2034DR	SOIC	D	8	2500	340.5	338.1	20.6

P (R-PDIP-T8)

PLASTIC DUAL-IN-LINE PACKAGE



- NOTES:
- A. All linear dimensions are in inches (millimeters).
 - B. This drawing is subject to change without notice.
 - C. Falls within JEDEC MS-001 variation BA.

D (R-PDSO-G8)

PLASTIC SMALL OUTLINE



- NOTES:
- A. All linear dimensions are in millimeters.
 - B. This drawing is subject to change without notice.
 - C. Publication IPC-7351 is recommended for alternate designs.
 - D. Laser cutting apertures with trapezoidal walls and also rounding corners will offer better paste release. Customers should contact their board assembly site for stencil design recommendations. Refer to IPC-7525 for other stencil recommendations.
 - E. Customers should contact their board fabrication site for solder mask tolerances between and around signal pads.

IMPORTANT NOTICE

Texas Instruments Incorporated and its subsidiaries (TI) reserve the right to make corrections, enhancements, improvements and other changes to its semiconductor products and services per JESD46, latest issue, and to discontinue any product or service per JESD48, latest issue. Buyers should obtain the latest relevant information before placing orders and should verify that such information is current and complete. All semiconductor products (also referred to herein as "components") are sold subject to TI's terms and conditions of sale supplied at the time of order acknowledgment.

TI warrants performance of its components to the specifications applicable at the time of sale, in accordance with the warranty in TI's terms and conditions of sale of semiconductor products. Testing and other quality control techniques are used to the extent TI deems necessary to support this warranty. Except where mandated by applicable law, testing of all parameters of each component is not necessarily performed.

TI assumes no liability for applications assistance or the design of Buyers' products. Buyers are responsible for their products and applications using TI components. To minimize the risks associated with Buyers' products and applications, Buyers should provide adequate design and operating safeguards.

TI does not warrant or represent that any license, either express or implied, is granted under any patent right, copyright, mask work right, or other intellectual property right relating to any combination, machine, or process in which TI components or services are used. Information published by TI regarding third-party products or services does not constitute a license to use such products or services or a warranty or endorsement thereof. Use of such information may require a license from a third party under the patents or other intellectual property of the third party, or a license from TI under the patents or other intellectual property of TI.

Reproduction of significant portions of TI information in TI data books or data sheets is permissible only if reproduction is without alteration and is accompanied by all associated warranties, conditions, limitations, and notices. TI is not responsible or liable for such altered documentation. Information of third parties may be subject to additional restrictions.

Resale of TI components or services with statements different from or beyond the parameters stated by TI for that component or service voids all express and any implied warranties for the associated TI component or service and is an unfair and deceptive business practice. TI is not responsible or liable for any such statements.

Buyer acknowledges and agrees that it is solely responsible for compliance with all legal, regulatory and safety-related requirements concerning its products, and any use of TI components in its applications, notwithstanding any applications-related information or support that may be provided by TI. Buyer represents and agrees that it has all the necessary expertise to create and implement safeguards which anticipate dangerous consequences of failures, monitor failures and their consequences, lessen the likelihood of failures that might cause harm and take appropriate remedial actions. Buyer will fully indemnify TI and its representatives against any damages arising out of the use of any TI components in safety-critical applications.

In some cases, TI components may be promoted specifically to facilitate safety-related applications. With such components, TI's goal is to help enable customers to design and create their own end-product solutions that meet applicable functional safety standards and requirements. Nonetheless, such components are subject to these terms.

No TI components are authorized for use in FDA Class III (or similar life-critical medical equipment) unless authorized officers of the parties have executed a special agreement specifically governing such use.

Only those TI components which TI has specifically designated as military grade or "enhanced plastic" are designed and intended for use in military/aerospace applications or environments. Buyer acknowledges and agrees that any military or aerospace use of TI components which have **not** been so designated is solely at the Buyer's risk, and that Buyer is solely responsible for compliance with all legal and regulatory requirements in connection with such use.

TI has specifically designated certain components as meeting ISO/TS16949 requirements, mainly for automotive use. In any case of use of non-designated products, TI will not be responsible for any failure to meet ISO/TS16949.

Products

Audio	www.ti.com/audio
Amplifiers	amplifier.ti.com
Data Converters	dataconverter.ti.com
DLP® Products	www.dlp.com
DSP	dsp.ti.com
Clocks and Timers	www.ti.com/clocks
Interface	interface.ti.com
Logic	logic.ti.com
Power Mgmt	power.ti.com
Microcontrollers	microcontroller.ti.com
RFID	www.ti-rfid.com
OMAP Applications Processors	www.ti.com/omap
Wireless Connectivity	www.ti.com/wirelessconnectivity

Applications

Automotive and Transportation	www.ti.com/automotive
Communications and Telecom	www.ti.com/communications
Computers and Peripherals	www.ti.com/computers
Consumer Electronics	www.ti.com/consumer-apps
Energy and Lighting	www.ti.com/energy
Industrial	www.ti.com/industrial
Medical	www.ti.com/medical
Security	www.ti.com/security
Space, Avionics and Defense	www.ti.com/space-avionics-defense
Video and Imaging	www.ti.com/video

TI E2E Community

e2e.ti.com

Looking for pricing, stock, or lifecycle information?

Click below to explore more details on WIN SOURCE:

 [View TPS2031D](#) on WIN SOURCE

 [Texas Instruments](#) Information

Optimize Your Supply Chain with WIN SOURCE Solutions

-  Global Sourcing Solution
-  Obsolete Management
-  Cost Control Management
-  Shortage Management
-  Alternative Solution
-  Excess Inventory Management