



**THE DATASHEET OF  
TPS22924CZPR**



## TPS22924x 3.6-V, 2-A, 18.3-mΩ On-Resistance Load Switch

### 1 Features

- Integrated Single Load Switch
- Input Voltage: 0.75 V to 3.6 V
- On-Resistance
  - $R_{ON} = 18.3 \text{ m}\Omega$  at  $V_{IN} = 3.6 \text{ V}$
  - $R_{ON} = 19.6 \text{ m}\Omega$  at  $V_{IN} = 1.8 \text{ V}$
  - $R_{ON} = 19.4 \text{ m}\Omega$  at  $V_{IN} = 1.2 \text{ V}$
  - $R_{ON} = 22.7 \text{ m}\Omega$  at  $V_{IN} = 0.75 \text{ V}$
- Small CSP-6 package  
0.9 mm x 1.4 mm, 0.5-mm Pitch
- 2 A Maximum Continuous Switch Current
- Low Shutdown Current
- Low Threshold Control Input
- Controlled Slew Rate to Avoid Inrush Currents
- Quick Output Discharge Transistor
- ESD Performance Tested Per JESD 22
  - 5000-V Human-Body Model (A114-B, Class II)
  - 1000-V Charged-Device Model (C101)

### 2 Applications

- Battery Powered Equipment
- Portable Industrial Equipment
- Portable Medical Equipment
- Portable Media Players
- Point Of Sales Terminal
- GPS Devices
- Digital Cameras
- Notebooks / Tablet PCs / eReaders
- Smartphones

### 3 Description

The TPS22924x is a small, low  $R_{ON}$  load switch with controlled turn on. The device contains a N-channel MOSFET that can operate over an input voltage range of 0.75 V to 3.6 V. An integrated charge pump biases the NMOS switch to achieve a minimum switch ON resistance. The switch is controlled by an on/off input (ON), which is capable of interfacing directly with low-voltage control signals.

A 1250  $\Omega$  on-chip load resistor is added for output quick discharge when the switch is turned off. The rise time of the device is internally controlled to avoid inrush current. The TPS22924B features a rise time of 100  $\mu\text{s}$  at  $V_{IN} = 3.6 \text{ V}$  while the TPS22924C has a rise time of 800  $\mu\text{s}$  at  $V_{IN} = 3.6 \text{ V}$ .

The TPS22924x is available in an ultra-small space-saving 6-pin CSP package and is characterized for operation over the free-air temperature range of  $-40^\circ\text{C}$  to  $85^\circ\text{C}$ .

#### Device Information (1)

PART NUMBER	PACKAGE	BODY SIZE (NOM)
TPS22924B	DSBGA (6)	1.40 mm x 0.90 mm
TPS22924C	DSBGA (6)	1.40 mm x 0.90 mm

(1) For all available packages, see the orderable addendum at the end of the datasheet.

#### Simplified Schematic

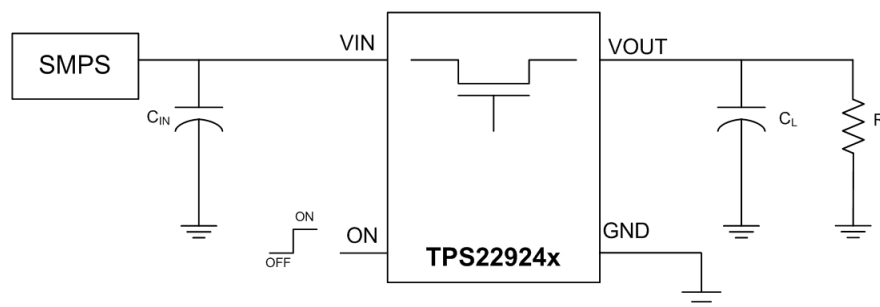

NOTE: SMPS = Switched-mode power supply



## Table of Contents

<b>1 Features</b> .....	<b>1</b>	9.1 Overview .....	14
<b>2 Applications</b> .....	<b>1</b>	9.2 Functional Block Diagram .....	14
<b>3 Description</b> .....	<b>1</b>	9.3 Feature Description .....	14
<b>4 Revision History</b> .....	<b>2</b>	9.4 Device Functional Modes .....	15
<b>5 Device Comparison Table</b> .....	<b>3</b>	<b>10 Application and Implementation</b> .....	<b>16</b>
<b>6 Pin Configuration and Functions</b> .....	<b>3</b>	10.1 Application Information .....	16
<b>7 Specifications</b> .....	<b>4</b>	10.2 Typical Application .....	16
7.1 Absolute Maximum Ratings .....	4	<b>11 Power Supply Recommendations</b> .....	<b>18</b>
7.2 ESD Ratings .....	4	<b>12 Layout</b> .....	<b>18</b>
7.3 Recommended Operating Conditions .....	4	12.1 Layout Guidelines .....	18
7.4 Thermal Information .....	4	12.2 Layout Example .....	18
7.5 Electrical Characteristics .....	5	<b>13 Device and Documentation Support</b> .....	<b>19</b>
7.6 Switching Characteristics, $V_{IN} = 3.6\text{ V}$ .....	5	13.1 Related Links .....	19
7.7 Switching Characteristics, $V_{IN} = 0.9\text{ V}$ .....	5	13.2 Community Resources .....	19
7.8 Typical Characteristics .....	6	13.3 Trademarks .....	19
7.9 AC Characteristics (TPS22924B) .....	7	13.4 Electrostatic Discharge Caution .....	19
7.10 AC Characteristics (TPS22924C) .....	10	13.5 Glossary .....	19
<b>8 Parameter Measurement Information</b> .....	<b>13</b>	<b>14 Mechanical, Packaging, and Orderable Information</b> .....	<b>19</b>
<b>9 Detailed Description</b> .....	<b>14</b>		

## 4 Revision History

NOTE: Page numbers for previous revisions may differ from page numbers in the current version.

Changes from Revision D (August 2014) to Revision E	Page
• Added device TPS22924C .....	1
• Deleted <i>Features</i> : $r_{ON} = 18.5\text{ m}\Omega$ at $V_{IN} = 2.5\text{ V}$ .....	1
• Deleted <i>Features</i> : $r_{ON} = 20.3\text{ m}\Omega$ at $V_{IN} = 1.0\text{ V}$ .....	1
• Added text to the <i>Description</i> "while the TPS22924C has a rise time of $800\text{ }\mu\text{s}$ at $V_{IN} = 3.6\text{ V}$ . "	1
• Added: TPS22924CZP and TPS22924CZPRB information to <i>Device Comparison Table</i> .....	3
• Added "Storage temperature" to the <i>Absolute Maximum Ratings</i> <sup>(1)</sup> table .....	4
• Changed <i>Handling Ratings</i> to <i>ESD Ratings</i> .....	4
• Added section <i>AC Characteristics (TPS22924C)</i> .....	10
• Changed the <i>Application Curve</i> section .....	17

Changes from Revision C (July 2014) to Revision D	Page
• Added <i>Pin Configuration and Functions</i> section, <i>Overview</i> section, <i>Feature Description</i> section, <i>Power Supply Recommendations</i> section .....	1

Changes from Revision B (June 2013) to Revision C	Page
• Added Device Information table. ....	1
• Added <i>Handling Ratings</i> table. ....	4
• Added Detailed Description section. ....	14

## 5 Device Comparison Table

T <sub>A</sub>	PACKAGE <sup>(1)</sup>	ORDERABLE PART NUMBER	TOP-SIDE MARKING <sup>(2)</sup>	BACKSIDE COATING <sup>(3)</sup>	RISE TIME AT VIN = 3.3V (TYP.)
–40°C to 85°C	YZ (0.4mm height)	TPS22924BYZR	___ 5N _	No	96µs
–40°C to 85°C	YZP (0.5mm height)	TPS22924BYZPRB	___ 5N _	Yes	96µs
–40°C to 85°C	YZZ (0.35mm height)	TPS22924BYZZR	___ 7A _	No	96µs
–40°C to 85°C	YZP (0.5mm height)	TPS22924CZPZR	___ 5L _	No	800µs
–40°C to 85°C	YZP (0.4mm height)	TPS22924CZPRB	___ 5L _	Yes	800µs

- (1) Package drawings, thermal data, and symbolization are available at [www.ti.com/packaging](http://www.ti.com/packaging).
- (2) The actual top-side marking has three preceding characters to denote year, month, and sequence code, and one following character to designate the wafer fab/assembly site. Pin 1 identifier indicates solder-bump composition (1 = SnPb, • = Pb-free).
- (3) CSP (DSBGA) devices manufactured with backside coating have an increased resistance to cracking due to the increased physical strength of the package. Devices with backside coating are highly encouraged for new designs.

## 6 Pin Configuration and Functions

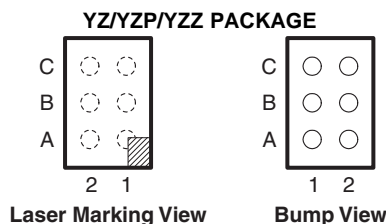

**Table 1. Pin Assignments (YZ/YZP/YZZ Package)**

C	GND	ON
B	VOUT	VIN
A	VOUT	VIN
	1	2

### Pin Functions

NO.	NAME	DESCRIPTION
C1	GND	Ground
C2	ON	Switch control input, active high. Do not leave floating
A1, B1	VOUT	Switch output
A2, B2	VIN	Switch input, bypass this input with a ceramic capacitor to ground

## 7 Specifications

### 7.1 Absolute Maximum Ratings <sup>(1)</sup>

		MIN	MAX	UNIT
V <sub>IN</sub>	Input voltage range	-0.3	4	V
V <sub>OUT</sub>	Output voltage range		V <sub>IN</sub> + 0.3	V
V <sub>ON</sub>	Input voltage range	-0.3	4	V
I <sub>MAX</sub>	Maximum continuous switch current, T <sub>A</sub> = -40°C to 85°C		2	A
I <sub>PLS</sub>	Maximum pulsed switch current, 100-μs pulse, 2% duty cycle, T <sub>A</sub> = -40°C to 85°C		4	A
T <sub>A</sub>	Operating free-air temperature range	-40	85	°C
T <sub>stg</sub>	Storage temperature	-65	150	°C

(1) Stresses beyond those listed under Absolute Maximum Ratings may cause permanent damage to the device. These are stress ratings only, and functional operation of the device at these or any other conditions beyond those indicated under [Recommended Operating Conditions](#) is not implied. Exposure to absolute-maximum-rated conditions for extended periods may affect device reliability.

### 7.2 ESD Ratings

			VALUE	UNIT
V <sub>(ESD)</sub>	Electrostatic discharge	Human body model (HBM), per ANSI/ESDA/JEDEC JS-001, all pins <sup>(1)</sup>	±5000	V
		Charged device model (CDM), per JEDEC specification JESD22-C101, all pins <sup>(2)</sup>	±1000	

(1) JEDEC document JEP155 states that 500-V HBM allows safe manufacturing with a standard ESD control process.

(2) JEDEC document JEP157 states that 250-V CDM allows safe manufacturing with a standard ESD control process.

### 7.3 Recommended Operating Conditions

			MIN	MAX	UNIT
V <sub>IN</sub>	Input voltage		0.75	3.6	V
V <sub>OUT</sub>	Output voltage			V <sub>IN</sub>	V
V <sub>IH</sub>	High-level input voltage, ON	V <sub>IN</sub> = 2.5 V to 3.6 V	1.2	3.6	V
		V <sub>IN</sub> = 0.75 V to 2.5 V	0.9	3.6	
V <sub>IL</sub>	Low-level input voltage, ON	V <sub>IN</sub> = 2.5 V to 3.6 V		0.6	V
		V <sub>IN</sub> = 0.75 V to 2.49 V		0.4	
C <sub>IN</sub>	Input capacitance		1 <sup>(1)</sup>		μF

(1) See the [Input Capacitor](#) section in Application Information.

### 7.4 Thermal Information

THERMAL METRIC <sup>(1)</sup>		TPS22924x	UNIT
		YZ/YZZ/YZP	
		6 PINS	
R <sub>θJA</sub>	Junction-to-ambient thermal resistance	123	°C/W
R <sub>θJC(top)</sub>	Junction-to-case (top) thermal resistance	17.6	
R <sub>θJB</sub>	Junction-to-board thermal resistance	22.8	
Ψ <sub>JT</sub>	Junction-to-top characterization parameter	5.7	
Ψ <sub>JB</sub>	Junction-to-board characterization parameter	22.6	
R <sub>θJC(bot)</sub>	Junction-to-case (bottom) thermal resistance	N/A	

(1) For more information about traditional and new thermal metrics, see the [IC Package Thermal Metrics](#) application report, [SPRA953](#).

## 7.5 Electrical Characteristics

 $V_{IN} = 0.75\text{ V to }3.6\text{ V}$  (unless otherwise noted)

PARAMETER		TEST CONDITIONS	$T_A$	MIN	TYP (1)	MAX	UNIT
$I_{IN}$	Quiescent current	$I_{OUT} = 0, V_{IN} = V_{ON}$	Full		75	160	$\mu\text{A}$
					42	70	
					50	350	
					95	200	
					65	110	
					35	70	
$I_{IN(LEAK)}$	OFF-state supply current	$V_{ON} = \text{GND}, \text{OUT} = 0\text{V}$	Full		3.5	$\mu\text{A}$	
$R_{ON}$	ON-state resistance	$I_{OUT} = -200\text{ mA}$	25°C	Full	18.3	19.7	$\text{m}\Omega$
					26.0		
			25°C	Full	18.5	19.5	
					25.8		
			25°C	Full	19.6	21.8	
					27.4		
			25°C	Full	19.4	21.8	
					28.0		
25°C	Full	20.3	21.2				
		28.6					
25°C	Full	22.7	25.3				
		34.8					
$R_{PD}$	Output pulldown resistance (2)	$V_{IN} = 3.3\text{ V}, V_{ON} = 0, I_{OUT} = 3\text{ mA}$	25°C		1250	1500	$\Omega$
$I_{ON}$	ON-state input leakage current	$V_{ON} = 0.9\text{ V to }3.6\text{ V or GND}$	Full		0.1	$\mu\text{A}$	

(1) Typical values are at  $V_{IN} = 3.3\text{ V}$  and  $T_A = 25^\circ\text{C}$ .

(2) See [Output Pulldown](#) in the Application and Implementation section.

## 7.6 Switching Characteristics, $V_{IN} = 3.6\text{ V}$

 $V_{IN} = 3.6\text{ V}, T_A = 25^\circ\text{C}$  (unless otherwise noted)

PARAMETER		TEST CONDITIONS	TPS22924B (TYP)	TPS22924C (TYP)	UNIT
$t_{ON}$	Turn-ON time	$R_L = 10\ \Omega, C_L = 0.1\ \mu\text{F}, V_{IN} = 3.6\text{V}$	111	800	$\mu\text{s}$
$t_{OFF}$	Turn-OFF time	$R_L = 10\ \Omega, C_L = 0.1\ \mu\text{F}, V_{IN} = 3.6\text{V}$	3	3	$\mu\text{s}$
$t_r$	$V_{OUT}$ rise time	$R_L = 10\ \Omega, C_L = 0.1\ \mu\text{F}, V_{IN} = 3.6\text{V}$	96	800	$\mu\text{s}$
$t_f$	$V_{OUT}$ fall time	$R_L = 10\ \Omega, C_L = 0.1\ \mu\text{F}, V_{IN} = 3.6\text{V}$	2.5	2.5	$\mu\text{s}$

## 7.7 Switching Characteristics, $V_{IN} = 0.9\text{ V}$

 $V_{IN} = 0.9\text{ V}, T_A = 25^\circ\text{C}$  (unless otherwise noted)

PARAMETER		TEST CONDITIONS	TPS22924B (TYP)	TPS22924C (TYP)	UNIT
$t_{ON}$	Turn-ON time	$R_L = 10\ \Omega, C_L = 0.1\ \mu\text{F}, V_{IN} = 0.9\text{V}$	160	865	$\mu\text{s}$
$t_{OFF}$	Turn-OFF time	$R_L = 10\ \Omega, C_L = 0.1\ \mu\text{F}, V_{IN} = 0.9\text{V}$	20	20	$\mu\text{s}$
$t_r$	$V_{OUT}$ rise time	$R_L = 10\ \Omega, C_L = 0.1\ \mu\text{F}, V_{IN} = 0.9\text{V}$	81	500	$\mu\text{s}$
$t_f$	$V_{OUT}$ fall time	$R_L = 10\ \Omega, C_L = 0.1\ \mu\text{F}, V_{IN} = 0.9\text{V}$	5	5	$\mu\text{s}$

## 7.8 Typical Characteristics

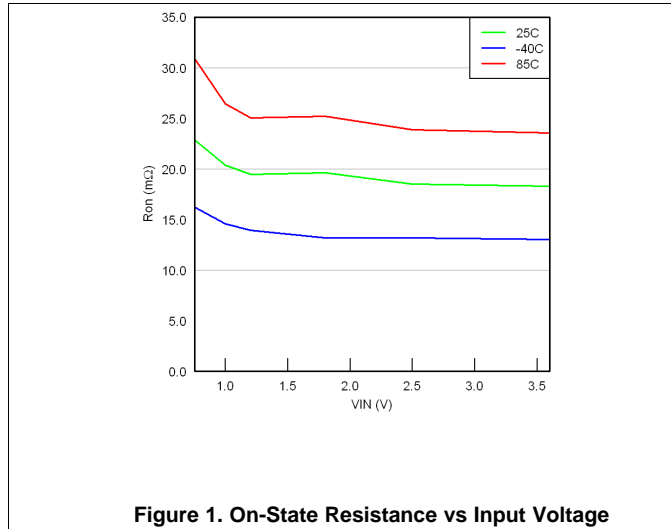

Figure 1. On-State Resistance vs Input Voltage

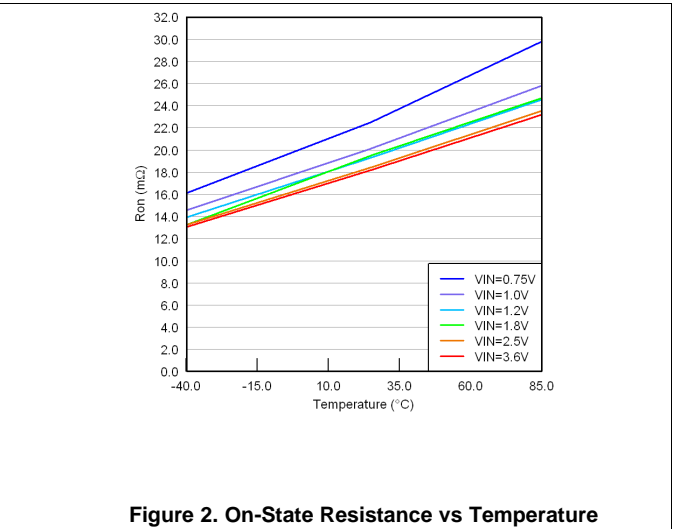

Figure 2. On-State Resistance vs Temperature

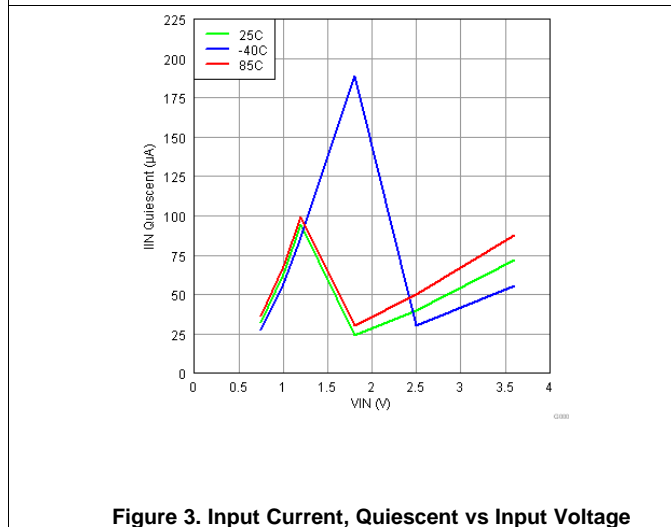

Figure 3. Input Current, Quiescent vs Input Voltage

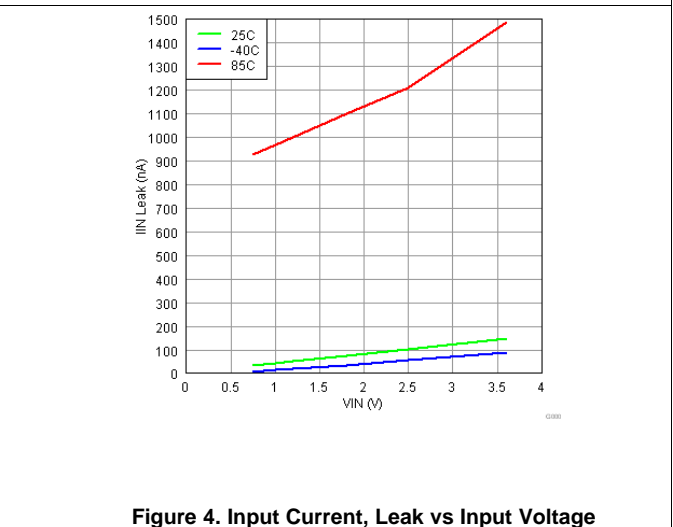

Figure 4. Input Current, Leak vs Input Voltage

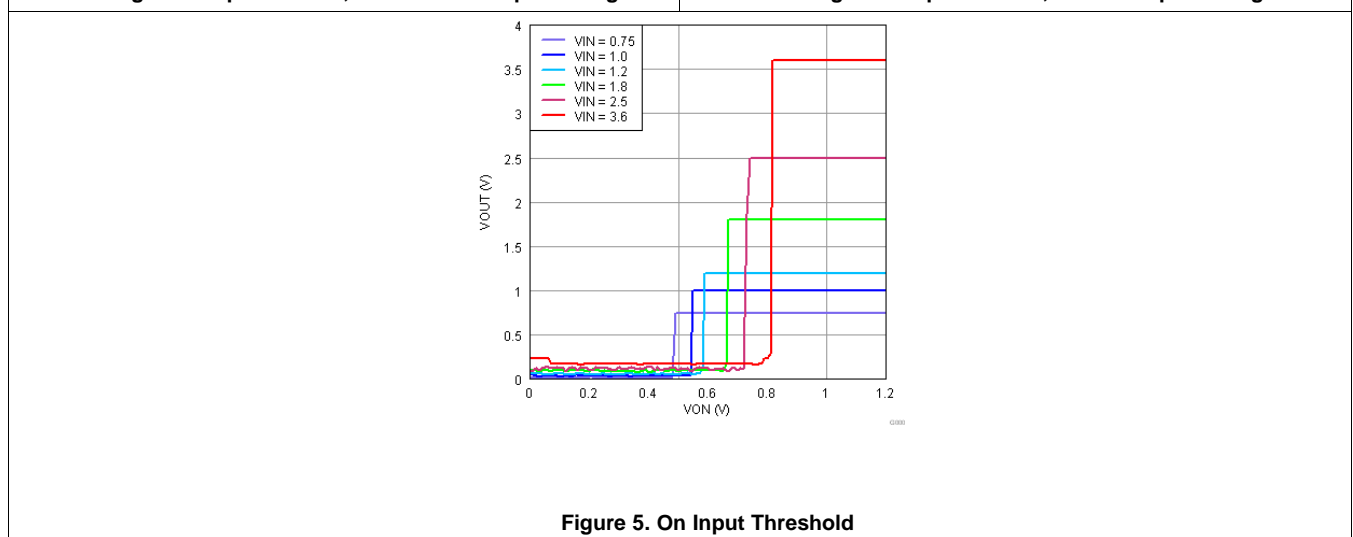
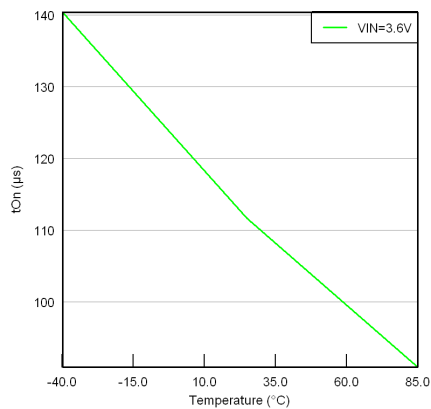

Figure 5. On Input Threshold

### 7.9 AC Characteristics (TPS22924B)



$V_{IN} = 3.6\text{ V}$ ,  $C_L = 0.1\ \mu\text{F}$ ,  $R_L = 10\ \Omega$

Figure 6. Turn-On Time vs Temperature

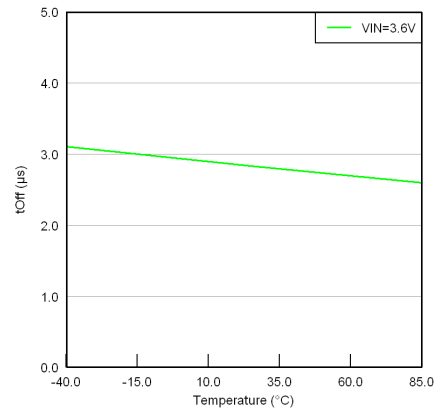

$V_{IN} = 3.6\text{ V}$ ,  $C_L = 0.1\ \mu\text{F}$ ,  $R_L = 10\ \Omega$

Figure 7. Turn-Off Time vs Temperature

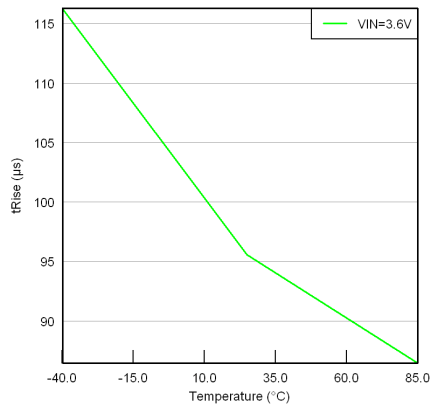

$V_{IN} = 3.6\text{ V}$ ,  $C_L = 0.1\ \mu\text{F}$ ,  $R_L = 10\ \Omega$

Figure 8. Rise Time vs Temperature

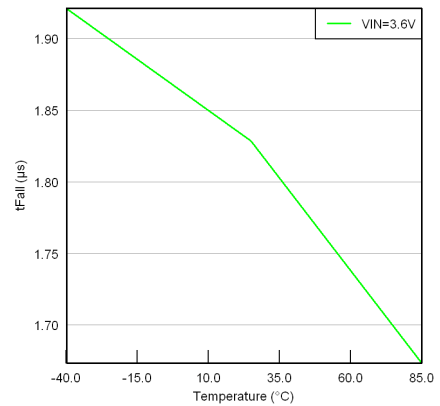

$V_{IN} = 3.6\text{ V}$ ,  $C_L = 0.1\ \mu\text{F}$ ,  $R_L = 10\ \Omega$

Figure 9. Fall Time vs Temperature

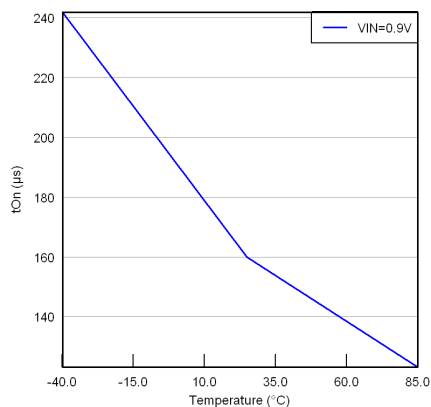

$V_{IN} = 0.9\text{ V}$ ,  $C_L = 0.1\ \mu\text{F}$ ,  $R_L = 10\ \Omega$

Figure 10. Turn-On Time vs Temperature

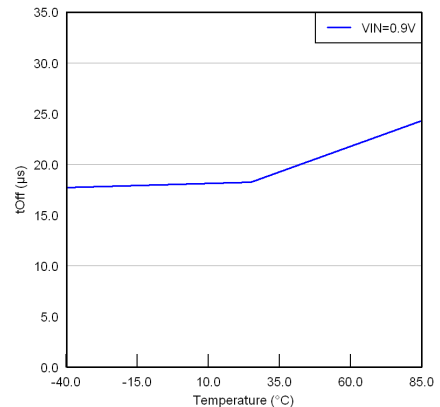

$V_{IN} = 0.9\text{ V}$ ,  $C_L = 0.1\ \mu\text{F}$ ,  $R_L = 10\ \Omega$

Figure 11. Turn-Off Time vs Temperature

AC Characteristics (TPS22924B) (continued)

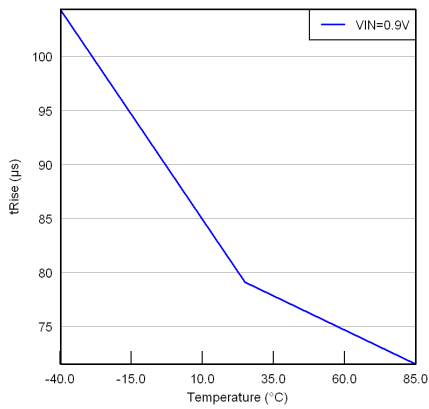

$V_{IN} = 0.9\text{ V}$ ,  $C_L = 0.1\ \mu\text{F}$ ,  $R_L = 10\ \Omega$

Figure 12. Rise Time vs Temperature

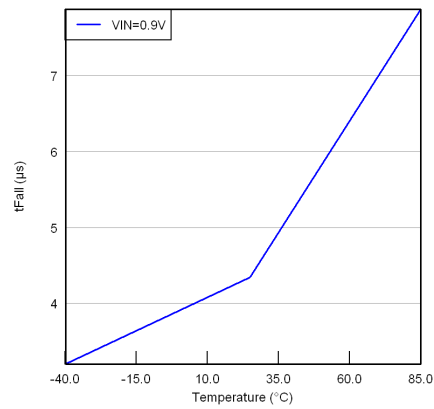

$V_{IN} = 0.9\text{ V}$ ,  $C_L = 0.1\ \mu\text{F}$ ,  $R_L = 10\ \Omega$

Figure 13. Fall Time vs Temperature

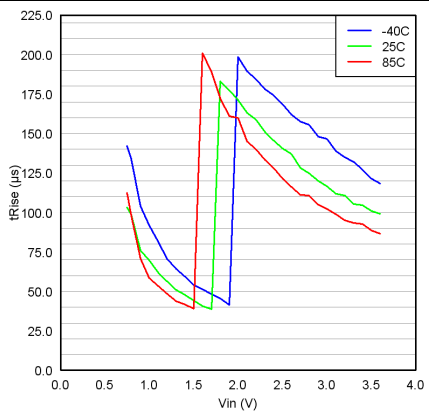

$V_{ON} = 1.8\text{ V}$ ,  $C_L = 0.1\ \mu\text{F}$ ,  $R_L = 10\ \Omega$

Figure 14. Rise Time vs Input Voltage

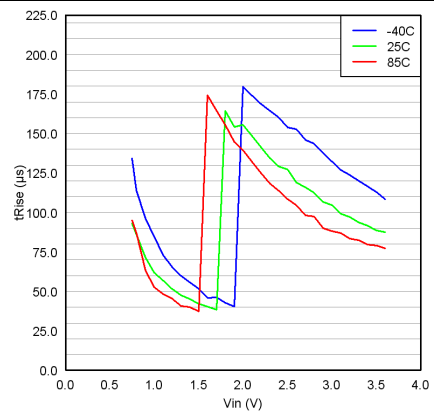

$V_{ON} = 1.8\text{ V}$ ,  $C_L = 20\ \mu\text{F}$ ,  $R_L = 10\ \Omega$

Figure 15. Rise Time vs Input Voltage

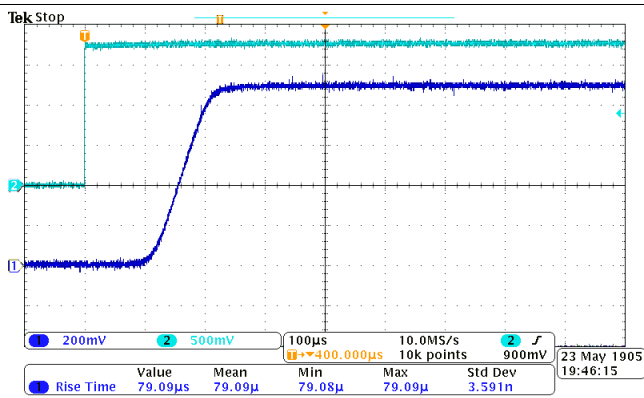

Figure 16. Turn-On Response

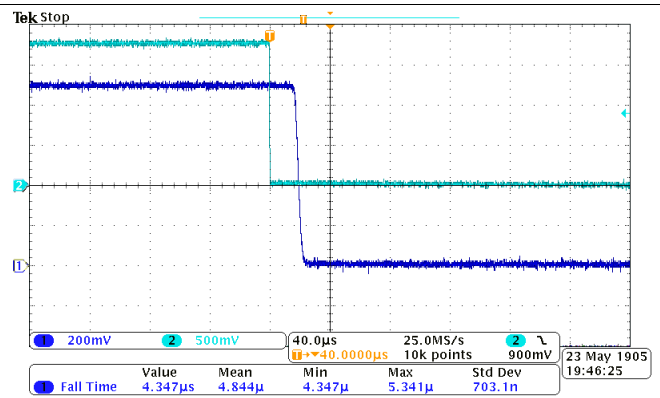

Figure 17. Turn-Off Response

AC Characteristics (TPS22924B) (continued)

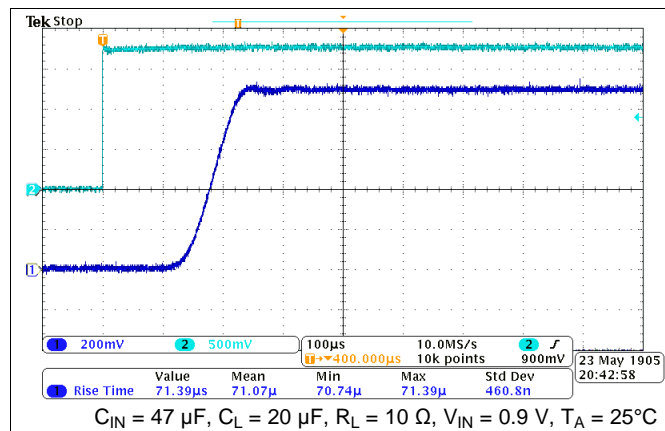

Figure 18. Turn-On Response

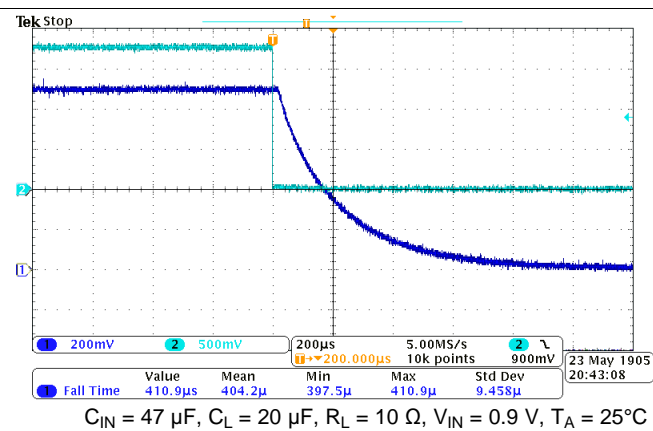

Figure 19. Turn-Off Response

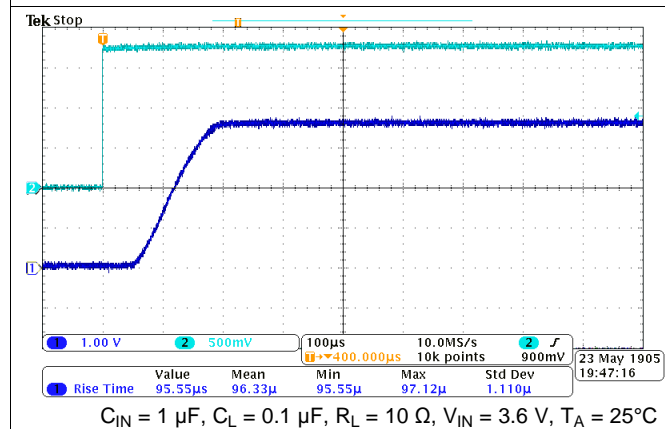

Figure 20. Turn-On Response

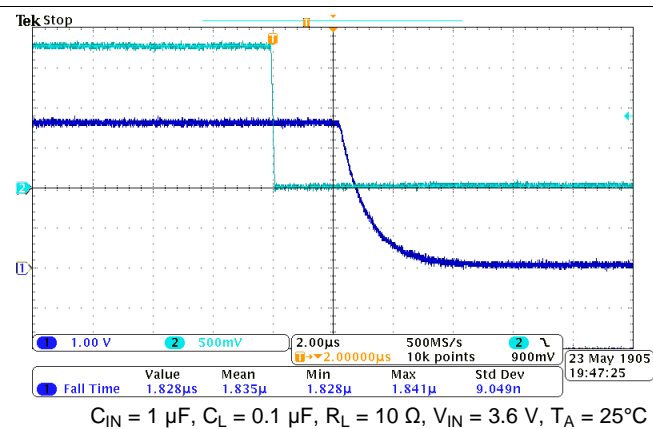

Figure 21. Turn-Off Response

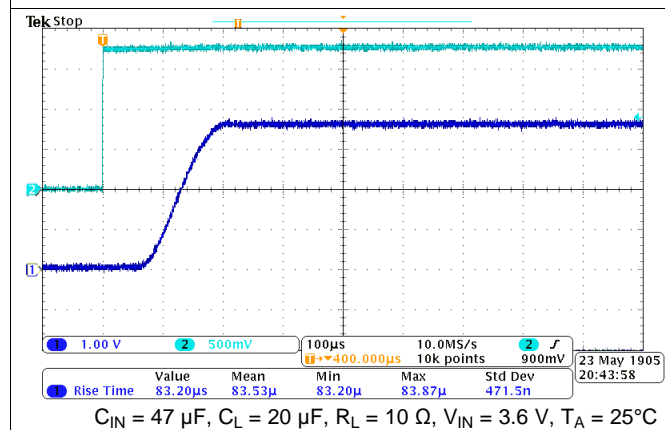

Figure 22. Turn-On Response

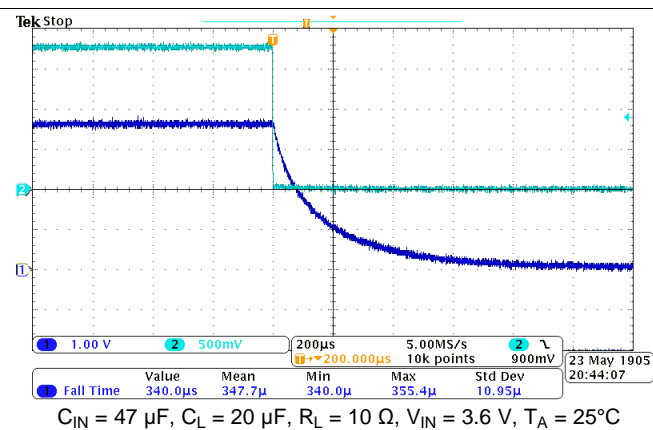
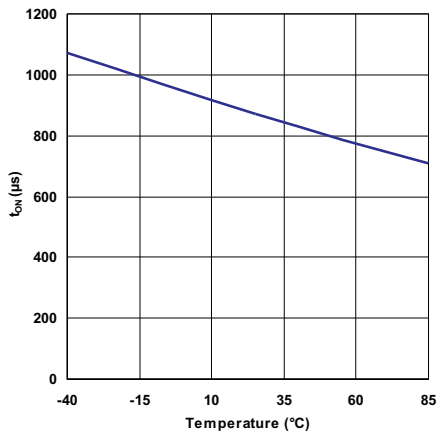

Figure 23. Turn-Off Response

### 7.10 AC Characteristics (TPS22924C)



V<sub>IN</sub> = 3.6 V, C<sub>L</sub> = 0.1 µF, R<sub>L</sub> = 10 Ω

Figure 24. Turn-On Time vs Temperature

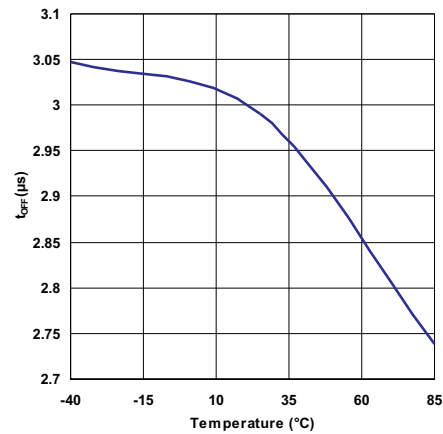

V<sub>IN</sub> = 3.6 V, C<sub>L</sub> = 0.1 µF, R<sub>L</sub> = 10 Ω

Figure 25. Turn-Off Time vs Temperature

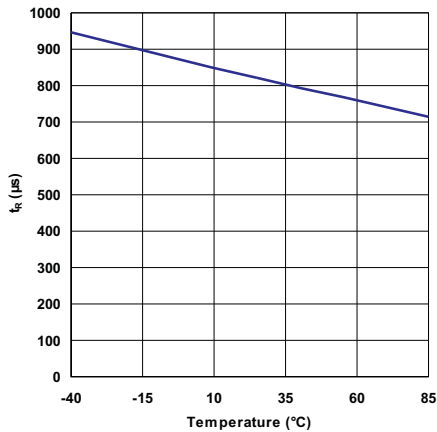

V<sub>IN</sub> = 3.6 V, C<sub>L</sub> = 0.1 µF, R<sub>L</sub> = 10 Ω

Figure 26. Rise Time vs Temperature

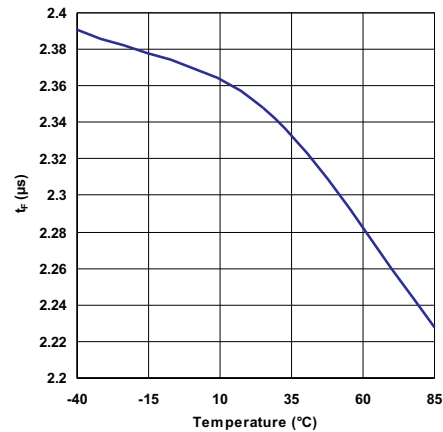

V<sub>IN</sub> = 3.6 V, C<sub>L</sub> = 0.1 µF, R<sub>L</sub> = 10 Ω

Figure 27. Fall Time vs Temperature

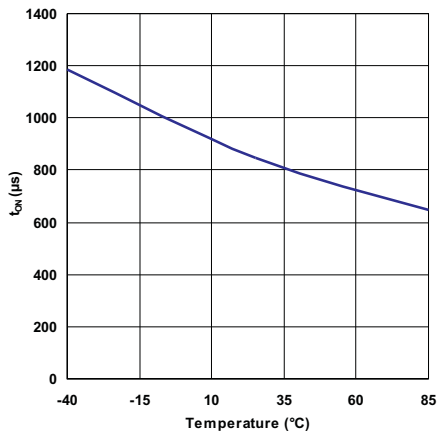

V<sub>IN</sub> = 0.9 V, C<sub>L</sub> = 0.1 µF, R<sub>L</sub> = 10 Ω

Figure 28. Turn-On Time vs Temperature

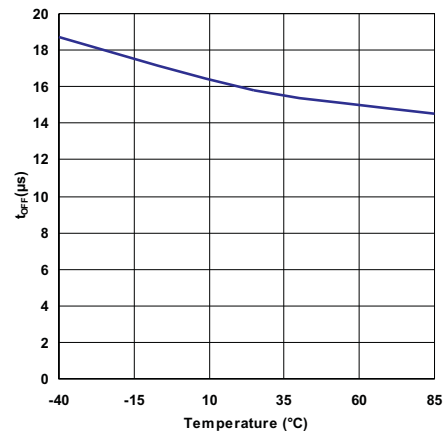

V<sub>IN</sub> = 0.9 V, C<sub>L</sub> = 0.1 µF, R<sub>L</sub> = 10 Ω

Figure 29. Turn-Off Time vs Temperature

AC Characteristics (TPS22924C) (continued)

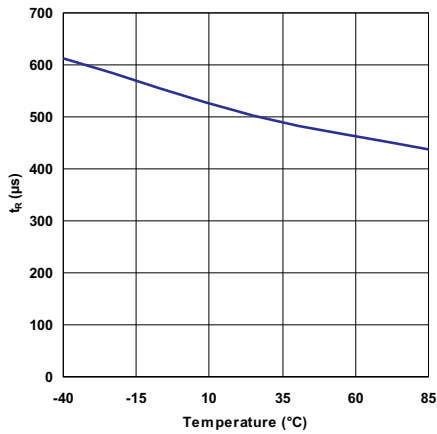

$V_{IN} = 0.9\text{ V}$ ,  $C_L = 0.1\ \mu\text{F}$ ,  $R_L = 10\ \Omega$

Figure 30. Rise Time vs Temperature

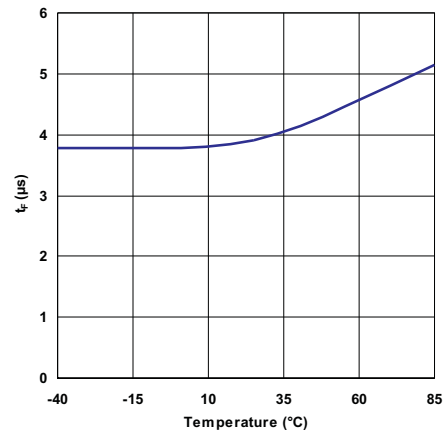

$V_{IN} = 0.9\text{ V}$ ,  $C_L = 0.1\ \mu\text{F}$ ,  $R_L = 10\ \Omega$

Figure 31. Fall Time vs Temperature

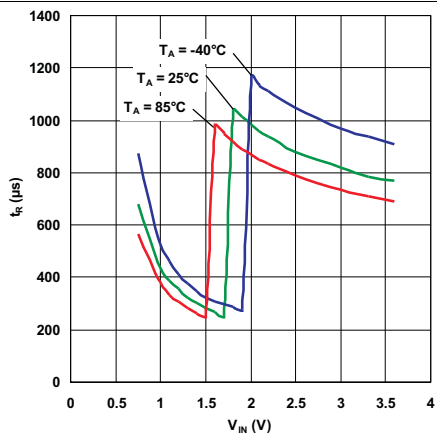

$V_{ON} = 1.8\text{ V}$ ,  $C_L = 0.1\ \mu\text{F}$ ,  $R_L = 10\ \Omega$

Figure 32. Rise Time vs Input Voltage

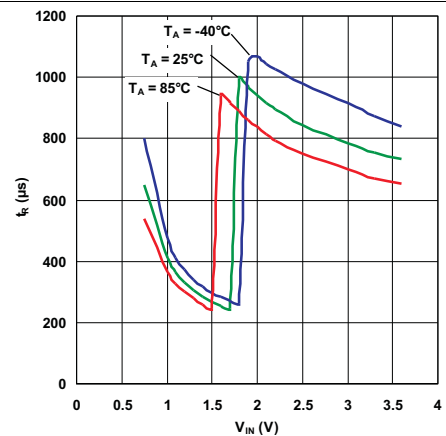

$V_{ON} = 1.8\text{ V}$ ,  $C_L = 20\ \mu\text{F}$ ,  $R_L = 10\ \Omega$

Figure 33. Rise Time vs Input Voltage

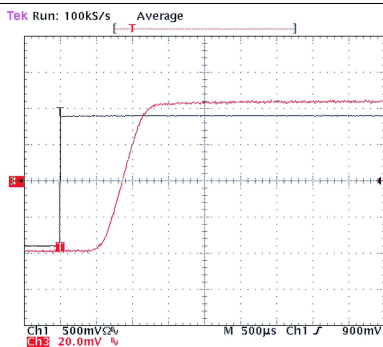

$C_{IN} = 1\ \mu\text{F}$ ,  $C_L = 0.1\ \mu\text{F}$ ,  $R_L = 10\ \Omega$ ,  $V_{IN} = 0.9\text{ V}$ ,  $T_A = 25^\circ\text{C}$

Figure 34. Turn-On Response

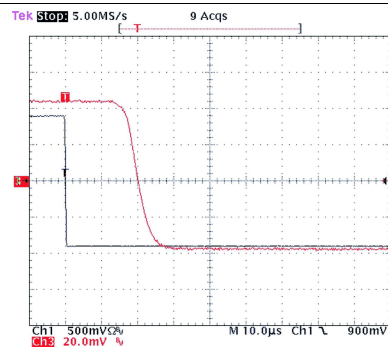

$C_{IN} = 1\ \mu\text{F}$ ,  $C_L = 0.1\ \mu\text{F}$ ,  $R_L = 10\ \Omega$ ,  $V_{IN} = 0.9\text{ V}$ ,  $T_A = 25^\circ\text{C}$

Figure 35. Turn-Off Response

AC Characteristics (TPS22924C) (continued)

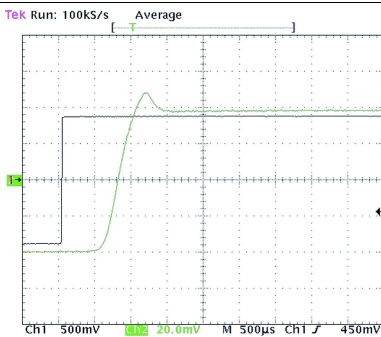

$C_{IN} = 47 \mu\text{F}$ ,  $C_L = 20 \mu\text{F}$ ,  $R_L = 10 \Omega$ ,  $V_{IN} = 0.9 \text{ V}$ ,  $T_A = 25^\circ\text{C}$

Figure 36. Turn-On Response

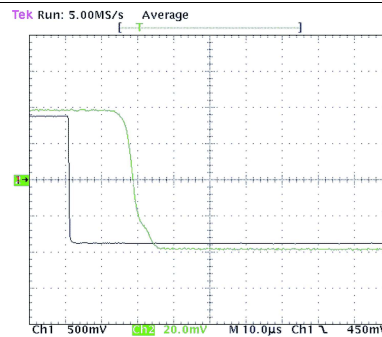

$C_{IN} = 47 \mu\text{F}$ ,  $C_L = 20 \mu\text{F}$ ,  $R_L = 10 \Omega$ ,  $V_{IN} = 0.9 \text{ V}$ ,  $T_A = 25^\circ\text{C}$

Figure 37. Turn-Off Response

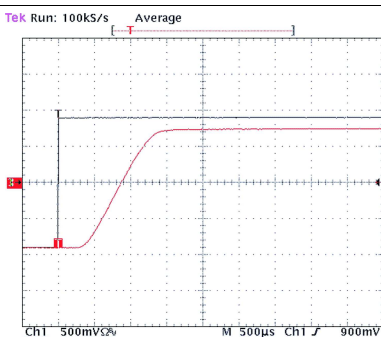

$C_{IN} = 1 \mu\text{F}$ ,  $C_L = 0.1 \mu\text{F}$ ,  $R_L = 10 \Omega$ ,  $V_{IN} = 3.6 \text{ V}$ ,  $T_A = 25^\circ\text{C}$

Figure 38. Turn-On Response

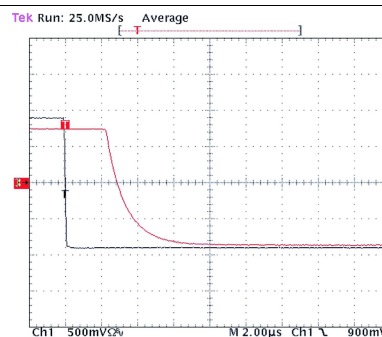

$C_{IN} = 1 \mu\text{F}$ ,  $C_L = 0.1 \mu\text{F}$ ,  $R_L = 10 \Omega$ ,  $V_{IN} = 3.6 \text{ V}$ ,  $T_A = 25^\circ\text{C}$

Figure 39. Turn-Off Response

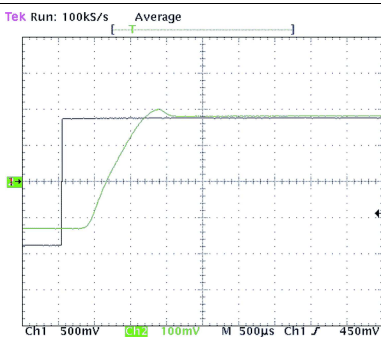

$C_{IN} = 47 \mu\text{F}$ ,  $C_L = 20 \mu\text{F}$ ,  $R_L = 10 \Omega$ ,  $V_{IN} = 3.6 \text{ V}$ ,  $T_A = 25^\circ\text{C}$

Figure 40. Turn-On Response

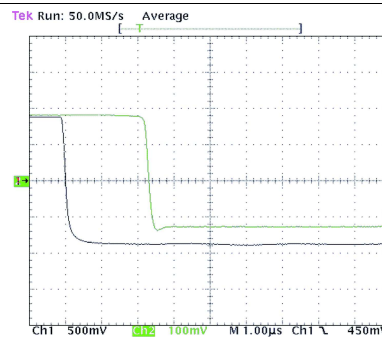

$C_{IN} = 47 \mu\text{F}$ ,  $C_L = 20 \mu\text{F}$ ,  $R_L = 10 \Omega$ ,  $V_{IN} = 3.6 \text{ V}$ ,  $T_A = 25^\circ\text{C}$

Figure 41. Turn-Off Response

## 8 Parameter Measurement Information

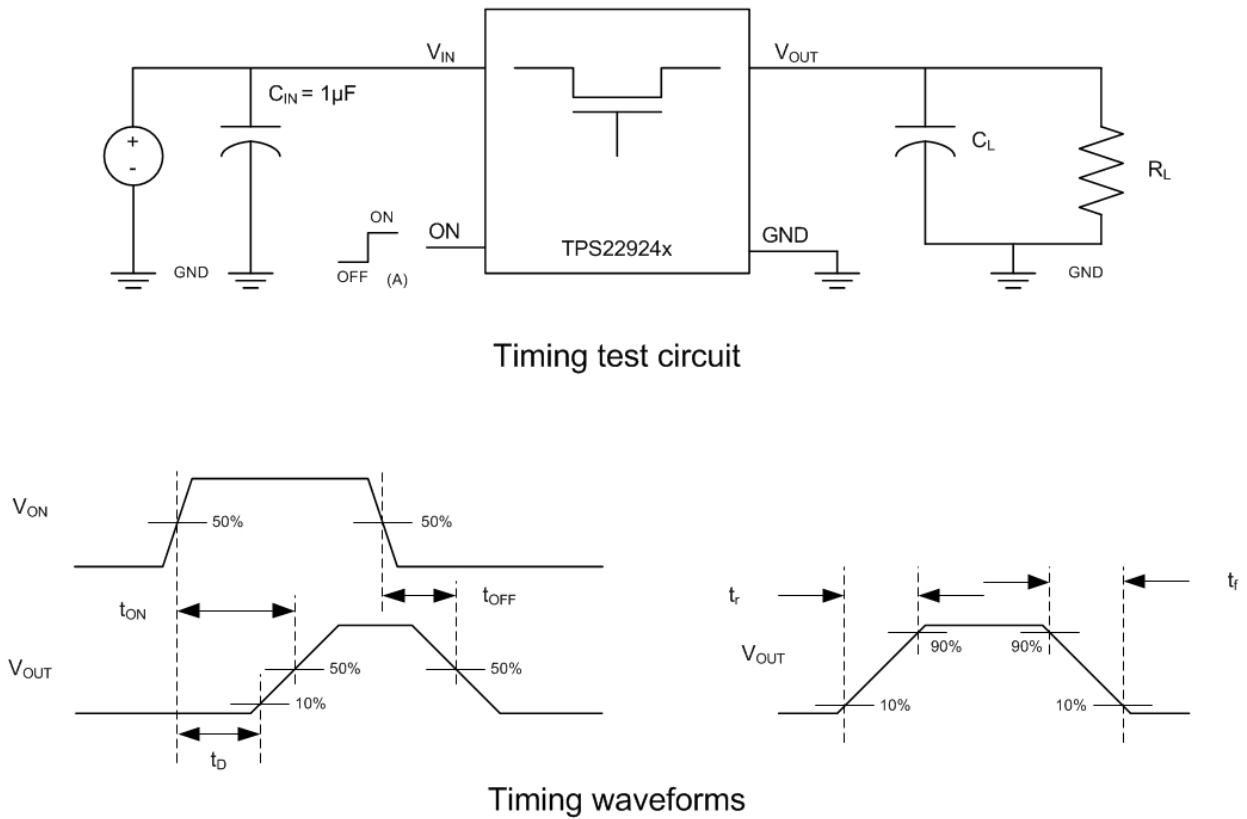

(A) Rise and fall times of the control signal is 100ns.

**Figure 42. Test Circuit and  $t_{ON}/t_{OFF}$  Waveforms**

## 9 Detailed Description

### 9.1 Overview

The TPS22924x is a single channel, 2-A load switch in a small, space-saving CSP-6 package. This device implements a low resistance N-channel MOSFET with a controlled rise time for applications that need to limit the inrush current.

This device is also designed to have very low leakage current during off state. This prevents downstream circuits from pulling high standby current from the supply. Integrated control logic, driver, power supply, and output discharge FET eliminates the need for additional external components, which reduces solution size and bill of materials (BOM) count.

### 9.2 Functional Block Diagram

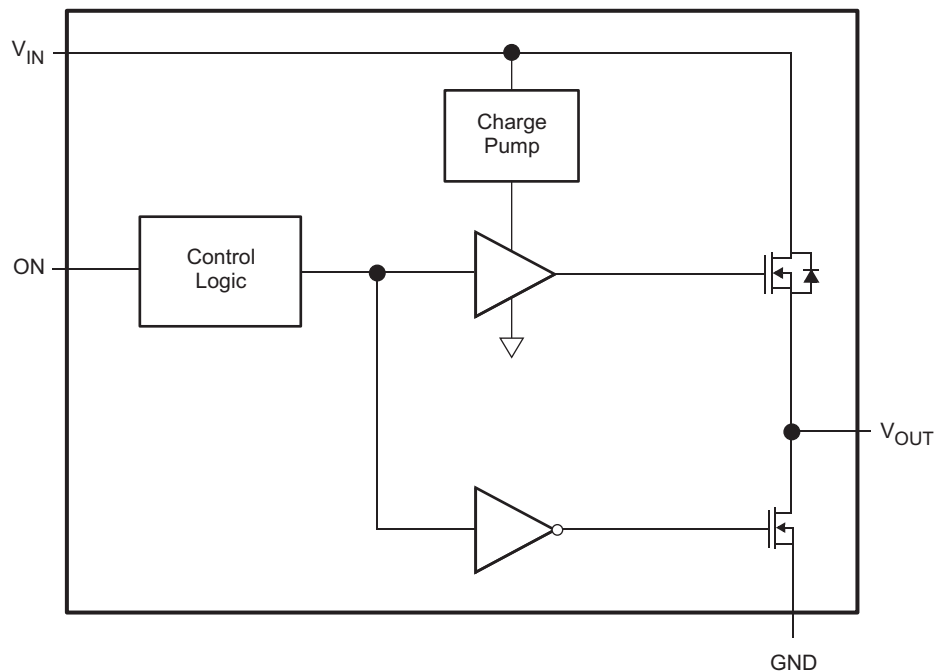

### 9.3 Feature Description

#### 9.3.1 ON/OFF Control

The ON pin controls the state of the switch. Asserting ON high enables the switch. ON is active high and has a low threshold, making it capable of interfacing with low-voltage signals. The ON pin is compatible with standard GPIO logic threshold. It can be used with any microcontroller with 1.2-V, 1.8-V, 2.5-V or 3.3-V GPIOs.

#### 9.3.2 Output Capacitor

Due to the integral body diode in the NMOS switch, a  $C_{IN}$  greater than  $C_L$  is highly recommended. A  $C_L$  greater than  $C_{IN}$  can cause  $V_{OUT}$  to exceed  $V_{IN}$  when the system supply is removed. This could result in current flow through the body diode from  $V_{OUT}$  to  $V_{IN}$ . A  $C_{IN}$  to  $C_L$  ratio of 10 to 1 is recommended for minimizing  $V_{IN}$  dip caused by inrush currents during startup.

#### 9.3.3 Output Pulldown

The output pulldown is active when the user is turning off the main pass FET. The pulldown discharges the output rail to approximately 10% of the rail, then the output pulldown is automatically disconnected to optimize the shutdown current.

## 9.4 Device Functional Modes

ON (CONTROL SIGNAL)	VIN to VOUT	VOUT to GND <sup>(1)</sup>
L	OFF	ON
H	ON	OFF

(1) See application section [Output Pulldown](#).

## 10 Application and Implementation

### NOTE

Information in the following applications sections is not part of the TI component specification, and TI does not warrant its accuracy or completeness. TI's customers are responsible for determining suitability of components for their purposes. Customers should validate and test their design implementation to confirm system functionality.

### 10.1 Application Information

#### 10.1.1 VIN to VOUT Voltage Drop

The VIN to VOUT voltage drop in the device is determined by the  $R_{ON}$  of the device and the load current. The  $R_{ON}$  of the device depends upon the VIN condition of the device. Refer to the  $R_{ON}$  specification of the device in the Electrical Characteristics table of this datasheet. Once the  $R_{ON}$  of the device is determined based upon the VIN conditions, use [Equation 1](#) to calculate the VIN to VOUT voltage drop:

$$\Delta V = I_{LOAD} \times R_{ON}$$

where

- $\Delta V$  = Voltage drop from VIN to VOUT
- $I_{LOAD}$  = Load current
- $R_{ON}$  = On-resistance of the device for a specific  $V_{IN}$
- An appropriate  $I_{LOAD}$  must be chosen such that the  $I_{MAX}$  specification of the device is not violated. (1)

#### 10.1.2 Input Capacitor

To limit the voltage drop on the input supply caused by transient inrush currents, when the switch turns on into a discharged load capacitor or short-circuit, a capacitor needs to be placed between VIN and GND. A 1- $\mu$ F ceramic capacitor,  $C_{IN}$ , placed close to the pins is usually sufficient. Higher values of  $C_{IN}$  can be used to further reduce the voltage drop.

#### 10.1.3 Output Capacitor

A  $C_{IN}$  to  $C_L$  ratio of 10 to 1 is recommended for minimizing  $V_{IN}$  dip caused by inrush currents during startup.

### 10.2 Typical Application

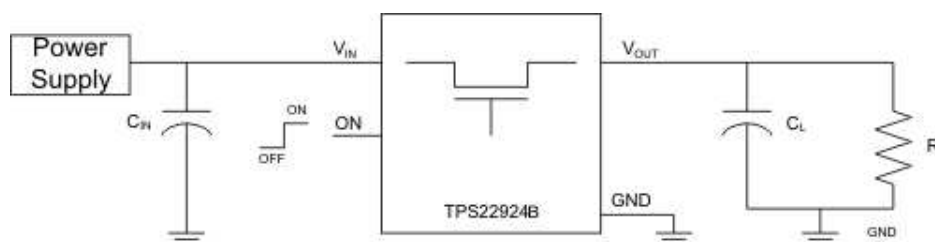

**Figure 43. Typical Application**

#### 10.2.1 Design Requirements

DESIGN PARAMETER	EXAMPLE VALUE
$V_{IN}$	3.6 V
$C_L$	1 $\mu$ F
Maximum Acceptable Inrush Current	40 mA

## 10.2.2 Detailed Design Procedure

### 10.2.2.1 Managing Inrush Current

When the switch is enabled, the output capacitors must be charged up from 0-V to  $V_{IN}$ . This charge arrives in the form of inrush current. Inrush current can be calculated using the following equation:

$$\text{Inrush Current} = C \times \frac{dv}{dt}$$

where

- C = Output capacitance
  - $\frac{dv}{dt}$  = Output slew rate
- (2)

The TPS22924B offers a very slow controlled rise time for minimizing inrush current. This device can be selected based upon the maximum acceptable slew rate which can be calculated using the design requirements and the inrush current equation. An output capacitance of 1.0  $\mu\text{F}$  will be used since the amount of inrush increases with output capacitance:

$$40 \text{ mA} = 1.0 \mu\text{F} \times \frac{dv}{dt}$$

(3)

$$\frac{dv}{dt} = 40 \text{ V/ms}$$

(4)

To ensure an inrush current of less than 40 mA, a device with a slew rate less than 40 V/ms must be used.

The TPS22924B has a typical rise time of 96  $\mu\text{s}$  at 3.6 V. This results in a slew rate of 37.5 V/ms which meets the above design requirements. For an even lower inrush current requirement, the TPS22924C can be used. The slower rise time of 800  $\mu\text{s}$  at 3.6V results in a slew rate of 4.5 V/ms, well below the design requirements.

### 10.2.3 Application Curve

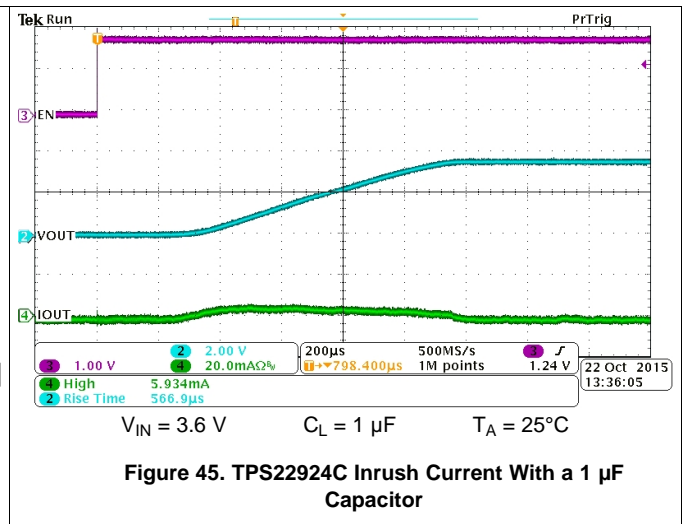
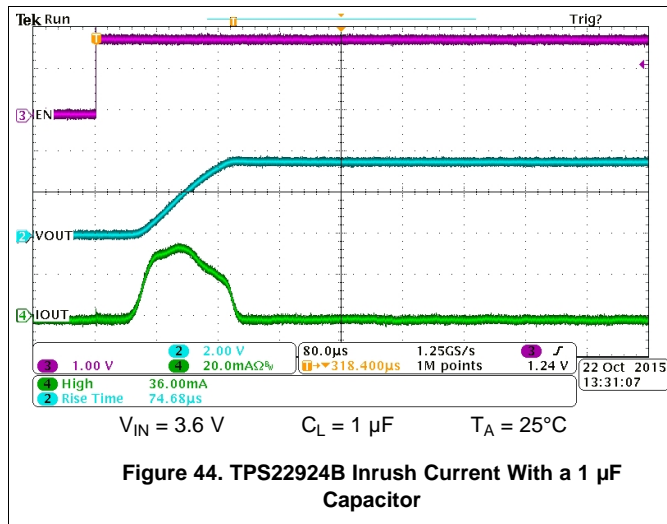

## 11 Power Supply Recommendations

The device is designed to operate with a  $V_{IN}$  range of 0.75 V to 3.6 V. This supply must be well regulated and placed as close to the device terminal as possible with the recommended 1  $\mu\text{F}$  bypass capacitor. If the supply is located more than a few inches from the device terminals, additional bulk capacitance may be required in addition to the ceramic bypass capacitors. If additional bulk capacitance is required, an electrolytic, tantalum, or ceramic capacitor of 10  $\mu\text{F}$  may be sufficient.

## 12 Layout

### 12.1 Layout Guidelines

For best performance, all traces should be as short as possible. To be most effective, the input and output capacitors should be placed close to the device to minimize the effects that parasitic trace inductances may have on normal and short-circuit operation. Using wide traces for  $V_{IN}$ ,  $V_{OUT}$ , and GND helps minimize the parasitic electrical effects.

### 12.2 Layout Example

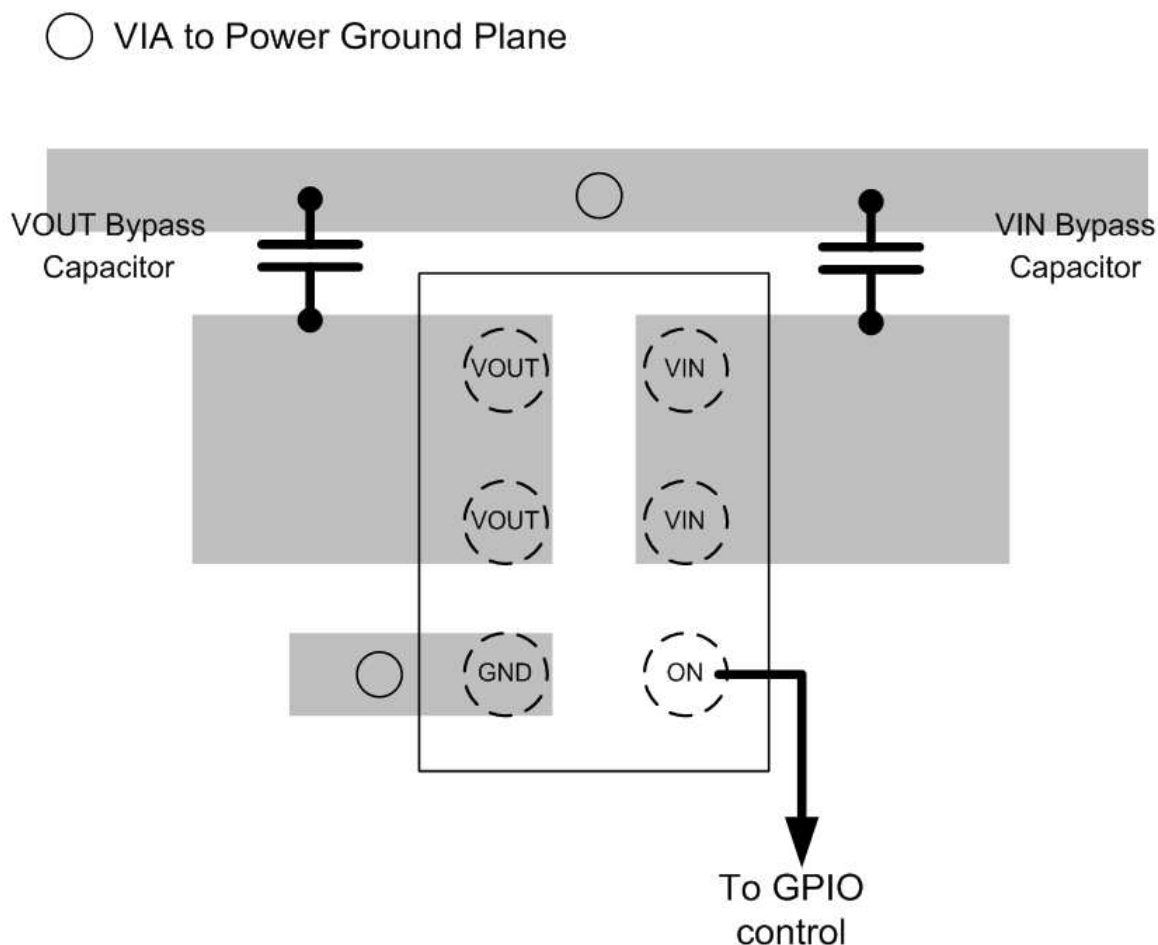

**Figure 46. TPS22924x Layout Example**

## 13 Device and Documentation Support

### 13.1 Related Links

The table below lists quick access links. Categories include technical documents, support and community resources, tools and software, and quick access to sample or buy.

**Table 2. Related Links**

PARTS	PRODUCT FOLDER	SAMPLE & BUY	TECHNICAL DOCUMENTS	TOOLS & SOFTWARE	SUPPORT & COMMUNITY
TPS22924B	<a href="#">Click here</a>	<a href="#">Click here</a>	<a href="#">Click here</a>	<a href="#">Click here</a>	<a href="#">Click here</a>
TPS22924C	<a href="#">Click here</a>	<a href="#">Click here</a>	<a href="#">Click here</a>	<a href="#">Click here</a>	<a href="#">Click here</a>

### 13.2 Community Resources

The following links connect to TI community resources. Linked contents are provided "AS IS" by the respective contributors. They do not constitute TI specifications and do not necessarily reflect TI's views; see TI's [Terms of Use](#).

**TI E2E™ Online Community** *TI's Engineer-to-Engineer (E2E) Community*. Created to foster collaboration among engineers. At [e2e.ti.com](http://e2e.ti.com), you can ask questions, share knowledge, explore ideas and help solve problems with fellow engineers.

**Design Support** *TI's Design Support* Quickly find helpful E2E forums along with design support tools and contact information for technical support.

### 13.3 Trademarks

E2E is a trademark of Texas Instruments.  
 All other trademarks are the property of their respective owners.

### 13.4 Electrostatic Discharge Caution



These devices have limited built-in ESD protection. The leads should be shorted together or the device placed in conductive foam during storage or handling to prevent electrostatic damage to the MOS gates.

### 13.5 Glossary

**SLYZ022** — *TI Glossary*.

This glossary lists and explains terms, acronyms, and definitions.

## 14 Mechanical, Packaging, and Orderable Information

The following pages include mechanical, packaging, and orderable information. This information is the most current data available for the designated devices. This data is subject to change without notice and revision of this document. For browser-based versions of this data sheet, refer to the left-hand navigation.

**PACKAGING INFORMATION**

Orderable Device	Status (1)	Package Type	Package Drawing	Pins	Package Qty	Eco Plan (2)	Lead/Ball Finish (6)	MSL Peak Temp (3)	Op Temp (°C)	Device Marking (4/5)	Samples
TPS22924BYZPRB	ACTIVE	DSBGA	YZP	6	3000	Green (RoHS & no Sb/Br)	SNAGCU	Level-1-260C-UNLIM	-40 to 85	5N	<a href="#">Samples</a>
TPS22924BYZR	ACTIVE	DSBGA	YZ	6	3000	Green (RoHS & no Sb/Br)	SNAGCU	Level-1-260C-UNLIM	-40 to 85	5N	<a href="#">Samples</a>
TPS22924BYZT	ACTIVE	DSBGA	YZ	6	250	Green (RoHS & no Sb/Br)	SNAGCU	Level-1-260C-UNLIM	-40 to 85	5N	<a href="#">Samples</a>
TPS22924BYZZR	ACTIVE	DSBGA	YZZ	6	3000	Green (RoHS & no Sb/Br)	SNAGCU	Level-1-260C-UNLIM	-40 to 85	7A	<a href="#">Samples</a>
TPS22924BYZZT	ACTIVE	DSBGA	YZZ	6	250	Green (RoHS & no Sb/Br)	SNAGCU	Level-1-260C-UNLIM	-40 to 85	7A	<a href="#">Samples</a>
TPS22924CYZPR	ACTIVE	DSBGA	YZP	6	3000	Green (RoHS & no Sb/Br)	SNAGCU	Level-1-260C-UNLIM	-40 to 85	(5L ~ 5LG)	<a href="#">Samples</a>
TPS22924CYZPRB	ACTIVE	DSBGA	YZP	6	3000	Green (RoHS & no Sb/Br)	SNAGCU	Level-1-260C-UNLIM	-40 to 85	5L	<a href="#">Samples</a>
TPS22924CYZPT	ACTIVE	DSBGA	YZP	6	250	Green (RoHS & no Sb/Br)	SNAGCU	Level-1-260C-UNLIM	-40 to 85	(5LF ~ 5LG)	<a href="#">Samples</a>

(1) The marketing status values are defined as follows:

**ACTIVE:** Product device recommended for new designs.

**LIFEBUY:** TI has announced that the device will be discontinued, and a lifetime-buy period is in effect.

**NRND:** Not recommended for new designs. Device is in production to support existing customers, but TI does not recommend using this part in a new design.

**PREVIEW:** Device has been announced but is not in production. Samples may or may not be available.

**OBSELETE:** TI has discontinued the production of the device.

(2) Eco Plan - The planned eco-friendly classification: Pb-Free (RoHS), Pb-Free (RoHS Exempt), or Green (RoHS & no Sb/Br) - please check <http://www.ti.com/productcontent> for the latest availability information and additional product content details.

**TBD:** The Pb-Free/Green conversion plan has not been defined.

**Pb-Free (RoHS):** TI's terms "Lead-Free" or "Pb-Free" mean semiconductor products that are compatible with the current RoHS requirements for all 6 substances, including the requirement that lead not exceed 0.1% by weight in homogeneous materials. Where designed to be soldered at high temperatures, TI Pb-Free products are suitable for use in specified lead-free processes.

**Pb-Free (RoHS Exempt):** This component has a RoHS exemption for either 1) lead-based flip-chip solder bumps used between the die and package, or 2) lead-based die adhesive used between the die and leadframe. The component is otherwise considered Pb-Free (RoHS compatible) as defined above.

**Green (RoHS & no Sb/Br):** TI defines "Green" to mean Pb-Free (RoHS compatible), and free of Bromine (Br) and Antimony (Sb) based flame retardants (Br or Sb do not exceed 0.1% by weight in homogeneous material)

(3) MSL, Peak Temp. - The Moisture Sensitivity Level rating according to the JEDEC industry standard classifications, and peak solder temperature.

(4) There may be additional marking, which relates to the logo, the lot trace code information, or the environmental category on the device.

(5) Multiple Device Markings will be inside parentheses. Only one Device Marking contained in parentheses and separated by a "~" will appear on a device. If a line is indented then it is a continuation of the previous line and the two combined represent the entire Device Marking for that device.

(6) Lead/Ball Finish - Orderable Devices may have multiple material finish options. Finish options are separated by a vertical ruled line. Lead/Ball Finish values may wrap to two lines if the finish value exceeds the maximum column width.

**Important Information and Disclaimer:**The information provided on this page represents TI's knowledge and belief as of the date that it is provided. TI bases its knowledge and belief on information provided by third parties, and makes no representation or warranty as to the accuracy of such information. Efforts are underway to better integrate information from third parties. TI has taken and continues to take reasonable steps to provide representative and accurate information but may not have conducted destructive testing or chemical analysis on incoming materials and chemicals. TI and TI suppliers consider certain information to be proprietary, and thus CAS numbers and other limited information may not be available for release.

In no event shall TI's liability arising out of such information exceed the total purchase price of the TI part(s) at issue in this document sold by TI to Customer on an annual basis.

**TAPE AND REEL INFORMATION**

**QUADRANT ASSIGNMENTS FOR PIN 1 ORIENTATION IN TAPE**

\*All dimensions are nominal

Device	Package Type	Package Drawing	Pins	SPQ	Reel Diameter (mm)	Reel Width W1 (mm)	A0 (mm)	B0 (mm)	K0 (mm)	P1 (mm)	W (mm)	Pin1 Quadrant
TPS22924BYZPRB	DSBGA	YZP	6	3000	178.0	9.2	1.02	1.52	0.63	4.0	8.0	Q1
TPS22924BYZR	DSBGA	YZ	6	3000	178.0	9.2	1.02	1.52	0.63	4.0	8.0	Q1
TPS22924BYZT	DSBGA	YZ	6	250	178.0	9.2	1.02	1.52	0.63	4.0	8.0	Q1
TPS22924BYZZR	DSBGA	YZZ	6	3000	178.0	9.2	1.02	1.52	0.5	4.0	8.0	Q1
TPS22924BYZZT	DSBGA	YZZ	6	250	178.0	9.2	1.02	1.52	0.5	4.0	8.0	Q1
TPS22924CYZPR	DSBGA	YZP	6	3000	178.0	9.2	1.02	1.52	0.63	4.0	8.0	Q1
TPS22924CYZPRB	DSBGA	YZP	6	3000	178.0	9.2	1.02	1.52	0.63	4.0	8.0	Q1
TPS22924CYZPT	DSBGA	YZP	6	250	178.0	9.2	1.02	1.52	0.63	4.0	8.0	Q1

**TAPE AND REEL BOX DIMENSIONS**

\*All dimensions are nominal

Device	Package Type	Package Drawing	Pins	SPQ	Length (mm)	Width (mm)	Height (mm)
TPS22924BYZPRB	DSBGA	YZP	6	3000	220.0	220.0	35.0
TPS22924BYZR	DSBGA	YZ	6	3000	220.0	220.0	35.0
TPS22924BYZT	DSBGA	YZ	6	250	220.0	220.0	35.0
TPS22924BYZZR	DSBGA	YZZ	6	3000	220.0	220.0	35.0
TPS22924BYZZT	DSBGA	YZZ	6	250	220.0	220.0	35.0
TPS22924CZPR	DSBGA	YZP	6	3000	220.0	220.0	35.0
TPS22924CZPRB	DSBGA	YZP	6	3000	220.0	220.0	35.0
TPS22924CZPT	DSBGA	YZP	6	250	220.0	220.0	35.0

YZZ (R-XBGA-N6)

DIE-SIZE BALL GRID ARRAY

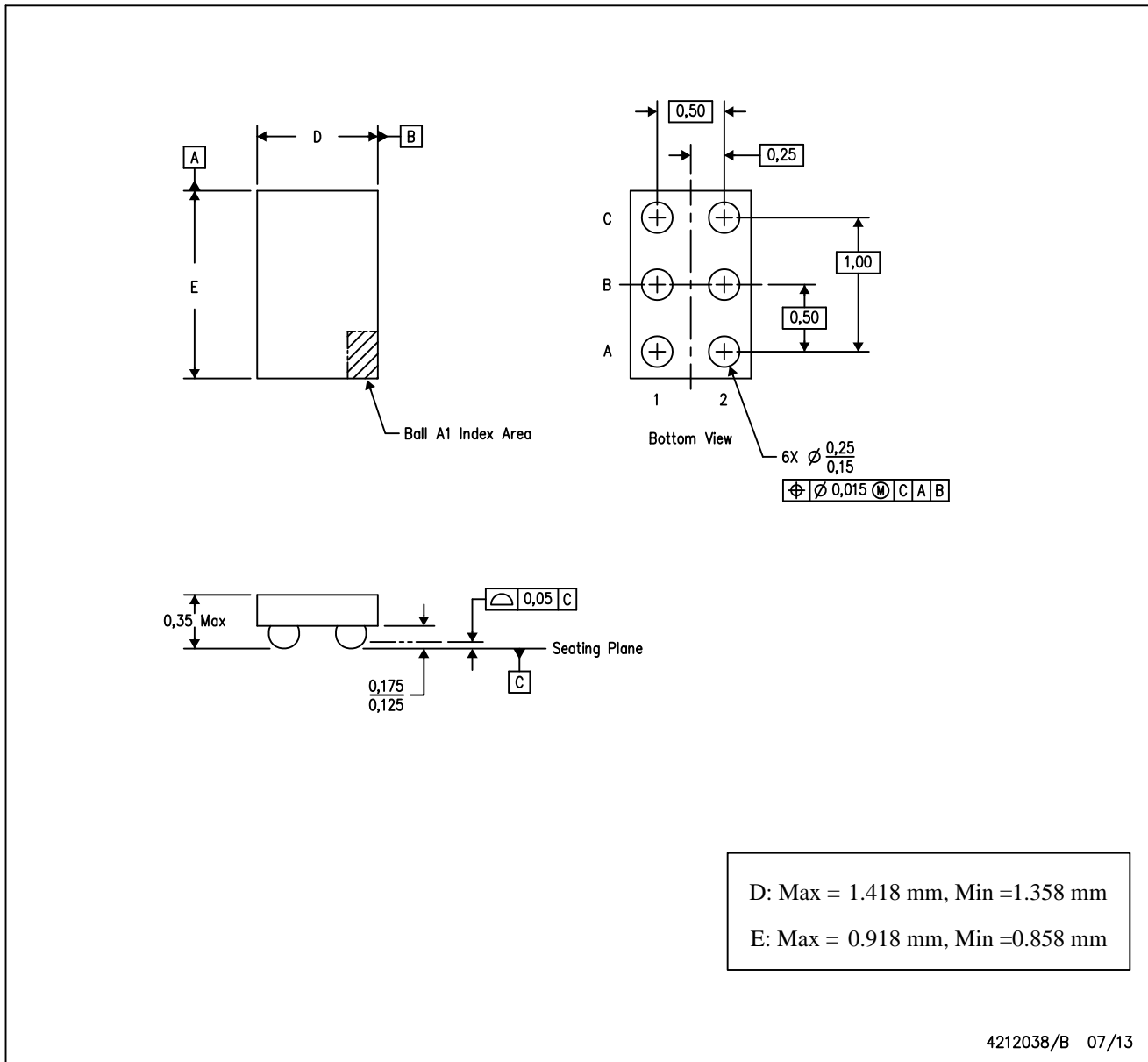

- NOTES:
- A. All linear dimensions are in millimeters. Dimensioning and tolerancing per ASME Y14.5M-1994.
  - B. This drawing is subject to change without notice.
  - C. NanoFree™ package configuration.

YZP0006



PACKAGE OUTLINE

DSBGA - 0.5 mm max height

DIE SIZE BALL GRID ARRAY

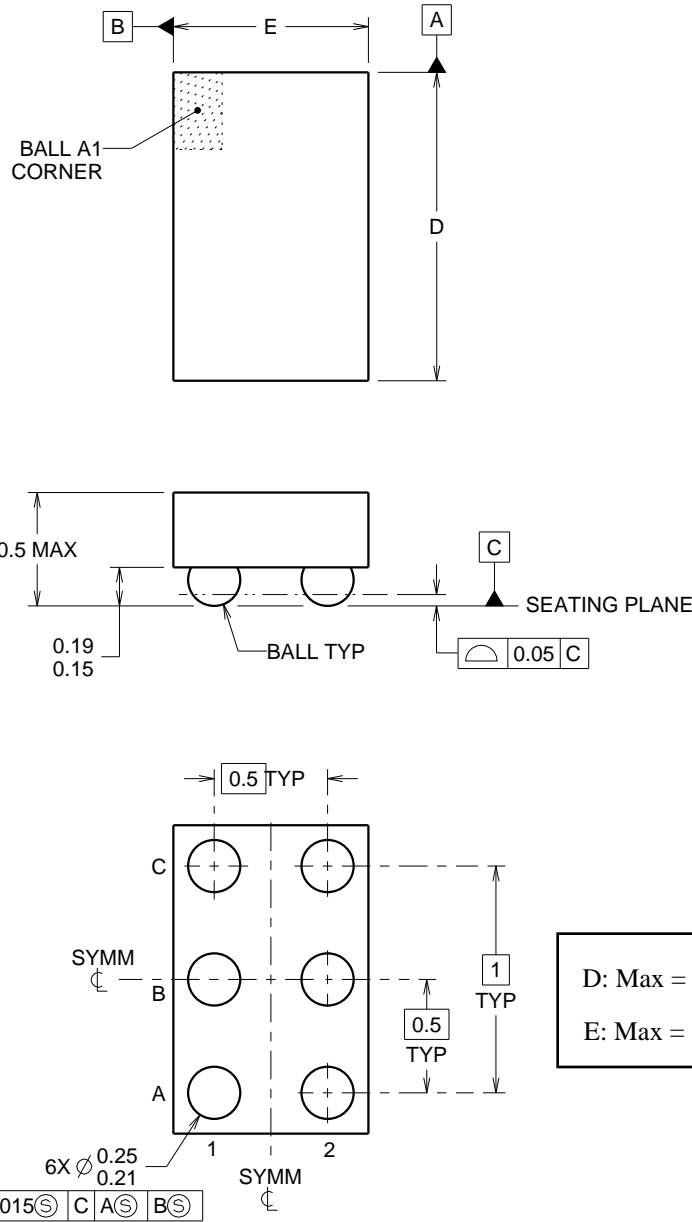

D: Max = 1.418 mm, Min = 1.358 mm  
 E: Max = 0.918 mm, Min = 0.858 mm

4219524/A 06/2014

NOTES:

NanoFree Is a trademark of Texas Instruments.

1. All linear dimensions are in millimeters. Any dimensions in parenthesis are for reference only. Dimensioning and tolerancing per ASME Y14.5M.
2. This drawing is subject to change without notice.
3. NanoFree™ package configuration.

# EXAMPLE BOARD LAYOUT

YZP0006

DSBGA - 0.5 mm max height

DIE SIZE BALL GRID ARRAY



LAND PATTERN EXAMPLE  
SCALE:40X

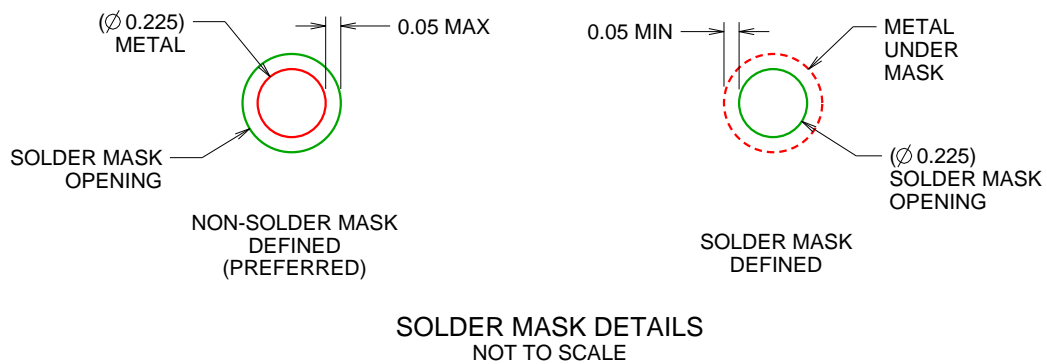

SOLDER MASK DETAILS  
NOT TO SCALE

4219524/A 06/2014

NOTES: (continued)

- Final dimensions may vary due to manufacturing tolerance considerations and also routing constraints. For more information, see Texas Instruments literature number SBVA017 ([www.ti.com/lit/sbva017](http://www.ti.com/lit/sbva017)).

# EXAMPLE STENCIL DESIGN

YZP0006

DSBGA - 0.5 mm max height

DIE SIZE BALL GRID ARRAY

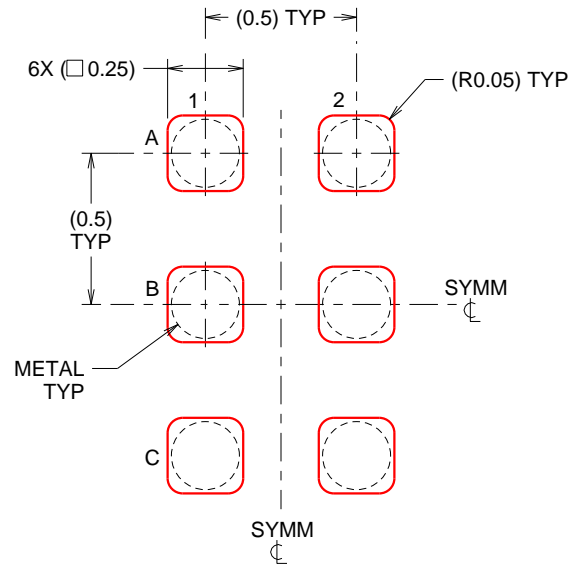

SOLDER PASTE EXAMPLE  
BASED ON 0.1 mm THICK STENCIL  
SCALE:40X

4219524/A 06/2014

NOTES: (continued)

5. Laser cutting apertures with trapezoidal walls and rounded corners may offer better paste release.

## IMPORTANT NOTICE AND DISCLAIMER

TI PROVIDES TECHNICAL AND RELIABILITY DATA (INCLUDING DATASHEETS), DESIGN RESOURCES (INCLUDING REFERENCE DESIGNS), APPLICATION OR OTHER DESIGN ADVICE, WEB TOOLS, SAFETY INFORMATION, AND OTHER RESOURCES "AS IS" AND WITH ALL FAULTS, AND DISCLAIMS ALL WARRANTIES, EXPRESS AND IMPLIED, INCLUDING WITHOUT LIMITATION ANY IMPLIED WARRANTIES OF MERCHANTABILITY, FITNESS FOR A PARTICULAR PURPOSE OR NON-INFRINGEMENT OF THIRD PARTY INTELLECTUAL PROPERTY RIGHTS.

These resources are intended for skilled developers designing with TI products. You are solely responsible for (1) selecting the appropriate TI products for your application, (2) designing, validating and testing your application, and (3) ensuring your application meets applicable standards, and any other safety, security, or other requirements. These resources are subject to change without notice. TI grants you permission to use these resources only for development of an application that uses the TI products described in the resource. Other reproduction and display of these resources is prohibited. No license is granted to any other TI intellectual property right or to any third party intellectual property right. TI disclaims responsibility for, and you will fully indemnify TI and its representatives against, any claims, damages, costs, losses, and liabilities arising out of your use of these resources.

TI's products are provided subject to TI's Terms of Sale ([www.ti.com/legal/termsofsale.html](http://www.ti.com/legal/termsofsale.html)) or other applicable terms available either on [ti.com](http://ti.com) or provided in conjunction with such TI products. TI's provision of these resources does not expand or otherwise alter TI's applicable warranties or warranty disclaimers for TI products.

Mailing Address: Texas Instruments, Post Office Box 655303, Dallas, Texas 75265  
Copyright © 2019, Texas Instruments Incorporated

## Looking for pricing, stock, or lifecycle information?

Click below to explore more details on WIN SOURCE:

 [View TPS22924CZPR on WIN SOURCE](#)

 [Texas Instruments](#) Information

## Optimize Your Supply Chain with WIN SOURCE Solutions

-  Global Sourcing Solution
-  Obsolete Management
-  Cost Control Management
-  Shortage Management
-  Alternative Solution
-  Excess Inventory Management