



**THE DATASHEET OF
TPS40304DRCR**



TPS4030x 3-V to 20-V Input, Voltage Mode, Synchronous Buck Controller

1 Features

- Input Voltage Range From 3 V to 20 V
- 300-kHz (TPS40303), 600-kHz (TPS40304), and 1.2-MHz (TPS40305) Switching Frequencies
- High- and Low-Side FET $R_{DS(on)}$ Current Sensing
- Programmable Thermally Compensated OCP Levels
- Programmable Soft Start
- 600-mV, 1% Reference Voltage
- Voltage Feed-Forward Compensation
- Supports Prebiased Output
- Frequency Spread Spectrum
- Thermal Shutdown Protection at 145°C
- 10-Pin 3-mm x 3-mm VSON Package With Ground Connection to Thermal Pad
- Create a Custom Design Using the TPS4030x With the [WEBENCH® Power Designer](#)

2 Applications

- POL Modules
- Printers
- Digital TVs
- Telecom
- USB Type-C Wall Receptacles

3 Description

The TPS4030x is a family of cost-optimized synchronous buck controllers that operate from 3-V to 20-V input. The controller implements a voltage-mode control architecture with input-voltage feed-forward compensation that responds instantly to a change in input voltage. The switching frequency is fixed at 300 kHz, 600 kHz, or 1.2 MHz.

The frequency spread-spectrum (FSS) feature adds to the switching frequency, significantly reducing the peak EMI noise and making it much easier to comply with EMI standards.

The TPS4030x offers design with a variety of user-programmable functions, including soft start, overcurrent protection (OCP) levels, and loop compensation.

OCP level may be programmed by a single external resistor connected from the LDRV pin to circuit ground. During initial power on, the TPS4030x enters a calibration cycle, measures the voltage at the LDRV pin, and sets an internal OCP voltage level. During operation, the programmed OCP voltage level is compared to the voltage drop across the low-side FET when it is on to determine whether there is an overcurrent condition. The TPS4030x then enters a shutdown and restart cycle until the fault is removed.

Device Information⁽¹⁾

PART NUMBER	PACKAGE	BODY SIZE (NOM)
TPS40303	VSON (10)	3.00 mm x 3.00 mm
TPS40304		
TPS40305		

(1) For all available packages, see the orderable addendum at the end of the data sheet.

Simplified Application Diagram

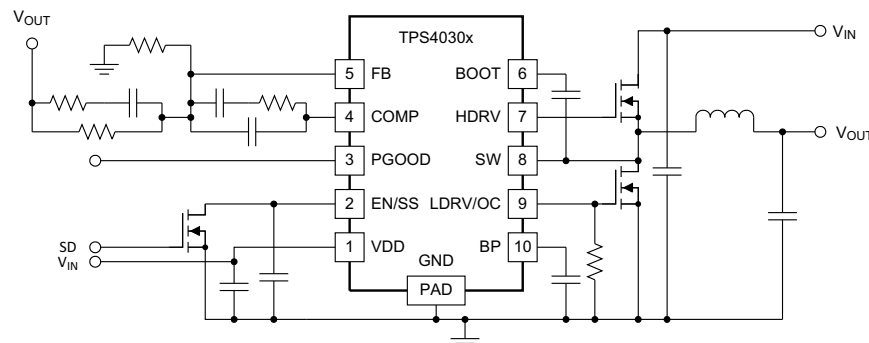

Copyright © 2017, Texas Instruments Incorporated



Table of Contents

1 Features 1 2 Applications 1 3 Description 1 4 Revision History 2 5 Pin Configuration and Functions 3 6 Specifications 4 6.1 Absolute Maximum Ratings 4 6.2 ESD Ratings 4 6.3 Recommended Operating Conditions 4 6.4 Thermal Information 4 6.5 Electrical Characteristics 5 6.6 Typical Characteristics 7 7 Detailed Description 9 7.1 Overview 9 7.2 Functional Block Diagram 9 7.3 Feature Description 9 7.4 Device Functional Modes 13 8 Application and Implementation 14	8.1 Application Information 14 8.2 Typical Applications 14 9 Power Supply Recommendations 29 10 Layout 30 10.1 Layout Guidelines 30 10.2 Layout Example 31 11 Device and Documentation Support 32 11.1 Device Support 32 11.2 Custom Design With WEBENCH® Tools 32 11.3 Documentation Support 32 11.4 Related Links 32 11.5 Receiving Notification of Documentation Updates 32 11.6 Community Resources 33 11.7 Trademarks 33 11.8 Electrostatic Discharge Caution 33 11.9 Glossary 33 12 Mechanical, Packaging, and Orderable Information 33
---	---

4 Revision History

NOTE: Page numbers for previous revisions may differ from page numbers in the current version.

Changes from Revision C (January 2018) to Revision D	Page
• Changed title of data sheet for SEO	1
• Added "USB Type-C Wall Receptacles" to Applications ; added links for WEBENCH	1
• Deleted redundant <i>Dissipation Ratings</i> table	4

Changes from Revision B (May 2015) to Revision C	Page
• Added top nav icon for TPS40303 TI Design	1
• Deleted Related Devices table from Device and Documentation Support	32

Changes from Revision A (August 2012) to Revision B	Page
• Added <i>Pin Configuration and Functions</i> section, <i>ESD Ratings</i> table, <i>Feature Description</i> section, <i>Device Functional Modes</i> , <i>Application and Implementation</i> section, <i>Power Supply Recommendations</i> section, <i>Layout</i> section, <i>Device and Documentation Support</i> section, and <i>Mechanical, Packaging, and Orderable Information</i> section	1

Changes from Original (November 2009) to Revision A	Page
• Changed minimum controllable pulse width max value from 100 to 70	5

5 Pin Configuration and Functions

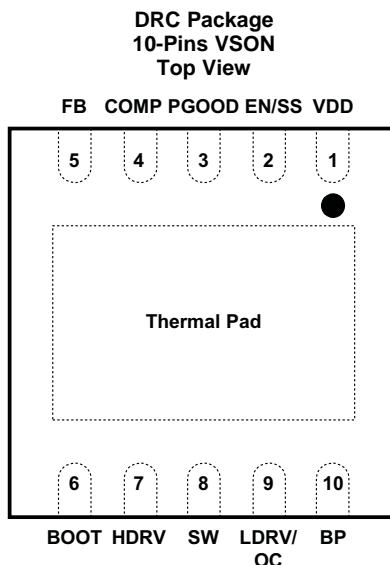

PIN		I/O	DESCRIPTION
NAME	NO.		
BOOT	6	I	Gate drive voltage for the high-side N-channel MOSFET. A 0.1- μ F capacitor (typical) must be connected between this pin and SW. For low input voltage operation, an external schottky diode from BP to BOOT is recommended to maximize the gate drive voltage for the high-side.
BP	10	O	Output bypass for the internal regulator. Connect a low ESR bypass ceramic capacitor of 1 μ F or greater from this pin to GND.
COMP	4	O	Output of the error amplifier and connection node for loop feedback components.
EN/SS	2	I	Logic level input which starts or stops the controller via an external user command. Letting this pin float turns the controller on. Pulling this pin low disables the controller. This is also the soft-start programming pin. A capacitor connected from this pin to GND programs the soft-start time. The capacitor is charged with an internal current source of 10 μ A. The resulting voltage ramp of this pin is also used as a second non-inverting input to the error amplifier after a 0.8 V (typical) level shift downwards. Output regulation is controlled by the internal level shifted voltage ramp until that voltage reaches the internal reference voltage of 600 mV – the voltage ramp of this pin reaches 1.4 V (typical). Optionally, a 267-k Ω resistor from this pin to BP enables the FSS feature.
FB	5	I	Inverting input to the error amplifier. In normal operation, the voltage on this pin is equal to the internal reference voltage.
HDRV	7	O	Bootstrapped gate drive output for the high-side N-channel MOSFET.
LDRV/OC	9	O	Gate drive output for the low-side synchronous rectifier N-channel MOSFET. A resistor from this pin to GND is also used to determine the voltage level for OCP. An internal current source of 10 μ A flows through the resistor during initial calibration and that sets up the voltage trip point used for OCP.
PGOOD	3	O	Open-drain power good output.
SW	8	O	Sense line for the adaptive anti-cross conduction circuitry. Serves as common connection for the flying high-side FET driver.
VDD	1	I	Power input to the controller. Bypass VDD to GND with a low ESR ceramic capacitor of at least 1- μ F close to the device.
GND	Thermal Pad	—	Ground connection to the controller. This is also the thermal pad used to conduct heat from the device. This connection serves a twofold purpose. The first is to provide an electrical ground connection for the device. The second is to provide a low thermal impedance path from the device die to the PCB. This pad should be tied externally to a ground plane.

6 Specifications

6.1 Absolute Maximum Ratings

over operating free-air temperature range (unless otherwise noted)⁽¹⁾

	MIN	MAX	UNIT
VDD	-0.3	22	V
SW	-3	27	V
SW (< 100-ns pulse width, 10 μ J)		-5	V
BOOT	-0.3	30	V
HDRV	-5	30	V
BOOT-SW, HDRV-SW (differential from BOOT or HDRV to SW)	-0.3	7	V
COMP, PGOOD, FB, BP, LDRV, EN/SS	-0.3	7	V
Operating junction temperature, T _J	-40	145	°C
Storage temperature, T _{stg}	-55	150	°C

- (1) Stresses beyond those listed under Absolute Maximum Ratings may cause permanent damage to the device. These are stress ratings only and functional operation of the device at these or any other condition beyond those included under [Recommended Operating Conditions](#) is not implied. Exposure to absolute-maximum-rated conditions for extended periods of time may affect device reliability.

6.2 ESD Ratings

		VALUE	UNIT
V _(ESD) Electrostatic discharge	Human-body model (HBM), per ANSI/ESDA/JEDEC JS-001 ⁽¹⁾	±2000	V
	Charged-device model (CDM), per JEDEC specification JESD22-C101 ⁽²⁾	±1500	

- (1) JEDEC document JEP155 states that 500-V HBM allows safe manufacturing with a standard ESD control process.
 (2) JEDEC document JEP157 states that 250-V CDM allows safe manufacturing with a standard ESD control process.

6.3 Recommended Operating Conditions

		MIN	NOM	MAX	UNIT
VDD	Input voltage	3		20	V
T _J	Operating junction temperature	-40		125	°C

6.4 Thermal Information

THERMAL METRIC ⁽¹⁾		TPS4030x	UNIT
		DRC (VSON)	
		10 PINS	
R _{θJA}	Junction-to-ambient thermal resistance	44.3	°C/W
R _{θJC(top)}	Junction-to-case (top) thermal resistance	56.1	°C/W
R _{θJB}	Junction-to-board thermal resistance	19.2	°C/W
ψ _{JT}	Junction-to-top characterization parameter	0.7	°C/W
ψ _{JB}	Junction-to-board characterization parameter	19.4	°C/W
R _{θJC(bot)}	Junction-to-case (bottom) thermal resistance	5.5	°C/W

- (1) For more information about traditional and new thermal metrics, see the [Semiconductor and IC Package Thermal Metrics](#) application report.

6.5 Electrical Characteristics

$T_J = -40^\circ\text{C}$ to 125°C , $V_{VDD} = 12\text{ V}$, all parameters at zero power dissipation (unless otherwise noted)

PARAMETER		TEST CONDITIONS	MIN	TYP	MAX	UNIT	
VOLTAGE REFERENCE							
V_{FB}	FB input voltage	$T_J = 25^\circ\text{C}$, $3\text{ V} < V_{VDD} < 20\text{ V}$	597	600	603	mV	
		$-40^\circ\text{C} < T_J < 125^\circ\text{C}$, $3\text{ V} < V_{VDD} < 20\text{ V}$	594	600	606		
INPUT SUPPLY							
V_{VDD}	Input supply voltage range		3		20	V	
I_{DDSD}	Shutdown supply current	$V_{EN/SS} < 0.2\text{ V}$		70	100	μA	
I_{DDQ}	Quiescent, nonswitching	Let EN/SS float, $V_{FB} = 1\text{ V}$		2.5	3.5	mA	
ENABLE/SOFT START							
V_{IH}	High-level input voltage, EN/SS		0.55	0.7	1	V	
V_{IL}	Low-level input voltage, EN/SS		0.27	0.3	0.33	V	
I_{SS}	Soft-start source current		8	10	12	μA	
V_{SS}	Soft-start voltage level		0.4	0.8	1.3	V	
BP REGULATOR							
V_{BP}	Output voltage	$I_{BP} = 10\text{ mA}$	6.2	6.5	6.8	V	
V_{DO}	Regulator dropout voltage, $V_{VDD} - V_{BP}$	$I_{BP} = 25\text{ mA}$, $V_{VDD} = 3\text{ V}$		70	110	mV	
OSCILLATOR							
f_{SW}	PWM frequency	TPS40303	$3\text{ V} < V_{VDD} < 20\text{ V}$	270	300	330	kHz
		TPS40304		540	600	660	
		TPS40305		1.02	1.20	1.38	
$V_{RAMP}^{(1)}$	Ramp amplitude		$V_{VDD}/6.6$	$V_{VDD}/6$	$V_{VDD}/5.4$	V	
f_{SWFSS}	Frequency spread-spectrum frequency deviation		12%			f_{sw}	
f_{MOD}	Modulation frequency			25		kHz	
PWM							
$D_{MAX}^{(1)}$	Maximum duty cycle	TPS40303	$V_{FB} = 0\text{ V}$, $3\text{ V} < V_{VDD} < 20\text{ V}$	90%			
		TPS40304		90%			
		TPS40305		85%			
$t_{ON(min)}^{(1)}$	Minimum controllable pulse width				70	ns	
t_{DEAD}	Output driver dead time	HDRV off to LDRV on	5	25	35	ns	
		LDRV off to HDRV on	5	25	30		
ERROR AMPLIFIER							
$G_{BWP}^{(1)}$	Gain bandwidth product		10	24		MHz	
$A_{OL}^{(1)}$	Open loop gain		60			dB	
I_{IB}	Input bias current (current out of FB pin)	$V_{FB} = 0.6\text{ V}$			75	nA	
I_{EAOP}	Output source current	$V_{FB} = 0\text{ V}$	2			mA	
I_{EAOM}	Output sink current	$V_{FB} = 1\text{ V}$	2				
PGOOD							
V_{OV}	Feedback upper voltage limit for PGOOD		655	675	700	mV	
V_{UV}	Feedback lower voltage limit for PGOOD		500	525	550		
$V_{PGD-HYST}$	PGOOD hysteresis voltage at FB			25	40		
R_{PGD}	PGOOD pulldown resistance	$V_{FB} = 0\text{ V}$, $I_{FB} = 5\text{ mA}$		30	70	Ω	
I_{PGDLK}	PGOOD leakage current	$550\text{ mV} < V_{FB} < 655\text{ mV}$, $V_{PGOOD} = 5\text{ V}$		10	20	μA	

(1) Ensured by design. Not production tested.

Electrical Characteristics (continued)
 $T_J = -40^{\circ}\text{C}$ to 125°C , $V_{DD} = 12\text{ V}$, all parameters at zero power dissipation (unless otherwise noted)

PARAMETER		TEST CONDITIONS	MIN	TYP	MAX	UNIT
OUTPUT DRIVERS						
R_{HDHI}	High-side driver pullup resistance	$V_{BOOT} - V_{SW} = 5\text{ V}$, $I_{HDRV} = -100\text{ mA}$	0.8	1.5	2.5	Ω
R_{HDLO}	High-side driver pulldown resistance	$V_{BOOT} - V_{SW} = 5\text{ V}$, $I_{HDRV} = 100\text{ mA}$	0.5	1	2.2	Ω
R_{LDHI}	Low-side driver pullup resistance	$I_{LDRV} = -100\text{ mA}$	0.8	1.5	2.5	Ω
R_{LDLO}	Low-side driver pulldown resistance	$I_{LDRV} = 100\text{ mA}$	0.35	0.6	1.2	Ω
$t_{HRISE}^{(1)}$	High-side driver rise time	$C_{LOAD} = 5\text{ nF}$		15		ns
$t_{HFALL}^{(1)}$	High-side driver fall time			12		ns
$t_{LRISE}^{(1)}$	Low-side driver rise time			15		ns
$t_{LFALL}^{(1)}$	Low-side driver fall time			10		ns
OVERCURRENT PROTECTION						
$t_{PSSC(min)}^{(1)}$	Minimum pulse time during short circuit			250		ns
$t_{BLNKH}^{(1)}$	Switch leading-edge blanking pulse time			150		ns
V_{OCH}	OC threshold for high-side FET	$T_J = 25^{\circ}\text{C}$	360	450	580	mV
I_{OCSET}	OCSET current source	$T_J = 25^{\circ}\text{C}$	9.5	10	10.5	μA
$V_{LD-CLAMP}$	Maximum clamp voltage at LDRV		260	340	400	mV
V_{OCLOS}	OC comparator offset voltage for low-side FET	$T_J = 25^{\circ}\text{C}$	-8		8	mV
$V_{OCLPRO}^{(1)}$	Programmable OC range for low-side FET	$T_J = 25^{\circ}\text{C}$	12		300	mV
$V_{THTC}^{(1)}$	OC threshold temperature coefficient (both high-side and low-side)			3000		ppm
t_{OFF}	OC retry cycles on EN/SS pin			4		Cycle
BOOT DIODE						
V_{DFWD}	Bootstrap diode forward voltage	$I_{BOOT} = 5\text{ mA}$		0.8		V
THERMAL SHUTDOWN						
$T_{JSD}^{(1)}$	Junction shutdown temperature			145		$^{\circ}\text{C}$
$T_{JSDH}^{(1)}$	Hysteresis			20		$^{\circ}\text{C}$

6.6 Typical Characteristics

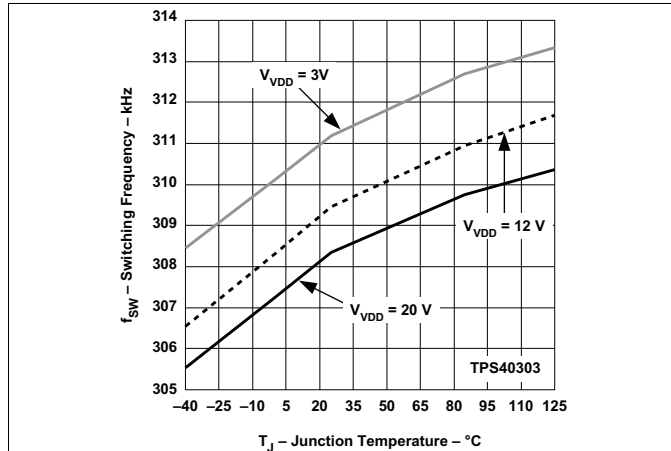

Figure 1. Switching Frequency vs Junction Temperature

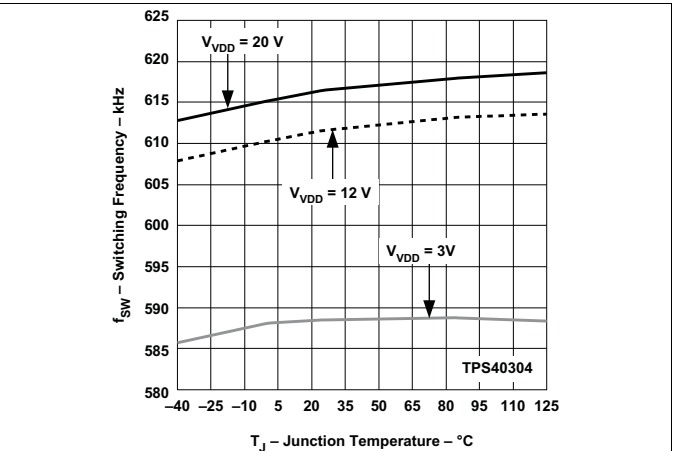

Figure 2. Switching Frequency vs Junction Temperature

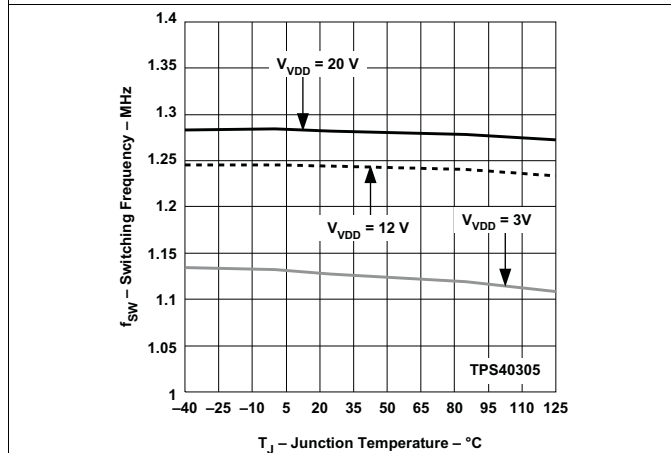

Figure 3. Switching Frequency vs Junction Temperature

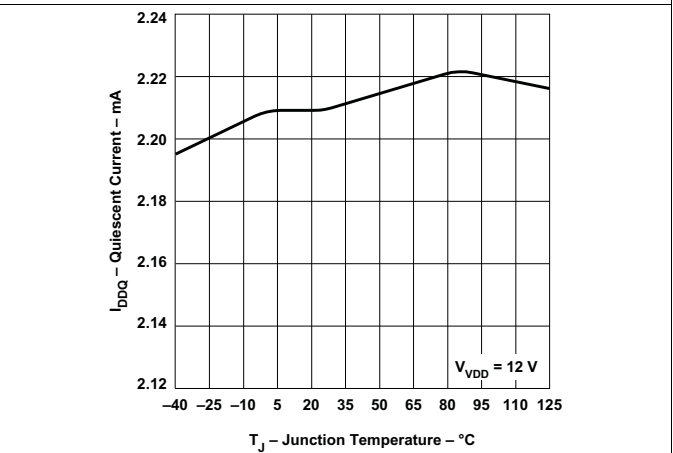

Figure 4. Quiescent Current vs Junction Temperature

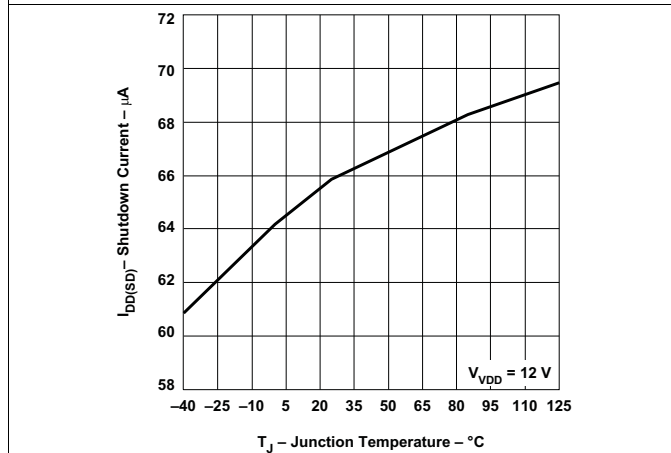

Figure 5. Shutdown Current vs Junction Temperature

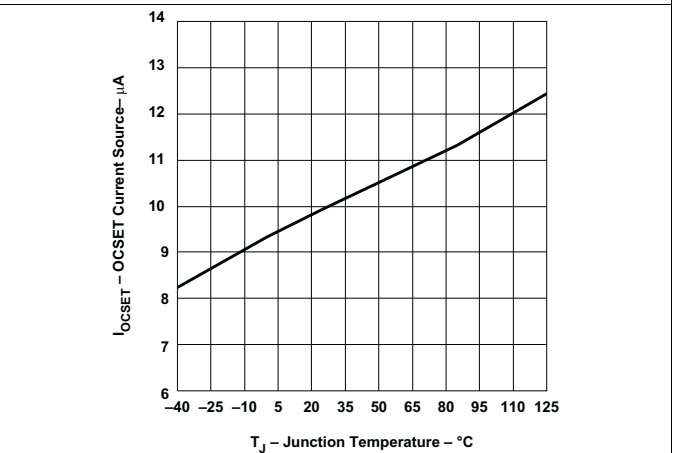

Figure 6. OCSET Current Source vs Junction Temperature

Typical Characteristics (continued)

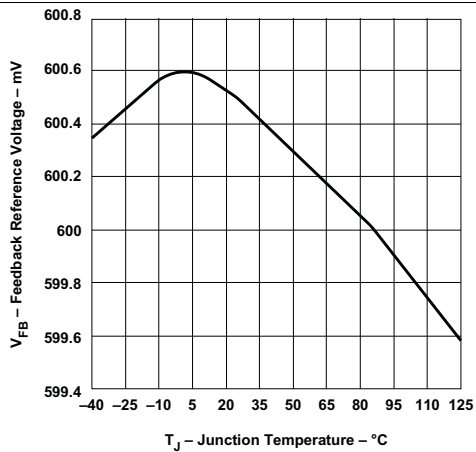

Figure 7. Feedback Reference Voltage vs Junction Temperature

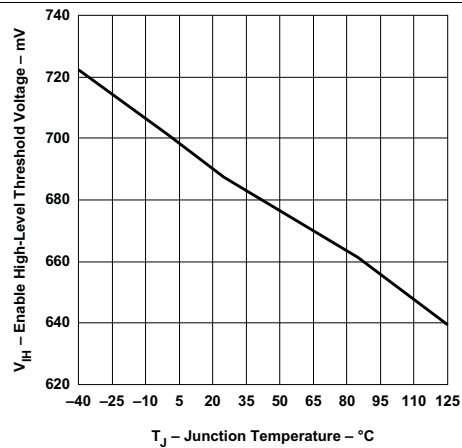

Figure 8. Enable High-Level Threshold Voltage vs Junction Temperature

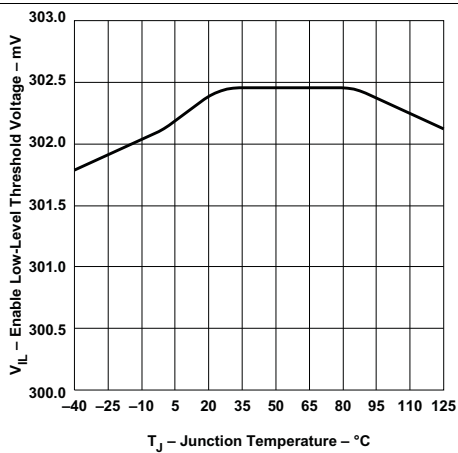

Figure 9. Enable Low-Level Threshold Voltage vs Junction Temperature

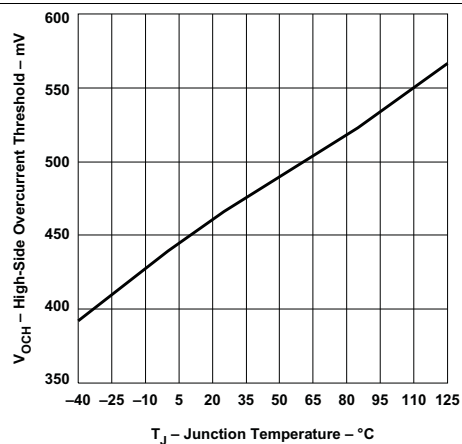

Figure 10. High-Side Overcurrent Threshold vs Junction Temperature

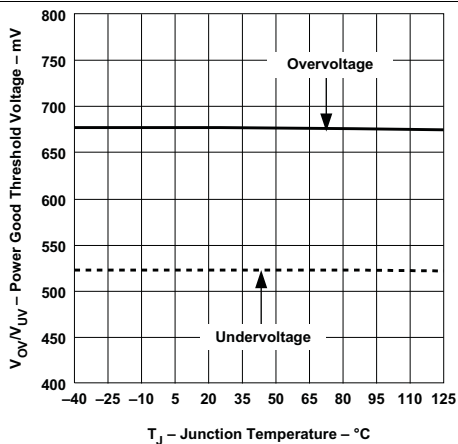

Figure 11. Power Good Threshold Voltage vs Junction Temperature

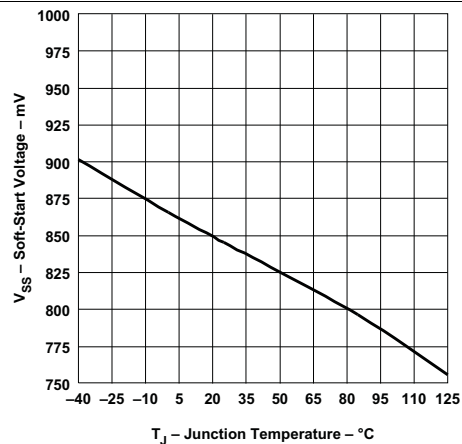

Figure 12. Soft-Start Voltage vs Junction Temperature

7 Detailed Description

7.1 Overview

The TPS4030x is a family of cost-optimized synchronous buck controllers providing high-end features to construct high-performance DC–DC converters. Prebias capability eliminates concerns about damaging sensitive loads during start-up. Programmable overcurrent protection levels and hiccup overcurrent fault recovery maximize design flexibility and minimize power dissipation in the event of a prolonged output short. The Frequency Spread Spectrum (FSS) feature reduces peak EMI noise by spreading the initial energy of each harmonic along a frequency band, thus giving a wider spectrum with lower amplitudes.

7.2 Functional Block Diagram

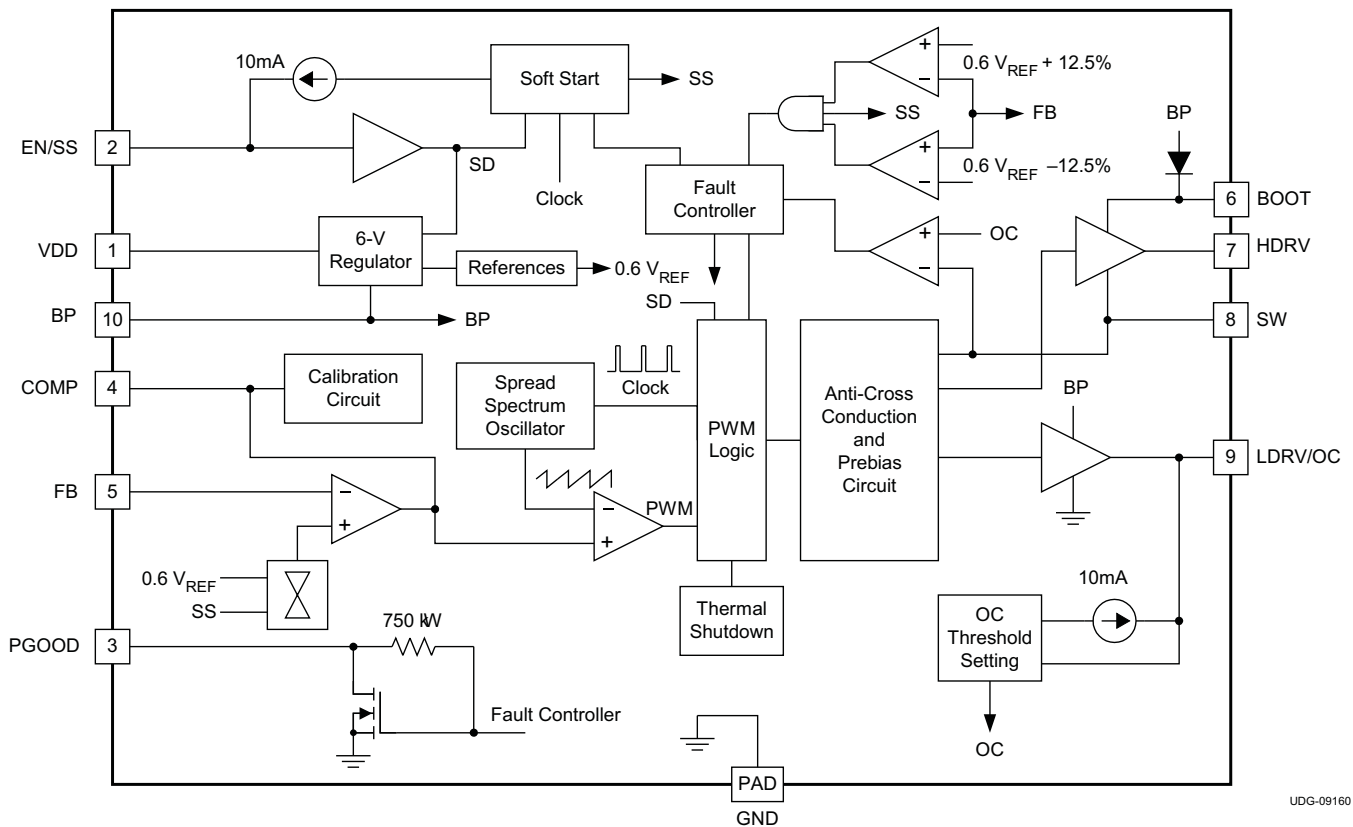

7.3 Feature Description

7.3.1 Voltage Reference

The 600-mV band gap cell is internally connected to the noninverting input of the error amplifier. The reference voltage is trimmed with the error amplifier in a unity gain configuration to remove amplifier offset from the final regulation voltage. The 1% tolerance on the reference voltage allows the user to design a very accurate power supply.

7.3.2 Enable Functionality, Start-Up Sequence and Timing

After input power is applied, an internal current source of 40 μ A starts to charge up the soft-start capacitor connected from EN/SS to GND. When the voltage across that capacitor increases to 0.7 V, it enables the internal BP regulator followed by a calibration. The total calibration time is about 1.9 ms. See Figure 13. During the calibration, the device performs in the following way. It disables the LDRV drive and injects an internal 10- μ A current source to the resistor connected from LDRV to GND. The voltage developed across that resistor is then sampled and latched internally as the OCP trip level until one cycles the input or toggles the EN/SS.

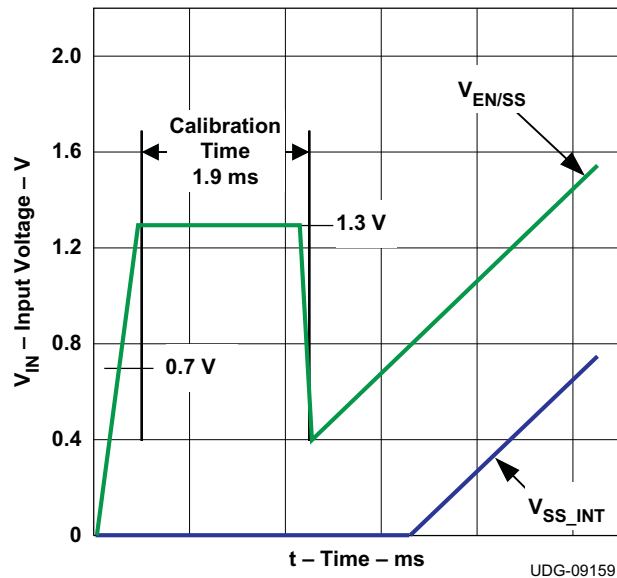
Feature Description (continued)

Figure 13. Start-Up Sequence and Timing

The voltage at EN/SS is internally clamped to 1.3 V before and/or during calibration to minimize the discharging time once calibration. The discharging current is from an internal current source of 140 μ A and it pulls the voltage down to 0.4 V. The discharging current then initiates the soft-start by charging up the capacitor using an internal current source of 10 μ A. The resulting voltage ramp on this pin is used as a second noninverting input to the error amplifier after an 800 mV (typical) downward level-shift; therefore, actual soft-start does not occur until the voltage at this pin reaches 800 mV.

If EN/SS is left floating, the controller starts automatically. EN/SS must be pulled down to less than 270 mV to ensure that the chip is in shutdown mode.

7.3.3 Soft-Start Time

The soft-start time of the TPS4030x is user programmable by selecting a single capacitor. The EN/SS pin sources 10 μ A to charge this capacitor. The actual output ramp-up time is the amount of time that it takes for the 10 μ A to charge the capacitor through a 600-mV range. There is some initial lag due to calibration and an offset (800 mV) from the actual EN/SS pin voltage to the voltage applied to the error amplifier.

The soft-start is done in a closed-loop fashion, meaning that the error amplifier controls the output voltage at all times during the soft-start period and the feedback loop is never open as occurs in duty cycle limit soft-start schemes. The error amplifier has two non-inverting inputs, one connected to the 600-mV reference voltage, and the other connected to the offset EN/SS pin voltage. The lower of these two voltages is what the error amplifier controls the FB pin. As the voltage on the EN/SS pin ramps up past approximately 1.4 V (800-mV offset voltage plus the 600 mV reference voltage), the 600-mV reference voltage becomes the dominant input and the converter has reached its final regulation voltage.

The capacitor required for a given soft-start ramp time for the output voltage is given by [Equation 1](#).

$$C_{SS} = \left(\frac{I_{SS}}{V_{FB}} \right) \times t_{SS}$$

where

- C_{SS} is the required capacitance on the EN/SS pin. (F)
- I_{SS} is the soft-start source current (10 μ A).
- V_{FB} is the feedback reference voltage (0.6 V).
- t_{SS} is the desired soft-start ramp time (s).

(1)

Feature Description (continued)

7.3.4 Oscillator and Frequency Spread Spectrum (FSS)

The oscillator frequency is internally fixed. The TPS40303 operating frequency is 300 kHz, the TPS40304 operating frequency is 600 kHz, and the TPS40305 operating frequency is 1.2 MHz.

Connecting a resistor with a value of 267 kΩ ±10% from BP to EN/SS enables the FSS feature. When the FSS is enabled, it spreads the internal oscillator frequency over a minimum 12% window using a 25-kHz modulation frequency with triangular profile. By modulating the switching frequency, side-bands are created. The emission power of the fundamental switching frequency and its harmonics is distributed into smaller pieces scattered around many sideband frequencies. The effect significantly reduces the peak EMI noise and makes it much easier for the resultant emission spectrum to pass EMI regulations.

7.3.5 Overcurrent Protection

Programmable OCP level at LDRV is from 6 mV to 150 mV at room temperature with 3000 ppm temperature coefficient to help compensate for changes in the low-side FET channel resistance as temperature increases. With a scale factor of 2, the actual trip point across the low-side FET is in the range of 12 mV to 300 mV. The accuracy of the internal current source is ±5%. Overall offset voltage, including the offset voltage of the internal comparator and the amplifier for scale factor of 2, is limited to ±8 mV.

Maximum clamp voltage at LDRV is 340 mV to avoid turning on the low-side FET during calibration and in a prebiased condition. The maximum clamp voltage is fixed and it does not change with temperature. If the voltage drop across R_{OCSET} reaches the 340-mV maximum clamp voltage during calibration (no R_{OCSET} resistor included), it disables OC protection. Once disabled, there is no low-side or high-side current sensing.

OCP level at HDRV is fixed at 450 mV with 3000-ppm temperature coefficient to help compensate for changes in the high-side FET channel resistance as temperature increases. OCP at HDRV provides pulse-by-pulse current limiting.

OCP sensing at LDRV is a true inductor valley current detection, using sample and hold. [Equation 2](#) can be used to calculate R_{OCSET}:

$$R_{OCSET} = \left(\frac{\left(I_{OUT(max)} - \left(\frac{I_{P-P}}{2} \right) \right) \times R_{DS(on)} - V_{OCLOS}}{2 \times I_{OCSET}} \right)$$

where

- I_{OCSET} is the internal current source.
- V_{OCLOS} is the overall offset voltage.
- I_{P-P} is the peak-to-peak inductor current.
- R_{DS(on)} is the drain to source ON-resistance of the low-side FET.
- I_{OUT(max)} is the trip point for OCP.
- R_{OCSET} is the resistor used for setting the OCP level. (2)

To avoid overcurrent tripping in normal operating load range, calculate R_{OCSET} using the equation above with:

- The maximum R_{DS(ON)} at room temperature
- The lower limit of V_{OCLOS} (–8 mV) and the lower limit of I_{OCSET} (9.5 μA) from the *Electrical Characteristics* table.
- The peak-to-peak inductor current I_{P-P} at minimum input voltage

Overcurrent is sensed across both the low-side FET and the high-side FET. If the voltage drop across either FET exceeds the OC threshold, a count increments one count. If no OC is detected on either FET, the fault counter decrements by one count. If three OC pulses are summed, a fault condition is declared which cycles the soft-start function in a hiccup mode. Hiccup mode consists of four dummy soft-start timeouts followed by a real one if overcurrent condition is encountered during normal operation, or five dummy soft-start timeouts followed by a real one if overcurrent condition occurs from the beginning during start. This cycle continues indefinitely until the fault condition is removed.

Feature Description (continued)

7.3.6 Drivers

The drivers for the external high-side and low-side MOSFETs can drive a gate-to-source voltage of V_{BP} . The LDRV driver for the low-side MOSFET switches between BP and GND, while the HDRV driver for the high-side MOSFET is referenced to SW and switches between BOOT and SW. The drivers have nonoverlapping timing that is governed by an adaptive delay circuit to minimize body diode conduction in the synchronous rectifier.

7.3.7 Prebias Start-Up

The TPS4030x contains a circuit to prevent current from being pulled from the output during start-up in the condition the output is prebiased. There are no PWM pulses until the internal soft-start voltage rises above the error amplifier input (FB pin), if the output is prebiased. Once the soft-start voltage exceeds the error amplifier input, the controller slowly initiates synchronous rectification by starting the synchronous rectifier with a narrow on time. The controller then increments that on time on a cycle-by-cycle basis until it coincides with the time dictated by $(1-D)$, where D is the duty cycle of the converter. This approach prevents the sinking of current from a prebiased output, and ensures the output voltage start-up and ramp to regulation is smooth and controlled.

7.3.8 Power Good

The TPS4030x provides an indication that output is good for the converter. This is an open-drain signal and pulls low when any condition exists that would indicate that the output of the supply might be out of regulation. These conditions include the following:

- V_{FB} is more than $\pm 12.5\%$ from nominal.
- Soft-start is active.
- A short-circuit condition has been detected.

NOTE

When there is no power to the device, PGOOD is not able to pull close to GND if an auxiliary supply is used for the power good indication. In this case, a built-in resistor connected from drain to gate on the PGOOD pulldown device makes the PGOOD pin look approximately like a diode to GND.

7.3.9 Thermal Shutdown

If the junction temperature of the device reaches the thermal shutdown limit of 145°C, the PWM and the oscillator are turned off and HDRV and LDRV are driven low. When the junction cools to the required level (125°C typical), the PWM initiates soft-start as during a normal power-up cycle.

7.4 Device Functional Modes

7.4.1 Modes of Operation

7.4.1.1 UVLO

In UVLO, VDD is less than UVLO_ON, the BP6 regulator is off, and the HDRV and LDRV are held low by internal passive discharge resistors.

7.4.1.2 Disable

Disable is forced by holding SS/EN below 0.4 V. In disable, the BP6 regulator is off, and both HDRV and LDRV are held low by passive discharge resistors.

7.4.1.3 Calibration

Each enable of the TPS4030X3/4/5 devices requires a calibration which lasts approximately 2 ms. During calibration the TPS40303/4/5 devices LDRV and HDRV are held off by their respective pulldown drivers while the device configures as detailed in [Enable Functionality](#), [Start-Up Sequence and Timing](#).

7.4.1.4 Converting

When calibration completes, the TPS40303/4/5 devices ramp their reference voltage as described in [Soft-Start Time](#), and the states of the LDRV and HDRV drivers are dictated by the COMP pin to regulate the FB pin equal to the internal reference.

8 Application and Implementation

NOTE

Information in the following applications sections is not part of the TI component specification, and TI does not warrant its accuracy or completeness. TI's customers are responsible for determining suitability of components for their purposes. Customers should validate and test their design implementation to confirm system functionality.

8.1 Application Information

The TPS4030x is a family of cost-optimized synchronous buck controllers providing high-end features to construct high-performance DC-DC converters. Prebias capability eliminates concerns about damaging sensitive loads during start-up. Programmable overcurrent protection levels and hiccup overcurrent fault recovery maximize design flexibility and minimize power dissipation in the event of a prolonged output short. Frequency Spread Spectrum (FSS) feature reduces peak EMI noise by spreading the initial energy of each harmonic along a frequency band, thus giving a wider spectrum with lower amplitudes.

8.2 Typical Applications

8.2.1 Using the TPS40305 for a 12-V to 1.8-V Point-of-Load Synchronous Buck Regulator

Figure 14 shows 12-V to 1.8-V at 10-A synchronous buck application using the TPS40305 switching at 1200 kHz.

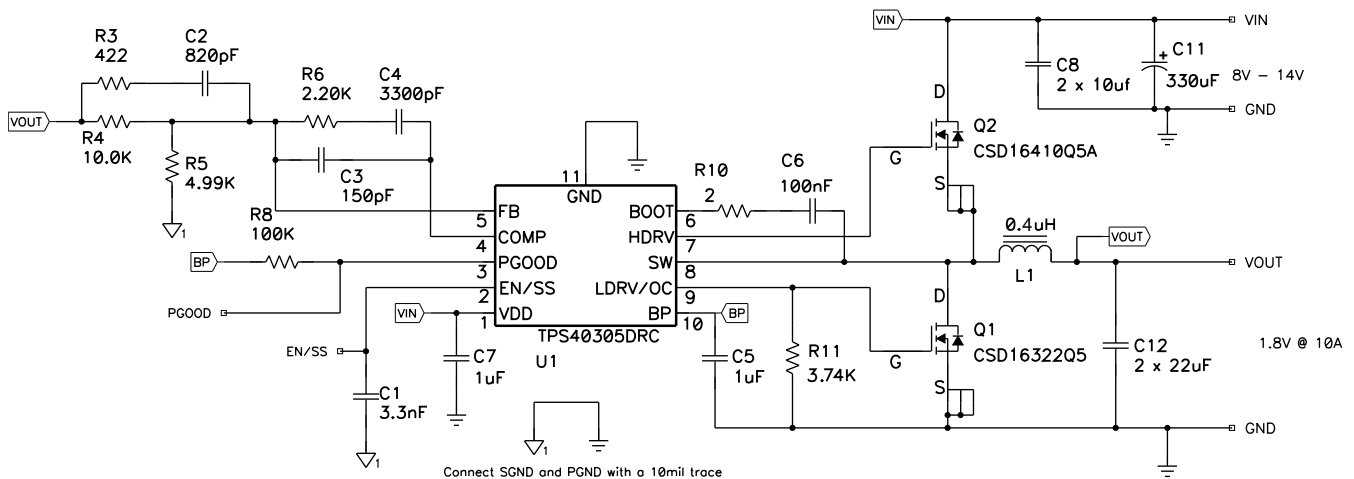

Copyright © 2017, Texas Instruments Incorporated

Figure 14. TPS40305 Design Example Schematic

Typical Applications (continued)

8.2.1.1 Design Requirements

For this example, follow the design parameters listed in [Table 1](#).

Table 1. Design Example Electrical Characteristics

PARAMETER		TEST CONDITIONS	MIN	TYP	MAX	UNIT
V_{IN}	Input voltage		8		14	V
$V_{IN(ripple)}$	Input ripple	$I_{OUT} = 10\text{ A}$			0.6	V
V_{OUT}	Output voltage	$0\text{ A} \leq I_{OUT} \leq 10\text{ A}$	1.764	1.800	1.836	V
	Line regulation	$8\text{ V} \leq V_{IN} \leq 14\text{ V}$			0.5%	
	Load regulation	$0\text{ A} \leq I_{OUT} \leq 10\text{ A}$			0.5%	
V_{RIPPLE}	Output ripple	$I_{OUT} = 10\text{ A}$			36	mV
V_{OVER}	Output overshoot	I_{OUT} falling from 7 A to 3 A		100		mV
V_{UNDER}	Output undershoot	I_{OUT} rising from 3 A to 7 A		100		mV
I_{OUT}	Output current	$4.5\text{ V} \leq V_{IN} \leq 5.5\text{ V}$	0		10	A
t_{SS}	Soft-start time	$V_{IN} = 12\text{ V}$		1.5		ms
I_{SCP}	Short-circuit current trip point		13	15		A
f_{SW}	Switching frequency			1200		kHz
	Size			1		in ²

The bill of materials for this application is shown in [Table 2](#). The efficiency, line, and load regulation from boards built using this design are shown in [Figure 14](#). Gerber files and additional application information are available from the factory.

Table 2. Design Example List of Materials

REFERENCE DESIGNATOR	QTY	VALUE	DESCRIPTION	SIZE	PART NUMBER	MFR
C1	1	3.3 nF	Capacitor, Ceramic, 10 V, X7R, 20%	0603	Std	Std
C2	1	820 pF	Capacitor, Ceramic, 25 V, X7R, 10%	0603	Std	Std
C3	1	150 pF	Capacitor, Ceramic, 25 V, X7R, 10%	0603	Std	Std
C4	1	3300 pF	Capacitor, Ceramic, 25 V, X7R, 10%	0603	Std	Std
C5	1	1.0 μ F	Capacitor, Ceramic, 10 V, X7R, 20%	0805	Std	Std
C6	1	100 nF	Capacitor, Ceramic, 16 V, X7R, 20%	0603	Std	Std
C7	1	1 μ F	Capacitor, Ceramic, 25 V, X7R, 20%	0805	Std	Std
C8	2	10 μ f	Capacitor, Ceramic, 25 V, X7R, 10%	1210	Std	Std
C11	1	330 μ F	Capacitor, Aluminum, 25 V, \pm 20%, 160 m Ω	0.328 x 0.390 inch	EEVFK1E331P	Panasonic
C12	2	22 μ F	Capacitor, Ceramic, 6.3 V, X5R, 20%	0805	Std	Std
L1	1	0.32 μ H	Inductor, SMT, 17 A	0.268 x 0.268 inch	PG0083.401	Pulse
Q1	1		MOSFET, N-Channel, 25 V, 97 A, 4.6 m Ω	QFN-8 POWER	CSD16322Q5	TI
Q2	1		MOSFET, N-Channel, 25 V, 59 A, 9.6 m Ω	QFN-8 POWER	CSD16410Q5A	TI
R3	1	422 Ω	Resistor, Chip, 1/16W, 1%	0603	Std	Std
R4	1	10.0 k Ω	Resistor, Chip, 1/16W, 1%	0603	Std	Std
R5	1	4.99 k Ω	Resistor, Chip, 1/16W, 1%	0603	Std	Std
R6	1	2.20 k Ω	Resistor, Chip, 1/16W, 1%	0603	Std	Std
R8	1	100 k Ω	Resistor, Chip, 1/16W, 1%	0603	Std	Std
R10	1	2 Ω	Resistor, Chip, 1/16W, 1%	0603	Std	Std
R11	1	3.74 k Ω	Resistor, Chip, 1/16W, 1%	0603	Std	Std
U1	1		IC, 3-V to 20-V sync. 1.2-MHz Buck controller	DRC10	TPS40305DRC	TI

8.2.1.2 Detailed Design Procedure

8.2.1.2.1 Custom Design With WEBENCH® Tools

[Click here](#) to create a custom design using the TPS4030x device with the WEBENCH® Power Designer.

1. Start by entering the input voltage (V_{IN}), output voltage (V_{OUT}), and output current (I_{OUT}) requirements.
2. Optimize the design for key parameters such as efficiency, footprint, and cost using the optimizer dial.
3. Compare the generated design with other possible solutions from Texas Instruments.

The WEBENCH Power Designer provides a customized schematic along with a list of materials with real-time pricing and component availability.

In most cases, these actions are available:

- Run electrical simulations to see important waveforms and circuit performance
- Run thermal simulations to understand board thermal performance
- Export customized schematic and layout into popular CAD formats
- Print PDF reports for the design, and share the design with colleagues

Get more information about WEBENCH tools at www.ti.com/WEBENCH.

8.2.1.2.2 Selecting the Switching Frequency

To achieve the small size for this design, the TPS40305, with $f_{SW} = 1200$ kHz, is selected for minimal external component size.

8.2.1.2.3 Inductor Selection (L1)

Synchronous buck power inductors are typically sized for approximately 30% peak-to-peak ripple current (I_{RIPPLE})

Given this target ripple current, the required inductor size can be calculated in [Equation 3](#).

$$L \approx \frac{V_{IN(max)} - V_{OUT}}{0.3 \times I_{OUT}} \times \frac{V_{OUT}}{V_{IN(max)}} \times \frac{1}{f_{SW}} = \frac{14\text{ V} - 1.8\text{ V}}{0.3 \times 10\text{ A}} \times \frac{1.8\text{ V}}{14\text{ V}} \times \frac{1}{1200\text{ kHz}} = 471\text{ nH} \quad (3)$$

Selecting a standard 400-nH inductor value, solve for $I_{RIPPLE} = 3.5$ A

The RMS current through the inductor is approximated by [Equation 4](#).

$$I_{L(rms)} = \sqrt{I_{L(avg)}^2 + \frac{1}{12} I_{RIPPLE}^2} = \sqrt{I_{OUT}^2 + \frac{1}{12} I_{RIPPLE}^2} = \sqrt{10^2 + \frac{1}{12} 3.5^2} = 10.05\text{ A} \quad (4)$$

8.2.1.2.4 Output Capacitor Selection (C12)

The selection of the output capacitor is typically driven by the output transient response. [Equation 5](#) and [Equation 6](#) overestimate the voltage deviation to account for delays in the loop bandwidth and can be used to determine the required output capacitance.

$$V_{OVER} < \frac{I_{TRAN}}{C_{OUT}} \times \Delta T = \frac{I_{TRAN}}{C_{OUT}} \times \frac{I_{TRAN} \times L}{V_{OUT}} = \frac{I_{TRAN}^2 \times L}{V_{OUT} \times C_{OUT}} \quad (5)$$

$$V_{UNDER} < \frac{I_{TRAN}}{C_{OUT}} \times \Delta T = \frac{I_{TRAN}}{C_{OUT}} \times \frac{I_{TRAN} \times L}{V_{IN} - V_{OUT}} = \frac{I_{TRAN}^2 \times L}{(V_{IN} - V_{OUT}) \times C_{OUT}} \quad (6)$$

If $V_{IN(min)} > 2 \times V_{OUT}$, use overshoot ([Equation 5](#)) to calculate minimum output capacitance. If $V_{IN(min)} < 2 \times V_{OUT}$, use undershoot ([Equation 6](#)) to calculate minimum output capacitance.

$$C_{OUT(min)} = \frac{I_{TRAN(max)}^2 \times L}{(V_{OUT}) \times V_{OVER}} = \frac{4^2 \times 400\text{ nH}}{1.8 \times 100\text{ mV}} = 35\text{ }\mu\text{F} \quad (7)$$

With a minimum capacitance, the maximum allowable ESR is determined by the maximum ripple voltage and is approximated by [Equation 8](#).

$$ESR_{MAX} = \frac{V_{RIPPLE(total)} - V_{RIPPLE(cap)}}{I_{RIPPLE}} = \frac{V_{RIPPLE(total)} - \left(\frac{I_{RIPPLE}}{8 \times C_{OUT} \times f_{SW}} \right)}{I_{RIPPLE}}$$

$$= \frac{36\text{mV} - \left(\frac{3.5\text{A}}{8 \times 35\mu\text{F} \times 1200\text{kHz}} \right)}{3.5\text{A}} = 7\text{m}\Omega \quad (8)$$

Two 0805, 22- μF , 6.3-V, X5R ceramic capacitors are selected to provide more than 35 μF of minimum capacitance and less than 7 m Ω of ESR (2.5 m Ω each).

8.2.1.2.5 Peak Current Rating of Inductor

With output capacitance, it is possible to calculate the charge current during start-up and determine the minimum saturation current rating for the inductor. The start-up charging current is approximated by [Equation 9](#).

$$I_{CHARGE} = \frac{V_{OUT} \times C_{OUT}}{t_{SS}} = \frac{1.8\text{V} \times 2 \times 22\mu\text{F}}{1.5\text{ms}} = 0.053\text{A} \quad (9)$$

$$I_{L(peak)} = I_{OUT(max)} + \frac{1}{2}I_{RIPPLE} + I_{CHARGE} = 10\text{A} + \frac{1}{2} \times 3.5\text{A} + 0.053\text{A} = 11.8\text{A} \quad (10)$$

Table 3. Inductor Requirements

SYMBOL	PARAMETER	VALUE	UNIT
L	Inductance	400	nH
$I_{L(rms)}$	RMS current (thermal rating)	10.05	A
$I_{L(peak)}$	Peak current (saturation rating)	11.8	A

A PG0083.401, 400-nH inductor is selected for its small size, low DCR (3.0 m Ω) and high-current handling capability (17-A thermal, 27-A saturation).

8.2.1.2.6 Input Capacitor Selection (C8)

The input voltage ripple is divided between capacitance and ESR. For this design $V_{RIPPLE(cap)} = 150\text{mV}$ and $V_{RIPPLE(esr)} = 150\text{mV}$. The minimum capacitance and maximum ESR are estimated by [Equation 11](#).

$$C_{IN(min)} = \frac{I_{LOAD} \times V_{OUT}}{V_{RIPPLE(cap)} \times V_{IN} \times f_{SW}} = \frac{10 \times 1.8\text{V}}{150\text{mV} \times 8\text{V} \times 1200\text{kHz}} = 12.5\mu\text{F} \quad (11)$$

$$ESR_{MAX} = \frac{V_{RIPPLE(esr)}}{I_{LOAD} + \frac{1}{2}I_{RIPPLE}} = \frac{150\text{mV}}{11.75\text{A}} = 12.7\text{m}\Omega \quad (12)$$

The RMS current in the input capacitors is estimated by [Equation 13](#).

$$I_{RMS(cin)} = I_{LOAD} \times \sqrt{D \times (1 - D)} = 10\text{A} \times \sqrt{0.225 \times (1 - 0.225)} = 4.17\text{A}_{RMS} \quad (13)$$

Two 1210, 10- μF , 25-V, X5R ceramic capacitors with approximately 2-m Ω of ESR and a 2.5-A RMS current rating each are selected. Higher voltage capacitors are selected to minimize capacitance loss at the DC bias voltage to ensure the capacitors allow sufficient capacitance at the working voltage.

8.2.1.2.7 MOSFET Switch Selection (Q1 and Q2)

Reviewing available TI NexFET MOSFETs using TI's NexFET MOSFET selection tool, the CSD16410Q5A and CSD16322Q5 5-mm \times 6-mm MOSFETs are selected.

These two FETs have maximum total gate charges of 5 nC and 10 nC, respectively, which draws 18 mA at 1.2 MHz from the BP regulator, less than its 50 mA minimum rating.

8.2.1.2.8 Bootstrap Capacitor (C6)

To ensure proper charging of the high-side FET gate, limit the ripple voltage on the boost capacitor to less than 50 mV.

$$C_{\text{BOOST}} = 20 \times Q_{G2} = 20 \times 5 \text{ nC} = 100 \text{ nF} \quad (14)$$

8.2.1.2.9 VDD Bypass Capacitor (C7)

Per the TPS40305 [Electrical Characteristics](#) specifications, select a 1.0- μF X5R or better ceramic bypass capacitor for VDD.

8.2.1.2.10 BP Bypass Capacitor (C5)

As listed in the [Electrical Characteristics](#), a minimum of 1.0- μF ceramic capacitance is required to stabilize the BP regulator. To limit regulator noise to less than 10 mV, the value of the bypass capacitor is calculated in [Equation 15](#).

$$C_{\text{BP}} = 100 \times \text{MAX}(Q_{G1}, Q_{G2}) \quad (15)$$

Because Q1 is larger than Q2, and the total gate charge of Q1 is 10 nC, a BP capacitor of 1.0 μF is calculated. A standard value of 1.0 μF is selected to limit noise on the BP regulator.

8.2.1.2.11 Short-Circuit Protection (R11)

The TPS40305 uses the negative drop across the low-side FET at the end of the OFF time to measure the inductor current. Allowing for 30% over maximum load and 20% rise in $R_{\text{DS(on)Q1}}$ for self-heating, the voltage drop across the low-side FET at current limit is given by [Equation 16](#).

$$V_{\text{OC}} = (1.3 \times I_{\text{LOAD}} - \frac{1}{2} I_{\text{RIPPLE}}) \times 1.2 \times R_{\text{DS(on)Q1}} = (1.3 \times 10 \text{ A} - \frac{1}{2} \times 3.5 \text{ A}) \times 1.2 \times 4.6 \text{ m}\Omega = 62.1 \text{ mV} \quad (16)$$

The TPS40305 internal temperature coefficient helps compensate for the $R_{\text{DS(on)}}$ temperature coefficient of the MOSFET, so the current limit programming resistor is selected by [Equation 17](#).

$$R_{\text{CS}} = \frac{V_{\text{OC}} - V_{\text{OCLOS(min)}}}{2 \times I_{\text{OCSET(min)}}} = \frac{62.1 \text{ mV} - (-8 \text{ mV})}{2 \times 9.5 \text{ mA}} = 3.69 \text{ k}\Omega \approx 3.74 \text{ k}\Omega \quad (17)$$

8.2.1.2.12 Feedback Divider (R4, R5)

The TPS40305 controller uses a full operational amplifier with an internally fixed 0.600-V reference. R4 is selected between 10 k Ω and 50 k Ω for a balance of feedback current and noise immunity. With R4 set to 10 k Ω , The output voltage is programmed with a resistor divider given by [Equation 18](#).

$$R5 = \frac{V_{\text{FB}} \times R4}{V_{\text{OUT}} - V_{\text{FB}}} = \frac{0.600 \text{ V} \times 10.0 \text{ k}\Omega}{1.8 \text{ V} - 0.600 \text{ V}} = 5.0 \text{ k}\Omega \approx 4.99 \text{ k}\Omega \quad (18)$$

8.2.1.2.13 Compensation: (C2, C3, C4, R3, R6)

Using the TPS40k Loop Stability Tool for 100-kHz bandwidth and 60° phase margin with a R4 value of 10.0 k Ω , the following values are returned.

- C2 = C_1 = 820 pF
- C3 = C_3 = 150 pF
- C4 = C_2 = 3300 pF
- R3 = R_2 = 422 Ω
- R6 = R_3 = 2.20 k Ω

8.2.1.3 Application Curves

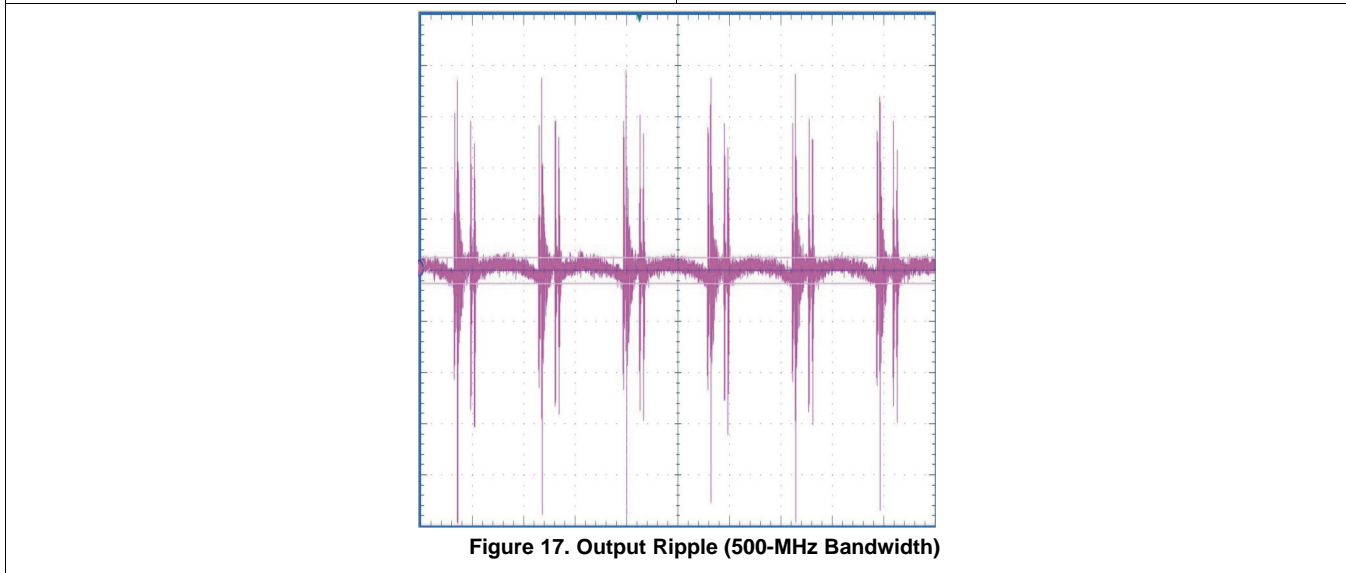
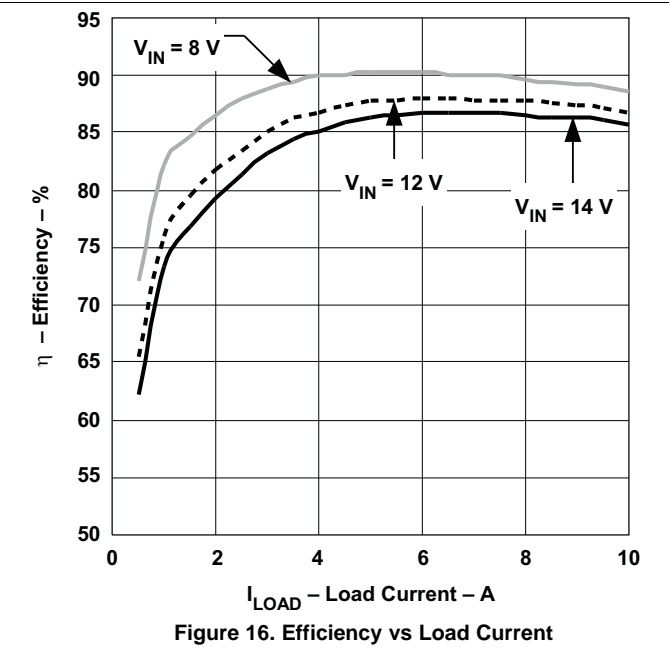
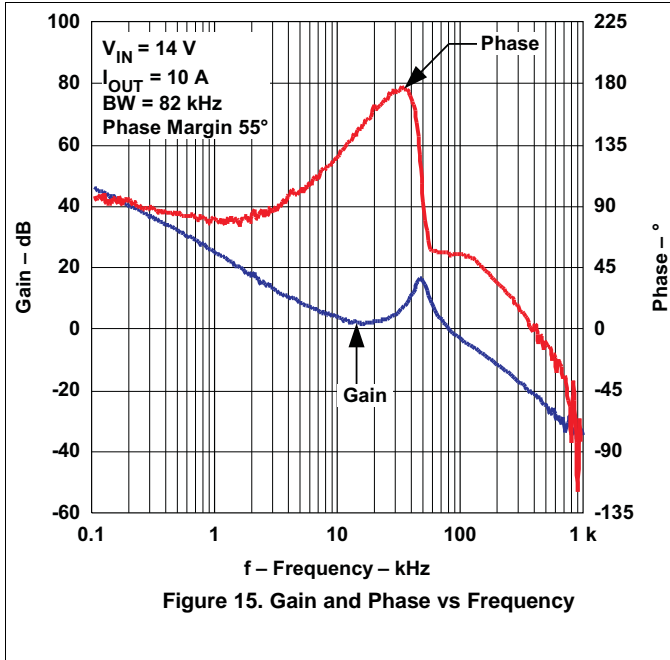

8.2.2 A High-Current, Low-Voltage Design Using the TPS40304

For this 20-A, 12-V to 1.2-V design, the 600-kHz TPS40304 was selected for a balance between small size and high efficiency.

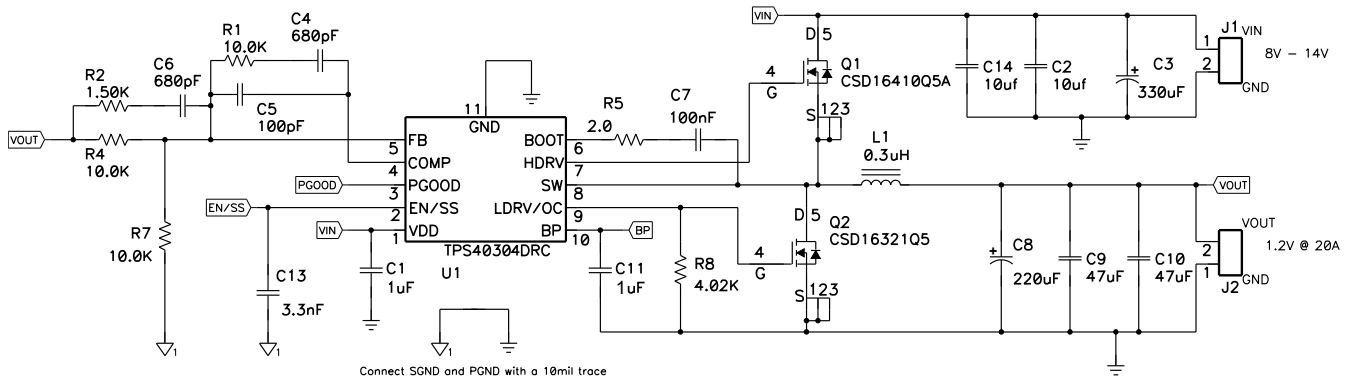

Copyright © 2017, Texas Instruments Incorporated

Figure 18. TPS40304 Design Example Schematic

8.2.2.1 Design Requirements

For this example, follow the design parameters listed in [Table 4](#).

Table 4. Design Example Electrical Characteristics

PARAMETER		TEST CONDITIONS	MIN	TYP	MAX	UNIT
V_{IN}	Input voltage		8		14	V
$V_{INRIPPLE}$	Input ripple	$I_{OUT} = 20\text{ A}$			0.5	V
V_{OUT}	Output voltage	$0\text{ A} \leq I_{OUT} \leq 20\text{ A}$	1.164	1.200	1.236	V
	Line regulation	$8\text{ V} \leq V_{IN} \leq 14\text{ V}$			0.5%	
	Load regulation	$0\text{ A} \leq I_{OUT} \leq 20\text{ A}$			0.5%	
V_{RIPPLE}	Output ripple	$I_{OUT} = 20\text{ A}$			36	mV
V_{OVER}	Output overshoot	$5\text{ A} \leq I_{OUT} \leq 15\text{ A}$		100		mV
V_{UNDER}	Output undershoot	$5\text{ A} \leq I_{OUT} \leq 15\text{ A}$		100		mV
I_{OUT}	Output current	$8\text{ V} \leq V_{IN} \leq 14\text{ V}$	0		20	A
t_{SS}	Soft-start time	$V_{IN} = 12\text{ V}$		1.5		ms
I_{SCP}	Short-circuit current trip point		26			A
f_{SW}	Switching frequency			600		kHz
	Size				1.5	in ²

8.2.2.2 Detailed Design Procedure

8.2.2.2.1 Selecting the Switching Frequency

To achieve the small size for this design the TPS40304, with $f_{SW} = 600\text{ kHz}$, is selected for minimal external component size.

8.2.2.2.2 Inductor Selection (L1)

Synchronous buck power inductors are typically sized for approximately 30% peak-to-peak ripple current (I_{RIPPLE})

Given this target ripple current, the required inductor size can be calculated in [Equation 19](#).

$$L \approx \frac{V_{IN(max)} - V_{OUT}}{0.3 \times I_{OUT}} \times \frac{V_{OUT}}{V_{IN(max)}} \times \frac{1}{F_{SW}} = \frac{14\text{V} - 1.2\text{V}}{0.3 \times 20\text{A}} \times \frac{1.2\text{V}}{14\text{V}} \times \frac{1}{600\text{kHz}} = 305\text{nH} \quad (19)$$

Selecting a standard 300-nH inductor value, solve for $I_{RIPPLE} = 6\text{ A}$

The RMS current through the inductor is approximated by [Equation 20](#).

$$I_{L_{rms}} = \sqrt{I_{L_{avg}}^2 + \frac{1}{12} I_{RIPPLE}^2} = \sqrt{I_{OUT}^2 + \frac{1}{12} I_{RIPPLE}^2} = \sqrt{20^2 + \frac{1}{12} 6^2} = 20.07 \text{ A} \quad (20)$$

8.2.2.2.3 Output Capacitor Selection (C12)

The selection of the output capacitor is typically driven by the output transient response. [Equation 21](#) and [Equation 22](#) overestimate the voltage deviation to account for delays in the loop bandwidth and can be used to determine the required output capacitance.

$$V_{OVER} < \frac{I_{TRAN}}{C_{OUT}} \times \Delta T = \frac{I_{TRAN}}{C_{OUT}} \times \frac{I_{TRAN} \times L}{V_{OUT}} = \frac{I_{TRAN}^2 \times L}{V_{OUT} \times C_{OUT}} \quad (21)$$

$$V_{UNDER} < \frac{I_{TRAN}}{C_{OUT}} \times \Delta T = \frac{I_{TRAN}}{C_{OUT}} \times \frac{I_{TRAN} \times L}{V_{IN} - V_{OUT}} = \frac{I_{TRAN}^2 \times L}{(V_{IN} - V_{OUT}) \times C_{OUT}} \quad (22)$$

If $V_{IN(min)} > 2 \times V_{OUT}$, use overshoot ([Equation 21](#)) to calculate minimum output capacitance. If $V_{IN(min)} < 2 \times V_{OUT}$, use undershoot ([Equation 22](#)) to calculate minimum output capacitance.

$$C_{OUT(MIN)} = \frac{I_{TRAN(MAX)}^2 \times L}{(V_{OUT}) \times V_{OVER}} = \frac{10^2 \times 300\text{nH}}{1.2 \times 100\text{mV}} = 250\mu\text{F} \quad (23)$$

With a minimum capacitance, the maximum allowable ESR is determined by the maximum ripple voltage and is approximated by [Equation 24](#).

$$ESR_{max} = \frac{V_{RIPPLE(Total)} - V_{RIPPLE(CAP)}}{I_{RIPPLE}} = \frac{V_{RIPPLE(total)} - \left(\frac{I_{RIPPLE}}{8 \times C_{OUT} \times F_{SW}} \right)}{I_{RIPPLE}} = \frac{36\text{mV} - \left(\frac{6\text{A}}{8 \times 250\mu\text{F} \times 600\text{kHz}} \right)}{6\text{A}} = 5.2\text{m}\Omega \quad (24)$$

Two 47- μF and one 220- μF capacitors are selected to provide more than 250 μF of minimum capacitance and 5.2 $\text{m}\Omega$ of ESR.

8.2.2.2.4 Peak Current Rating of Inductor

With output capacitance, it is possible to calculate the charge current during start-up and determine the minimum saturation current rating for the inductor. The start-up charging current is approximated by [Equation 25](#).

$$I_{CHARGE} = \frac{V_{OUT} \times C_{OUT}}{T_{SS}} = \frac{1.2 \text{ V}(2 \times 47 \mu\text{F} + 220 \mu\text{F})}{1.5 \text{ ms}} = 0.251 \text{ A} \quad (25)$$

$$I_{L_PEAK} = I_{OUT(max)} + \frac{1}{2} I_{RIPPLE} + I_{CHARGE} = 20 \text{ A} + \frac{1}{2} \times 6 \text{ A} + 0.2512 \text{ A} = 23.25 \text{ A} \quad (26)$$

Table 5. Inductor Requirements

PARAMETER		VALUE	UNIT
L	Inductance	300	nH
$I_{L(rms)}$	RMS current (thermal rating)	20.07	A
$I_{L(peak)}$	Peak current (saturation rating)	23.25	A

8.2.2.2.5 Input Capacitor Selection (C8)

The input voltage ripple is divided between capacitance and ESR. For this design $V_{\text{RIPPLE}(\text{cap})} = 150 \text{ mV}$ and $V_{\text{RIPPLE}(\text{esr})} = 150 \text{ mV}$. The minimum capacitance and maximum ESR are estimated by [Equation 27](#).

$$C_{\text{IN}(\text{min})} = \frac{I_{\text{LOAD}} \times V_{\text{OUT}}}{V_{\text{RIPPLE}(\text{CAP})} \times V_{\text{IN}} \times F_{\text{SW}}} = \frac{20 \times 1.2\text{V}}{150\text{mV} \times 8\text{V} \times 600\text{kHz}} = 33.3\mu\text{F} \quad (27)$$

$$\text{ESR}_{\text{MAX}} = \frac{V_{\text{RIPPLE}(\text{ESR})}}{I_{\text{LOAD}} + \frac{1}{2}I_{\text{RIPPLE}}} = \frac{150 \text{ mV}}{23\text{A}} = 6.5 \text{ m}\Omega \quad (28)$$

The RMS current in the input capacitors is estimated by [Equation 29](#).

$$I_{\text{RMS_CIN}} = I_{\text{LOAD}} \times \sqrt{D \times (1-D)} = 20 \text{ A} \times \sqrt{0.15 \times (1-0.15)} = 7.14 \text{ Arms} \quad (29)$$

Three 1210, 10- μF , 25-V, X5R ceramic capacitors are selected. Higher voltage capacitors are selected to minimize capacitance loss at the DC bias voltage to ensure the capacitors allow sufficient capacitance at the working voltage.

8.2.2.2.6 MOSFET Switch Selection (Q1 and Q2)

Reviewing available TI NexFET MOSFETs using the TI NexFET MOSFET selection tool, the CSD16410Q5A and CSD16321Q5 5-mm \times 6-mm MOSFETs are selected.

These two FETs have maximum total gate charges of 5 nC and 10 nC, respectively.

8.2.2.2.7 Bootstrap Capacitor (C6)

To ensure proper charging of the high-side FET gate, limit the ripple voltage on the boost capacitor to less than 50 mV.

$$C_{\text{Boost}} = 20 \times Q_{\text{G1}} = 20 \times 5 \text{ nC} = 100 \text{ nF} \quad (30)$$

8.2.2.2.8 VDD Bypass Capacitor (C7)

Per the TPS40304 data sheet, select a 1.0- μF X5R or better ceramic bypass capacitor for VDD.

8.2.2.2.9 BP Bypass Capacitor (C5)

Per the TPS40304 data sheet, a minimum 1.0- μF ceramic capacitance is required to stabilize the BP regulator. To limit regulator noise to less than 10 mV, the value of the bypass capacitor is calculated in [Equation 31](#).

$$C_{\text{BP}} = 100 \times \text{MAX}(Q_{\text{G1}}, Q_{\text{G2}}) \quad (31)$$

Because Q2 is larger than Q1, and the total gate charge of Q2 is 10 nC, a BP capacitor of 1.0 μF is calculated. A standard value of 1.0 μF is selected to limit noise on the BP regulator.

8.2.2.2.10 Short-Circuit Protection (R11)

The TPS40304 uses the negative drop across the low-side FET at the end of the OFF time to measure the inductor current. Allowing for 30% over maximum load and 20% rise in $R_{\text{DS}(\text{on})\text{Q1}}$ for self-heating, the voltage drop across the low-side FET at current limit is given by [Equation 32](#).

$$V_{\text{OC}} = (1.3 \times I_{\text{LOAD}} - \frac{1}{2}I_{\text{ripple}}) \times 1.2 \times R_{\text{DS}(\text{on})\text{Q2}} = (1.3 \times 20 \text{ A} - \frac{1}{2} 6 \text{ A}) \times 1.2 \times 4.6 \text{ m}\Omega = 127 \text{ mV} \quad (32)$$

The TPS40304 internal temperature coefficient helps compensate for the MOSFET $R_{\text{DS}(\text{on})}$ temperature coefficient, so the current limit programming resistor is selected by [Equation 33](#).

$$R_{\text{CS}} = \frac{V_{\text{OC}} - V_{\text{OCL}(\text{min})}}{2 \times I_{\text{OCSET}(\text{min})}} = \frac{127 \text{ mV} - (-8 \text{ mV})}{2 \times 9.5 \mu\text{A}} = 7.1 \text{ k}\Omega \quad (33)$$

8.2.2.2.11 Feedback Divider (R4, R5)

The TPS40304 controller uses a full operational amplifier with an internally fixed 0.6-V reference. R4 is selected between 10 kΩ and 50 kΩ for a balance of feedback current and noise immunity. With R4 set to 10 kΩ, The output voltage is programmed with a resistor divider given by [Equation 34](#).

$$R7 = \frac{V_{FB} \times R4}{V_{OUT} - V_{FB}} = \frac{0.600 \text{ V} \times 10.0 \text{ k}\Omega}{1.2 \text{ V} - 0.600 \text{ V}} = 10 \text{ k}\Omega \quad (34)$$

8.2.2.2.12 Compensation: (C2, C3, C4, R3, R6)

Using the TPS40k Loop Stability Tool for 100-kHz bandwidth and 60° phase margin with a R4 value of 10.0 kΩ, the following values are returned.

- C4 = 680 pF
- C5 = 100 pF
- C6 = 680 pF
- R1 = 10 kΩ
- R2 = 1.5 kΩ

8.2.2.3 Application Curves

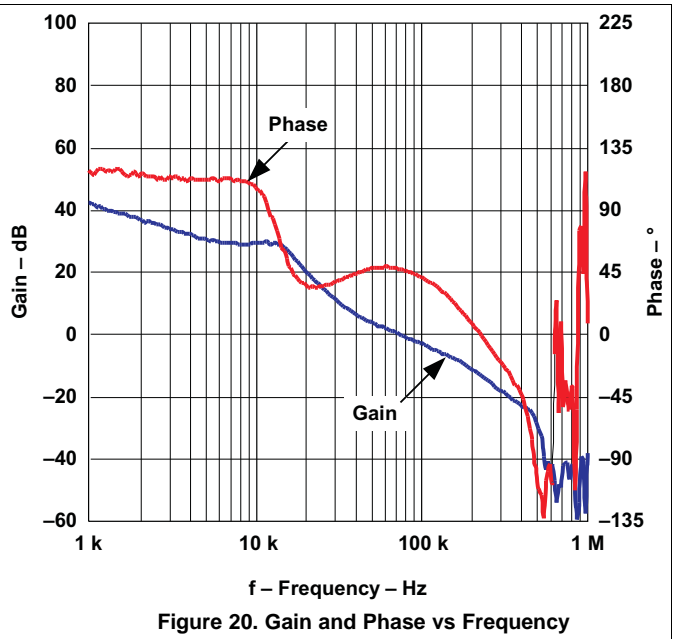
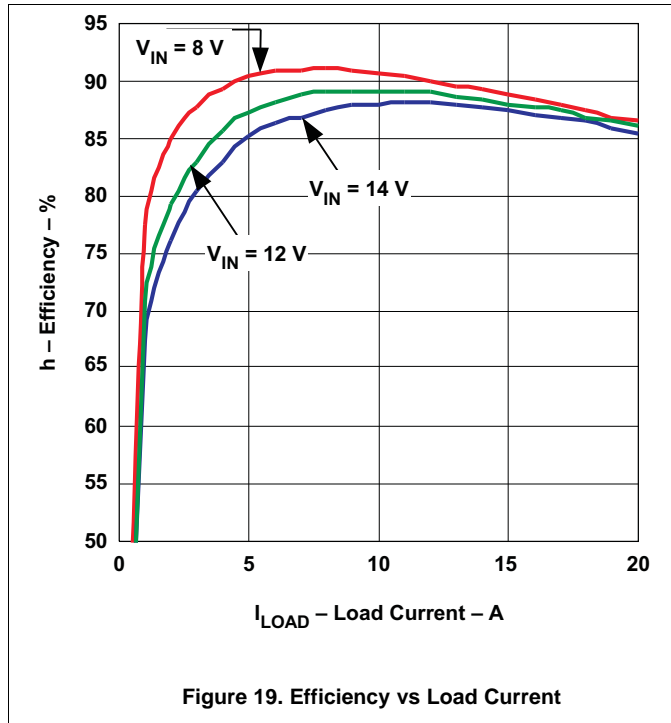

8.2.3 A Synchronous Buck Application Using the TPS40303

Figure 22 shows a 3.3-V/5-V/12-V to 0.6-V at 10-A synchronous buck application using the TPS40303 switching at 300 kHz.

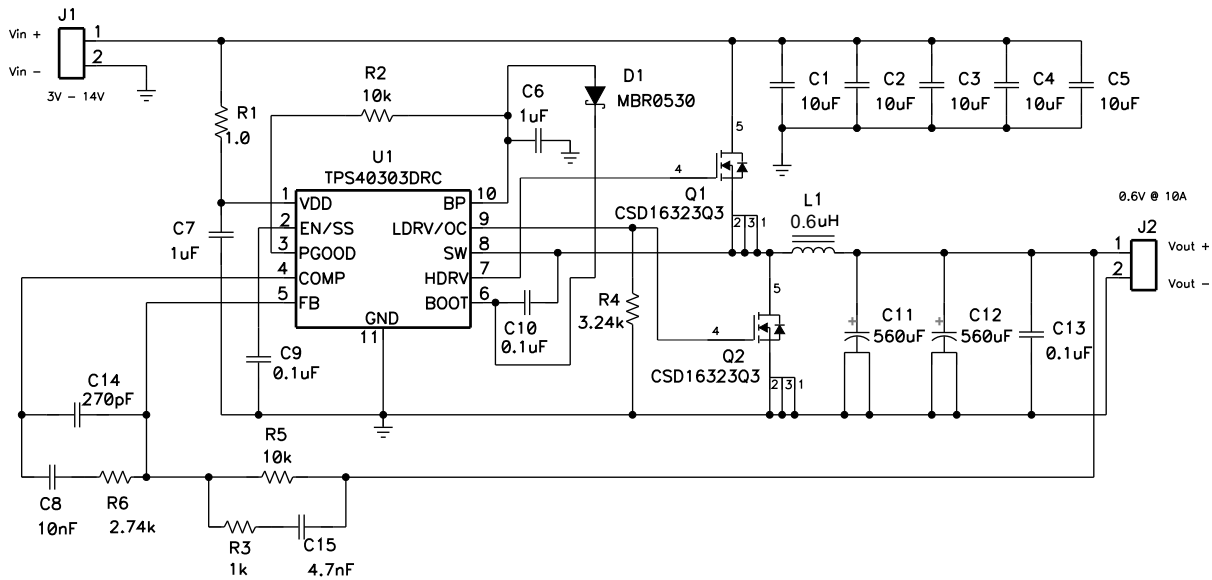

Copyright © 2017, Texas Instruments Incorporated

Figure 22. TPS40303 Design Example Schematic

8.2.3.1 Design Requirements

For this example, follow the design parameters listed in Table 6.

Table 6. Design Example Electrical Characteristics

PARAMETER	TEST CONDITIONS	MIN	TYP	MAX	UNIT	
V_{IN}	Input voltage	3.3		14	V	
$V_{INripple}$	Input ripple			0.6	V	
V_{OUT}	Output voltage	0 A $\leq I_{OUT} \leq$ 10 A	0.582	0.6	0.618	V
	Line regulation			0.5%		
	Load regulation			0.5%		
V_{RIPPLE}	Output ripple			12	mV	
V_{OVER}	Output overshoot		100		mV	
V_{UNDER}	Output undershoot		100		mV	
I_{OUT}	Output current		0	10	A	
t_{SS}	Soft-start time		1.5		ms	
I_{SCP}	Short-circuit current trip point		13	15	A	
	Efficiency		84%			
f_{SW}	Switching frequency		300		kHz	
	Size			1.5	in ²	

8.2.3.2 Detailed Design Procedure

8.2.3.2.1 Selecting the Switching Frequency

To achieve the small size for this design the TPS40303, with $f_{SW} = 300$ kHz, is selected for minimal external component size.

8.2.3.2.2 Inductor Selection (L1)

Synchronous buck power inductors are typically sized for approximately 30% peak-to-peak ripple current (I_{RIPPLE}). Given this target ripple current, the required inductor size can be calculated in [Equation 35](#).

$$L \approx \frac{V_{IN(max)} - V_{OUT}}{0.3 \times I_{OUT}} \times \frac{V_{OUT}}{V_{IN(max)}} \times \frac{1}{F_{SW}} = \frac{14V - 0.6V}{0.3 \times 10A} \times \frac{0.6V}{14V} \times \frac{1}{300kHz} = 638nH \quad (35)$$

Selecting a standard 600-nH inductor value, solve for $I_{RIPPLE} = 3.2$ A

The RMS current through the inductor is approximated by [Equation 36](#).

$$I_{Lrms} = \sqrt{I_{Lavg}^2 + \frac{1}{12} I_{RIPPLE}^2} = \sqrt{I_{OUT}^2 + \frac{1}{12} I_{RIPPLE}^2} = \sqrt{10^2 + \frac{1}{12} 3.2^2} = 10.04A \quad (36)$$

8.2.3.2.3 Output Capacitor Selection (C12)

The selection of the output capacitor is typically driven by the output transient response. [Equation 37](#) and [Equation 38](#) overestimate the voltage deviation to account for delays in the loop bandwidth and can be used to determine the required output capacitance.

$$V_{OVER} < \frac{I_{TRAN}}{C_{OUT}} \times \Delta T = \frac{I_{TRAN}}{C_{OUT}} \times \frac{I_{TRAN} \times L}{V_{OUT}} = \frac{I_{TRAN}^2 \times L}{V_{OUT} \times C_{OUT}} \quad (37)$$

$$V_{UNDER} < \frac{I_{TRAN}}{C_{OUT}} \times \Delta T = \frac{I_{TRAN}}{C_{OUT}} \times \frac{I_{TRAN} \times L}{V_{IN} - V_{OUT}} = \frac{I_{TRAN}^2 \times L}{(V_{IN} - V_{OUT}) \times C_{OUT}} \quad (38)$$

If $V_{IN(min)} > 2 \times V_{OUT}$, use overshoot ([Equation 37](#)) to calculate minimum output capacitance. If $V_{IN(min)} < 2 \times V_{OUT}$, use undershoot ([Equation 38](#)) to calculate minimum output capacitance.

$$C_{OUT(MIN)} = \frac{I_{TRAN(MAX)}^2 \times L}{(V_{OUT}) \times V_{OVER}} = \frac{4^2 \times 600 \text{ nH}}{0.6 \times 100 \text{ mV}} = 160 \mu F \quad (39)$$

With a minimum capacitance, the maximum allowable ESR is determined by the maximum ripple voltage and is approximated by [Equation 40](#).

$$ESR_{max} = \frac{V_{RIPPLE(Total)} - V_{RIPPLE(CAP)}}{I_{RIPPLE}} = \frac{V_{RIPPLE(total)} - \left(\frac{I_{RIPPLE}}{8 \times C_{OUT} \times F_{SW}} \right)}{I_{RIPPLE}} = \frac{36 \text{ mV} - \left(\frac{3.2 \text{ A}}{8 \times 160 \mu F \times 300 \text{ kHz}} \right)}{3.2 \text{ A}} = 8.6 \text{ m}\Omega \quad (40)$$

Two 560- μ F capacitors are selected to provide more than 160- μ F of minimum capacitance and less than 8.6 m Ω of ESR.

8.2.3.2.4 Peak Current Rating of Inductor

With output capacitance, it is possible to calculate the charge current during start-up and determine the minimum saturation current rating for the inductor. The start-up charging current is approximated by [Equation 41](#).

$$I_{\text{CHARGE}} = \frac{V_{\text{OUT}} \times C_{\text{OUT}}}{T_{\text{SS}}} = \frac{0.6 \text{ V}(2 \times 560 \mu\text{F})}{1.5 \text{ ms}} = 0.448 \text{ A} \quad (41)$$

$$I_{\text{L_PEAK}} = I_{\text{OUT(max)}} + \frac{1}{2}I_{\text{RIPPLE}} + I_{\text{CHARGE}} = 10\text{A} + \frac{1}{2} \times 3.2\text{A} + 0.448\text{A} = 12.05\text{A} \quad (42)$$

Table 7. Inductor Requirements

PARAMETER		VALUE	UNIT
L	Inductance	600	nH
$I_{\text{L(rms)}}$	RMS current (thermal rating)	10.04	A
$I_{\text{L(peak)}}$	Peak current (saturation rating)	12.05	A

8.2.3.2.5 Input Capacitor Selection (C8)

The input voltage ripple is divided between capacitance and ESR. For this design $V_{\text{RIPPLE(cap)}} = 150 \text{ mV}$ and $V_{\text{RIPPLE(esr)}} = 150 \text{ mV}$. The minimum capacitance and maximum ESR are estimated by [Equation 43](#).

$$C_{\text{IN(min)}} = \frac{I_{\text{LOAD}} \times V_{\text{OUT}}}{V_{\text{RIPPLE(CAP)}} \times V_{\text{IN}} \times F_{\text{SW}}} = \frac{10 \times 0.6 \text{ V}}{150 \text{ mV} \times 3.3 \text{ V} \times 300 \text{ kHz}} = 40.4 \mu\text{F} \quad (43)$$

$$\text{ESR}_{\text{MAX}} = \frac{V_{\text{RIPPLE(ESR)}}}{I_{\text{LOAD}} + \frac{1}{2}I_{\text{RIPPLE}}} = \frac{150 \text{ mV}}{11.6 \text{ A}} = 13 \text{ m}\Omega \quad (44)$$

The RMS current in the input capacitors is estimated by [Equation 45](#).

$$I_{\text{RMS_CIN}} = I_{\text{LOAD}} \times \sqrt{D \times (1-D)} = 10 \text{ A} \times \sqrt{0.2 \times (1-0.2)} = 4 \text{ Arms} \quad (45)$$

Five 1210, 10- μF , 25-V, X5R ceramic capacitors with approximately 2-m Ω of ESR and a 2.5-A RMS current rating each are selected. Higher voltage capacitors are selected to minimize capacitance loss at the DC bias voltage to ensure the capacitors allow sufficient capacitance at the working voltage.

8.2.3.2.6 MOSFET Switch Selection (Q1 and Q2)

Reviewing available TI NexFET MOSFETs using the TI NexFET MOSFET selection tool, the CSD16323Q3 and CSD16323Q3 5-mm \times 6-mm MOSFETs are selected. These two FETs have maximum total gate charges of 8.4 nC.

8.2.3.2.7 Bootstrap Capacitor (C6)

To ensure proper charging of the high-side FET gate, limit the ripple voltage on the boost capacitor to less than 50 mV.

$$C_{\text{Boost}} = 20 \times Q_{\text{G1}} = 20 \times 8.4 \text{ nC} = 100 \text{ nF} \quad (46)$$

8.2.3.2.8 VDD Bypass Capacitor (C7)

Per the TPS40305 [Electrical Characteristics](#) specifications, select a 1.0-μF X5R or better ceramic bypass capacitor for VDD.

8.2.3.2.9 BP Bypass Capacitor (C5)

Per the TPS40303 data sheet, a minimum 1.0-μF ceramic capacitance is required to stabilize the BP regulator. To limit regulator noise to less than 10 mV, the value of the bypass capacitor is calculated in [Equation 47](#).

$$C_{BP} = 100 \times \text{MAX}(Q_{G1}, Q_{G2}) \quad (47)$$

Because both Q1 and Q2's are the same, total gate charge is 8.4 nC, a BP capacitor of 0.84 μF is calculated. A standard value of 1.0 μF is selected to limit noise on the BP regulator.

8.2.3.2.10 Short-Circuit Protection (R11)

The TPS40305 uses the negative drop across the low-side FET at the end of the OFF time to measure the inductor current. Allowing for 30% over maximum load and 20% rise in $R_{DS(on)Q1}$ for self-heating, the voltage drop across the low-side FET at current limit is given by [Equation 48](#).

$$V_{OC} = (1.3 \times I_{LOAD} - \frac{1}{2} I_{ripple}) \times 1.2 \times R_{DSONQ2} = (1.3 \times 10A - \frac{1}{2} 3.2A) \times 1.2 \times 4.4m\Omega = 60mV \quad (48)$$

The TPS40305 internal temperature coefficient helps compensate for the MOSFET's $R_{DS(on)}$ temperature coefficient, so the current limit programming resistor is selected by [Equation 49](#).

$$R_{CS} = \frac{V_{OC} - V_{OCLOS(min)}}{2 \times I_{OCSET(min)}} = \frac{60mV - (-8mV)}{2 \times 9.5\mu A} = 3.6k\Omega \quad (49)$$

8.2.3.2.11 Feedback Divider (R4, R5)

The TPS40305 controller uses a full operational amplifier with an internally fixed 0.600-V reference. R5 is selected between 10 kΩ and 50 kΩ for a balance of feedback current and noise immunity. With R5 set to 10 kΩ, the output voltage is programmed with a resistor divider given by [Equation 50](#). Because the feedback voltage is equal to output voltage, low-side voltage divider resistor is not needed.

$$R_{Lowside} = \frac{V_{FB} \times R5}{V_{OUT} - V_{FB}} \quad (50)$$

8.2.3.2.12 Compensation: (C2, C3, C4, R3, R6)

Using the TPS40k Loop Stability Tool for 100-kHz bandwidth and 60° phase margin with a R5 value of 10 kΩ, the following values are returned.

- C8 = 10 nF
- C14 = 270 pF
- C15 = 4.7 nF
- R6 = 2.74 kΩ
- R3 = 1 kΩ

8.2.3.3 Application Curves

A typical efficiency graph for this design example using the TPS40303 is shown in Figure 23. The typical line and load regulation this design example using the TPS40303 is shown in Figure 24

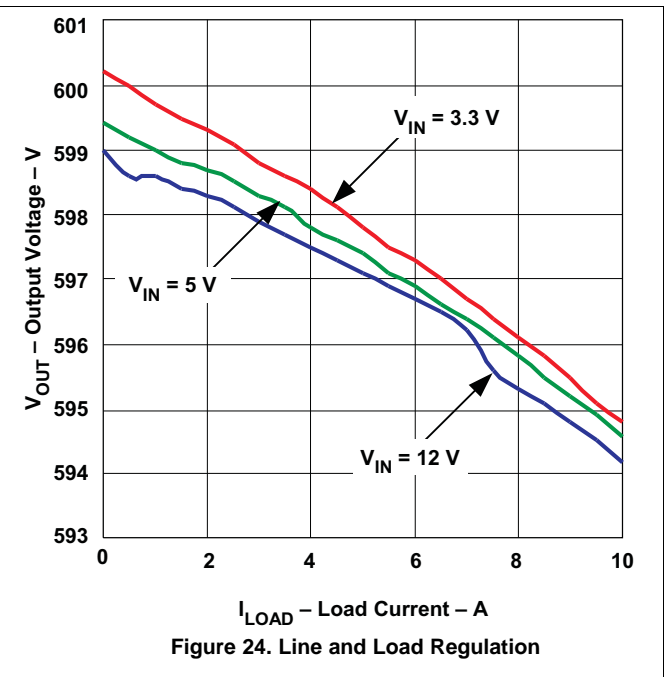
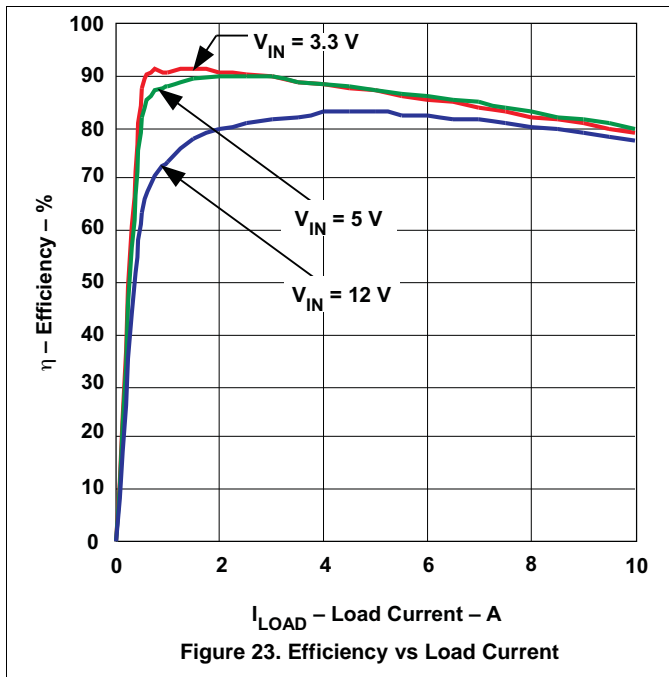

9 Power Supply Recommendations

These devices are designed to operate from an input voltage supply between 3 V and 20 V. This input supply should remain within the input voltage supply range. This supply must be well regulated.

10 Layout

10.1 Layout Guidelines

- For MOSFET or Power Block Layout, follow the layout recommendations provided for the MOSFET or Power Block selected.
- Connect VDD to VIN as close as possible to the drain connection of the high-side FET to avoid introducing additional drop which could trigger short-circuit protection.
- Place VDD and BP to GND capacitors within 2 mm of the device and connected to the Thermal Pad (GND).
- The FB to GND resistor should connect to the thermal tab (GND) with a minimum 10-mil wide trace.
- Place VOUT to FB resistor within 2 mm of the FB pin.
- The EN/SS-to-GND capacitor must connect to the thermal tab (GND) with a minimum 10-mil-wide trace. It may share this trace with FB to GND.
- If a BJT or MOSFET is used to disable EN/SS, place it within 5 mm of the device.
- If a COMP to GND resistor is used, place it within 5 mm of the device.
- All COMP and FB traces should be kept minimum line width and as short as possible to minimize noise coupling.
- Do not route EN/SS more than 20 mm from the device.
- If multiple layers are used, extend GND under all components connected to FB, COMP and EN/SS to reduce noise sensitivity.
- HDRV and LDRV should provide short, low inductance paths of 5 mm or less to the gates of the MOSFETs or Power Block.
- No more than 1 Ω of resistance should be placed between HDRV or LDRV and their MOSFET or Power Block gate pins.
- LDRV / OC to GND Current Limit Programming resistor may be placed on the far side of the MOSFET if necessary to ensure a short connection from LDRV to the gate of the low-side MOSFET.
- The BOOT to SW resistor and capacitor should both be placed within 4 mm of the device using a minimum of 10-mil-wide trace. The full width of the component pads are preferred for trace widths if design rules allow.
- If via must be used between the HDRV, SW and LDRV pins and their respective MOSFET or Power Block connections, use a minimum of two vias to reduce parasitic inductance
- Refer to the Land Pattern Data for the preferred layout of thermal vias within the thermal pad.
- It is recommended to extend the top-layer copper area of the thermal pad (GND) beyond the package a minimum 3 mm between pins 1 and 10 and 5 and 6 to improve thermal resistance to ambient of the device.

10.2 Layout Example

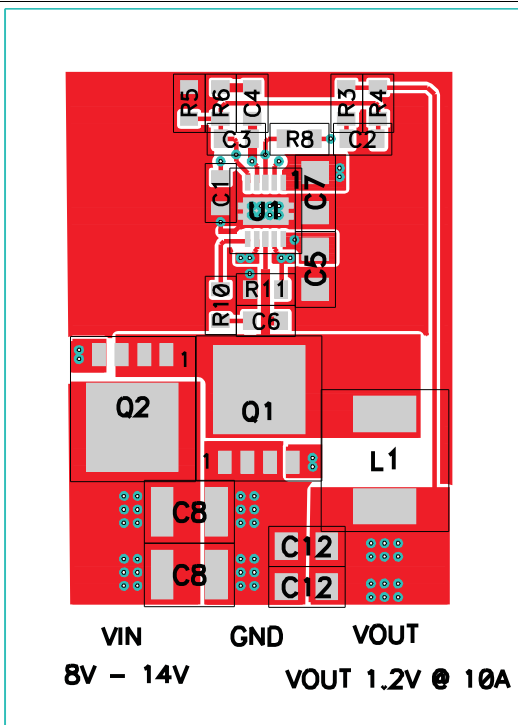

Figure 26. Top Copper With Components

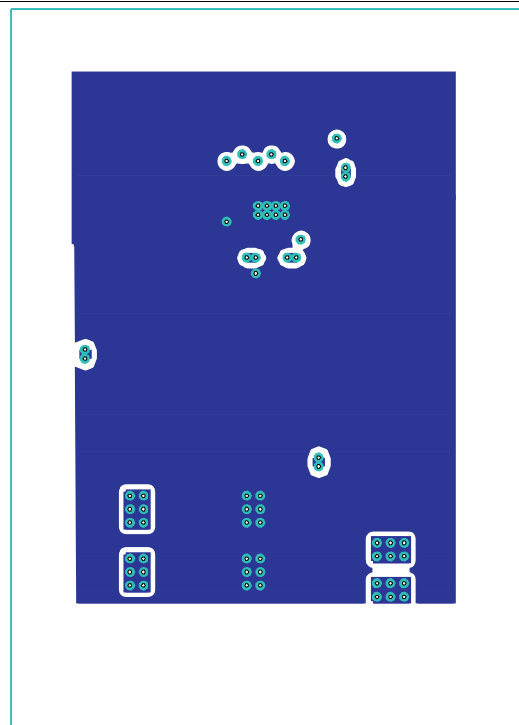

Figure 27. Top Internal Copper Layout

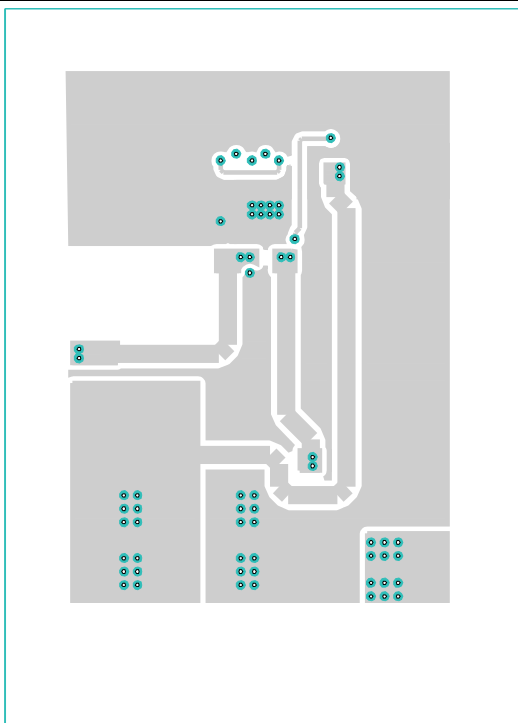

Figure 28. Bottom Internal Copper Layout

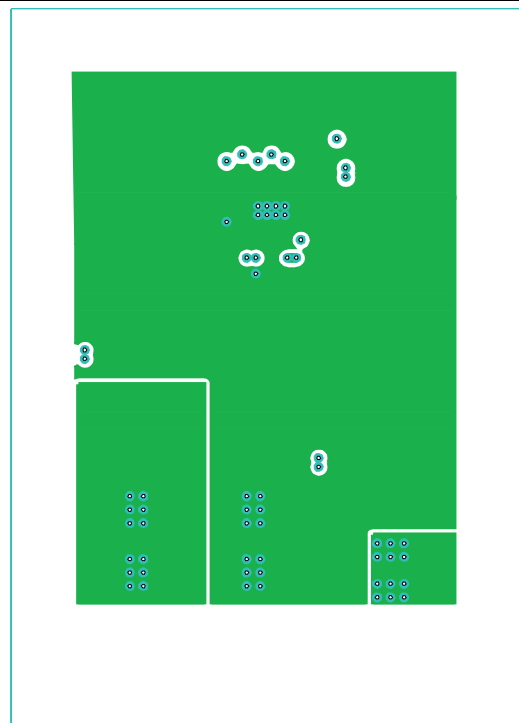

Figure 29. Bottom Copper Layer

11 Device and Documentation Support

11.1 Device Support

11.1.1 Third-Party Products Disclaimer

TI'S PUBLICATION OF INFORMATION REGARDING THIRD-PARTY PRODUCTS OR SERVICES DOES NOT CONSTITUTE AN ENDORSEMENT REGARDING THE SUITABILITY OF SUCH PRODUCTS OR SERVICES OR A WARRANTY, REPRESENTATION OR ENDORSEMENT OF SUCH PRODUCTS OR SERVICES, EITHER ALONE OR IN COMBINATION WITH ANY TI PRODUCT OR SERVICE.

11.2 Custom Design With WEBENCH® Tools

[Click here](#) to create a custom design using the TPS4030x devices with the WEBENCH® Power Designer.

1. Start by entering the input voltage (V_{IN}), output voltage (V_{OUT}), and output current (I_{OUT}) requirements.
2. Optimize the design for key parameters such as efficiency, footprint, and cost using the optimizer dial.
3. Compare the generated design with other possible solutions from Texas Instruments.

The WEBENCH Power Designer provides a customized schematic along with a list of materials with real-time pricing and component availability.

In most cases, these actions are available:

- Run electrical simulations to see important waveforms and circuit performance
- Run thermal simulations to understand board thermal performance
- Export customized schematic and layout into popular CAD formats
- Print PDF reports for the design, and share the design with colleagues

Get more information about WEBENCH tools at www.ti.com/WEBENCH.

11.3 Documentation Support

11.3.1 Related Documentation

These references, design tools and links to additional references, including design software, may be found at <http://power.ti.com>

1. Additional PowerPAD™ information may be found in Applications Briefs ([SLMA002](#)) and ([SLMA004](#)).
2. *Under The Hood Of Low Voltage DC/DC Converters* – SEM1500 Topic 5 – 2002 Seminar Series
3. *Understanding Buck Power Stages in Switchmode Power Supplies*, ([SLVA057](#)), March 1999
4. *Designing Stable Control Loops* – SEM 1400 – 2001 Seminar Series

11.4 Related Links

The table below lists quick access links. Categories include technical documents, support and community resources, tools and software, and quick access to sample or buy.

Table 8. Related Links

PARTS	PRODUCT FOLDER	SAMPLE & BUY	TECHNICAL DOCUMENTS	TOOLS & SOFTWARE	SUPPORT & COMMUNITY
TPS40303	Click here	Click here	Click here	Click here	Click here
TPS40304	Click here	Click here	Click here	Click here	Click here
TPS40305	Click here	Click here	Click here	Click here	Click here

11.5 Receiving Notification of Documentation Updates

To receive notification of documentation updates, navigate to the device product folder on ti.com. In the upper right corner, click on *Alert me* to register and receive a weekly digest of any product information that has changed. For change details, review the revision history included in any revised document.

11.6 Community Resources

The following links connect to TI community resources. Linked contents are provided "AS IS" by the respective contributors. They do not constitute TI specifications and do not necessarily reflect TI's views; see TI's [Terms of Use](#).

TI E2E™ Online Community *TI's Engineer-to-Engineer (E2E) Community*. Created to foster collaboration among engineers. At e2e.ti.com, you can ask questions, share knowledge, explore ideas and help solve problems with fellow engineers.

Design Support *TI's Design Support* Quickly find helpful E2E forums along with design support tools and contact information for technical support.

11.7 Trademarks

E2E is a trademark of Texas Instruments.

WEBENCH is a registered trademark of Texas Instruments.

All other trademarks are the property of their respective owners.

11.8 Electrostatic Discharge Caution



These devices have limited built-in ESD protection. The leads should be shorted together or the device placed in conductive foam during storage or handling to prevent electrostatic damage to the MOS gates.

11.9 Glossary

SLYZ022 — *TI Glossary*.

This glossary lists and explains terms, acronyms, and definitions.

12 Mechanical, Packaging, and Orderable Information

The following pages include mechanical, packaging, and orderable information. This information is the most current data available for the designated devices. This data is subject to change without notice and revision of this document. For browser-based versions of this data sheet, refer to the left-hand navigation.

PACKAGING INFORMATION

Orderable Device	Status (1)	Package Type	Package Drawing	Pins	Package Qty	Eco Plan (2)	Lead finish/ Ball material (6)	MSL Peak Temp (3)	Op Temp (°C)	Device Marking (4/5)	Samples
TPS40303DRCR	ACTIVE	VSON	DRC	10	3000	RoHS & Green	NIPDAU NIPDAUAG	Level-2-260C-1 YEAR	-40 to 125	0303	Samples
TPS40303DRCT	ACTIVE	VSON	DRC	10	250	RoHS & Green	NIPDAU NIPDAUAG	Level-2-260C-1 YEAR	-40 to 125	0303	Samples
TPS40304DRCR	ACTIVE	VSON	DRC	10	3000	RoHS & Green	NIPDAU NIPDAUAG	Level-2-260C-1 YEAR	-40 to 125	0304	Samples
TPS40304DRCT	ACTIVE	VSON	DRC	10	250	RoHS & Green	NIPDAUAG	Level-2-260C-1 YEAR	-40 to 125	0304	Samples
TPS40305DRCR	ACTIVE	VSON	DRC	10	3000	RoHS & Green	NIPDAU NIPDAUAG	Level-2-260C-1 YEAR	-40 to 125	0305	Samples
TPS40305DRCT	ACTIVE	VSON	DRC	10	250	RoHS & Green	NIPDAU NIPDAUAG	Level-2-260C-1 YEAR	-40 to 125	0305	Samples

(1) The marketing status values are defined as follows:

ACTIVE: Product device recommended for new designs.

LIFEBUY: TI has announced that the device will be discontinued, and a lifetime-buy period is in effect.

NRND: Not recommended for new designs. Device is in production to support existing customers, but TI does not recommend using this part in a new design.

PREVIEW: Device has been announced but is not in production. Samples may or may not be available.

OBSOLETE: TI has discontinued the production of the device.

(2) **RoHS:** TI defines "RoHS" to mean semiconductor products that are compliant with the current EU RoHS requirements for all 10 RoHS substances, including the requirement that RoHS substance do not exceed 0.1% by weight in homogeneous materials. Where designed to be soldered at high temperatures, "RoHS" products are suitable for use in specified lead-free processes. TI may reference these types of products as "Pb-Free".

RoHS Exempt: TI defines "RoHS Exempt" to mean products that contain lead but are compliant with EU RoHS pursuant to a specific EU RoHS exemption.

Green: TI defines "Green" to mean the content of Chlorine (Cl) and Bromine (Br) based flame retardants meet JS709B low halogen requirements of <=1000ppm threshold. Antimony trioxide based flame retardants must also meet the <=1000ppm threshold requirement.

(3) MSL, Peak Temp. - The Moisture Sensitivity Level rating according to the JEDEC industry standard classifications, and peak solder temperature.

(4) There may be additional marking, which relates to the logo, the lot trace code information, or the environmental category on the device.

(5) Multiple Device Markings will be inside parentheses. Only one Device Marking contained in parentheses and separated by a "-" will appear on a device. If a line is indented then it is a continuation of the previous line and the two combined represent the entire Device Marking for that device.

(6) Lead finish/Ball material - Orderable Devices may have multiple material finish options. Finish options are separated by a vertical ruled line. Lead finish/Ball material values may wrap to two lines if the finish value exceeds the maximum column width.

Important Information and Disclaimer: The information provided on this page represents TI's knowledge and belief as of the date that it is provided. TI bases its knowledge and belief on information provided by third parties, and makes no representation or warranty as to the accuracy of such information. Efforts are underway to better integrate information from third parties. TI has taken and continues to take reasonable steps to provide representative and accurate information but may not have conducted destructive testing or chemical analysis on incoming materials and chemicals. TI and TI suppliers consider certain information to be proprietary, and thus CAS numbers and other limited information may not be available for release.

In no event shall TI's liability arising out of such information exceed the total purchase price of the TI part(s) at issue in this document sold by TI to Customer on an annual basis.

TAPE AND REEL INFORMATION

QUADRANT ASSIGNMENTS FOR PIN 1 ORIENTATION IN TAPE

*All dimensions are nominal

Device	Package Type	Package Drawing	Pins	SPQ	Reel Diameter (mm)	Reel Width W1 (mm)	A0 (mm)	B0 (mm)	K0 (mm)	P1 (mm)	W (mm)	Pin1 Quadrant
TPS40303DRCR	VSON	DRC	10	3000	330.0	12.4	3.3	3.3	1.1	8.0	12.0	Q2
TPS40303DRCT	VSON	DRC	10	250	180.0	12.4	3.3	3.3	1.1	8.0	12.0	Q2
TPS40304DRCR	VSON	DRC	10	3000	330.0	12.4	3.3	3.3	1.1	8.0	12.0	Q2
TPS40304DRCT	VSON	DRC	10	250	180.0	12.5	3.3	3.3	1.1	8.0	12.0	Q2
TPS40305DRCR	VSON	DRC	10	3000	330.0	12.4	3.3	3.3	1.1	8.0	12.0	Q2
TPS40305DRCT	VSON	DRC	10	250	180.0	12.5	3.3	3.3	1.1	8.0	12.0	Q2

TAPE AND REEL BOX DIMENSIONS

*All dimensions are nominal

Device	Package Type	Package Drawing	Pins	SPQ	Length (mm)	Width (mm)	Height (mm)
TPS40303DRCR	VSON	DRC	10	3000	356.0	356.0	35.0
TPS40303DRCT	VSON	DRC	10	250	210.0	185.0	35.0
TPS40304DRCR	VSON	DRC	10	3000	338.0	355.0	50.0
TPS40304DRCT	VSON	DRC	10	250	338.0	355.0	50.0
TPS40305DRCR	VSON	DRC	10	3000	338.0	355.0	50.0
TPS40305DRCT	VSON	DRC	10	250	338.0	355.0	50.0

GENERIC PACKAGE VIEW

DRC 10

VSON - 1 mm max height

3 x 3, 0.5 mm pitch

PLASTIC SMALL OUTLINE - NO LEAD

This image is a representation of the package family, actual package may vary.
Refer to the product data sheet for package details.

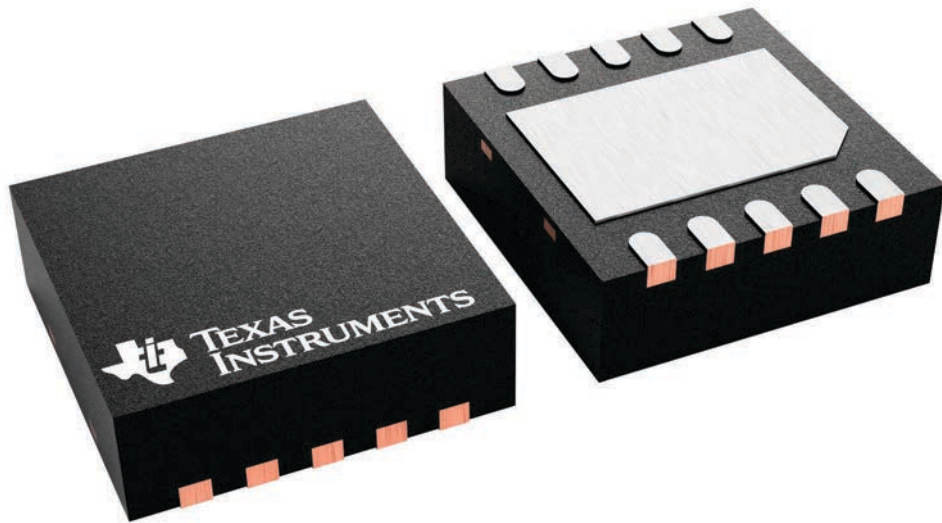

4226193/A

EXAMPLE BOARD LAYOUT

DRC0010J

VSON - 1 mm max height

PLASTIC SMALL OUTLINE - NO LEAD

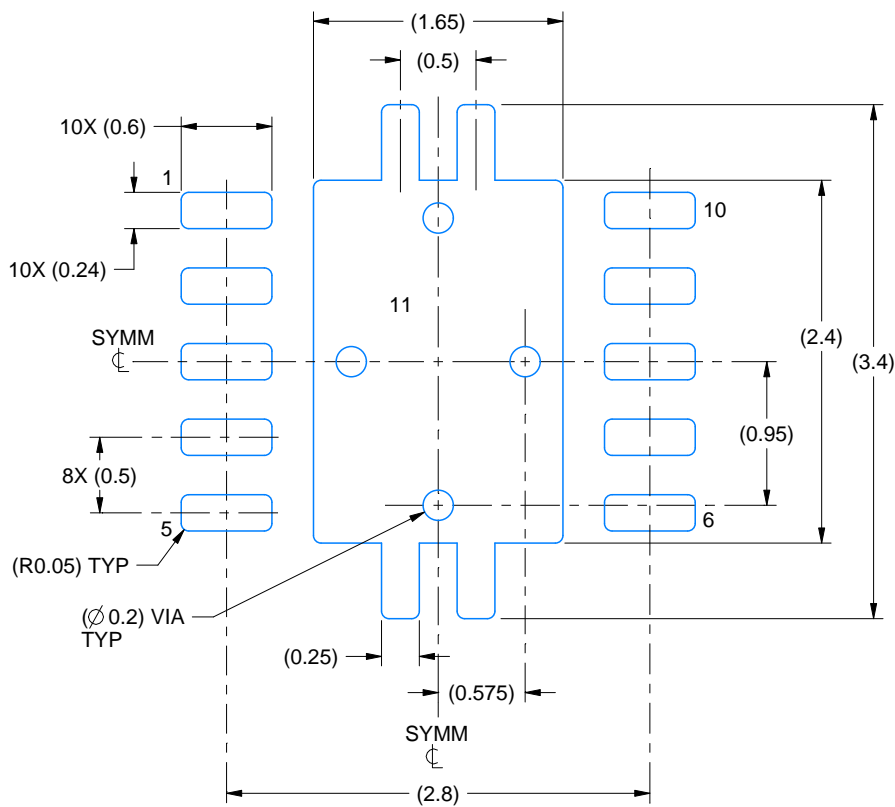

LAND PATTERN EXAMPLE
EXPOSED METAL SHOWN
SCALE:20X

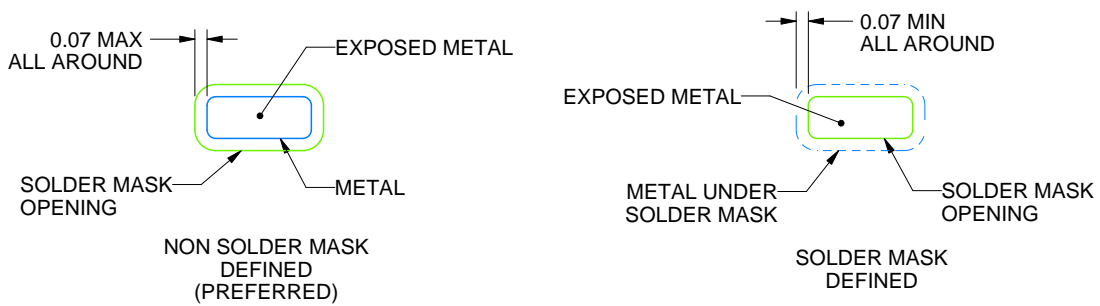

SOLDER MASK DETAILS

4218878/B 07/2018

NOTES: (continued)

4. This package is designed to be soldered to a thermal pad on the board. For more information, see Texas Instruments literature number SLUA271 (www.ti.com/lit/sluea271).
5. Vias are optional depending on application, refer to device data sheet. If any vias are implemented, refer to their locations shown on this view. It is recommended that vias under paste be filled, plugged or tented.

EXAMPLE STENCIL DESIGN

DRC0010J

VSON - 1 mm max height

PLASTIC SMALL OUTLINE - NO LEAD

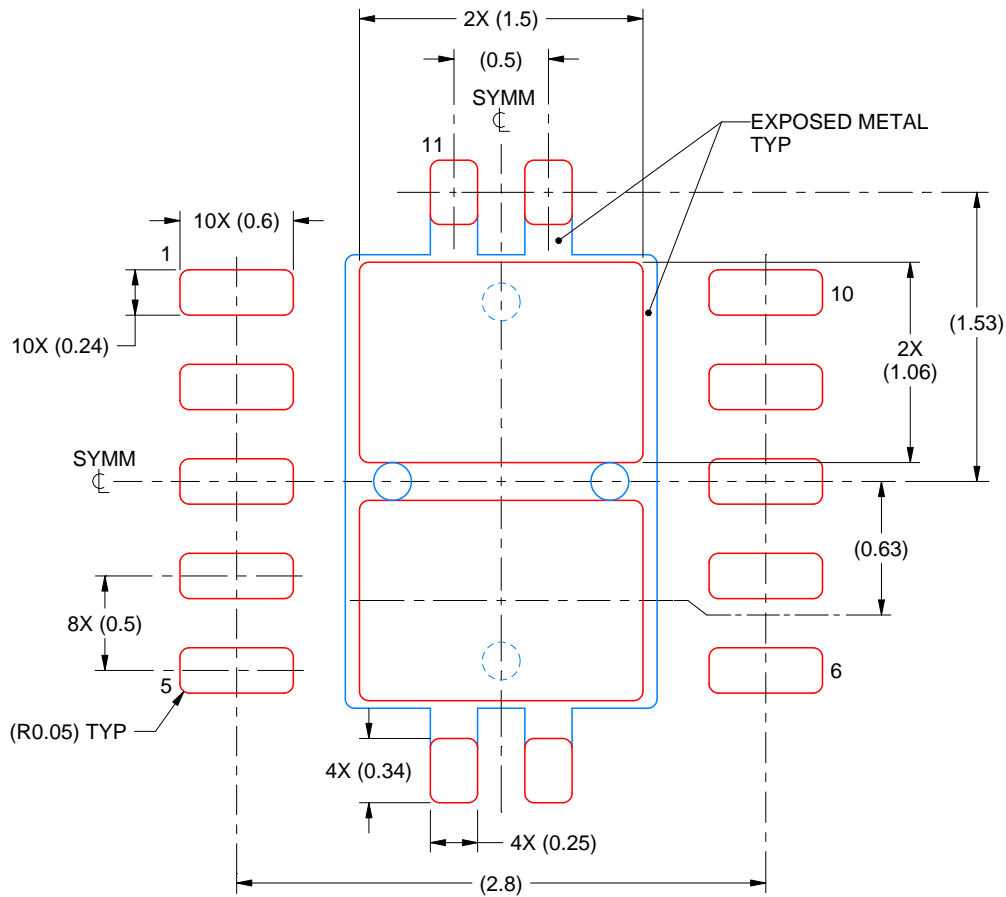

SOLDER PASTE EXAMPLE
BASED ON 0.125 mm THICK STENCIL

EXPOSED PAD 11:
80% PRINTED SOLDER COVERAGE BY AREA
SCALE:25X

4218878/B 07/2018

NOTES: (continued)

6. Laser cutting apertures with trapezoidal walls and rounded corners may offer better paste release. IPC-7525 may have alternate design recommendations.

IMPORTANT NOTICE AND DISCLAIMER

TI PROVIDES TECHNICAL AND RELIABILITY DATA (INCLUDING DATA SHEETS), DESIGN RESOURCES (INCLUDING REFERENCE DESIGNS), APPLICATION OR OTHER DESIGN ADVICE, WEB TOOLS, SAFETY INFORMATION, AND OTHER RESOURCES "AS IS" AND WITH ALL FAULTS, AND DISCLAIMS ALL WARRANTIES, EXPRESS AND IMPLIED, INCLUDING WITHOUT LIMITATION ANY IMPLIED WARRANTIES OF MERCHANTABILITY, FITNESS FOR A PARTICULAR PURPOSE OR NON-INFRINGEMENT OF THIRD PARTY INTELLECTUAL PROPERTY RIGHTS.

These resources are intended for skilled developers designing with TI products. You are solely responsible for (1) selecting the appropriate TI products for your application, (2) designing, validating and testing your application, and (3) ensuring your application meets applicable standards, and any other safety, security, regulatory or other requirements.

These resources are subject to change without notice. TI grants you permission to use these resources only for development of an application that uses the TI products described in the resource. Other reproduction and display of these resources is prohibited. No license is granted to any other TI intellectual property right or to any third party intellectual property right. TI disclaims responsibility for, and you will fully indemnify TI and its representatives against, any claims, damages, costs, losses, and liabilities arising out of your use of these resources.

TI's products are provided subject to [TI's Terms of Sale](#) or other applicable terms available either on [ti.com](https://www.ti.com) or provided in conjunction with such TI products. TI's provision of these resources does not expand or otherwise alter TI's applicable warranties or warranty disclaimers for TI products.

TI objects to and rejects any additional or different terms you may have proposed.

Mailing Address: Texas Instruments, Post Office Box 655303, Dallas, Texas 75265
Copyright © 2024, Texas Instruments Incorporated

Looking for pricing, stock, or lifecycle information?

Click below to explore more details on WIN SOURCE:

 [View TPS40304DRCR](#) on WIN SOURCE

 [Texas Instruments](#) Information

Optimize Your Supply Chain with WIN SOURCE Solutions

-  Global Sourcing Solution
-  Obsolete Management
-  Cost Control Management
-  Shortage Management
-  Alternative Solution
-  Excess Inventory Management