



**THE DATASHEET OF  
TPS56121DQPR**



## TPS56121 4.5-V to 14-V Input High-Current Synchronous Buck SWIFT™ Converter

### 1 Features

- 4.5-V to 14-V Input Voltage Range
- Incorporates Power Block Technology
- Up to 15-A Output Current
- Fixed-Frequency Options of 300 kHz, 500 kHz, and 1 MHz
- High-Side and Low-Side MOSFET  $R_{DS(on)}$  Sensing
- Programmable Soft-Start
- 600-mV Reference Voltage With 1% Accuracy
- Voltage Mode Control with Feed-Forward
- Supports Prebiased Output
- Thermal Shutdown
- 22-Pin 5-mm x 6-mm PQFN PowerPAD™ Package
- For SWIFT™ Power Products Documentation, see <http://www.ti.com/swift>

### 2 Applications

- Point-of-Load (POL) Power Modules
- High-Density DC-DC Converters for Telecom and Networking Applications

### 3 Description

The TPS56121 device is a high-efficiency and high-current synchronous buck converter designed to operate from a supply of 4.5 V to 14 V. The device can produce an output voltage as low as 0.6 V at loads up to 15 A. Integrated NexFET™ Power MOSFETs provide a small footprint and ease of use.

The device implements a voltage-mode control with voltage feed-forward compensation that responds instantly to input voltage change.

The TPS56121 is available in a thermally enhanced 22-pin PQFN (DQP) PowerPAD package.

The device offers design flexibility with a variety of user programmable functions, including soft-start, overcurrent protection (OCP) levels, and loop compensation. OCP levels are programmed by a single external resistor connected from the ILIM pin to the circuit ground. During the initial power-on sequence, the device enters a calibration cycle, measures the voltage at the ILIM pin, and sets an internal OCP voltage level. During operation, the programmed OCP voltage level is compared to the voltage drop across the low-side FET when it is on to determine whether there is an overcurrent condition and then enters a shutdown/restart cycle until the fault is removed.

#### Device Information<sup>(1)</sup>

PART NUMBER	PACKAGE	BODY SIZE (NOM)
TPS56121	LSON-CLIP (22)	6.00 mm x 5.00 mm

(1) For all available packages, see the orderable addendum at the end of the datasheet.

#### Simplified Application

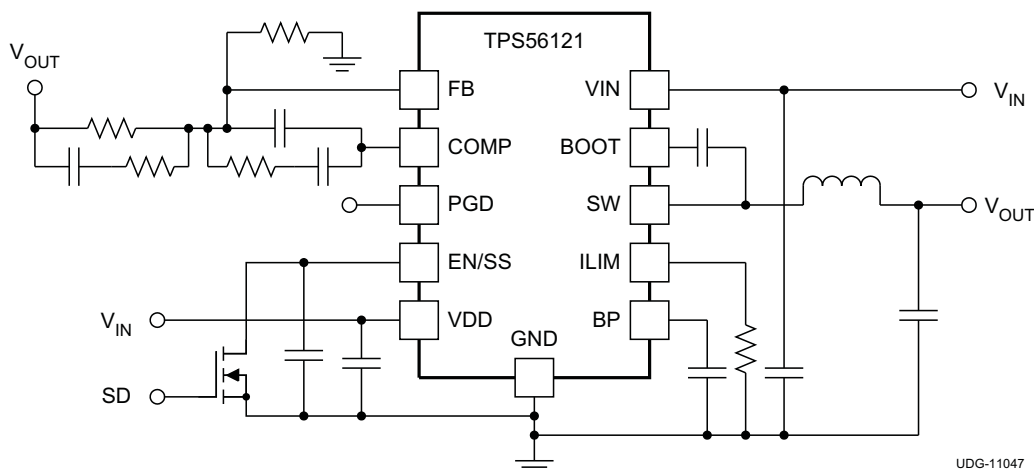

## Table of Contents

<b>1 Features</b> .....	<b>1</b>	7.3 Feature Description .....	<b>10</b>
<b>2 Applications</b> .....	<b>1</b>	7.4 Device Functional Modes .....	<b>14</b>
<b>3 Description</b> .....	<b>1</b>	<b>8 Application and Implementation</b> .....	<b>15</b>
<b>4 Revision History</b> .....	<b>2</b>	8.1 Application Information .....	<b>15</b>
<b>5 Pin Configuration and Functions</b> .....	<b>3</b>	8.2 Typical Application .....	<b>15</b>
<b>6 Specifications</b> .....	<b>4</b>	<b>9 Power Supply Recommendations</b> .....	<b>21</b>
6.1 Absolute Maximum Ratings .....	<b>4</b>	<b>10 Layout</b> .....	<b>21</b>
6.2 ESD Ratings .....	<b>4</b>	10.1 Layout Guidelines .....	<b>21</b>
6.3 Recommended Operating Conditions .....	<b>4</b>	10.2 Layout Example .....	<b>21</b>
6.4 Thermal Information .....	<b>5</b>	<b>11 Device and Documentation Support</b> .....	<b>23</b>
6.5 Electrical Characteristics .....	<b>5</b>	11.1 Device Support .....	<b>23</b>
6.6 Typical Characteristics .....	<b>7</b>	11.2 Trademarks .....	<b>23</b>
<b>7 Detailed Description</b> .....	<b>10</b>	11.3 Electrostatic Discharge Caution .....	<b>23</b>
7.1 Overview .....	<b>10</b>	11.4 Glossary .....	<b>23</b>
7.2 Functional Block Diagram .....	<b>10</b>	<b>12 Mechanical, Packaging, and Orderable Information</b> .....	<b>23</b>

## 4 Revision History

NOTE: Page numbers for previous revisions may differ from page numbers in the current version.

### Changes from Revision C (January 2015) to Revision D Page

- Changed the datasheet Title From: "TPS56121 4.5-V to 14-V Input High-Current Synchronous Buck Converter" To: "TPS56121 4.5-V to 14-V Input High-Current Synchronous Buck SWIFT™ Converter" ..... **1**
- Added **Features**: "For SWIFT™ Power Products Documentation,..." ..... **1**

### Changes from Revision B (March 2013) to Revision C Page

- Added *Pin Configuration and Functions* section, *ESD Ratings* table, *Feature Description* section, *Device Functional Modes*, *Application and Implementation* section, *Power Supply Recommendations* section, *Layout* section, *Device and Documentation Support* section, and *Mechanical, Packaging, and Orderable Information* section ..... **1**

### Changes from Revision A (May 2012) to Revision B Page

- Changed BOOT resistor value from (5 Ω to 10 Ω) to (5 Ω to 15 Ω). ..... **3**
- Added Since the TPS56121 is designed for 15-A full-load current and not intentionally designed for an OCP level below 10 A, use an R<sub>OCPSET</sub> value above 1 kΩ to get an accurate OCP tripping point. .... **12**
- Changed BOOT resistor value from (5 Ω to 10 Ω) to (5 Ω to 15 Ω). ..... **13**

### Changes from Original (March 2011) to Revision A Page

- Changed characterization conditions ..... **9**
- Changed corrected typographical error in [Equation 2](#)..... **12**
- Added Switching Node (SW) section..... **13**
- Added clarity to Thermal Shutdown section ..... **13**
- Deleted old Design example..... **15**
- Added new Design example..... **15**
- Added Layout Recommendations section ..... **21**
- Added EVM Layout section ..... **21**

## 5 Pin Configuration and Functions

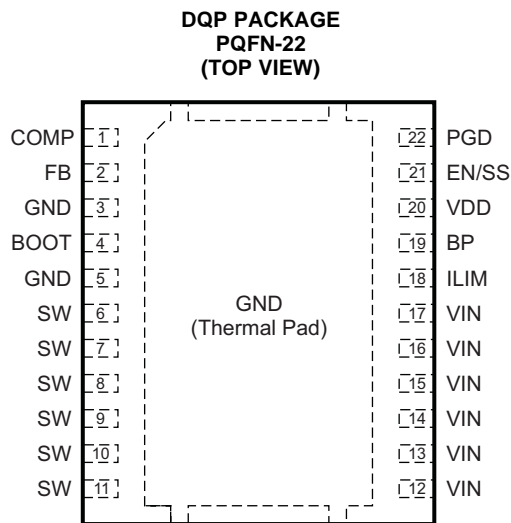

Note: The thermal pad is also an electrical ground connection.

### Pin Functions

PIN		I/O	DESCRIPTION
NAME	NO.		
BOOT	4	O	Gate drive voltage for the high-side FET. A 100-nF capacitor (typical) must be connected between this pin and the SW pin. To reduce a voltage spike at SW, a BOOT resistor with a value between 5 $\Omega$ to 15 $\Omega$ may be placed in series with the BOOT capacitor to slow down turn-on of the high-side FET.
BP	19	O	Output bypass for the internal regulator. Connect a low-ESR bypass ceramic capacitor of 1 $\mu$ F or greater from this pin to GND.
COMP	1	O	Output of the error amplifier and connection node for loop feedback components. Optionally, a 40.2 k $\Omega$ resistor from this pin to GND sets switching frequency to 300KHz instead of the default value of 500 kHz; while a 13.3-k $\Omega$ resistor from this pin to GND sets switching frequency to 1 MHz.
EN/SS	21	I	Logic-level input starts or stops the controller via an external user command. Allowing this pin to float turns the controller on. Pulling this pin low disables the controller. This is also the soft-start programming pin. A capacitor connected from this pin to GND programs the soft-start time. The capacitor is charged with an internal current source of 10 $\mu$ A. The resulting voltage ramp of this pin is also used as a second non-inverting input to the error amplifier after a 0.8 V (typical) level shift downwards. Output regulation is controlled by the internal level shifted voltage ramp until that voltage reaches the internal reference voltage of 600 mV. The voltage ramp of this pin reaches 1.4 V (typical).
FB	2	I	Inverting input to the error amplifier. In normal operation, the voltage on this pin is equal to the internal reference voltage.
GND	3	—	Ground reference for the device
	5		
GND	Thermal Pad	—	Ground reference for the device. This is also the thermal pad used to conduct heat from the device. This connection serves two purposes. The first is to provide an electrical ground connection for the device. The second is to provide a low thermal impedance path from the device die to the PCB. This pad should be tied externally to a ground plane.
ILIM	18	I	A resistor connected from this pin to GND sets the overcurrent threshold for the device (the low-side FET).
PGD	22	O	Open drain power good output.

**Pin Functions (continued)**

PIN		I/O	DESCRIPTION
NAME	NO.		
SW	6	I	Switching node of the power conversion stage. Sense line for the adaptive anti-cross conduction circuitry. Acts as the common connection for the flying high-side FET driver.
	7		
	8		
	9		
	10		
	11		
VDD	20	I	Power input to the controller. A low-ESR bypass ceramic capacitor of 1 $\mu$ F should be connected from this pin close to GND.
VIN	12	I	Power input to the high-side FET.
	13		
	14		
	15		
	16		
	17		

**6 Specifications**

**6.1 Absolute Maximum Ratings**

over operating free-air temperature range (unless otherwise noted) <sup>(1)</sup>

		MIN	MAX	UNIT
Voltage	VDD, VIN	-0.3	16.5	V
	SW	-3	25	
	SW (< 100 ns pulse width, 10 $\mu$ J)	-5		
	BOOT	-0.3	30	
	BOOT-SW (differential from BOOT to SW)	-0.3	7	
	COMP, PGOOD, FB, BP, EN/SS, ILIM	-0.3	7	
Temperature	Junction, T <sub>J</sub>	-40	150	°C
	Storage, T <sub>stg</sub>	-55	150	

(1) Stresses beyond those listed under *Absolute Maximum Ratings* may cause permanent damage to the device. These are stress ratings only and functional operation of the device at these or any other condition beyond those included under *Recommended Operating Conditions* is not implied. Exposure to absolute-maximum-rated conditions for extended periods of time may affect device reliability.

**6.2 ESD Ratings**

		VALUE	UNIT
V <sub>(ESD)</sub> Electrostatic discharge	Human-body model (HBM), per ANSI/ESDA/JEDEC JS-001 <sup>(1)</sup>	±2000	V
	Charged-device model (CDM), per JEDEC specification JESD22-C101 <sup>(2)</sup>	±1500	

(1) JEDEC document JEP155 states that 500-V HBM allows safe manufacturing with a standard ESD control process.  
 (2) JEDEC document JEP157 states that 250-V CDM allows safe manufacturing with a standard ESD control process.

**6.3 Recommended Operating Conditions**

over operating free-air temperature range (unless otherwise noted)

		MIN	NOM	MAX	UNIT
V <sub>DD</sub>	VIN Input voltage	4.5		14	V
T <sub>J</sub>	Operating junction temperature	-40		125	°C

## 6.4 Thermal Information

THERMAL METRIC <sup>(1)</sup>		TPS56121	UNIT
		DQP	
		22 PINS	
R <sub>θJA</sub>	Junction-to-ambient thermal resistance	34.6	°C/W
R <sub>θJC(top)</sub>	Junction-to-case (top) thermal resistance	22.9	
ψ <sub>JT</sub>	Junction-to-top characterization parameter	0.6	
ψ <sub>JB</sub>	Junction-to-board characterization parameter	5.0	
R <sub>θJC(bot)</sub>	Junction-to-case (bottom) thermal resistance	0.3	

(1) For more information about traditional and new thermal metrics, see the *IC Package Thermal Metrics* application report, [SPRA953](#).

## 6.5 Electrical Characteristics

–40°C ≤ T<sub>J</sub> ≤ 125°C, V<sub>VDD</sub> = 12 V, all parameters at zero power dissipation (unless otherwise noted)

PARAMETER		TEST CONDITIONS	MIN	TYP	MAX	UNIT
<b>VOLTAGE REFERENCE</b>						
V <sub>FB</sub>	FB input voltage	T <sub>J</sub> = 25°C, 4.5 V ≤ V <sub>VDD</sub> ≤ 14 V	597	600	603	mV
		–40°C ≤ T <sub>J</sub> ≤ 125°C, 4.5 V ≤ V <sub>VDD</sub> ≤ 14 V	594	600	606	
<b>INPUT SUPPLY</b>						
V <sub>VDD</sub>	Input supply voltage range		4.5		14	V
I <sub>VDDSD</sub>	Shutdown supply current	V <sub>EN/SS</sub> = 0.2 V		80	120	μA
I <sub>VDDQ</sub>	Quiescent, non-switching	Let EN/SS float, V <sub>FB</sub> = 1 V		2.5	5.0	mA
V <sub>UVLO</sub>	UVLO ON Voltage		4.0		4.3	V
V <sub>UVLO(HYS)</sub>	UVLO hysteresis		500		700	mV
<b>ENABLE/SOFT-START</b>						
V <sub>IH</sub>	High-level input voltage, EN/SS		0.55	0.70	1.00	V
V <sub>IL</sub>	Low-level input voltage, EN/SS		0.27	0.30	0.33	V
I <sub>SS</sub>	Soft-start source current		8	10	12	μA
V <sub>SS</sub>	Soft-start voltage level – Start of ramp		0.4	0.8	1.3	V
<b>BP REGULATOR</b>						
V <sub>BP</sub>	Output voltage	I <sub>BP</sub> = 10 mA	6.2	6.5	6.8	V
V <sub>DO</sub>	Regulator dropout voltage, V <sub>VDD</sub> – V <sub>BP</sub>	I <sub>BP</sub> = 25 mA, V <sub>VDD</sub> = 4.5 V		70	125	mV
<b>OSCILLATOR</b>						
f <sub>SW</sub>	Switching Frequency	R <sub>COMP</sub> = 40.2 kΩ, 4.5 V ≤ V <sub>VDD</sub> ≤ 14 V	270	300	330	kHz
		R <sub>COMP</sub> = open, 4.5 V ≤ V <sub>VDD</sub> ≤ 14 V	450	500	550	
		R <sub>COMP</sub> = 13.3 kΩ, 4.5 V ≤ V <sub>VDD</sub> ≤ 14 V	0.8	0.95	1.1	MHz
V <sub>RAMP</sub> <sup>(1)</sup>	Ramp amplitude		V <sub>VDD</sub> /6.6	V <sub>VDD</sub> /6	V <sub>VDD</sub> /5.4	V
<b>PWM</b>						
D <sub>MAX</sub> <sup>(1)</sup>	Maximum duty cycle	f <sub>sw</sub> = 300 kHz, V <sub>FB</sub> = 0 V, 4.5 V ≤ V <sub>VDD</sub> ≤ 14 V	93%			
		f <sub>sw</sub> = 500 kHz, V <sub>FB</sub> = 0 V, 4.5 V ≤ V <sub>VDD</sub> ≤ 14 V	90%			
		f <sub>sw</sub> = 1 MHz, V <sub>FB</sub> = 0 V, 4.5 V ≤ V <sub>VDD</sub> ≤ 14 V	85%			
t <sub>ON(min)</sub> <sup>(1)</sup>	Minimum controllable pulse width			100	ns	
<b>ERROR AMPLIFIER</b>						
GBWP <sup>(1)</sup>	Gain bandwidth product		10	24		MHz
A <sub>OL</sub> <sup>(1)</sup>	Open loop gain		60			dB

(1) Ensured by design. Not production tested

**Electrical Characteristics (continued)**
 $-40^{\circ}\text{C} \leq T_J \leq 125^{\circ}\text{C}$ ,  $V_{\text{VDD}} = 12\text{ V}$ , all parameters at zero power dissipation (unless otherwise noted)

PARAMETER		TEST CONDITIONS	MIN	TYP	MAX	UNIT
$I_{\text{IB}}$	Input bias current (current out of FB pin)	$V_{\text{FB}} = 0.6\text{ V}$			75	nA
$I_{\text{EAOP}}$	Output source current	$V_{\text{FB}} = 0\text{ V}$	1.5			mA
$I_{\text{EAOM}}$	Output sink current	$V_{\text{FB}} = 1\text{ V}$	1.5			mA
<b>POWER GOOD</b>						
$V_{\text{OV}}$	Feedback upper voltage limit for PGOOD		655	675	700	mV
$V_{\text{UV}}$	Feedback lower voltage limit for PGOOD		500	525	550	
$V_{\text{PGD-HYST}}$	PGOOD hysteresis voltage at FB			30	45	
$R_{\text{PGD}}$	PGOOD pull down resistance	$V_{\text{FB}} = 0\text{ V}$ , $I_{\text{FB}} = 5\text{ mA}$		30	70	$\Omega$
$I_{\text{PGDLK}}$	PGOOD leakage current	$550\text{ mV} < V_{\text{FB}} < 655\text{ mV}$ , $V_{\text{PGOOD}} = 5\text{ V}$		10	20	$\mu\text{A}$
<b>OUTPUT STAGE</b>						
$R_{\text{HI}}$	High-side device resistance	$T_J = 25^{\circ}\text{C}$ , $(V_{\text{BOOT}} - V_{\text{SW}}) = 5.5\text{ V}$		4.5	6.5	m $\Omega$
$R_{\text{LO}}$	Low side device resistance	$T_J = 25^{\circ}\text{C}$		1.9	2.7	
<b>OVERCURRENT PROTECTION (OCP)</b>						
$t_{\text{PSSC(min)}}$ <sup>(1)</sup>	Minimum pulse time during short circuit			250		ns
$t_{\text{BLNKH}}$ <sup>(1)</sup>	Switch leading-edge blanking pulse time (high-side detection)			150		
$I_{\text{OCH}}$	OC threshold for high-side FET	$T_J = 25^{\circ}\text{C}$ , $(V_{\text{BOOT}} - V_{\text{SW}}) = 5.5\text{ V}$	27	34	39	A
$I_{\text{ILIM}}$	ILIM current source	$T_J = 25^{\circ}\text{C}$		10.0		$\mu\text{A}$
$V_{\text{OCLPRO}}$ <sup>(1)</sup>	Programmable OC range for low side FET	$T_J = 25^{\circ}\text{C}$	12		100	mV
$t_{\text{OFF}}$	OC retry cycles on EN/SS pin			4		Cycle
<b>BOOT DIODE</b>						
$V_{\text{DFWD}}$	Bootstrap diode forward voltage	$I_{\text{BOOT}} = 5\text{ mA}$		0.8		V
<b>THERMAL SHUTDOWN</b>						
$T_{\text{JSD}}$ <sup>(1)</sup>	Junction shutdown temperature			145		$^{\circ}\text{C}$
$T_{\text{JSDH}}$ <sup>(1)</sup>	Hysteresis			20		$^{\circ}\text{C}$

## 6.6 Typical Characteristics

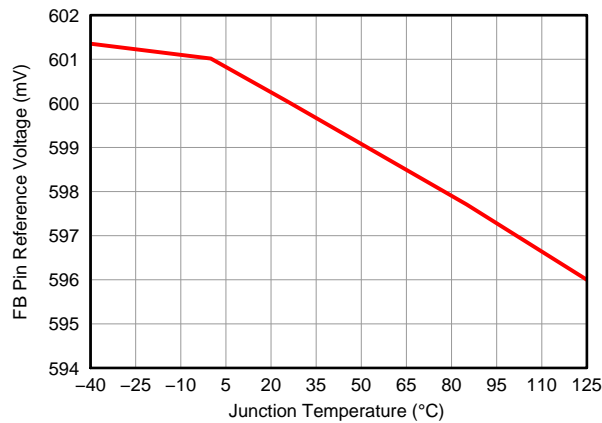

Figure 1. Reference Voltage vs. Junction Temperature

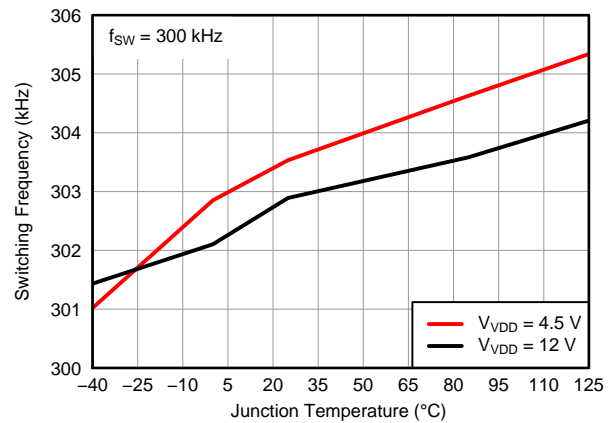

Figure 2. Switching Frequency vs. Junction Temperature (300 kHz)

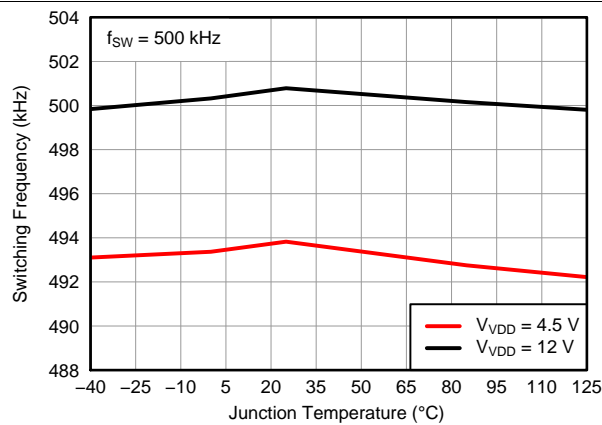

Figure 3. Switching Frequency vs. Junction Temperature (500 kHz)

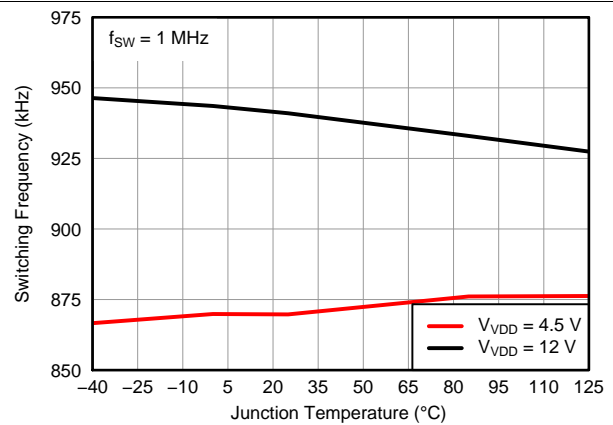

Figure 4. Switching Frequency vs. Junction Temperature (1 MHz)

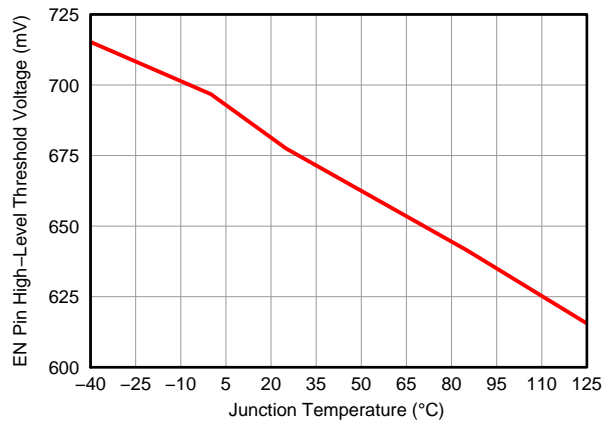

Figure 5. EN Pin High-Level Threshold Voltage vs. Junction Temperature

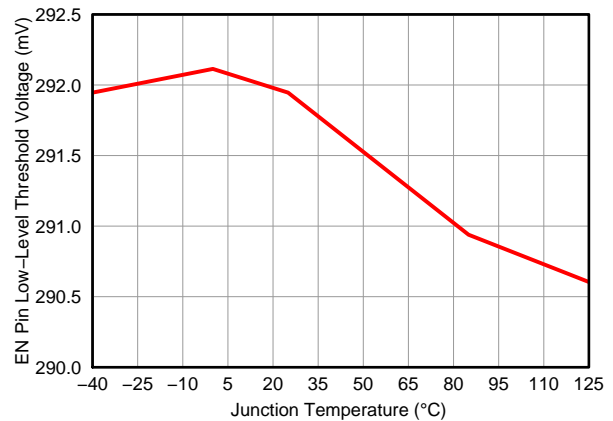

Figure 6. EN Pin Low-Level Threshold Voltage vs. Junction Temperature

Typical Characteristics (continued)

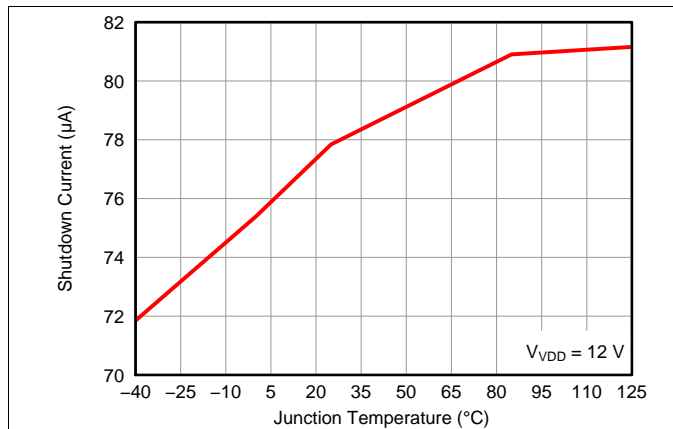

Figure 7. Shutdown Current vs. Junction Temperature

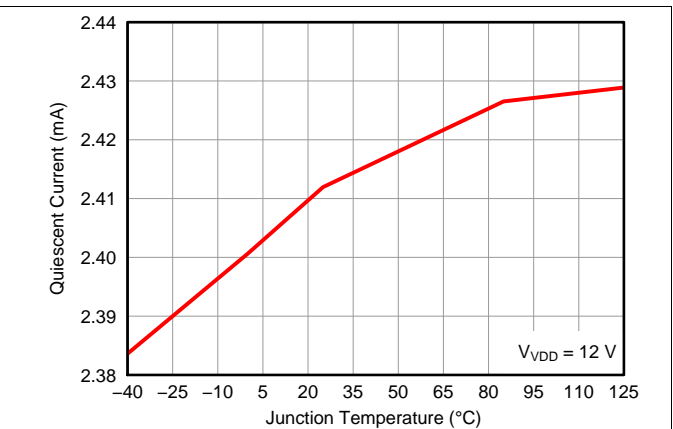

Figure 8. Quiescent Current vs. Junction Temperature

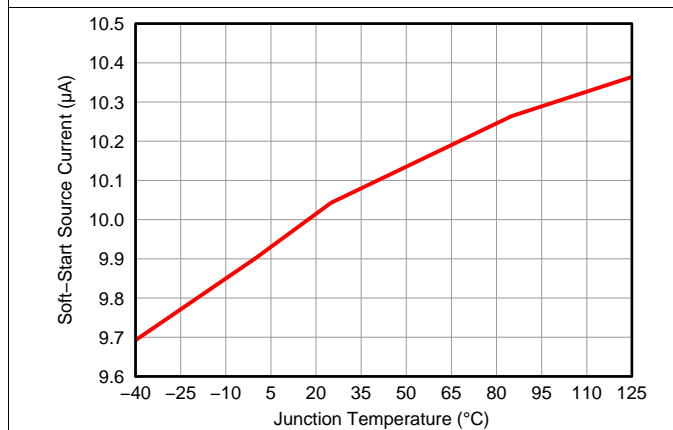

Figure 9. Soft-Start Source vs. Junction Temperature

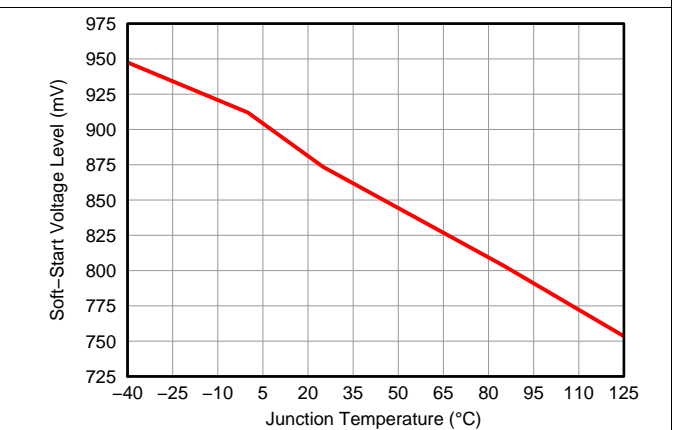

Figure 10. Soft-Start Voltage Level vs. Junction Temperature

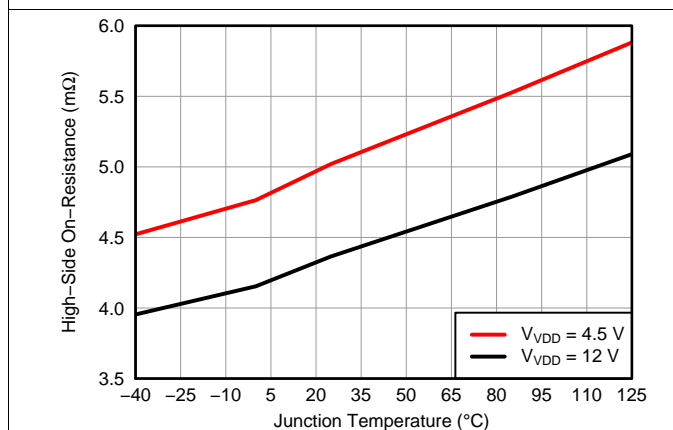

Figure 11. High-Side On Resistance vs. Junction Temperature

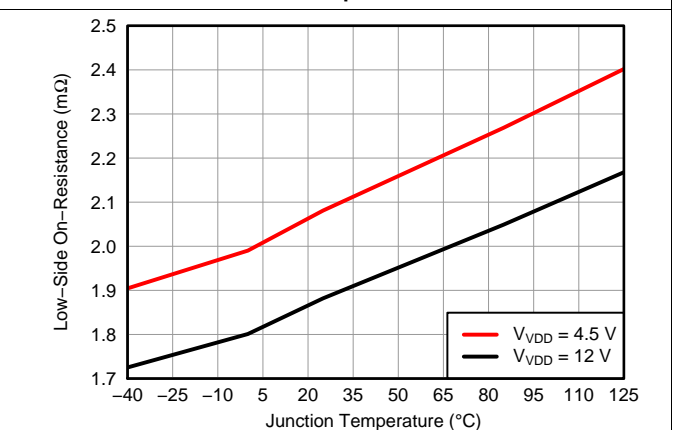
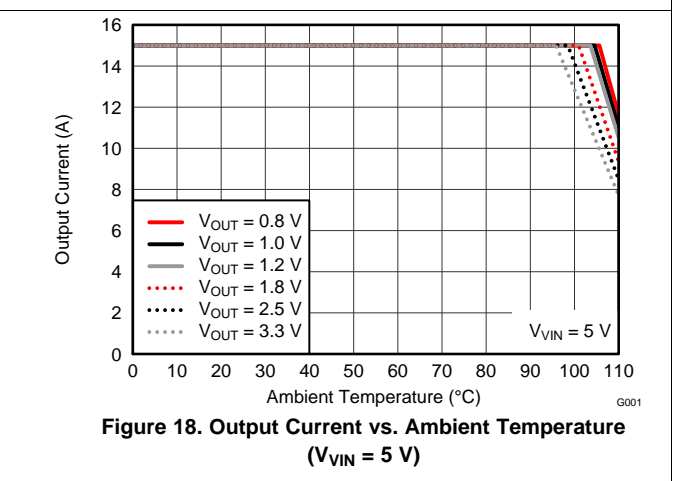
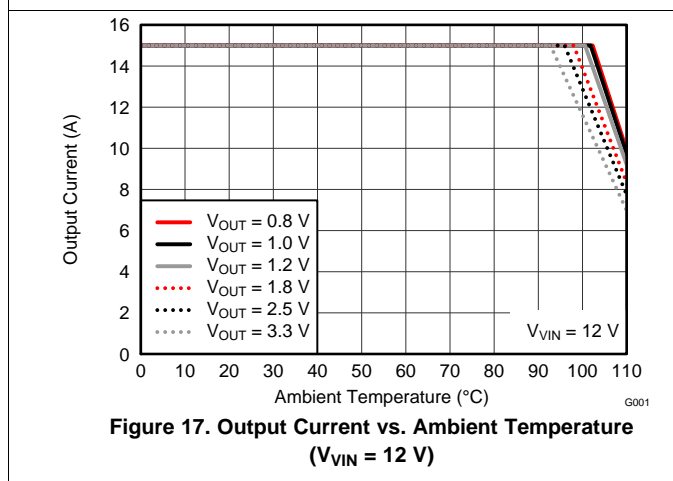
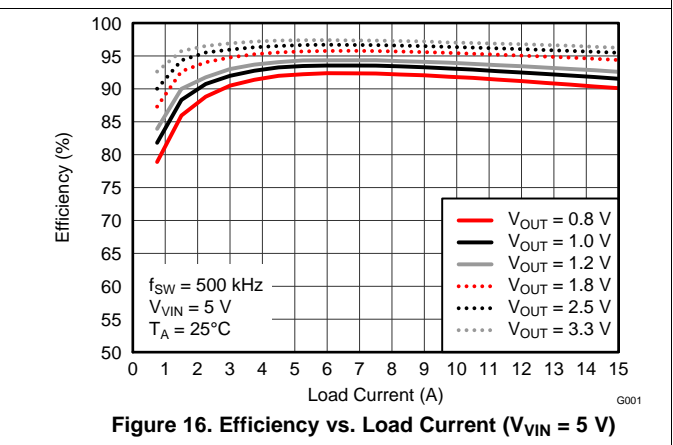
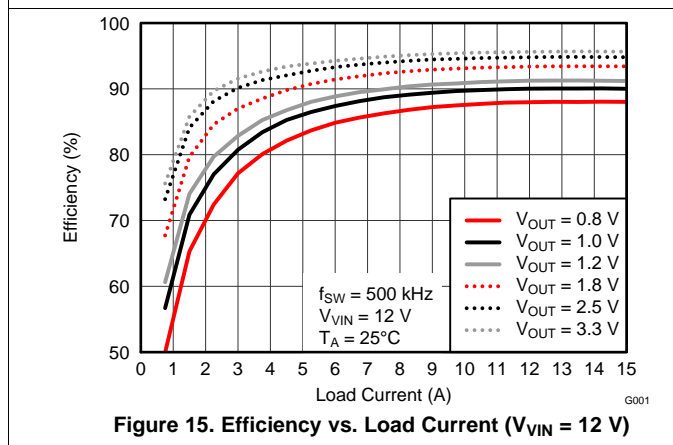
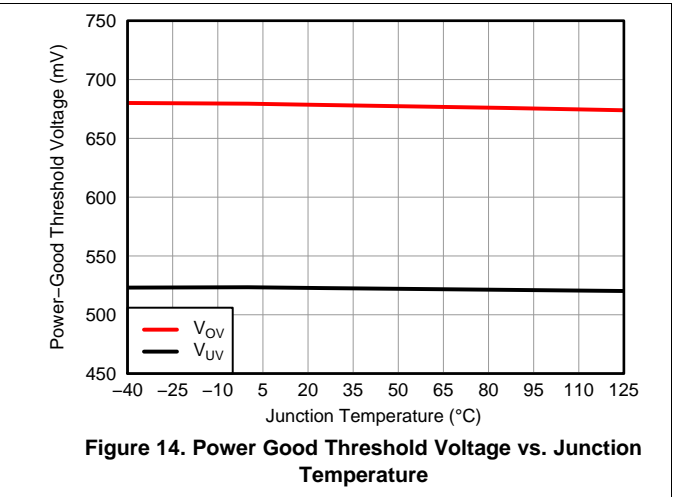
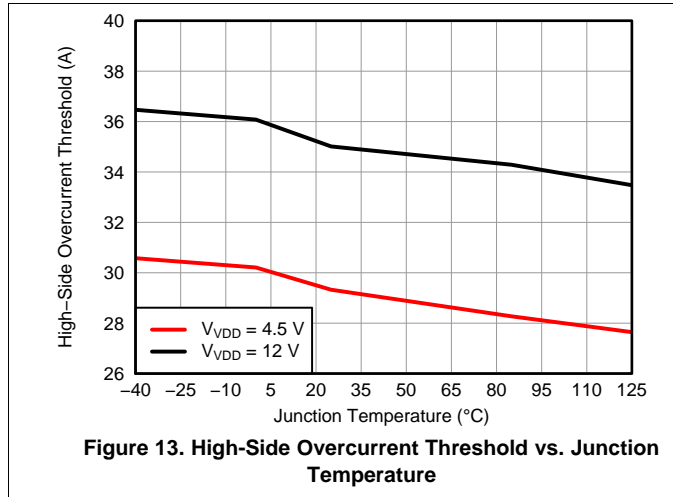

Figure 12. Low-Side On Resistance vs. Junction Temperature

Typical Characteristics (continued)

Figure 15 through Figure 18 are measured on a 2.5-inch x 2.5-inch x 0.062-inch FR4 board with 4 layers and 2 oz. copper, a 0.44- $\mu$ H output inductor and a DCR of 0.32 m $\Omega$ .



## 7 Detailed Description

### 7.1 Overview

The TPS56121 is a 15-A high performance synchronous buck converter with two integrated N-channel NexFET power MOSFETs. The device implements a voltage-mode control with voltage feed-forward compensation that responds instantly to input voltage change. Pre-bias capability eliminates concerns about damaging sensitive loads.

### 7.2 Functional Block Diagram

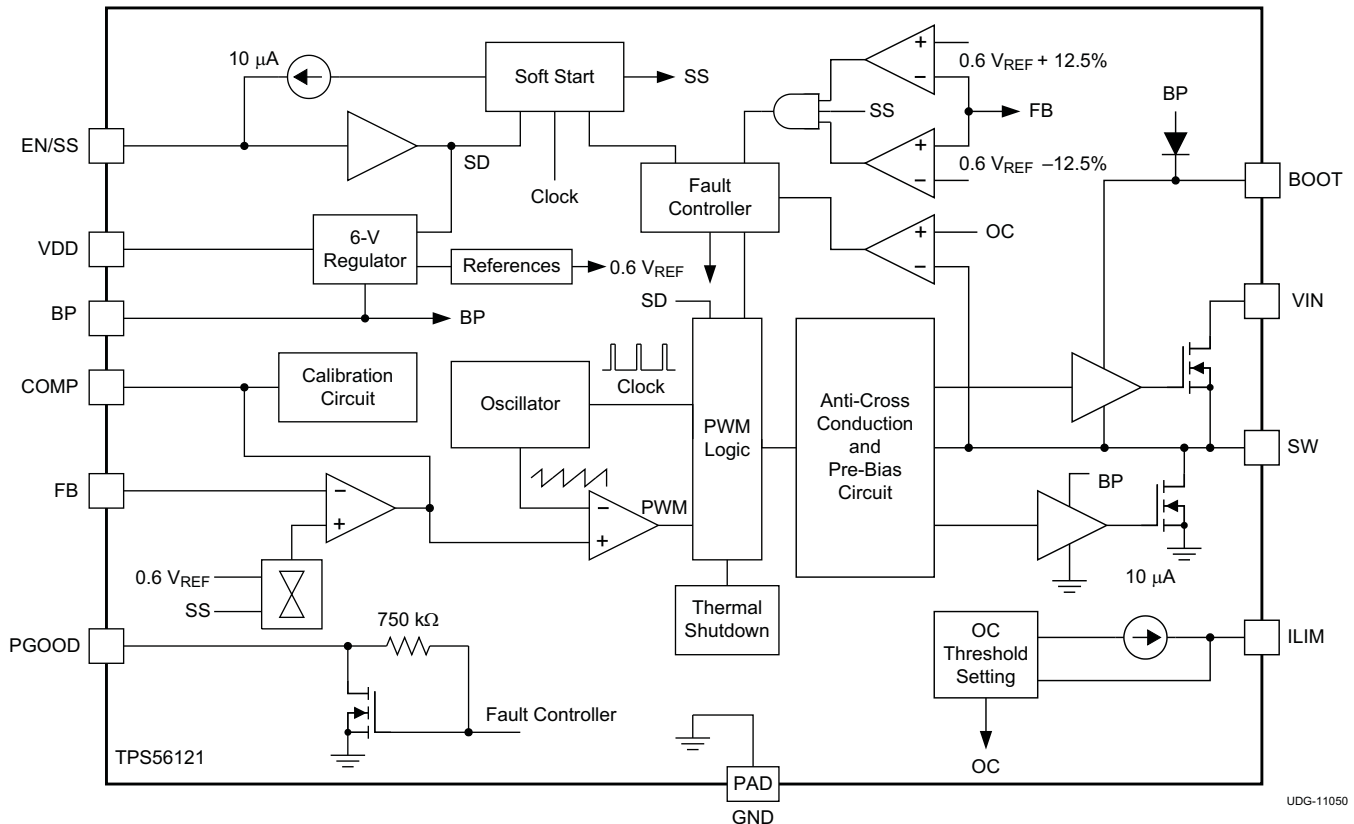

### 7.3 Feature Description

#### 7.3.1 Voltage Reference

The 600-mV bandgap cell is internally connected to the non-inverting input of the error amplifier. The reference voltage is trimmed with the error amplifier in a unity gain configuration to remove amplifier offset from the final regulation voltage. The 1% tolerance on the reference voltage allows the user to design a very accurate power supply.

## Feature Description (continued)

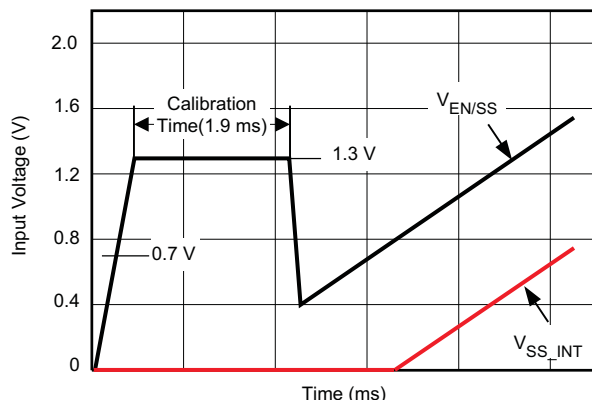

Figure 19. Startup Sequence and Timing

### 7.3.2 Enable Functionality, Startup Sequence and Timing

After input power is applied, an internal 40- $\mu$ A current source begins to charge the soft-start capacitor connected from EN/SS to GND. When the voltage across that capacitor increases to 0.7 V, it enables the internal BP regulator followed by a calibration. Total calibration time is approximately 1.9 ms. See Figure 19. During the calibration, the device performs the following two functions.

#### 7.3.2.1 COMP Pin Impedance Sensing

The device samples the impedance at the COMP pin and determines the appropriate operating switching frequency. If there is no resistor connected from the COMP pin to GND, the switching frequency is set to the default value of 500 kHz. If a resistor of 40.2 k $\Omega$   $\pm$  10% is connected from the COMP pin to GND, the switching frequency is set to 300 kHz. Alternatively, if a resistor of 13.3 K  $\pm$  10% is connected from the COMP pin to GND, the switching frequency is set to 1 MHz.

After a 1.1-ms time period, the COMP pin is then brought low for 0.8 ms. This ensures that the feedback loop is preconditioned at startup and no sudden output rise occurs at the output of the converter when it is allowed to start switching.

#### 7.3.2.2 Overcurrent Protection (OCP) Setting

The device sources 10  $\mu$ A (typical) to the resistor connected from the ILIM pin to GND. The voltage developed across that resistor multiplied by a factor of 2 is then sampled and latched off internally as the OCP trip level for the low-side FET until one cycles the input or toggles the EN/SS.

The voltage at EN/SS is internally clamped to 1.3 V before and/or during calibration to minimize the discharging time once calibration is complete. The discharging current is from an internal current source of 140  $\mu$ A and it pulls the voltage down to 0.4 V. It then initiates the soft-start by charging up the capacitor using an internal current source of 10  $\mu$ A. The resulting voltage ramp on this pin is used as a second non-inverting input to the error amplifier after an 800 mV (typical) downward level-shift; therefore, the actual soft-start does not take place until the voltage at this pin reaches 800 mV.

If the EN/SS pin is left floating, the controller starts automatically. EN/SS must be pulled down to less than 270 mV to ensure that the chip is in shutdown mode.

### 7.3.3 Soft-Start Time

The soft-start time of the TPS56121 is user programmable by selecting a single capacitor. The EN/SS pin sources 10  $\mu$ A to charge this capacitor. The actual output ramp-up time is the amount of time that it takes for the 10  $\mu$ A to charge the capacitor through a 600 mV range. There is some initial lag due to calibration and an offset (800 mV) from the actual EN/SS pin voltage to the voltage applied to the error amplifier.

## Feature Description (continued)

The soft-start is accomplished in a closed-loop, meaning that the error amplifier controls the output voltage at all times during the soft-start period and the feedback loop is never open as occurs in duty cycle limit soft-start schemes. The error amplifier has two non-inverting inputs, one connected to the 600-mV reference voltage, and the other connected to the offset EN/SS pin voltage. The lower of these two voltages is what the error amplifier controls the FB pin to. As the voltage on the EN/SS pin ramps up past approximately 1.4 V (800 mV offset voltage plus the 600 mV reference voltage), the 600-mV reference voltage becomes the dominant input and the converter has reached its final regulation voltage.

The capacitance required for a given soft-start ramp time for the output voltage is calculated in [Equation 1](#).

$$C_{SS} = \left( \frac{I_{SS}}{V_{FB}} \right) \times t_{SS}$$

where

- $C_{SS}$  is the required capacitance on the EN/SS pin (nF)
  - $I_{SS}$  is the soft-start source current (10  $\mu$ A)
  - $V_{FB}$  is the feedback reference voltage (0.6 V)
  - $t_{SS}$  is the desired soft-start ramp time (ms)
- (1)

### 7.3.4 Oscillator

The oscillator frequency is internally fixed at 500 KHz if there is no resistor connected from COMP pin to GND. Optionally, a 40.2-k $\Omega$  resistor from the COMP pin to GND sets the frequency to 300 KHz. Alternatively, a 13.3-k $\Omega$  resistor from COMP pin to GND sets the frequency to 1 MHz.

### 7.3.5 Overcurrent Protection (OCP)

Programmable OCP level at ILIM is from 6 mV to 50 mV. With a scale factor of 2, the actual OC trip point across the low-side FET is in the range of 12 mV to 100 mV.

If the voltage drop across  $R_{OCSET}$  reaches 300 mV during calibration (No  $R_{OCSET}$  resistor included), it disables OC protection. Once disabled, there is no low-side or high-side current sensing.

OCP level for the high-side FET is fixed at 34 A (typical). The high-side OCP provides pulse-by-pulse current limiting.

OCP sensing for the low-side FET is a true inductor valley current detection, using sample and hold. [Equation 2](#) can be used to calculate  $R_{OCSET}$ . Since the TPS56121 is designed for 15-A full-load current and not intentionally designed for an OCP level below 10 A, use an  $R_{OCSET}$  value above 1 k $\Omega$  to get an accurate OCP tripping point.

$$R_{OCSET} = \left( I_{OUT(max)} - \left( \frac{I_{P-P}}{2} \right) \right) \times 95 + 62.5$$

where

- $I_{P-P}$  is the peak-to-peak inductor current (A)
  - $I_{OUT(max)}$  is the trip point for OCP (A)
  - $R_{OCSET}$  is the resistor used for setting the OCP level ( $\Omega$ )
- (2)

An overcurrent (OC) condition is detected by sensing voltage drop across the low-side FET and across the high-side FET. If the voltage drop across either FET exceeds OC threshold, a count increments one count. If no OC condition is detected on either FET, the fault counter decrements by one counter. If three OC pulses are summed, a fault condition is declared which cycles the soft-start function in a hiccup mode. Hiccup mode is defined as four dummy soft-start timeouts followed by a real one if overcurrent condition is encountered during normal operation; or five dummy soft-start timeouts followed by a real one if overcurrent condition occurs from the beginning during start. This cycle continues indefinitely until the fault condition is removed.

## Feature Description (continued)

### 7.3.6 Switching Node (SW)

The SW pin connects to the switching node of the power conversion stage. It acts as the return path for the high-side gate driver. When configured as a synchronous buck stage, the voltage swing on SW normally traverses from below ground to well above the input voltage. Parasitic inductance in the high-side FET and the output capacitance ( $C_{OSS}$ ) of both power FETs form a resonant circuit that can produce high frequency ( $> 100$  MHz) ringing on this node. The voltage peak of this ringing, if not controlled, can be significantly higher than the input voltage. Ensure that the peak ringing amplitude does not exceed the absolute maximum rating limit for the pin.

In many cases, a series resistor and capacitor snubber network connected from the switching node to PGND can be helpful in damping the ringing and decreasing the peak amplitude. Provide provisions for snubber network components in the layout of the printed circuit board. If testing reveals that the ringing amplitude at the SW pin exceeds the limit, then include snubber components.

Placing a BOOT resistor with a value between  $5\ \Omega$  and  $15\ \Omega$  in series with the BOOT capacitor slows down the turn-on of the high-side FET and can help to reduce the peak ringing at the switching node as well.

### 7.3.7 Input Undervoltage Lockout (UVLO)

The TPS56121 has fixed input UVLO. In order for the device to turn on, the following conditions must be met:

- the EN/SS pin voltage must be greater than  $V_{IH}$
- the input voltage must exceed UVLO on voltage  $V_{UVLO}$

The UVLO has a minimum of 500 mV hysteresis built-in.

### 7.3.8 Pre-Bias Startup

The TPS56121 contains a unique circuit to prevent current from being pulled from the output during startup in the condition the output is pre-biased. There are no PWM pulses until the internal soft-start voltage rises above the error amplifier input (FB pin), if the output is pre-biased. Once the soft-start voltage exceeds the error amplifier input, the controller slowly initiates synchronous rectification by starting the synchronous rectifier with a narrow on time. It then increments the on-time on a cycle-by-cycle basis until it coincides with the time dictated by  $(1-D)$ , where D is the duty cycle of the converter.

This approach prevents the sinking of current from a pre-biased output, and ensures the output voltage startup and ramp to regulation is smooth and controlled.

### 7.3.9 Power Good

The TPS56121 provides an indication that output is good for the converter. This is an open drain signal and pulls low when any condition exists that would indicate that the output of the supply might be out of regulation. These conditions include:

- $V_{FB}$  is more than  $\pm 12.5\%$  from nominal
- soft-start is active
- a short circuit condition has been detected

---

#### NOTE

When there is no power to the device, PGOOD is not able to pull close to GND if an auxiliary supply is used for the power good indication. In this case, a built in resistor connected from drain to gate on the PGOOD pull down device makes the PGOOD pin look approximately like a diode to GND.

---

### 7.3.10 Thermal Shutdown

If the junction temperature of the device reaches the thermal shutdown limit of  $145^{\circ}\text{C}$ , both the high-side FET and low-side FET maintain off status. When the junction cools to the required level ( $125^{\circ}\text{C}$  typical), the PWM initiates soft start as during a normal power-up cycle.

## 7.4 Device Functional Modes

The TPS56121 devices operate in continuous conduction mode (CCM) at a fixed frequency, regardless of the output current. For the first 128 switching cycles, the low-side MOSFET on-time is slowly increased to prevent excessive current sinking in the event the device is started with a prebiased output. Following the first 128 switching cycles, the low-side MOSFET and the high-side MOSFET on-times are fully complementary.

## 8 Application and Implementation

### NOTE

Information in the following applications sections is not part of the TI component specification, and TI does not warrant its accuracy or completeness. TI's customers are responsible for determining suitability of components for their purposes. Customers should validate and test their design implementation to confirm system functionality.

### 8.1 Application Information

The TPS56121 is a highly-integrated synchronous step-down DC-DC converter. It is used to convert a higher DC input voltage (4.5 V to 14 V recommended) to a lower DC output voltage (as low as 0.6 V), with a maximum output current of 15 A, for a variety of applications.

### 8.2 Typical Application

This design example describes a 15-A, 12-V to 1.0-V design using the TPS56121 high-current integrated buck converter. The system specifications are listed in Table 1. Use the following design procedure to select key component values for this device.

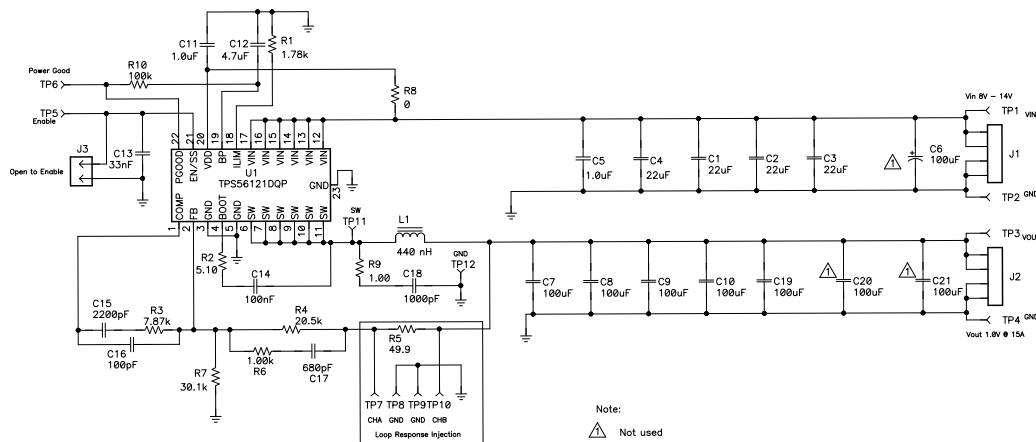

Figure 20. Design Example Schematic

#### 8.2.1 Design Requirements

Table 1. TPS56121 Design Example Parameters

PARAMETER	TEST CONDITIONS	MIN	TYP	MAX	UNIT			
V <sub>IN</sub>	Input voltage	8	12	14	V			
V <sub>IN(ripple)</sub>	Input ripple	I <sub>OUT</sub> = 15 A			0.15	V		
V <sub>OUT</sub>	Output voltage	0 A ≤ I <sub>OUT</sub> ≤ 15 A			0.98	1.00	1.02	V
	Line regulation	8 V ≤ V <sub>IN</sub> ≤ 14 V			0.1%			
	Load regulation	0 A ≤ I <sub>OUT</sub> ≤ 15 A			0.5%			
V <sub>RIPPLE</sub>	Output ripple	I <sub>OUT</sub> = 15 A			20	mV		
V <sub>OVER</sub>	Output overshoot	I <sub>TRAN</sub> = 5 A			50	mV		
V <sub>UNDER</sub>	Output undershoot	I <sub>TRAN</sub> = 5 A			50	mV		
I <sub>OUT</sub>	Output current	8 V ≤ V <sub>IN</sub> ≤ 14 V			0	15	A	
t <sub>SS</sub>	Soft-start time	V <sub>IN</sub> = 12 V			2.0	ms		
I <sub>OUT(max)</sub>	Short-circuit current trip point				20	A		
η	Efficiency	V <sub>IN</sub> = 12 V, I <sub>OUT</sub> = 15 A			90%			
f <sub>SW</sub>	Switching frequency				500	kHz		

## 8.2.2 Detailed Design Procedure

**Table 2. List of Materials for TPS56121 Design Example**

REFERENCE DESIGNATOR	QTY	VALUE	DESCRIPTION	SIZE	PART NUMBER	MANUFACTURER
C1, C2, C3, C4	4	22 $\mu$ F	Capacitor, Ceramic, 25 V, X5R, 20%	1210	Std	Std
C5, C11	2	1.0 $\mu$ F	Capacitor, Ceramic, 25V, X7R, 20%	0805	Std	Std
C6	0	100 $\mu$ F	Capacitor, Aluminum, 16 VDC, $\pm$ 20%	Code D8	EEEEFP1C101AP	Panasonic
C7, C8, C9, C10, C19	5	100 $\mu$ F	Capacitor, Ceramic, 6.3V, X5R, 20%	1210	Std	Std
C12	1	4.7 $\mu$ F	Capacitor, Ceramic, 10 V, X5R, 20%	0805	Std	Std
C13	1	33 nF	Capacitor, Ceramic, 16 V, X7R, 20%	0603	Std	Std
C14	1	100 nF	Capacitor, Ceramic, 50 V, X7R, 20%	0603	Std	Std
C15	1	2200 pF	Capacitor, Ceramic, 50 V, X7R, 10%	0603	Std	Std
C16	1	100 pF	Capacitor, Ceramic, 50 V, C0G, 5%	0603	Std	Std
C17	1	680 pF	Capacitor, Ceramic, 50 V, C0G, 5%	0603	Std	Std
C18	1	1000 pF	Capacitor, Ceramic, 50 V, X7R, 20%	0603	Std	Std
C20, C21	0	100 $\mu$ F	Capacitor, Ceramic, 6.3 V, X5R, 20%	1210	Std	Std
J1, J2	2		Terminal Block, 4-pin, 15 A, 5.1 mm	0.80 x 0.35 inch	ED120/4DS	OST
J3	1		Header, Male 2-pin, 100mil spacing	0.100 inch x $\frac{1}{2}$	PEC02SAAN	Sullins
L1	1	440 nH	Inductor, 440 nH, 30A, 0.32 m $\Omega$	0.530 x 0.510 inch	PA0513.441NLT	Pulse
R1	1	1.78 k $\Omega$	Resistor, Chip, 1/16W, 1%	0603	Std	Std
R2	1	5.10 $\Omega$	Resistor, Chip, 1/16W, 1%	0603	Std	Std
R3	1	7.87 k $\Omega$	Resistor, Chip, 1/16W, 1%	0603	Std	Std
R4	1	20.5 k $\Omega$	Resistor, Chip, 1/16W, 1%	0603	Std	Std
R5	1	49.9 $\Omega$	Resistor, Chip, 1/16W, 1%	0603	Std	Std
R6	1	1.00 k $\Omega$	Resistor, Chip, 1/16W, 1%	0603	Std	Std
R7	1	30.1 k $\Omega$	Resistor, Chip, 1/16W, 1%	0603	Std	Std
R8	1	0 $\Omega$	Resistor, Chip, 1/16 W, 1%	0603	Std	Std
R9	1	1.00 $\Omega$	Resistor, Chip, 1/8 W, 1%	0805	Std	Std
R10	1	100 k $\Omega$	Resistor, Chip, 1/16W, 1%	0603	Std	Std
TP1, TP3, TP11	3		Test Point, Red, Thru Hole	0.125 x 0.125 inch	5010	Keystone
TP2, TP4, TP8, TP9, TP12	5		Test Point, Black, Thru Hole	0.125 x 0.125 inch	5011	Keystone
TP5, TP6	2		Test Point, Yellow, Thru Hole	0.125 x 0.125 inch	5014	Keystone
TP7, TP10	2		Test Point, White, Thru Hole	0.125 x 0.125 inch	5012	Keystone
U1	1		4.5-V to 14-V input, 15-A, synchronous buck converter	QFN-22 6 x 5 mm	TPS56121DQP	TI

### 8.2.2.1 Switching Frequency Selection

To achieve a balance between small size and high efficiency for this design, use switching frequency of 500 kHz.

### 8.2.2.2 Inductor Selection (L1)

Synchronous buck power inductors are typically sized for between approximately 20% and 40% peak-to-peak ripple current ( $I_{P-P}$ ).

Using this target ripple current, the required inductor size can be calculated as shown in [Equation 3](#).

$$L \approx \frac{V_{IN(max)} - V_{OUT}}{0.3 \times I_{OUT}} \times \frac{V_{OUT}}{V_{IN(max)}} \times \frac{1}{f_{SW}} = \frac{14V - 1.0V}{0.3 \times 15A} \times \frac{1.0V}{14V} \times \frac{1}{500kHz} = 413nH \quad (3)$$

Selecting a standard 440-nH inductor value,  $I_{P-P} = 4.2A$ .

The RMS current through the inductor is approximated in [Equation 4](#).

$$I_{L(rms)} = \sqrt{(I_{OUT})^2 + \left(\frac{1}{12} \times (I_{P-P})^2\right)} = \sqrt{(15)^2 + \left(\frac{1}{12} \times (4.2)^2\right)} = 15.05A \quad (4)$$

### 8.2.2.3 Output Capacitor Selection

The output transient response typically drives the selection of the output capacitor. For applications where  $V_{IN(min)} > 2 \times V_{OUT}$ , use overshoot to calculate the minimum output capacitance, as shown in [Equation 5](#).

$$C_{OUT(min)} = \frac{(I_{TRAN})^2 \times L}{(V_{OUT} \times V_{OVER})} = \frac{5^2 \times 440nH}{1.0 \times 50mV} = 220\mu F \quad (5)$$

For applications where  $V_{IN(min)} < 2 \times V_{OUT}$ , use overshoot to calculate the minimum output capacitance. The equation is shown in [Equation 6](#)

$$C_{OUT(min)} = \frac{(I_{TRAN})^2 \times L}{(V_{IN} - V_{OUT}) \times V_{UNDER}} \quad (6)$$

In order to meet the low ESR and high capacitance requirements, this design uses five 100- $\mu F$ , 1210 ceramic capacitors. With a minimum capacitance, maximum ripple voltage determines the maximum allowable ESR. The ESR is approximated in [Equation 7](#).

$$ESR_{COUT(max)} = \frac{V_{RIPPLE} - V_{RIPPLE(COUT)}}{I_{P-P}} = \frac{V_{RIPPLE} - \left(\frac{I_{P-P}}{8 \times C_{OUT} \times f_{SW}}\right)}{I_{P-P}} = \frac{20mV - \left(\frac{4.2A}{8 \times 500\mu F \times 500kHz}\right)}{4.2A} = 4.3m\Omega \quad (7)$$

### 8.2.2.4 Inductor Peak Current Rating

With output capacitance, it is possible to calculate the charge current during start-up and determine the minimum saturation current rating for the inductor. [Equation 8](#) approximates the start-up charging current ( $I_{CHARGE}$ ).

$$I_{CHARGE} = \frac{V_{OUT} \times C_{OUT}}{t_{SS}} = \frac{1.0V \times 500\mu F}{2ms} = 0.25A \quad (8)$$

[Equation 9](#) approximates the peak current in the inductor,  $I_{L(peak)}$ .

$$I_{L(peak)} = I_{OUT} + \left(\frac{1}{2} \times I_{RIPPLE}\right) + I_{CHARGE} = 15A + \left(\frac{1}{2} \times 4.2A\right) + 0.25A = 17.4A \quad (9)$$

With the short circuit current trip point  $I_{OUT(max)}$  set at 20 A, the maximum allowable peak current  $I_{L\_PEAK(max)}$  is shown in [Equation 10](#).

$$I_{L\_PEAK(max)} = I_{OUT(max)} + \left(\frac{1}{2} \times I_{RIPPLE}\right) = 20A + \left(\frac{1}{2} \times 4.2A\right) = 22.1A \quad (10)$$

The selection of output capacitor meets the maximum allowable peak current requirement.

**Table 3. Inductor Requirements Summary**

PARAMETER		VALUE	UNIT
L	Inductance	440	nH
$I_{L(rms)}$	RMS current (thermal rating)	15.1	A
$I_{L\_PEAK(max)}$	Peak current (saturation rating)	22.1	A

This design uses a PA0513.441NLT, 440-nH, 0.32-mΩ, 30-A inductor.

### 8.2.2.5 Input Capacitor Selection

The input voltage ripple is divided between capacitance and ESR. For this design  $V_{IN\_RIPPLE(CAP)} = 100$  mV and  $V_{IN\_RIPPLE(ESR)} = 50$  mV. Use [Equation 11](#) to estimate the minimum capacitance. Use [Equation 12](#) to estimate the maximum ESR.

$$C_{IN(min)} = \frac{I_{OUT} \times V_{OUT} \times (V_{IN(min)} - V_{OUT})}{V_{IN\_RIPPLE(CAP)} \times (V_{IN(min)})^2 \times f_{SW}} = \frac{15 \times 1.0 \text{ V} \times (8 \text{ V} - 1.0 \text{ V})}{100 \text{ mV} \times (8 \text{ V})^2 \times 500 \text{ kHz}} = 32.8 \mu\text{F} \quad (11)$$

$$ESR_{CIN(max)} = \frac{V_{IN\_RIPPLE(ESR)}}{I_{OUT} + \left(\frac{I_{P-P}}{2}\right)} = \frac{50 \text{ mV}}{15 \text{ A} + \left(\frac{4.2 \text{ A}}{2}\right)} = 2.9 \text{ m}\Omega \quad (12)$$

[Equation 13](#) estimates the RMS current in the input capacitors.

$$I_{RMS(cin)} = I_{OUT} \times \sqrt{D_{MAX} \times (1 - D_{MAX})} = 15 \text{ A} \times \sqrt{\frac{1}{8} \times \left(1 - \frac{1}{8}\right)} = 5.0 \text{ A}_{rms} \quad (13)$$

Four 1210, 22-μF, 25-V, X5R, ceramic capacitors with approximately 2.5-mΩ ESR and a 2.5-A RMS current rating are selected. Higher voltage capacitors are selected to minimize capacitance loss at the DC bias voltage to ensure the capacitors will have sufficient capacitance at the working voltage while a 1.0-μF capacitor in smaller case size is used to reduce high frequency noise from the MOSFET switching.

### 8.2.2.6 Bootstrap Capacitor (C14)

The bootstrap capacitor maintains power to the high-side driver during the high-side switch ON time. Per the requirements of the integrated MOSFET, the value of  $C_{BOOT}$  is 100 nF with a minimum 10-V rating.

### 8.2.2.7 Bootstrap Resistor (R2)

The bootstrap resistor slows the rising edge of the SW voltage to reduce ringing and improve EMI. Per the datasheet recommendation a 5.1-Ω resistor is selected.

### 8.2.2.8 RC Snubber (R9 and C18)

To effectively limit the switch node ringing, select a 1.0-Ω resistor and a 1000-pF capacitor

### 8.2.2.9 VDD Bypass Capacitor (C11)

Per the data sheet recommended pin terminations, bypass VDD to GND with a 1.0-μF capacitor.

### 8.2.2.10 BP5 Bypass Capacitor (C12)

Per the data sheet recommended pin functions, bypass BP5 to GND with a capacitor with a value of at least 1.0-μF. For additional filtering and noise immunity, select a 4.7-μF capacitor.

### 8.2.2.11 Soft-Start Capacitor (C13)

The soft-start capacitor provides a constant ramp voltage to the error amplifier to provide controlled, smooth start-up. The soft-start capacitor is sized using [Equation 14](#).

$$C_{SS} = \frac{I_{SS}}{V_{FB}} \times t_{SS} = \frac{10 \mu\text{A}}{0.6 \text{ V}} \times 2.0 \text{ ms} = 33 \text{ nF} \quad (14)$$

### 8.2.2.12 Current Limit (R1)

The TPS56221 uses the negative drop across the internal low-side FET at the end of the OFF-time to measure the valley of the inductor current. Allowing for a minimum 20-A, or 30% over maximum load, the programming resistor is selected using [Equation 15](#).

$$R_{OCSET} = 95 \times \left( I_{OUT(max)} - \left( \frac{I_{P-P}}{2} \right) \right) + 62.5 \, \Omega = 95 \times \left( 20 \, A - \left( \frac{4.2 \, A}{2} \right) \right) + 62.5 \, \Omega = 1.76 \, k\Omega \quad (15)$$

Select a standard 1.78-k $\Omega$  resistor from the E-48 series.

### 8.2.2.13 Feedback Divider (R4, R7)

The TPS56121 converter uses a full operational amplifier with an internally fixed 0.600-V reference. R4 is selected between 10 k $\Omega$  and 50 k $\Omega$  for a balance of feedback current and noise immunity. With R4 set to 20.5 k $\Omega$ , program the output voltage with a resistor divider as calculated in [Equation 16](#).

$$R7 = \frac{V_{FB} \times R4}{(V_{OUT} - V_{FB})} = \frac{0.600 \, V \times 20.5 \, k\Omega}{(1.0 \, V - 0.600 \, V)} = 30.8 \, k\Omega \quad (16)$$

Select a standard 30.1-k $\Omega$  resistor from the E-48 series.

### 8.2.2.14 Compensation (C15, C16, C17, R3, R6)

Using the *TPS40k Loop Stability Tool* for 50 kHz of bandwidth and 60 degrees of phase margin with an R4 value of 20.5 k $\Omega$ , the design yields the following values.

- C17 = C\_1 = 680 pF
- C15 = C\_2 = 2200 pF
- C16 = C\_3 = 100 pF
- R6 = R\_2 = 1.00 k $\Omega$
- R3 = R\_3 = 7.87 k $\Omega$

TPS56121

SLUSAH4D – MARCH 2011 – REVISED FEBRUARY 2016

www.ti.com

8.2.3 Application Curves

Output voltage 12 V to 1.0 V at 0-A to 15-A input current.

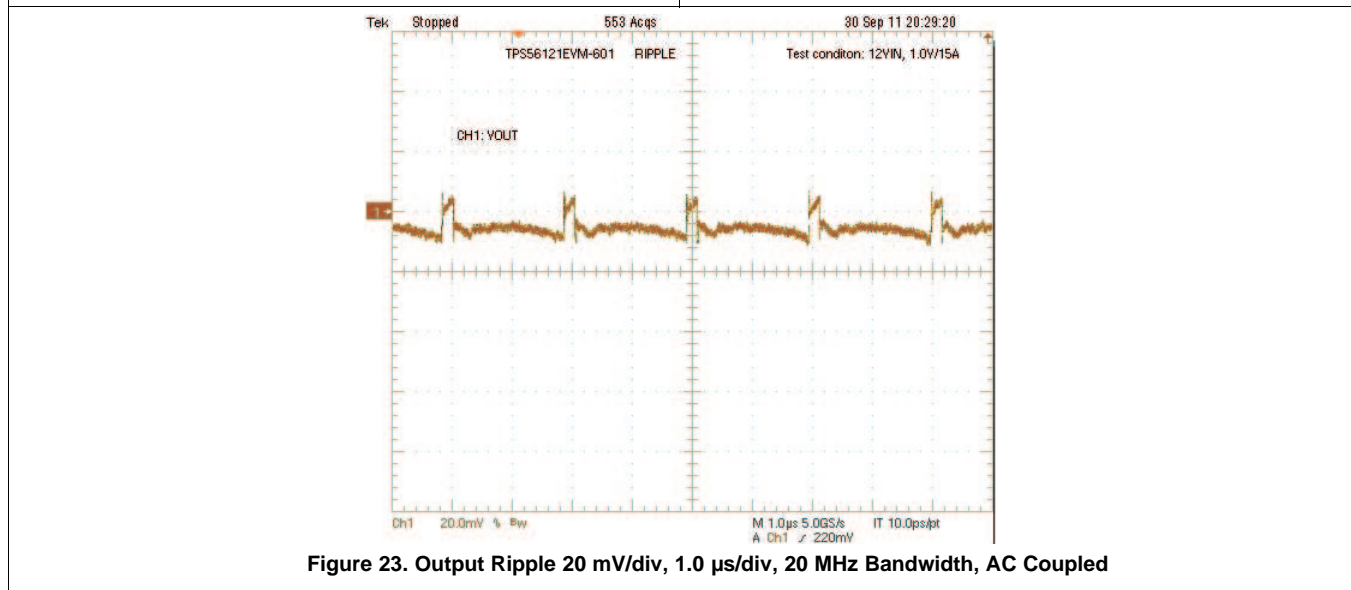
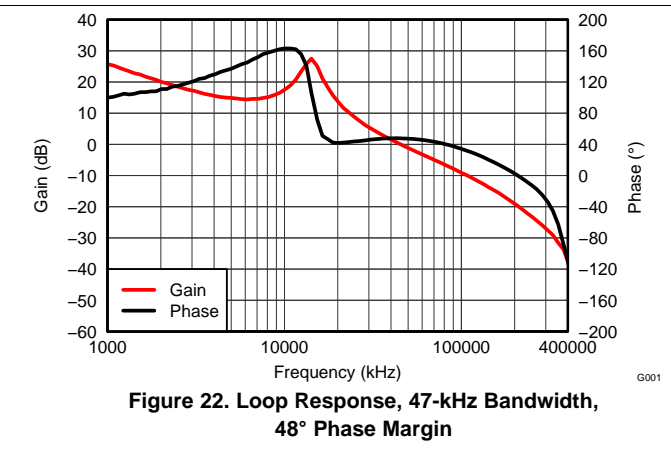
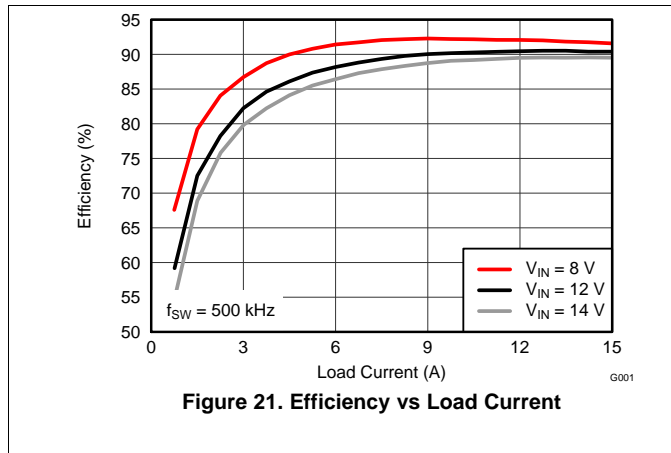

## 9 Power Supply Recommendations

The TPS56121 devices are designed to operate from an input voltage supply between 4.5 V and 14 V. This supply must be well regulated. These devices are not designed for split-rail operation. The VIN and VDD terminals must be the same potential for accurate high-side short circuit protection. Proper bypassing of input supplies and internal regulators is also critical for noise performance, as is PCB layout and grounding scheme. See the recommendations in [Layout Guidelines](#).

## 10 Layout

### 10.1 Layout Guidelines

- Place input capacitors next to the VIN pin and on the same side as the device. Use wide and short traces or copper planes for the connection from the VIN pin to the input capacitor and from the input capacitor to the power pad of the device.
- Place the BP decoupling capacitor close to the BP pin and on the same side as the device in order to avoid the use of vias. Use wide and short traces for the connection from the BP pin to the capacitor and from the capacitor to the power pad. If vias are not evitable, use at least three vias to reduce the parasitic inductance.
- Include a Kelvin VDD connection, or separate from VIN connection (bypass input capacitors); add a placeholder for a filter resistor between the VDD pin and the input bus. Place the VDD decoupling capacitor near the VDD pin and on the same side as the device to avoid the use of vias. Use wide and short traces for the connection from the VDD pin to the capacitor and from the capacitor to the power pad of the device. If vias are not avoidable, use at least three vias to reduce the parasitic inductance.
- Maintain the FB trace away from BOOT and SW traces.
- Minimize the area of switch node.
- Use a single ground. Do not use separate signal and power ground.
- Use 3 × 7 thermal vias as suggested in *Land Pattern Data* in [Mechanical, Packaging, and Orderable Information](#).

### 10.2 Layout Example

The TPS56121EVM-601 layout is shown in [Figure 24](#) through [Figure 29](#) for reference.

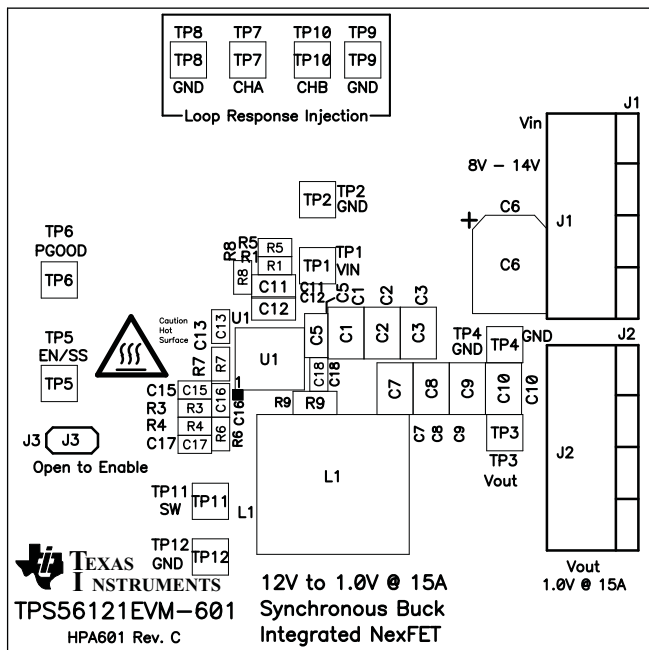

Figure 24. TPS56121EVM-601 Top Assembly Drawing (Top view)

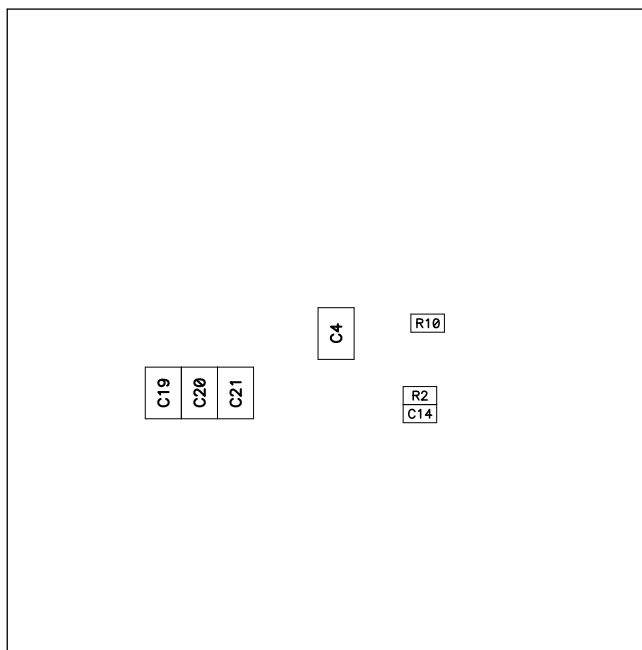
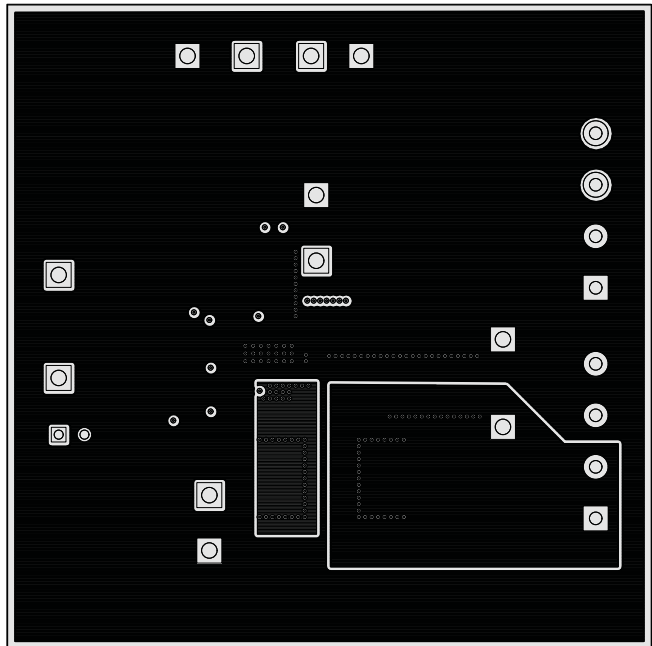
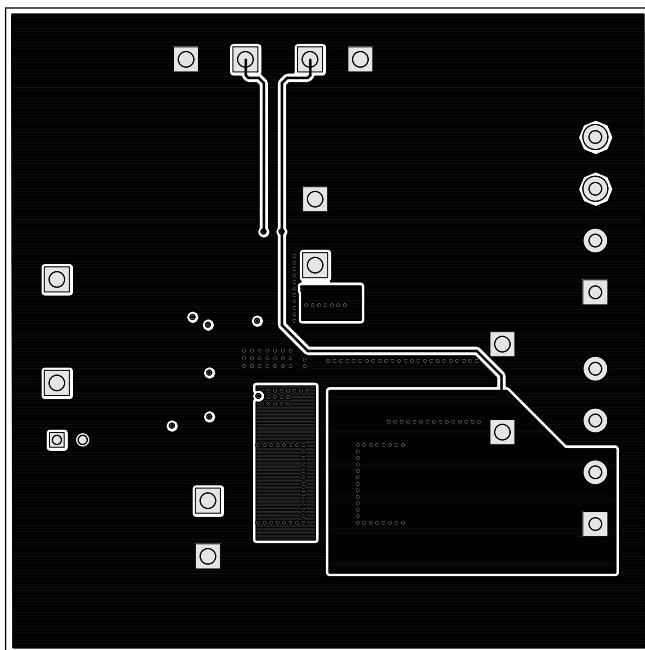
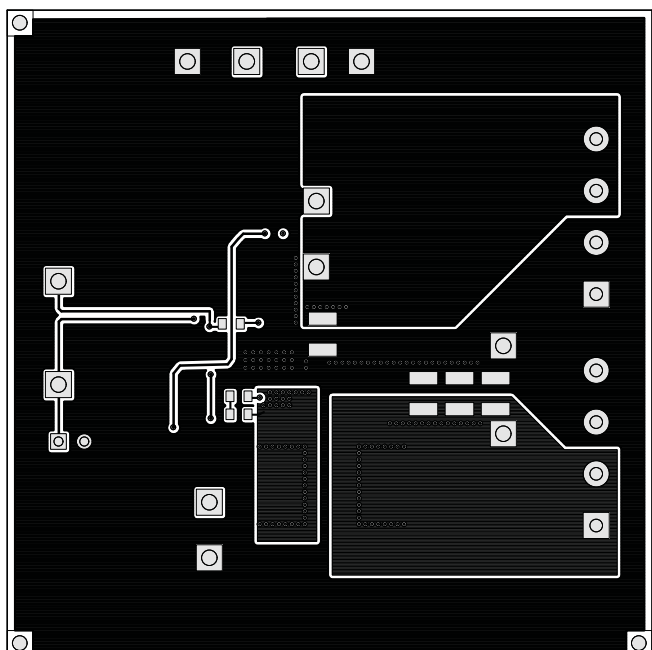

Figure 25. TPS56121EVM-601 Bottom Assembly Drawing (Bottom view)

**Layout Example (continued)**

**Figure 26. TPS56121EVM-601 Top Copper (Top View)**

**Figure 27. TPS56121EVM-601 Internal 1 (Top View)**

**Figure 28. TPS56121EVM-601 Internal 2 (Top View)**

**Figure 29. TPS56121EVM-601 Bottom Copper (Top View)**

## 11 Device and Documentation Support

### 11.1 Device Support

#### 11.1.1 Third-Party Products Disclaimer

TI'S PUBLICATION OF INFORMATION REGARDING THIRD-PARTY PRODUCTS OR SERVICES DOES NOT CONSTITUTE AN ENDORSEMENT REGARDING THE SUITABILITY OF SUCH PRODUCTS OR SERVICES OR A WARRANTY, REPRESENTATION OR ENDORSEMENT OF SUCH PRODUCTS OR SERVICES, EITHER ALONE OR IN COMBINATION WITH ANY TI PRODUCT OR SERVICE.

#### 11.2 Trademarks

PowerPAD, SWIFT, NexFET are trademarks of Texas Instruments.  
All other trademarks are the property of their respective owners.

#### 11.3 Electrostatic Discharge Caution



These devices have limited built-in ESD protection. The leads should be shorted together or the device placed in conductive foam during storage or handling to prevent electrostatic damage to the MOS gates.

#### 11.4 Glossary

[SLYZ022](#) — *TI Glossary*.

This glossary lists and explains terms, acronyms, and definitions.

## 12 Mechanical, Packaging, and Orderable Information

The following pages include mechanical, packaging, and orderable information. This information is the most current data available for the designated devices. This data is subject to change without notice and revision of this document. For browser-based versions of this data sheet, refer to the left-hand navigation.

**PACKAGING INFORMATION**

Orderable Device	Status (1)	Package Type	Package Drawing	Pins	Package Qty	Eco Plan (2)	Lead finish/ Ball material (6)	MSL Peak Temp (3)	Op Temp (°C)	Device Marking (4/5)	Samples
TPS56121DQPR	ACTIVE	LSON-CLIP	DQP	22	2500	RoHS-Exempt & Green	NIPDAU   SN	Level-2-260C-1 YEAR	-40 to 125	TPS56121	<a href="#">Samples</a>
TPS56121DQPT	ACTIVE	LSON-CLIP	DQP	22	250	RoHS-Exempt & Green	NIPDAU   SN	Level-2-260C-1 YEAR	-40 to 125	TPS56121	<a href="#">Samples</a>

(1) The marketing status values are defined as follows:

**ACTIVE:** Product device recommended for new designs.

**LIFEBUY:** TI has announced that the device will be discontinued, and a lifetime-buy period is in effect.

**NRND:** Not recommended for new designs. Device is in production to support existing customers, but TI does not recommend using this part in a new design.

**PREVIEW:** Device has been announced but is not in production. Samples may or may not be available.

**OBSOLETE:** TI has discontinued the production of the device.

(2) **RoHS:** TI defines "RoHS" to mean semiconductor products that are compliant with the current EU RoHS requirements for all 10 RoHS substances, including the requirement that RoHS substance do not exceed 0.1% by weight in homogeneous materials. Where designed to be soldered at high temperatures, "RoHS" products are suitable for use in specified lead-free processes. TI may reference these types of products as "Pb-Free".

**RoHS Exempt:** TI defines "RoHS Exempt" to mean products that contain lead but are compliant with EU RoHS pursuant to a specific EU RoHS exemption.

**Green:** TI defines "Green" to mean the content of Chlorine (Cl) and Bromine (Br) based flame retardants meet JS709B low halogen requirements of <=1000ppm threshold. Antimony trioxide based flame retardants must also meet the <=1000ppm threshold requirement.

(3) MSL, Peak Temp. - The Moisture Sensitivity Level rating according to the JEDEC industry standard classifications, and peak solder temperature.

(4) There may be additional marking, which relates to the logo, the lot trace code information, or the environmental category on the device.

(5) Multiple Device Markings will be inside parentheses. Only one Device Marking contained in parentheses and separated by a "~" will appear on a device. If a line is indented then it is a continuation of the previous line and the two combined represent the entire Device Marking for that device.

(6) Lead finish/Ball material - Orderable Devices may have multiple material finish options. Finish options are separated by a vertical ruled line. Lead finish/Ball material values may wrap to two lines if the finish value exceeds the maximum column width.

**Important Information and Disclaimer:**The information provided on this page represents TI's knowledge and belief as of the date that it is provided. TI bases its knowledge and belief on information provided by third parties, and makes no representation or warranty as to the accuracy of such information. Efforts are underway to better integrate information from third parties. TI has taken and continues to take reasonable steps to provide representative and accurate information but may not have conducted destructive testing or chemical analysis on incoming materials and chemicals. TI and TI suppliers consider certain information to be proprietary, and thus CAS numbers and other limited information may not be available for release.

In no event shall TI's liability arising out of such information exceed the total purchase price of the TI part(s) at issue in this document sold by TI to Customer on an annual basis.



**TAPE AND REEL INFORMATION**

**QUADRANT ASSIGNMENTS FOR PIN 1 ORIENTATION IN TAPE**

\*All dimensions are nominal

Device	Package Type	Package Drawing	Pins	SPQ	Reel Diameter (mm)	Reel Width W1 (mm)	A0 (mm)	B0 (mm)	K0 (mm)	P1 (mm)	W (mm)	Pin1 Quadrant
TPS56121DQPR	LSON-CLIP	DQP	22	2500	330.0	12.4	5.3	6.3	1.8	8.0	12.0	Q1
TPS56121DQPT	LSON-CLIP	DQP	22	250	330.0	15.4	5.3	6.3	1.8	8.0	12.0	Q1
TPS56121DQPT	LSON-CLIP	DQP	22	250	180.0	12.4	5.3	6.3	1.8	8.0	12.0	Q1

**TAPE AND REEL BOX DIMENSIONS**

\*All dimensions are nominal

Device	Package Type	Package Drawing	Pins	SPQ	Length (mm)	Width (mm)	Height (mm)
TPS56121DQPR	LSON-CLIP	DQP	22	2500	346.0	346.0	33.0
TPS56121DQPT	LSON-CLIP	DQP	22	250	336.6	336.6	41.3
TPS56121DQPT	LSON-CLIP	DQP	22	250	210.0	185.0	35.0

DQP (R-PSON-N22)

PLASTIC SMALL OUTLINE NO-LEAD

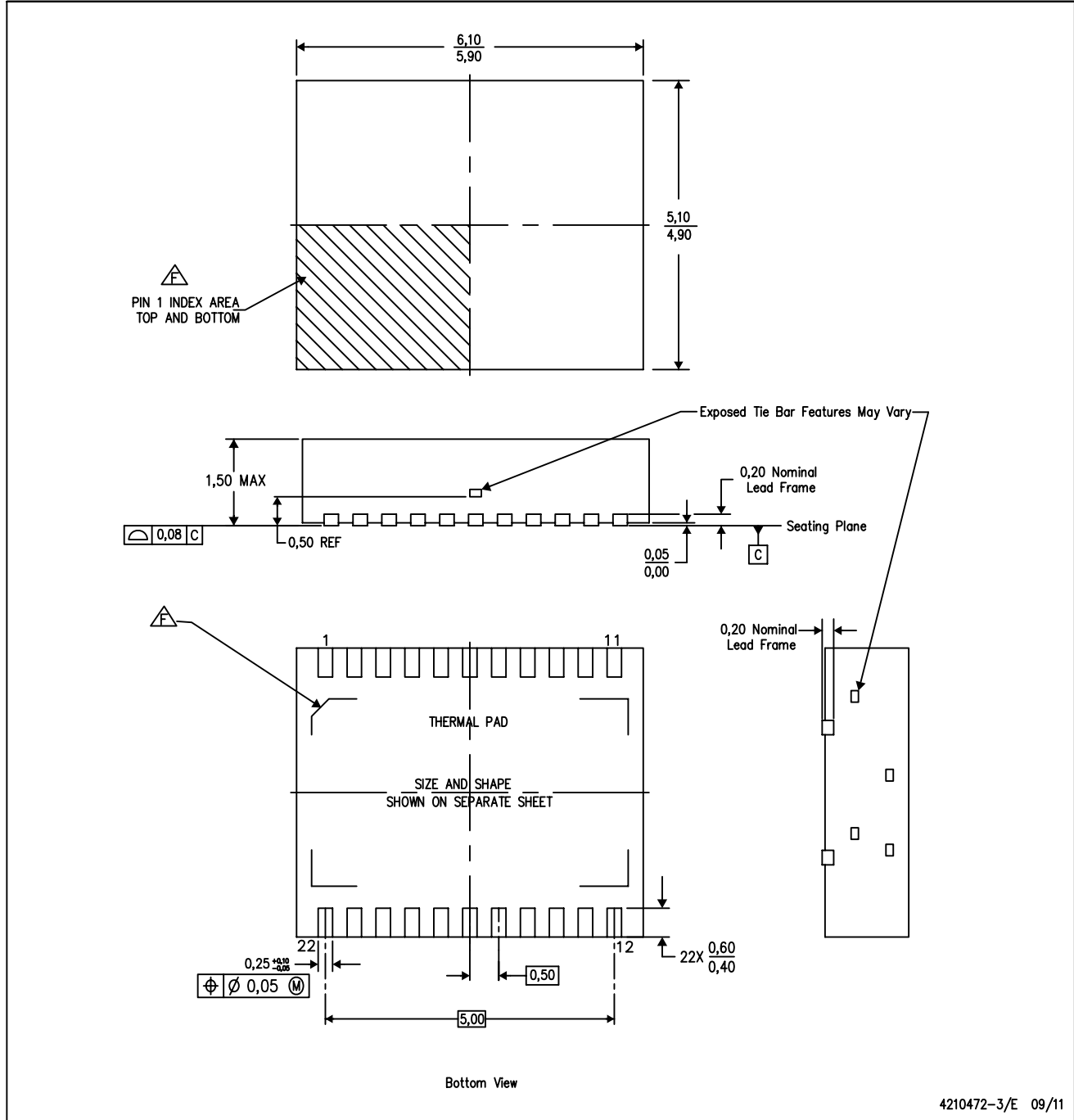

- NOTES:
- All linear dimensions are in millimeters. Dimensioning and tolerancing per ASME Y14.5M-1994.
  - This drawing is subject to change without notice.
  - Small Outline No-Lead (SON) package configuration.
  - The package thermal pad must be soldered to the board for thermal and mechanical performance.
  - See the additional figure in the Product Data Sheet for details regarding the exposed thermal pad features and dimensions.
- △ Pin 1 identifiers are located on both top and bottom of the package and within the zone indicated. The Pin 1 identifiers are either a molded, marked, or metal feature.

# THERMAL PAD MECHANICAL DATA

DQP (R-PSO-N22)

PLASTIC SMALL OUTLINE NO-LEAD

## THERMAL INFORMATION

This package incorporates an exposed thermal pad that is designed to be attached directly to an external heatsink. The thermal pad must be soldered directly to the printed circuit board (PCB). After soldering, the PCB can be used as a heatsink. In addition, through the use of thermal vias, the thermal pad can be attached directly to the appropriate copper plane shown in the electrical schematic for the device, or alternatively, can be attached to a special heatsink structure designed into the PCB. This design optimizes the heat transfer from the integrated circuit (IC).

For information on the Quad Flatpack No-Lead (QFN) package and its advantages, refer to Application Report, QFN/SO-N PCB Attachment, Texas Instruments Literature No. SLUA271. This document is available at [www.ti.com](http://www.ti.com).

The exposed thermal pad dimensions for this package are shown in the following illustration.

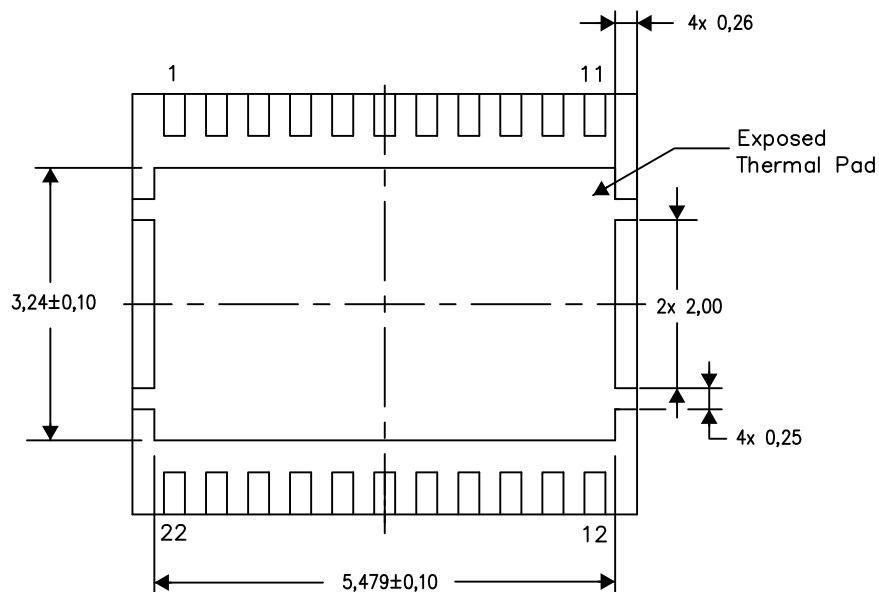

Bottom View

Exposed Thermal Pad Dimensions

4211024-3/H 08/15

NOTE: All linear dimensions are in millimeters

DQP (R-PSO-N22)

PLASTIC SMALL OUTLINE NO-LEAD

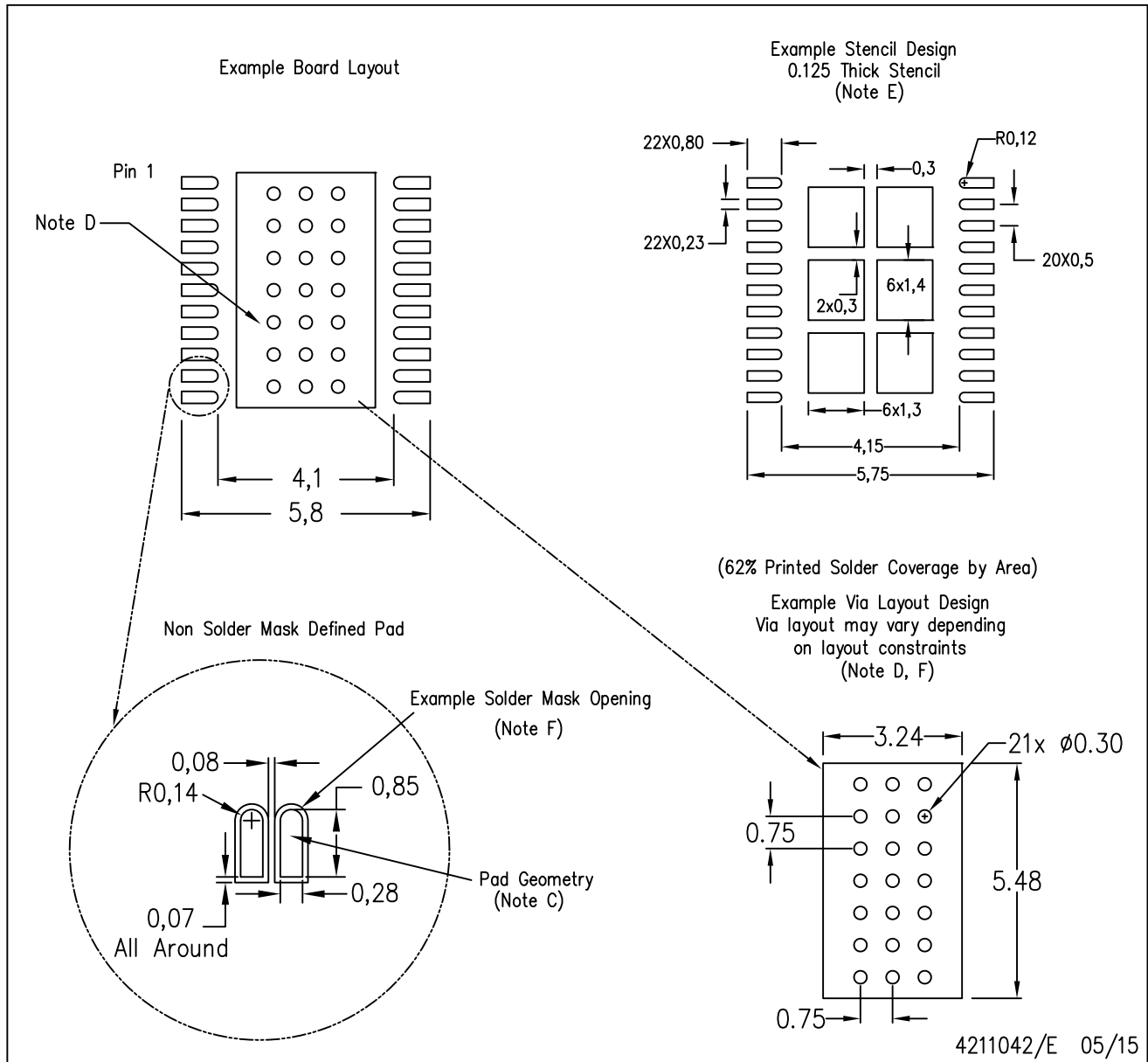

- NOTES:
- All linear dimensions are in millimeters.
  - This drawing is subject to change without notice.
  - Publication IPC-7351 is recommended for alternate designs.
  - This package is designed to be soldered to a thermal pad on the board. Refer to Application Note, QFN/SON PCB Attachment, Texas Instruments Literature No. SLUA271, and also the Product Data Sheets for specific thermal information, via requirements, and recommended board layout. These documents are available at [www.ti.com](http://www.ti.com) <<http://www.ti.com>>.
  - Laser cutting apertures with trapezoidal walls and also rounding corners will offer better paste release. Customers should contact their board assembly site for stencil design recommendations. Refer to IPC 7525 for stencil design considerations.
  - Customers should contact their board fabrication site for recommended solder mask tolerances and via tenting recommendations for vias placed in the thermal pad.

## IMPORTANT NOTICE AND DISCLAIMER

TI PROVIDES TECHNICAL AND RELIABILITY DATA (INCLUDING DATA SHEETS), DESIGN RESOURCES (INCLUDING REFERENCE DESIGNS), APPLICATION OR OTHER DESIGN ADVICE, WEB TOOLS, SAFETY INFORMATION, AND OTHER RESOURCES "AS IS" AND WITH ALL FAULTS, AND DISCLAIMS ALL WARRANTIES, EXPRESS AND IMPLIED, INCLUDING WITHOUT LIMITATION ANY IMPLIED WARRANTIES OF MERCHANTABILITY, FITNESS FOR A PARTICULAR PURPOSE OR NON-INFRINGEMENT OF THIRD PARTY INTELLECTUAL PROPERTY RIGHTS.

These resources are intended for skilled developers designing with TI products. You are solely responsible for (1) selecting the appropriate TI products for your application, (2) designing, validating and testing your application, and (3) ensuring your application meets applicable standards, and any other safety, security, regulatory or other requirements.

These resources are subject to change without notice. TI grants you permission to use these resources only for development of an application that uses the TI products described in the resource. Other reproduction and display of these resources is prohibited. No license is granted to any other TI intellectual property right or to any third party intellectual property right. TI disclaims responsibility for, and you will fully indemnify TI and its representatives against, any claims, damages, costs, losses, and liabilities arising out of your use of these resources.

TI's products are provided subject to [TI's Terms of Sale](#) or other applicable terms available either on [ti.com](https://www.ti.com) or provided in conjunction with such TI products. TI's provision of these resources does not expand or otherwise alter TI's applicable warranties or warranty disclaimers for TI products.

TI objects to and rejects any additional or different terms you may have proposed.

Mailing Address: Texas Instruments, Post Office Box 655303, Dallas, Texas 75265  
Copyright © 2023, Texas Instruments Incorporated

## Looking for pricing, stock, or lifecycle information?

Click below to explore more details on WIN SOURCE:

 [View TPS56121DQPR](#) on WIN SOURCE

 [Texas Instruments](#) Information

## Optimize Your Supply Chain with WIN SOURCE Solutions

-  Global Sourcing Solution
-  Obsolete Management
-  Cost Control Management
-  Shortage Management
-  Alternative Solution
-  Excess Inventory Management