



**THE DATASHEET OF
TPS61253YFFR**



TPS6125x 3.5-MHz High Efficiency Step-Up Converter In Chip Scale Packaging

1 Features

- 93% Efficiency at 3.5-MHz Operation
- 21- μ A Quiescent Current in Standby Mode
- 37- μ A Quiescent Current in Normal Operation
- Wide V_{IN} Range From 2.3 V to 5.5 V
- $V_{IN} \geq V_{OUT}$ Operation
- $I_{OUT} \geq 800$ mA at $V_{OUT} = 4.5$ V, $V_{IN} \geq 2.65$ V
- $I_{OUT} \geq 1000$ mA at $V_{OUT} = 5.0$ V, $V_{IN} \geq 3.3$ V
- $I_{OUT} \geq 1500$ mA (Peak) at $V_{OUT} = 5.0$ V, $V_{IN} \geq 3.3$ V
- $\pm 2\%$ Total DC Voltage Accuracy
- Light-Load PFM Mode
- Selectable Standby Mode or True Load Disconnect During Shutdown
- Thermal Shutdown and Overload Protection
- Only Three Surface-Mount External Components Required
- Total Solution Size < 25 mm²
- 9-Pin NanoFree™ (CSP) Packaging

2 Applications

- Cell Phones, Smart Phones
- Mono and Stereo APA Applications
- USB Charging Ports (5V)

3 Description

The TPS6125x device provides a power supply solution for battery-powered portable applications. Intended for low-power applications, the TPS6125x supports up to 800-mA load current from a battery discharged as low as 2.65V and allows the use of low cost chip inductor and capacitors.

With a wide input voltage range of 2.3 V to 5.5 V, the device supports applications powered by Li-Ion batteries with extended voltage range. Different fixed voltage output versions are available from 3.15 V to 5.0 V.

The TPS6125x operates at a regulated 3.5-MHz switching frequency and enters power-save mode operation at light load currents to maintain high efficiency over the entire load current range. The PFM mode extends the battery life by reducing the quiescent current to 37 μ A (typ) during light load operation.

In addition, the TPS6125x device can also maintain its output biased at the input voltage level. In this mode, the synchronous rectifier is current limited allowing external load (e.g. audio amplifier) to be powered with a restricted supply. In this mode, the quiescent current is reduced to 21 μ A. During shutdown, the load is completely disconnected from the battery. Input current in shutdown mode is less than 1 μ A (typ), which maximizes battery life.

The TPS6125x offers a very small solution size due to minimum amount of external components. It allows the use of small inductors and input capacitors to achieve a small solution size.

Device Information⁽¹⁾

PART NUMBER	PACKAGE	BODY SIZE (NOM)
TPS6125x	DSBGA (9)	1.206 mm x 1.306 mm

(1) For all available packages, see the orderable addendum at the end of the datasheet.

Efficiency vs Load Current

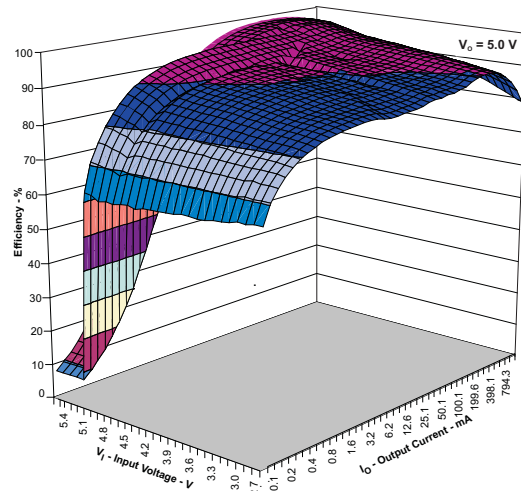

Table of Contents

1 Features	1	10 Application and Implementation	19
2 Applications	1	10.1 Application Information.....	19
3 Description	1	10.2 Typical Application	19
4 Revision History	2	10.3 System Examples	24
5 Device Options	4	11 Power Supply Recommendations	26
6 Pin Configuration and Functions	4	12 Layout	26
7 Specifications	5	12.1 Layout Guidelines	26
7.1 Absolute Maximum Ratings	5	12.2 Layout Example	26
7.2 ESD Ratings.....	5	12.3 Thermal Considerations	27
7.3 Recommended Operating Conditions.....	5	13 Device and Documentation Support	28
7.4 Thermal Information	6	13.1 Device Support.....	28
7.5 Electrical Characteristics.....	6	13.2 Related Links	28
7.6 Typical Characteristics	9	13.3 Receiving Notification of Documentation Updates	28
8 Parameter Measurement Information	14	13.4 Community Resources.....	28
9 Detailed Description	15	13.5 Trademarks	28
9.1 Overview	15	13.6 Electrostatic Discharge Caution.....	28
9.2 Functional Block Diagram	15	13.7 Glossary	28
9.3 Feature Description.....	16	14 Mechanical, Packaging, and Orderable	Information
9.4 Device Functional Modes.....	17	14.1 Package Summary.....	29

4 Revision History

NOTE: Page numbers for previous revisions may differ from page numbers in the current version.

Changes from Revision F (March 2016) to Revision G	Page
• Changed the <i>Package Dimensions</i> section.....	29
<hr/>	
Changes from Revision E (March 2015) to Revision F	Page
• Added device TPS612592.....	4
<hr/>	
Changes from Revision D (December 2014) to Revision E	Page
• Changed Body Size (NOM) from "1.60 mm × 1.60" to "1.206 mm × 1.306" in the Device Information table.....	1
• Added table note reference to Third-Party Products Disclaimer	19
<hr/>	
Changes from Revision C (August 2012) to Revision D	Page
• Added <i>ESD Ratings</i> table, <i>Feature Description</i> section, <i>Device Functional Modes</i> , <i>Application and Implementation</i> section, <i>Power Supply Recommendations</i> section, <i>Layout</i> section, <i>Device and Documentation Support</i> section, and <i>Mechanical, Packaging, and Orderable Information</i> section	1
<hr/>	
Changes from Revision B (May 2012) to Revision C	Page
• Added TPS61259 to data sheet header as production device.....	1
• Changed device TPS61259 to production status	4

Changes from Revision A (October 2011) to Revision B	Page
• Added TPS61253 and TPS61258 to data sheet header as production devices.....	1
• Changed devices TPS61253 and TPS61258 to production status.....	4
• Changed graphic entity for Figure 3	10
• Changed graphic entity for Figure 10 and Figure 13	11
• Changed graphic entity for Figure 23	13

5 Device Options

T _A	PART NUMBER ⁽¹⁾	OUTPUT VOLTAGE	DEVICE SPECIFIC FEATURES
–40°C to 85°C	TPS61253	5.0 V	Supports 5 V, up to 1500 mA peak loading down to 3.3 V input voltage
	TPS61254	4.5 V	Supports 4.5 V / 800 mA loading down to 2.65 V input voltage
	TPS61255 ⁽²⁾	3.75 V	
	TPS61256	5.0 V	Supports 5 V / 900 mA loading down to 3.3 V input voltage
	TPS61257 ⁽²⁾	4.3 V	
	TPS61258	4.5 V	Supports 4.5 V, up to 1500 mA peak loading down to 3.3 V input voltage
	TPS61259	5.1 V	Supports 5.1 V, up to 1500 mA peak loading down to 3.3 V input voltage
	TPS612592	5.2 V	Supports 5.2 V, up to 1500 mA peak loading down to 3.3 V input voltage

(1) For all available packages, see the orderable addendum at the end of the datasheet.

(2) Product preview. [Contact TI factory for more information](#)

6 Pin Configuration and Functions

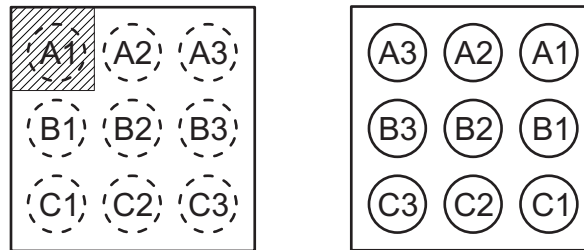

Pin Functions

PIN		I/O	DESCRIPTION
NAME	NO.		
BP	C3	I	This is the mode selection pin of the device and is only of relevance when the device is disabled (EN = Low). This pin must not be left floating and must be terminated. Refer to Table 2 for more details. BP = Low: The device is in true shutdown mode. BP = High: The output is biased at the input voltage level with a maximum load current capability of ca. 150mA. In standby mode, the device only consumes a standby current of 21µA (typ).
EN	B3	I	This is the enable pin of the device. Connecting this pin to ground forces the device into shutdown mode. Pulling this pin high enables the device. This pin must not be left floating and must be terminated.
GND	C1, C2		Ground pin.
SW	B1, B2	I/O	This is the switch pin of the converter and is connected to the drain of the internal Power MOSFETs.
VIN	A3	I	Power supply input.
VOUT	A1, A2	O	Boost converter output.

7 Specifications

7.1 Absolute Maximum Ratings

over operating free-air temperature range (unless otherwise noted)⁽¹⁾

		MIN	MAX	UNIT
Input voltage	Voltage at VIN ⁽²⁾ , VOUT ⁽²⁾ , SW ⁽²⁾ , EN ⁽²⁾ , BP ⁽²⁾	-0.3	7	V
Input current	Continuous average current into SW ⁽³⁾	1.8		A
	Peak current into SW ⁽⁴⁾	3.5		
Power dissipation		Internally limited		
Temperature	Operating, T _A ⁽⁵⁾	-40	85	°C
	Operating virtual junction, T _J	-40	150	
	Storage, T _{stg}	-65	150	

- (1) Stresses beyond those listed under *absolute maximum ratings* may cause permanent damage to the device. These are stress ratings only, and functional operation of the device at these or any other conditions beyond those indicated under *recommended operating conditions* is not implied. Exposure to absolute-maximum-rated conditions for extended periods may affect device reliability.
- (2) All voltages are with respect to network ground terminal.
- (3) Limit the junction temperature to 105°C for continuous operation at maximum output power.
- (4) Limit the junction temperature to 125°C for 5% duty cycle operation.
- (5) In applications where high power dissipation and/or poor package thermal resistance is present, the maximum ambient temperature may have to be derated. Maximum ambient temperature (T_{A(max)}) is dependent on the maximum operating junction temperature (T_{J(max)}), the maximum power dissipation of the device in the application (P_{D(max)}), and the junction-to-ambient thermal resistance of the part/package in the application (θ_{JA}), as given by the following equation: T_{A(max)} = T_{J(max)} - (θ_{JA} × P_{D(max)}). To achieve optimum performance, it is recommended to operate the device with a maximum junction temperature of 105°C.

7.2 ESD Ratings

		VALUE	UNIT
V _(ESD) Electrostatic discharge	Human-body model (HBM), per ANSI/ESDA/JEDEC JS-001 ⁽¹⁾	±2000	V
	Charged-device model (CDM), per JEDEC specification JESD22-C101 ⁽²⁾	±1000	
	Machine model (MM)	±200	

- (1) JEDEC document JEP155 states that 500-V HBM allows safe manufacturing with a standard ESD control process. Manufacturing with less than 500-V HBM is possible with the necessary precautions.
- (2) JEDEC document JEP157 states that 250-V CDM allows safe manufacturing with a standard ESD control process. Manufacturing with less than 250-V CDM is possible with the necessary precautions.

7.3 Recommended Operating Conditions

		MIN	NOM	MAX	UNIT
V _I Input voltage range	TPS61253	2.65 ⁽¹⁾		4.85	V
	TPS61254	2.5		4.35	
	TPS61256	2.5		4.85	
	TPS61257	2.5		4.15	
	TPS61258	2.65 ⁽¹⁾		4.35	
	TPS61259	2.65 ⁽¹⁾		4.85	
	TPS612592	2.65 ⁽¹⁾		4.85	
R _L Minimum resistive load for start-up	TPS6125x	55			Ω
L Inductance		0.7	1.0	2.9	μH
C _O Output capacitance		3.5	5	50	μF
T _A Ambient temperature		-40		85	°C
T _J Operating junction temperature		-40		125	°C

- (1) Up to 1000mA peak output current.

7.4 Thermal Information

THERMAL METRIC ⁽¹⁾		TPS6125x		UNIT
		YFF		
		9 PINS		
R _{θJA}	Junction-to-ambient thermal resistance	108.3		°C/W
R _{θJC(top)}	Junction-to-case (top) thermal resistance	1.0		
R _{θJB}	Junction-to-board thermal resistance	18		
ψ _{JT}	Junction-to-top characterization parameter	4.2		
ψ _{JB}	Junction-to-board characterization parameter	17.9		

(1) For more information about traditional and new thermal metrics, see the [Semiconductor and IC Package Thermal Metrics](#) application report.

7.5 Electrical Characteristics

Minimum and maximum values are at V_{IN} = 2.3V to 5.5V, EN = 1.8V, T_A = –40°C to 85°C; Circuit of Parameter Measurement Information section (unless otherwise noted). Typical values are at V_{IN} = 3.6V, EN = 1.8V, T_A = 25°C (unless otherwise noted).

PARAMETER		TEST CONDITIONS	MIN	TYP	MAX	UNIT
SUPPLY CURRENT						
I _Q	Operating quiescent current into V _{IN} Operating quiescent current into V _{OUT} Standby mode quiescent current into V _{IN} Standby mode quiescent current into V _{OUT}	I _{OUT} = 0mA, V _{IN} = 3.6V EN = V _{IN} , BP = GND Device not switching	30	45		μA
			7	15		μA
		I _{OUT} = 0mA, V _{IN} = V _{OUT} = 3.6V EN = GND, BP = V _{IN} Device not switching	11	20		μA
			9.5	15		μA
I _{SD}	Shutdown current	EN = GND, BP = GND	0.85	5.0		μA
V _{UVLO}	Under-voltage lockout threshold	Falling	2.0	2.1		V
		Hysteresis	0.1			V
ENABLE, BYPASS						
V _{IL}	Low-level input voltage				0.4	V
V _{IH}	High-level input voltage		1.0			V
I _{lkg}	Input leakage current	Input connected to GND or V _{IN}			0.5	μA

Electrical Characteristics (continued)

Minimum and maximum values are at $V_{IN} = 2.3V$ to $5.5V$, $EN = 1.8V$, $T_A = -40^{\circ}C$ to $85^{\circ}C$; Circuit of Parameter Measurement Information section (unless otherwise noted). Typical values are at $V_{IN} = 3.6V$, $EN = 1.8V$, $T_A = 25^{\circ}C$ (unless otherwise noted).

PARAMETER		TEST CONDITIONS		MIN	TYP	MAX	UNIT
OUTPUT							
V_{OUT}	Regulated DC output voltage	TPS61253	$2.3V \leq V_{IN} \leq 4.85V$, $I_{OUT} = 0mA$ PWM operation. Open Loop	4.92	5	5.08	V
			$3.3V \leq V_{IN} \leq 4.85V$, $0mA \leq I_{OUT} \leq 1000mA$ PFM/PWM operation	4.85	5	5.2	
			$3.3V \leq V_{IN} \leq 4.85V$, $0mA \leq I_{OUT} \leq 1500mA$ PFM/PWM operation Pulsed load test; Pulse width $\leq 20ms$; Duty cycle $\leq 10\%$	4.75	5	5.2	
	Regulated DC output voltage	TPS61254	$2.3V \leq V_{IN} \leq 4.35V$, $I_{OUT} = 0mA$ PWM operation. Open Loop	4.43	4.5	4.57	V
			$2.65V \leq V_{IN} \leq 4.35V$, $0mA \leq I_{OUT} \leq 800mA$ PFM/PWM operation	4.4	4.5	4.65	
	Regulated DC output voltage	TPS61256	$2.3V \leq V_{IN} \leq 4.85V$, $I_{OUT} = 0mA$ PWM operation. Open Loop	4.92	5	5.08	V
			$2.65V \leq V_{IN} \leq 4.85V$, $0mA \leq I_{OUT} \leq 700mA$ PFM/PWM operation	4.9	5	5.2	
	Regulated DC output voltage	TPS61257	$2.3V \leq V_{IN} \leq 4.15V$, $I_{OUT} = 0mA$ PWM operation. Open loop.	4.23	4.3	4.37	V
			$2.65V \leq V_{IN} \leq 4.15V$, $0mA \leq I_{OUT} \leq 800mA$ PFM/PWM operation	4.2	4.3	4.45	
	Regulated DC output voltage	TPS61258	$2.3V \leq V_{IN} \leq 4.35V$, $I_{OUT} = 0mA$ PWM operation. Open Loop	4.43	4.5	4.57	V
$3.3V \leq V_{IN} \leq 4.35V$, $0mA \leq I_{OUT} \leq 1500mA$ PFM/PWM operation Pulsed load test; Pulse width $\leq 20ms$; Duty cycle $\leq 10\%$			4.3	4.5	4.65		
Regulated DC output voltage	TPS61259	$2.3V \leq V_{IN} \leq 4.85V$, $I_{OUT} = 0mA$ PWM operation. Open Loop	5.02	5.1	5.18	V	
		$3.4V \leq V_{IN} \leq 4.85V$, $0mA \leq I_{OUT} \leq 1500mA$ PFM/PWM operation Pulsed load test; Pulse width $\leq 20ms$; Duty cycle $\leq 10\%$	4.75	5.1	5.3		
Regulated DC output voltage	TPS612592	$2.7V \leq V_{IN} \leq 4.8V$, $I_{OUT} = 0mA$ PWM operation. Open Loop	5.1	5.2	5.3	V	
ΔV_{OUT}	Power-save mode output ripple voltage	TPS61254 TPS61258	PFM operation, $I_{OUT} = 1mA$	45		mVpk	
	Standby mode output ripple voltage		$EN = GND$, $BP = V_{IN}$, $I_{OUT} = 0mA$	80			
	PWM mode output ripple voltage		PWM operation, $I_{OUT} = 200mA$	20			
	Power-save mode output ripple voltage	TPS61253 TPS61256	PFM operation, $I_{OUT} = 1mA$	50		mVpk	
	Standby mode output ripple voltage	TPS61259 TPS612592	$EN = GND$, $BP = V_{IN}$, $I_{OUT} = 0mA$	80			

Electrical Characteristics (continued)

Minimum and maximum values are at $V_{IN} = 2.3V$ to $5.5V$, $EN = 1.8V$, $T_A = -40^{\circ}C$ to $85^{\circ}C$; Circuit of Parameter Measurement Information section (unless otherwise noted). Typical values are at $V_{IN} = 3.6V$, $EN = 1.8V$, $T_A = 25^{\circ}C$ (unless otherwise noted).

PARAMETER		TEST CONDITIONS	MIN	TYP	MAX	UNIT		
POWER SWITCH								
$r_{DS(on)}$	High-side MOSFET on resistance			170		m Ω		
	Low-side MOSFET on resistance			100				
I_{lkg}	Reverse leakage current into VOUT	EN = GND, BP = GND			3.5	μA		
I_{LIM}	Switch valley current limit	TPS61253 TPS61258 TPS61259 TPS612592	EN = V_{IN} , BP = GND. Open Loop		3300	3620	3900	mA
		TPS61254 TPS61256 TPS61257	EN = V_{IN} , BP = GND. Open Loop		1900	2150	2400	
	Pre-charge mode current limit (linear mode)	EN = GND, BP = V_{IN}		165	215	265	mA	
Overtemperature protection				140		$^{\circ}C$		
Overtemperature hysteresis				20		$^{\circ}C$		
OSCILLATOR								
f_{OSC}	Oscillator frequency	$V_{IN} = 3.6V$ $V_{OUT} = 4.5V$		3.5		MHz		
TIMING								
Start-up time	TPS6125x	BP = GND, $I_{OUT} = 0mA$. Time from active EN to start switching		70		μs		
	TPS61253 TPS61254 TPS61256 TPS61258 TPS61259 TPS612592	BP = GND, $I_{OUT} = 0mA$. Time from active EN to V_{OUT}		400		μs		

7.6 Typical Characteristics

Table 1. Table of Graphs

			FIGURE
η	Efficiency	vs Output current	Figure 1, Figure 2, Figure 3, Figure 5
		vs Input voltage	Figure 4
V_O	DC output voltage	vs Output current	Figure 6, Figure 7, Figure 8, Figure 9, Figure 10, Figure 14
		vs Input voltage	Figure 11
I_O	Maximum output current	vs Input voltage	Figure 12, Figure 13
ΔV_O	Peak-to-peak output ripple voltage	vs Output current	Figure 15, Figure 16, Figure 17
I_{CC}	Supply current	vs Input voltage	Figure 18, Figure 19
I_{LIM}	DC pre-charge current	vs Differential input-output voltage	Figure 20, Figure 21
	Valley current limit	vs Temperature	Figure 22, Figure 23
$r_{DS(on)}$	MOSFET $r_{DS(on)}$	vs Temperature	Figure 24

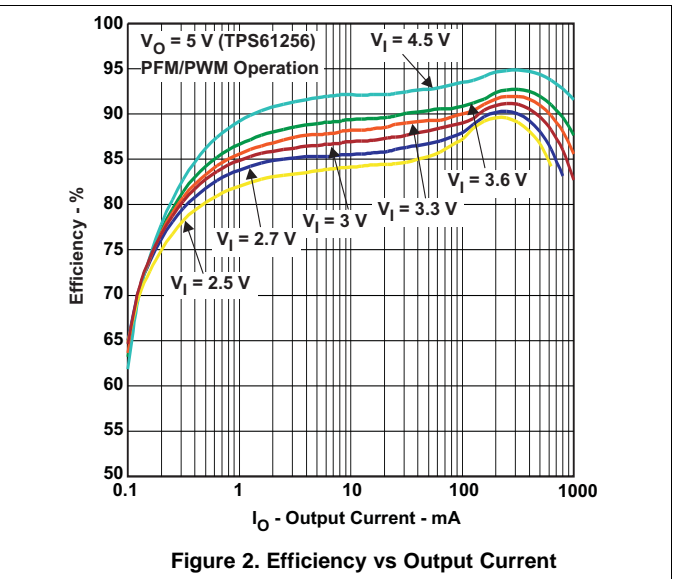
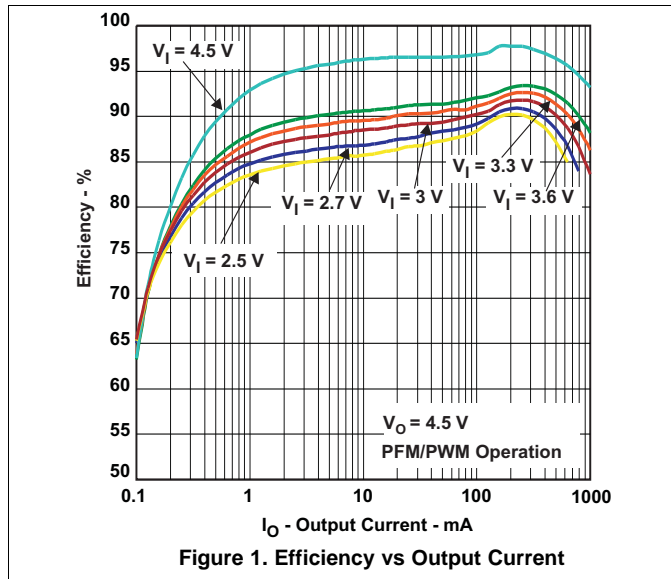

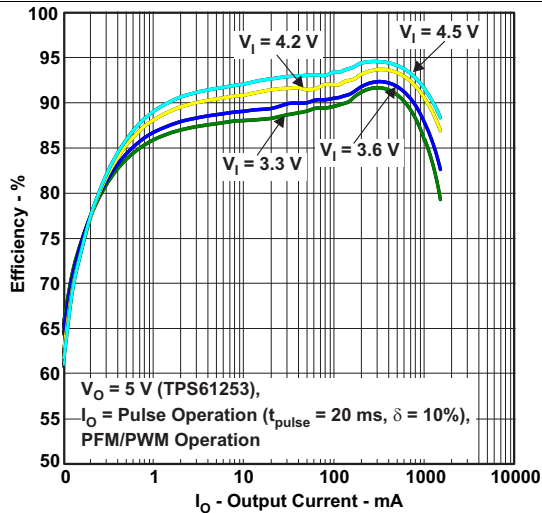

Figure 3. Efficiency vs Output Current

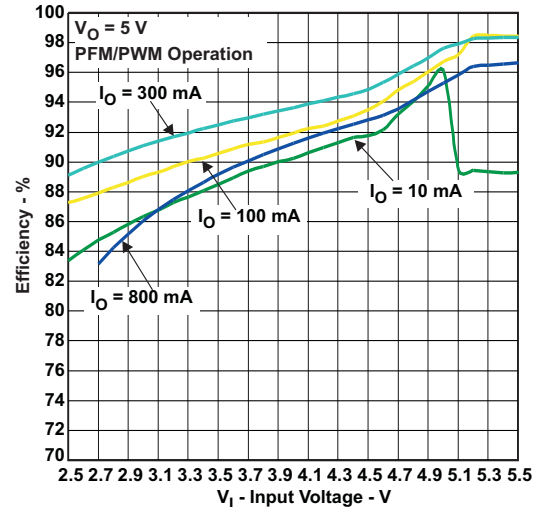

Figure 4. Efficiency vs Input Voltage

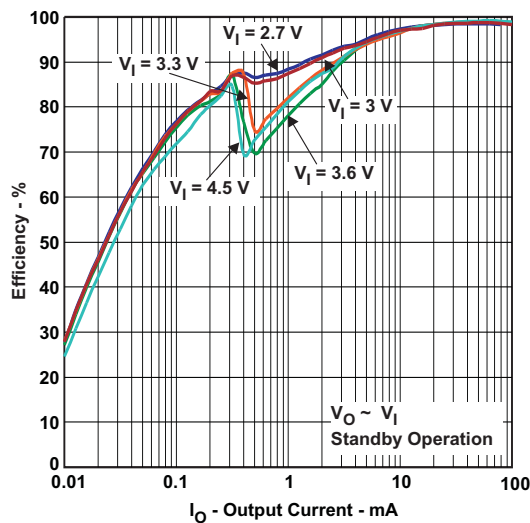

Figure 5. Efficiency vs Output Current

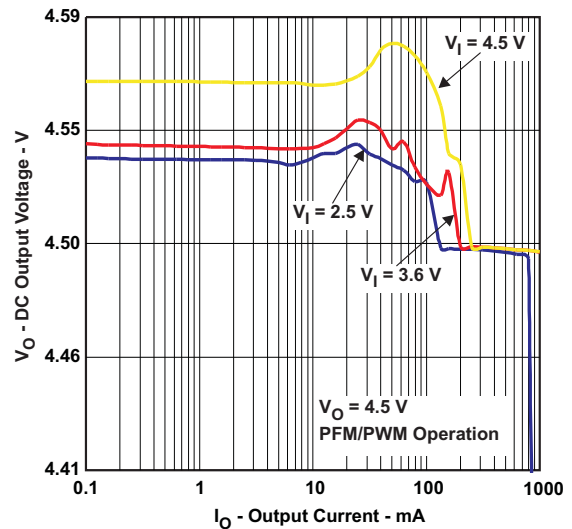

Figure 6. DC Output Voltage vs Output Current

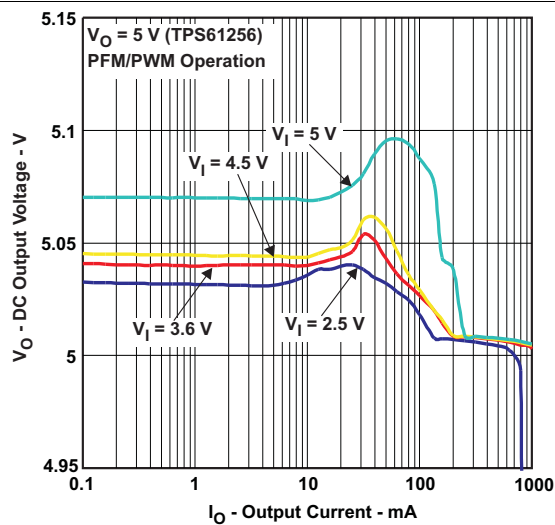

Figure 7. DC Output Voltage vs Output Current

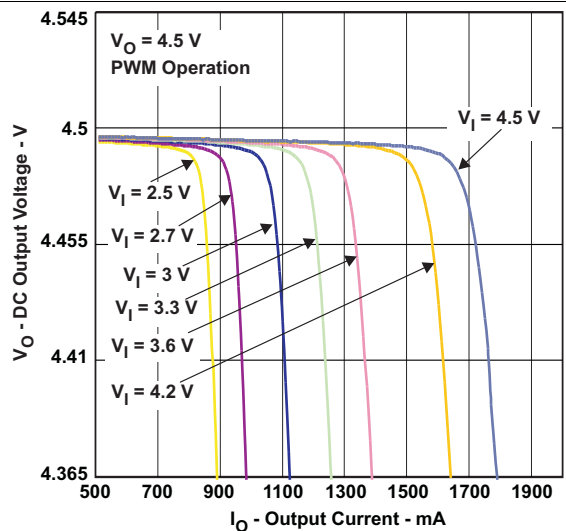

Figure 8. DC Output Voltage vs Output Current

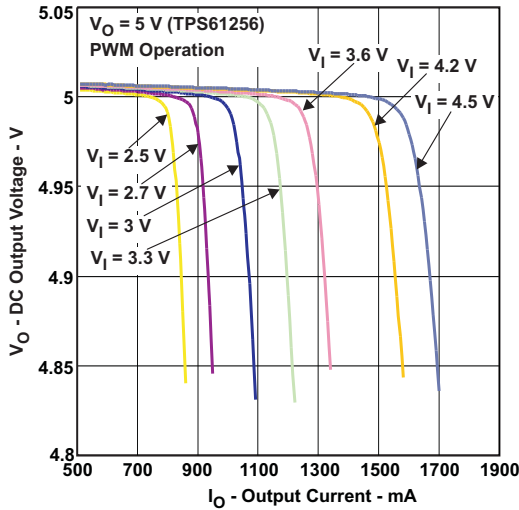

Figure 9. DC Output Voltage vs Output Current

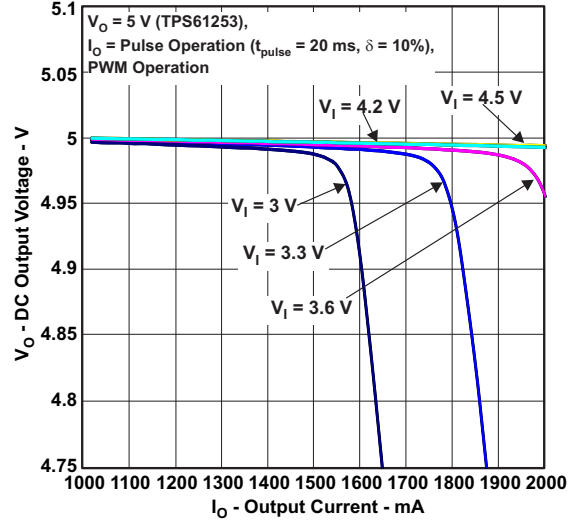

Figure 10. DC Output Voltage vs Output Current

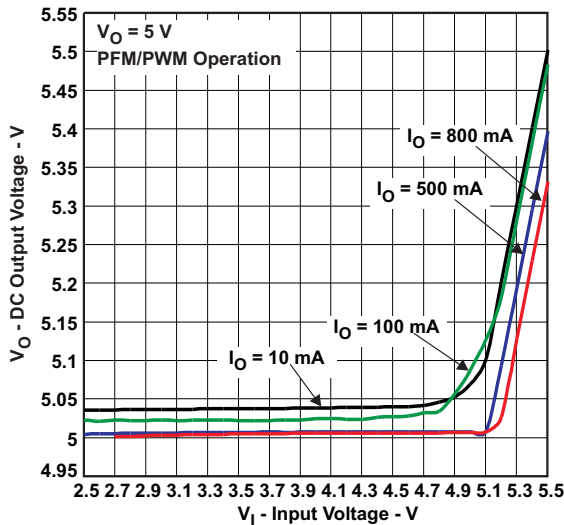

Figure 11. DC Output Voltage vs Input Voltage

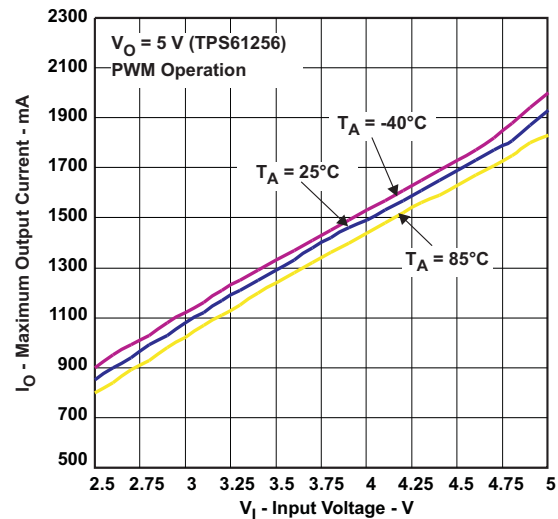

Figure 12. Maximum Output Current vs Input Voltage

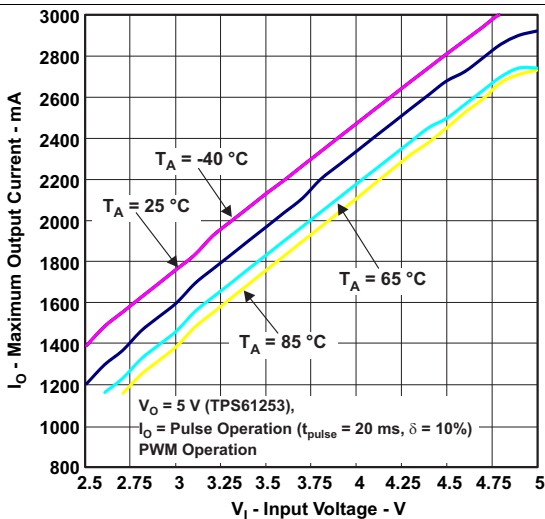

Figure 13. Maximum Output Current vs Input Voltage

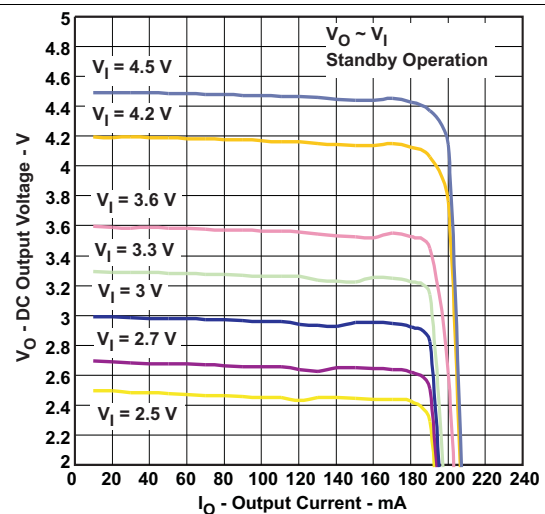

Figure 14. DC Output Voltage vs Output Current

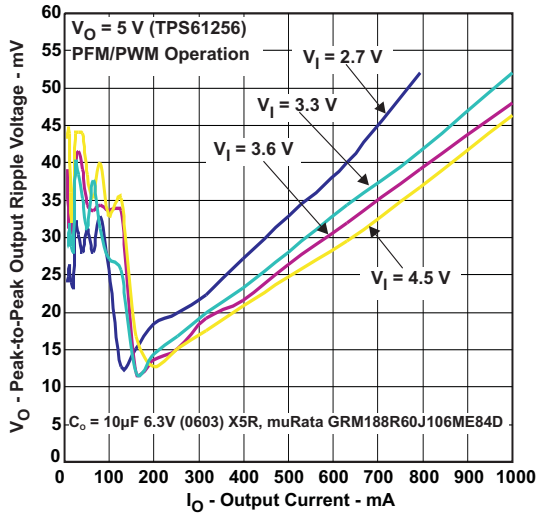

Figure 15. Peak-to-Peak Output Ripple Voltage vs Output Current

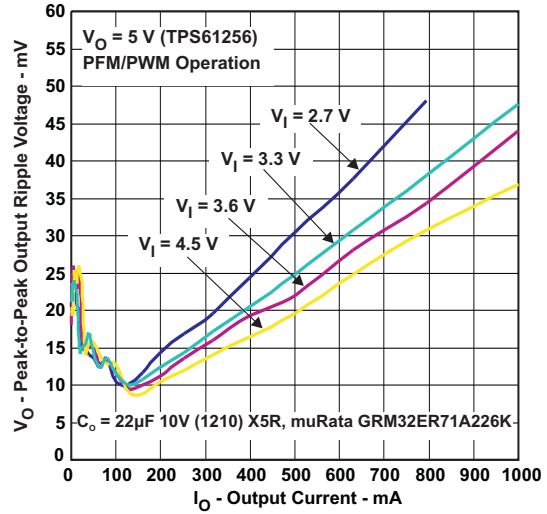

Figure 16. Peak-to-Peak Output Ripple Voltage vs Output Current

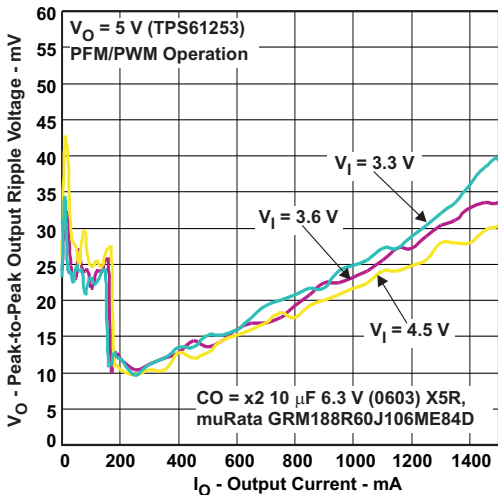

Figure 17. Peak-to-Peak Output Ripple Voltage vs Output Current

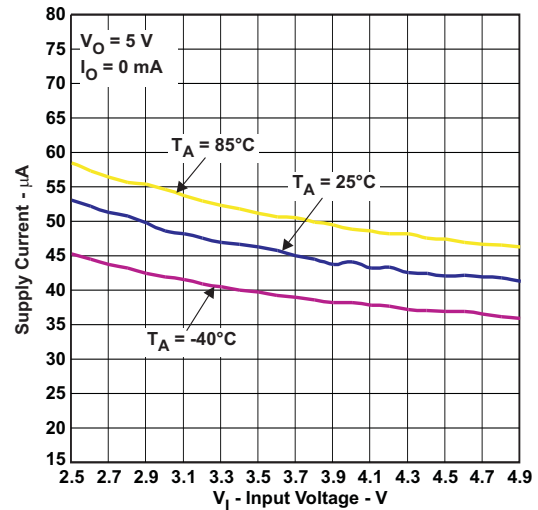

Figure 18. Supply Current vs Input Voltage

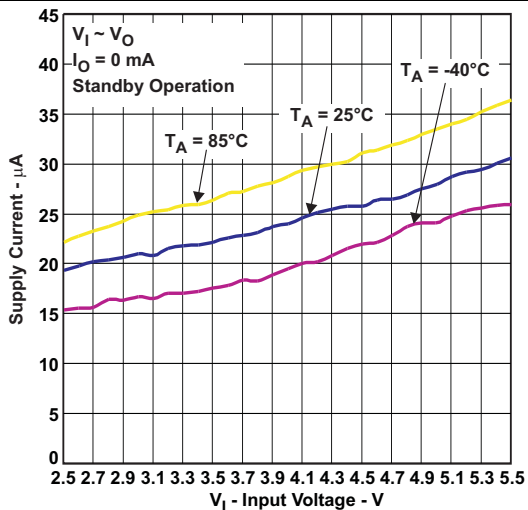

Figure 19. Supply Current vs Input Voltage

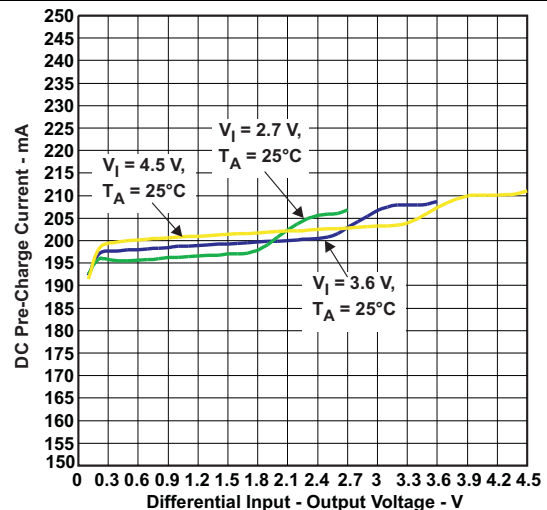

Figure 20. DC Pre-Charge Current vs Differential Input-Output Voltage

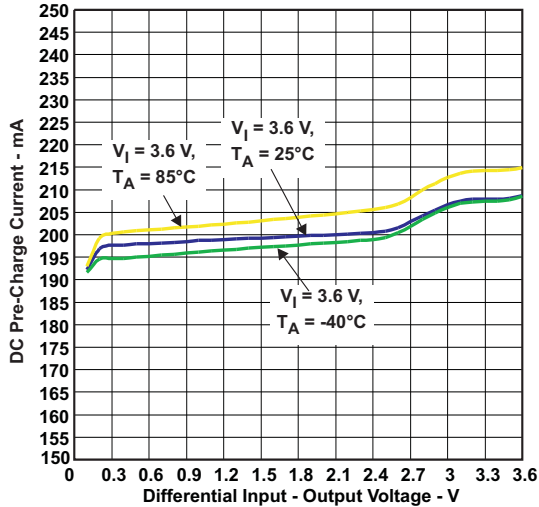

Figure 21. DC Pre-Charge Current vs Differential Input-Output Voltage

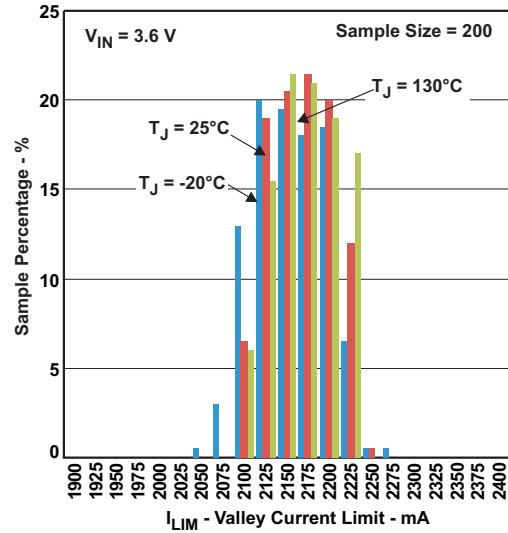

Figure 22. Valley Current Limit

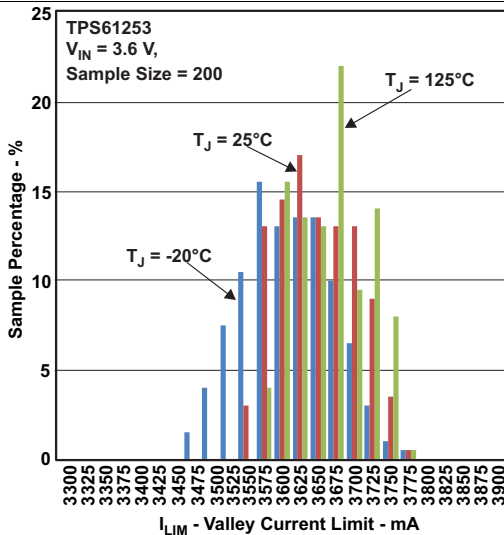

Figure 23. Valley Current Limit

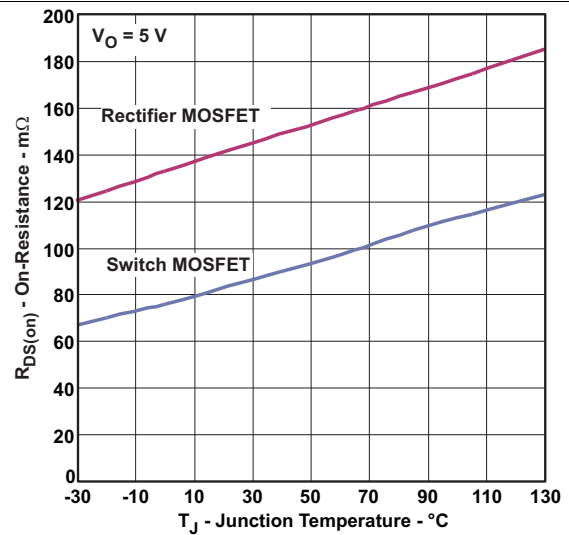
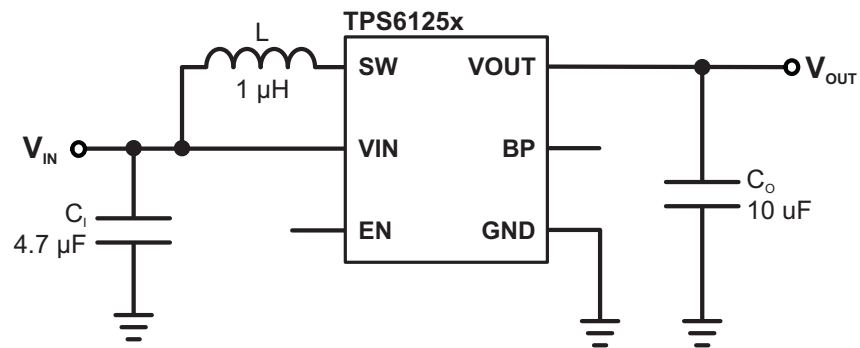

Figure 24. MOSFET $r_{DS(on)}$ vs Temperature

8 Parameter Measurement Information



	EN	BP
Shutdown, True Load Disconnect (SD)	0	0
Standby Mode, Output Pre-Biased (SM)	0	1
Boost Operating Mode (BST)	1	X

Figure 25. Parameter Measurement Schematic

9 Detailed Description

9.1 Overview

The TPS6125x synchronous step-up converter typically operates at a quasi-constant 3.5-MHz frequency pulse width modulation (PWM) at moderate to heavy load currents. At light load currents, the TPS6125x converter operates in power-save mode with pulse frequency modulation (PFM).

During PWM operation, the converter uses a novel quasi-constant on-time valley current mode control scheme to achieve excellent line/load regulation and allows the use of a small ceramic inductor and capacitors. Based on the V_{IN}/V_{OUT} ratio, a simple circuit predicts the required on-time.

At the beginning of the switching cycle, the low-side N-MOS switch is turned-on and the inductor current ramps up to a peak current that is defined by the on-time and the inductance. In the second phase, once the on-timer has expired, the rectifier is turned-on and the inductor current decays to a preset valley current threshold. Finally, the switching cycle repeats by setting the on timer again and activating the low-side N-MOS switch.

In general, a dc/dc step-up converter can only operate in "true" boost mode, i.e. the output "boosted" by a certain amount above the input voltage. The TPS6125x device operates differently as it can smoothly transition in and out of zero duty cycle operation. Therefore the output can be kept as close as possible to its regulation limits even though the converter is subject to an input voltage that tends to be excessive. In this operation mode, the output current capability of the regulator is limited to ca. 150mA. Refer to [Figure 11](#) for further details.

The current mode architecture with adaptive slope compensation provides excellent transient load response, requiring minimal output filtering. Internal soft-start and loop compensation simplifies the design process while minimizing the number of external components.

9.2 Functional Block Diagram

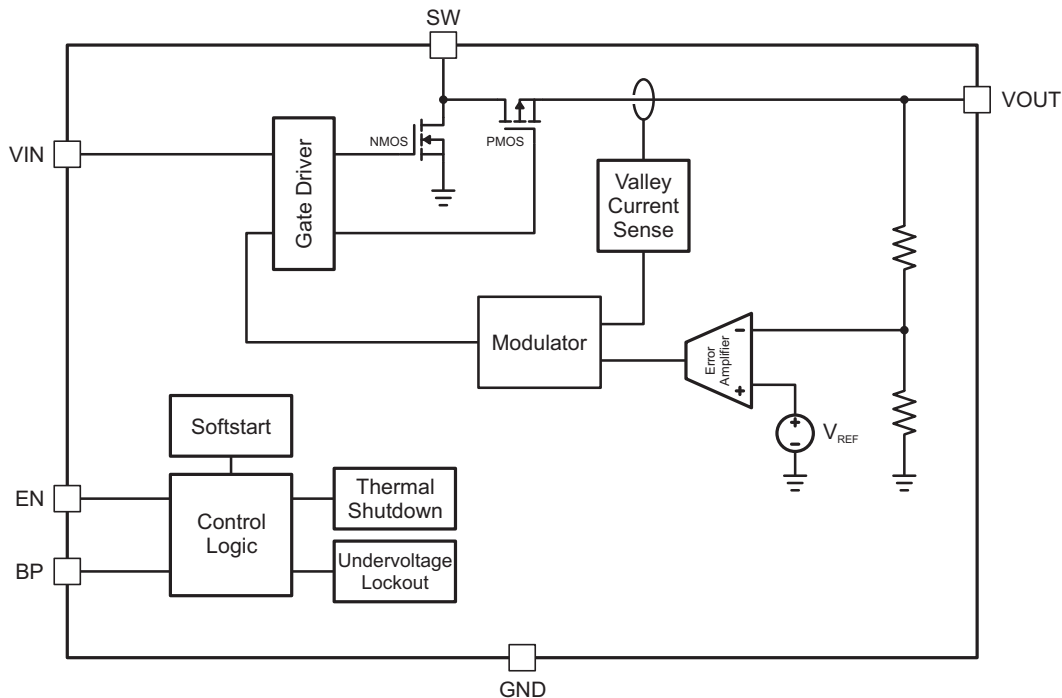

Copyright © 2016, Texas Instruments Incorporated

9.3 Feature Description

9.3.1 Current Limit Operation

The TPS6125x device employs a valley current limit sensing scheme. Current limit detection occurs during the off-time by sensing of the voltage drop across the synchronous rectifier.

The output voltage is reduced as the power stage of the device operates in a constant current mode. The maximum continuous output current ($I_{OUT(CL)}$), before entering current limit (CL) operation, can be defined by Equation 1.

$$I_{OUT(CL)} = (1 - D) \cdot (I_{VALLEY} + \frac{1}{2} \Delta I_L) \quad (1)$$

The duty cycle (D) can be estimated by Equation 2

$$D = 1 - \frac{V_{IN} \cdot \eta}{V_{OUT}} \quad (2)$$

and the peak-to-peak current ripple (ΔI_L) is calculated by Equation 3

$$\Delta I_L = \frac{V_{IN}}{L} \cdot \frac{D}{f} \quad (3)$$

The output current, $I_{OUT(DC)}$, is the average of the rectifier ripple current waveform. When the load current is increased such that the lower peak is above the current limit threshold, the off-time is increased to allow the current to decrease to this threshold before the next on-time begins (so called frequency fold-back mechanism). When the current limit is reached the output voltage decreases during further load increase.

Figure 26 illustrates the inductor and rectifier current waveforms during current limit operation.

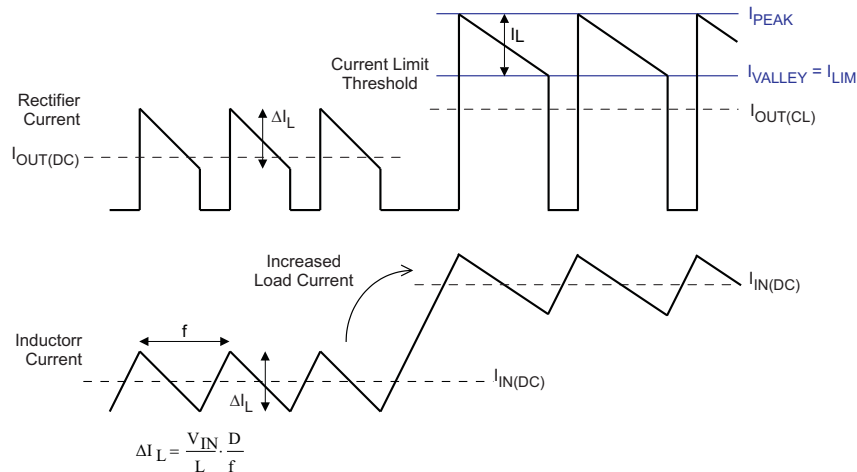

Figure 26. Inductor/Rectifier Currents in Current Limit Operation

9.3.2 Enable

The TPS6125x device starts operation when EN is set high and starts up with the soft-start sequence. For proper operation, the EN pin must be terminated and must not be left floating.

Pulling the EN and BP pins low forces the device in shutdown, with a shutdown current of typically 1 μ A. In this mode, true load disconnect between the battery and load prevents current flow from V_{IN} to V_{OUT} , as well as reverse flow from V_{OUT} to V_{IN} .

Pulling the EN pin low and the BP pin high forces the device in standby mode, refer to the [Standby Mode](#) section for more details.

Feature Description (continued)

9.3.3 Load Disconnect and Reverse Current Protection

Regular boost converters do not disconnect the load from the input supply and therefore a connected battery will be discharged during shutdown. The advantage of TPS6125x is that this converter disconnects the output from the input of the power supply when it is disabled (so called true shutdown mode). In case of a connected battery it prevents it from being discharged during shutdown of the converter.

9.3.4 Softstart

The TPS6125x device has an internal softstart circuit that limits the inrush current during start-up. The first step in the start-up cycle is the pre-charge phase. During pre-charge, the rectifying switch is turned on until the output capacitor is charged to a value close to the input voltage. The rectifying switch is current limited (approximately 200 mA) during this phase. This mechanism is used to limit the output current under short-circuit condition.

Once the output capacitor has been biased to the input voltage, the converter starts switching. The soft-start system progressively increases the on-time as a function of the input-to-output voltage ratio. As soon as the output voltage is reached, the regulation loop takes control and full current operation is permitted.

9.3.5 Undervoltage Lockout

The under voltage lockout circuit prevents the device from malfunctioning at low input voltages and the battery from excessive discharge. It disables the output stage of the converter once the falling V_{IN} trips the under-voltage lockout threshold V_{UVLO} which is typically 2.0V. The device starts operation once the rising V_{IN} trips V_{UVLO} threshold plus its hysteresis of 100 mV at typically 2.1 V.

9.3.6 Thermal Regulation

The TPS6125x device contains a thermal regulation loop that monitors the die temperature during the pre-charge phase. If the die temperature rises to high values of about 110 °C, the device automatically reduces the current to prevent the die temperature from increasing further. Once the die temperature drops about 10 °C below the threshold, the device will automatically increase the current to the target value. This function also reduces the current during a short-circuit condition.

9.3.7 Thermal Shutdown

As soon as the junction temperature, T_J , exceeds 140°C (typ.) the device goes into thermal shutdown. In this mode, the high-side and low-side MOSFETs are turned-off. When the junction temperature falls below the thermal shutdown minus its hysteresis, the device continues the operation.

9.4 Device Functional Modes

9.4.1 Power Save Mode

The TPS6125x integrates a power save mode to improve efficiency at light load. In power save mode the converter only operates when the output voltage trips below a set threshold voltage.

It ramps up the output voltage with several pulses and goes into power save mode once the output voltage exceeds the set threshold voltage.

The PFM mode is left and PWM mode entered in case the output current can not longer be supported in PFM mode.

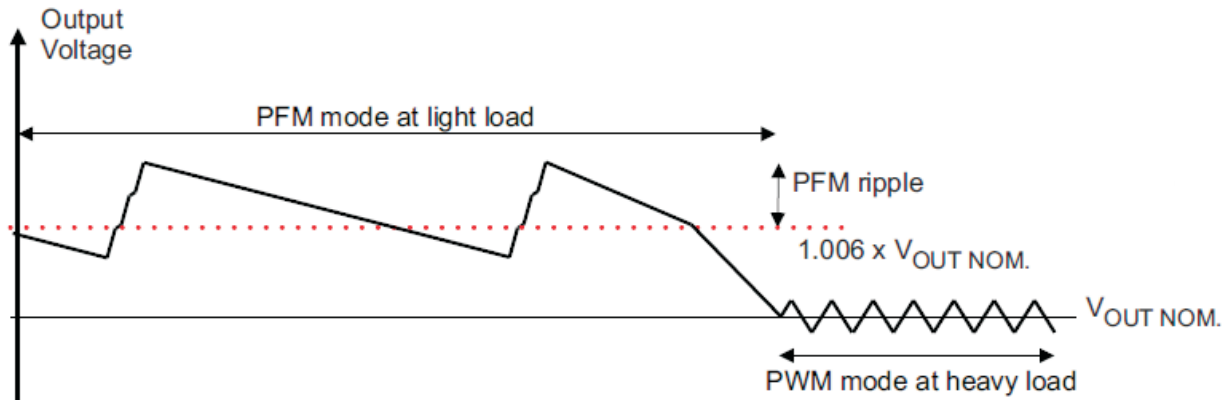
Device Functional Modes (continued)

Figure 27. Power Save
9.4.2 Standby Mode

The TPS6125x device is able to maintain its output biased at the input voltage level. In so called standby mode ($EN = 0$, $BP = 1$), the synchronous rectifier is current limited to ca. 150mA allowing an external load (e.g. audio amplifier) to be powered with a restricted supply. The output voltage is slightly reduced due to voltage drop across the rectifier MOSFET and the inductor DC resistance. The device consumes only a standby current of 21 μ A (typ).

Table 2. Operating Mode Control

OPERATING MODE	EN	BP
Shutdown, True Load Disconnect (SD)	0	0
Standby Mode, Output Pre-Biased (SM)	0	1
Boost Operating Mode (BST)	1	0
	1	1

10 Application and Implementation

NOTE

Information in the following applications sections is not part of the TI component specification, and TI does not warrant its accuracy or completeness. TI's customers are responsible for determining suitability of components for their purposes. Customers should validate and test their design implementation to confirm system functionality.

10.1 Application Information

With a wide input voltage range of 2.3 V to 5.5 V, the TPS6125x supports applications powered by Li-Ion batteries with extended voltage range. Intended for low-power applications, it supports up to 800-mA load current from a battery discharged as low as 2.65 V and allows the use of low cost chip inductor and capacitors. Different fixed voltage output versions are available from 3.15 V to 5.0 V. The TPS6125x offers a very small solution size due to minimum amount of external components. It allows the use of small inductors and input capacitors to achieve a small solution size. During shutdown, the load is completely disconnected from the battery.

10.2 Typical Application

This section details an application with TPS61256 to output fixed 5.0 V.

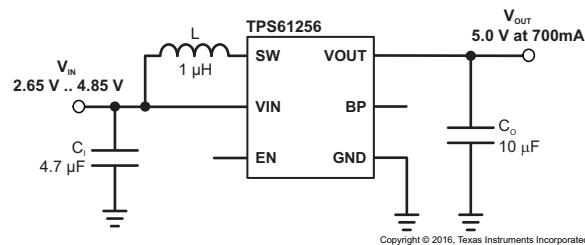

Figure 28. Smallest Solution Size Application

10.2.1 Design Requirements

In this example, TPS61256 is used to design a 5-V power supply with up to 700-mA output current capability. The TPS61256 can be powered by one-cell Li-ion battery, and in this example the input voltage range is from 2.65 V to 4.85 V.

10.2.2 Detailed Design Procedure

Table 3. List of Components

REFERENCE	DESCRIPTION	PART NUMBER, MANUFACTURER ⁽¹⁾
L ⁽²⁾	1.0 µH, 1.8 A, 48 mΩ, 3.2 x 2.5 x 1.0mm max. height	LQM32PN1R0MG0, muRata
L ⁽³⁾	1.0 µH, 3.7 A, 37 mΩ, 3.2 x 2.5 x 1.2mm max. height	DFE322512C, TOKO
C _I	4.7 µF, 6.3 V, 0402, X5R ceramic	GRM155R60J475M, muRata
C _O	10 µF, 6.3 V, 0603, X5R ceramic	GRM188R60J106ME84, muRata

(1) See [Third-Party Products Disclaimer](#)

(2) Inductor used to characterize TPS61254YFF, TPS61255YFF, TPS61256YFF and TPS61257YFF devices.

(3) Inductor used to characterize TPS61253YFF, TPS61258YFF and TPS61259YFF devices.

10.2.2.1 Inductor Selection

A boost converter normally requires two main passive components for storing energy during the conversion, an inductor and an output capacitor. It is advisable to select an inductor with a saturation current rating higher than the possible peak current flowing through the power switches.

The inductor peak current varies as a function of the load, the input and output voltages and can be estimated using [Equation 4](#).

$$I_{L(\text{PEAK})} = \frac{V_{\text{IN}} \cdot D}{2 \cdot f \cdot L} + \frac{I_{\text{OUT}}}{(1-D) \cdot \eta} \quad \text{with } D = 1 - \frac{V_{\text{IN}} \cdot \eta}{V_{\text{OUT}}} \quad (4)$$

Selecting an inductor with insufficient saturation performance can lead to excessive peak current in the converter. This could eventually harm the device and reduce its reliability.

When selecting the inductor, as well as the inductance, parameters of importance are: maximum current rating, series resistance, and operating temperature. The inductor DC current rating should be greater (by some margin) than the maximum input average current, refer to [Equation 5](#) and [Current Limit Operation](#) section for more details.

$$I_{L(\text{DC})} = \frac{V_{\text{OUT}}}{V_{\text{IN}}} \cdot \frac{1}{\eta} \cdot I_{\text{OUT}} \quad (5)$$

The TPS6125x series of step-up converters have been optimized to operate with a effective inductance in the range of 0.7 μH to 2.9 μH and with output capacitors in the range of 10 μF to 47 μF . The internal compensation is optimized for an output filter of $L = 1 \mu\text{H}$ and $C_O = 10 \mu\text{F}$. Larger or smaller inductor values can be used to optimize the performance of the device for specific operating conditions. For more details, see the [Checking Loop Stability](#) section.

In high-frequency converter applications, the efficiency is essentially affected by the inductor AC resistance (i.e. quality factor) and to a smaller extent by the inductor DCR value. To achieve high efficiency operation, care should be taken in selecting inductors featuring a quality factor above 25 at the switching frequency. Increasing the inductor value produces lower RMS currents, but degrades transient response. For a given physical inductor size, increased inductance usually results in an inductor with lower saturation current.

The total losses of the coil consist of both the losses in the DC resistance, $R_{(\text{DC})}$, and the following frequency-dependent components:

- The losses in the core material (magnetic hysteresis loss, especially at high switching frequencies)
- Additional losses in the conductor from the skin effect (current displacement at high frequencies)
- Magnetic field losses of the neighboring windings (proximity effect)
- Radiation losses

The following inductor series from different suppliers have been used with the TPS6125x converters.

Table 4. List of Inductors

MANUFACTURER ⁽¹⁾	SERIES	DIMENSIONS (in mm)
HITACHI METALS	KSLI-322512BL1-1R0	3.2 x 2.5 x 1.2 max. height
MURATA	LQM32PN1R0MG0	3.2 x 2.5 x 1.0 max. height
	LQM2HPN1R0MG0	2.5 x 2.0 x 1.0 max. height
	LQM21PN1R5MC0	2.0 x 1.2 x 0.55 max height
TOKO	DFE322512C-1R0	3.2 x 2.5 x 1.2 max. height
	MDT2012-CLR1R0AM	2.0 x 1.2 x 0.58 max height

(1) See [Third-Party Products Disclaimer](#)

10.2.2.2 Output Capacitor

For the output capacitor, it is recommended to use small ceramic capacitors placed as close as possible to the V_{OUT} and GND pins of the IC. If, for any reason, the application requires the use of large capacitors which can not be placed close to the IC, using a smaller ceramic capacitor in parallel to the large one is highly recommended. This small capacitor should be placed as close as possible to the V_{OUT} and GND pins of the IC. To get an estimate of the recommended minimum output capacitance, [Equation 6](#) can be used.

$$C_{\text{MIN}} = \frac{I_{\text{OUT}} \cdot (V_{\text{OUT}} - V_{\text{IN}})}{f \cdot \Delta V \cdot V_{\text{OUT}}} \quad (6)$$

Where f is the switching frequency which is 3.5 MHz (typ.) and ΔV is the maximum allowed output ripple.

With a chosen ripple voltage of 20mV, a minimum effective capacitance of 9µF is needed. The total ripple is larger due to the ESR of the output capacitor. This additional component of the ripple can be calculated using [Equation 7](#)

$$V_{ESR} = I_{OUT} \cdot R_{ESR} \quad (7)$$

An MLCC capacitor with twice the value of the calculated minimum should be used due to DC bias effects. This is required to maintain control loop stability. The output capacitor requires either an X7R or X5R dielectric. Y5V and Z5U dielectric capacitors, aside from their wide variation in capacitance over temperature, become resistive at high frequencies. There are no additional requirements regarding minimum ESR. Larger capacitors cause lower output voltage ripple as well as lower output voltage drop during load transients but the total output capacitance value should not exceed ca. 50µF.

DC bias effect: high cap. ceramic capacitors exhibit DC bias effects, which have a strong influence on the device's effective capacitance. Therefore the right capacitor value has to be chosen very carefully. Package size and voltage rating in combination with material are responsible for differences between the rated capacitor value and its effective capacitance. For instance, a 10-µF X5R 6.3-V 0603 MLCC capacitor would typically show an effective capacitance of less than 4 µF (under 5 V bias condition, high temperature).

In applications featuring high pulsed load currents (e.g. TPS61253 based solution) it is recommended to run the converter with a reasonable amount of effective output capacitance, for instance x2 10-µF X5R 6.3-V 0603 MLCC capacitors connected in parallel.

10.2.2.3 Input Capacitor

Multilayer ceramic capacitors are an excellent choice for input decoupling of the step-up converter as they have extremely low ESR and are available in small footprints. Input capacitors should be located as close as possible to the device. While a 4.7-µF input capacitor is sufficient for most applications, larger values may be used to reduce input current ripple without limitations.

Take care when using only ceramic input capacitors. When a ceramic capacitor is used at the input and the power is being supplied through long wires, such as from a wall adapter, a load step at the output can induce ringing at the VIN pin. This ringing can couple to the output and be mistaken as loop instability or could even damage the part. Additional "bulk" capacitance (electrolytic or tantalum) should in this circumstance be placed between C₁ and the power source lead to reduce ringing that can occur between the inductance of the power source leads and C₁.

10.2.2.4 Checking Loop Stability

The first step of circuit and stability evaluation is to look from a steady-state perspective at the following signals:

- Switching node, SW
- Inductor current, I_L
- Output ripple voltage, V_{OUT(AC)}

These are the basic signals that need to be measured when evaluating a switching converter. When the switching waveform shows large duty cycle jitter or the output voltage or inductor current shows oscillations, the regulation loop may be unstable. This is often a result of board layout and/or L-C combination.

As a next step in the evaluation of the regulation loop, the load transient response is tested. The time between the application of the load transient and the turn on of the P-channel MOSFET, the output capacitor must supply all of the current required by the load. V_{OUT} immediately shifts by an amount equal to ΔI_(LOAD) × ESR, where ESR is the effective series resistance of C_{OUT}. ΔI_(LOAD) begins to charge or discharge C_{OUT} generating a feedback error signal used by the regulator to return V_{OUT} to its steady-state value. The results are most easily interpreted when the device operates in PWM mode.

During this recovery time, V_{OUT} can be monitored for settling time, overshoot or ringing that helps judge the converter's stability. Without any ringing, the loop has usually more than 45° of phase margin. Because the damping factor of the circuitry is directly related to several resistive parameters (e.g., MOSFET r_{DS(on)}) that are temperature dependant, the loop stability analysis has to be done over the input voltage range, load current range, and temperature range.

10.2.3 Application Curves

	FIGURE
PFM operation	Figure 29
PWM operation	Figure 30
Combined line/load transient response	Figure 31
Load transient response	Figure 32, Figure 34
AC load transient response	Figure 33, Figure 35
Start-up	Figure 36, Figure 37

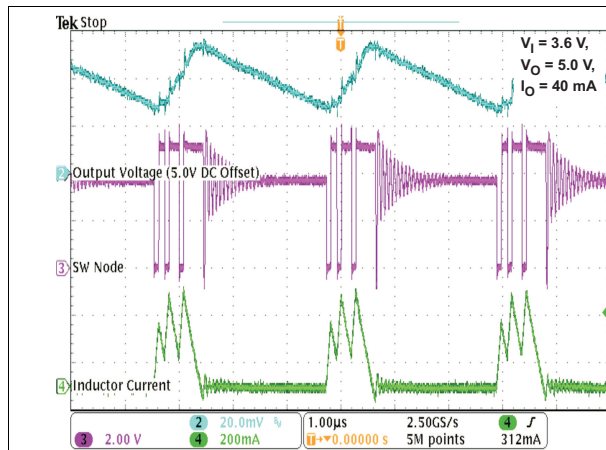

Figure 29. Power-Save Mode Operation

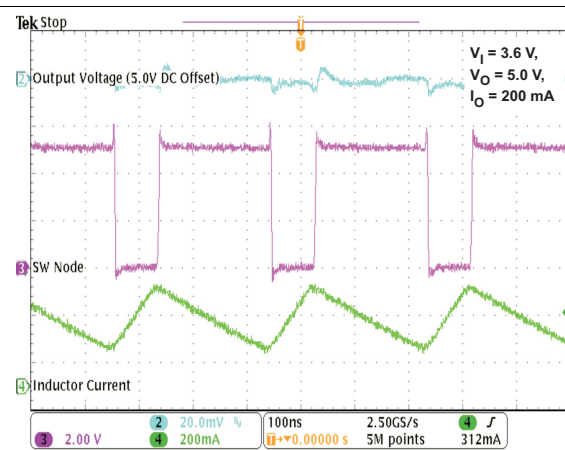

Figure 30. PWM Operation

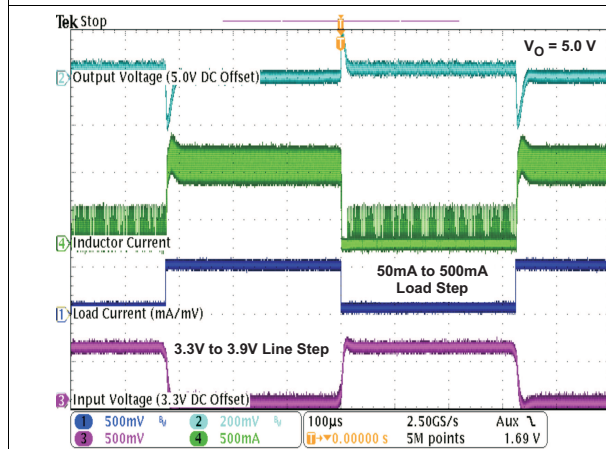

Figure 31. Combined Line/Load Transient Response

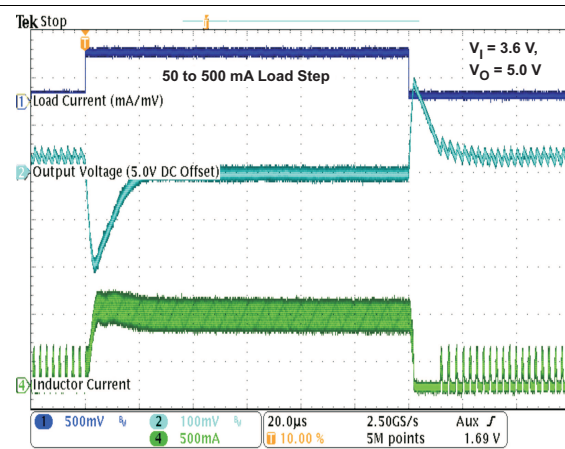

Figure 32. Load Transient Response in PFM/PWM Operation

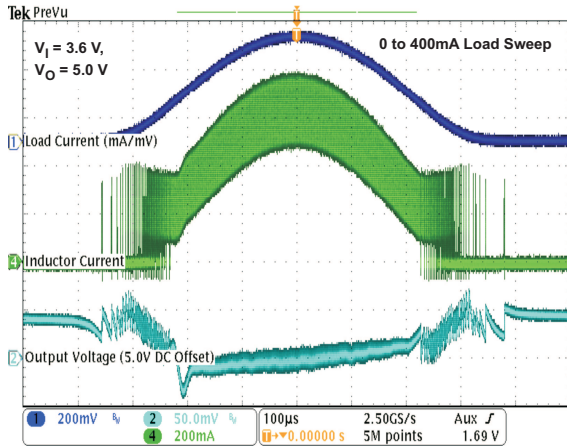

Figure 33. AC Load Transient Response

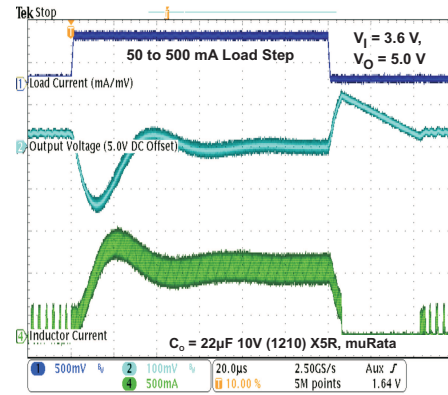

Figure 34. Load Transient Response in PFM/PWM Operation

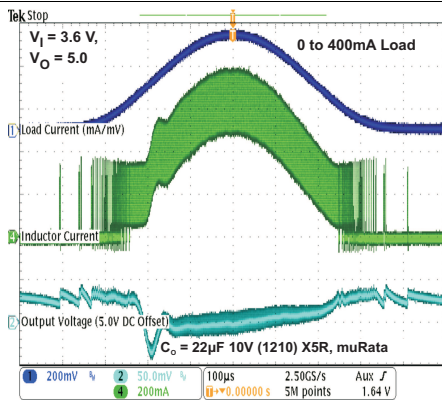

Figure 35. AC Load Transient Response

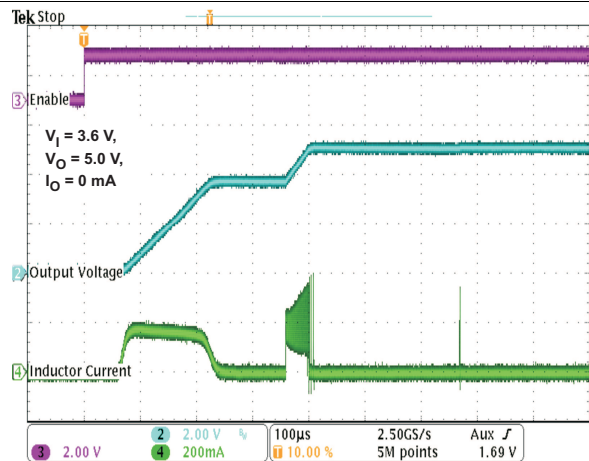

Figure 36. Start-Up

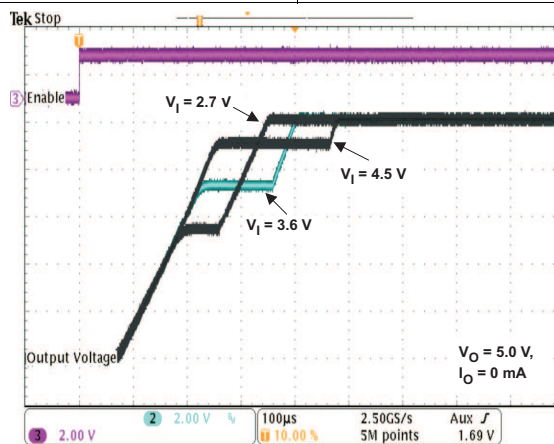

Figure 37. Start-Up

10.3 System Examples

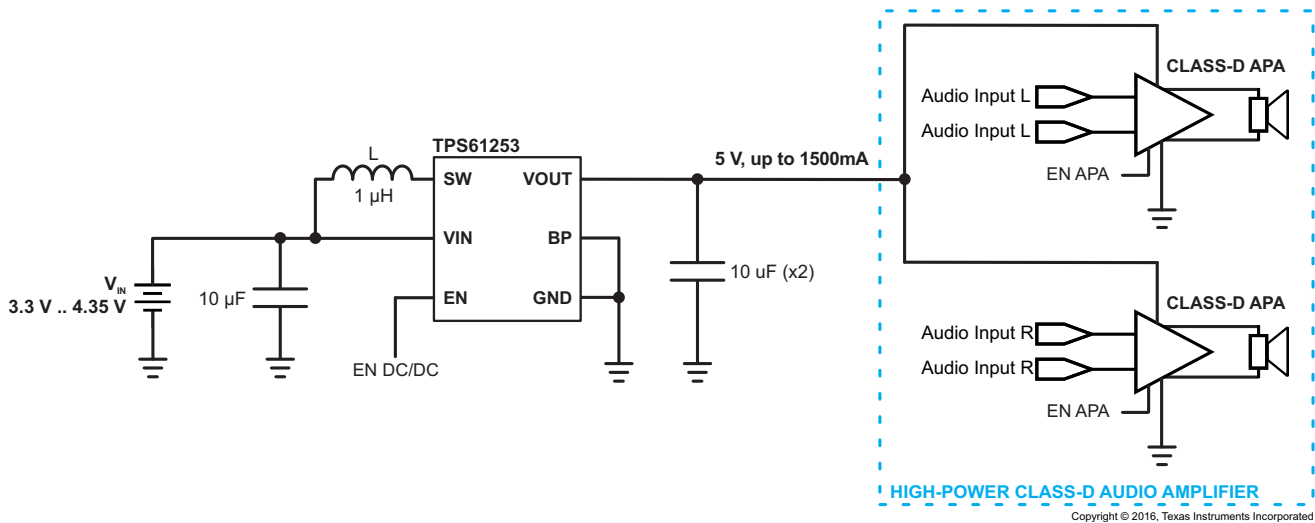

Figure 38. "Boosted" Stereo Audio Power Supply

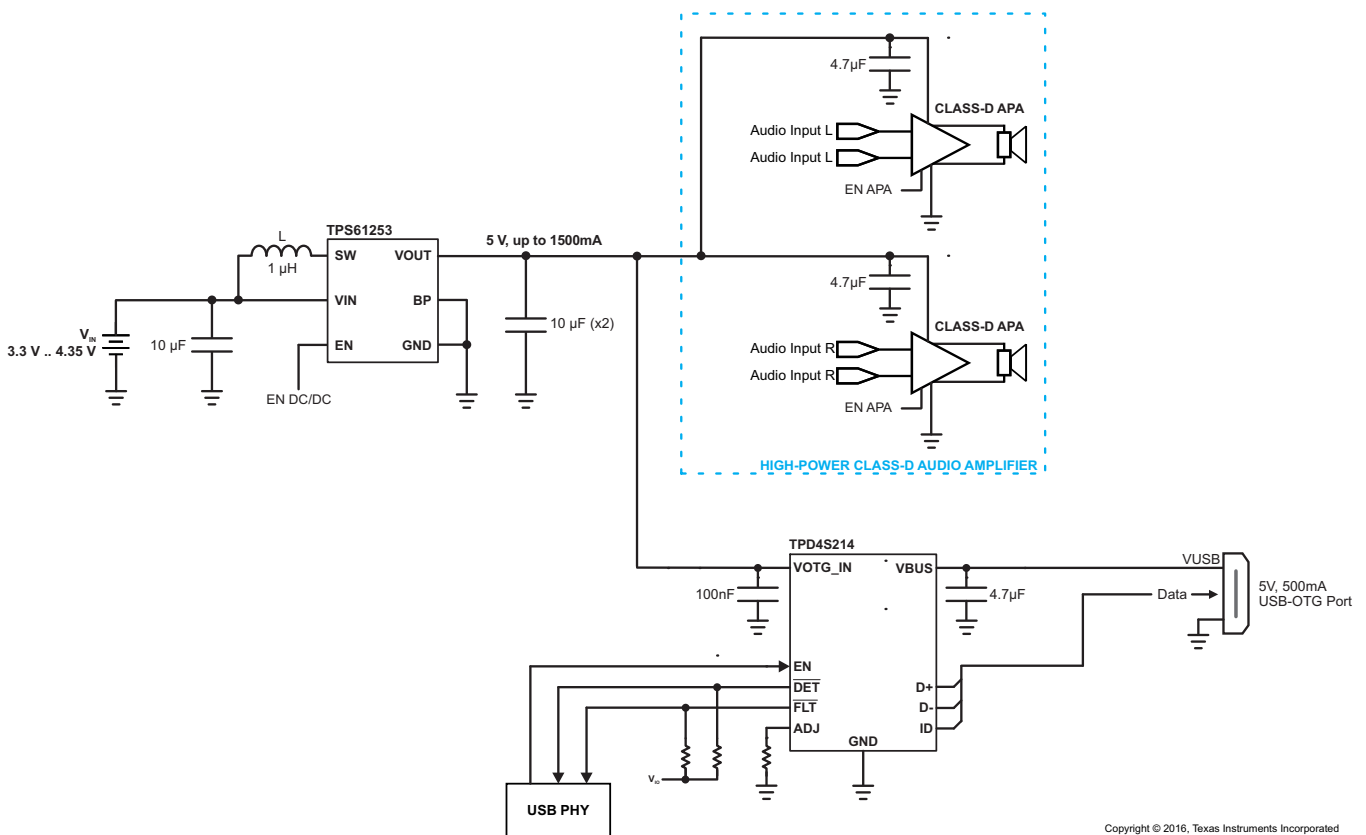

Figure 39. Single Cell Li-Ion Power Solution for Tablet PCs Featuring "Boosted" Audio Power Supply and USB-OTG I/F

System Examples (continued)

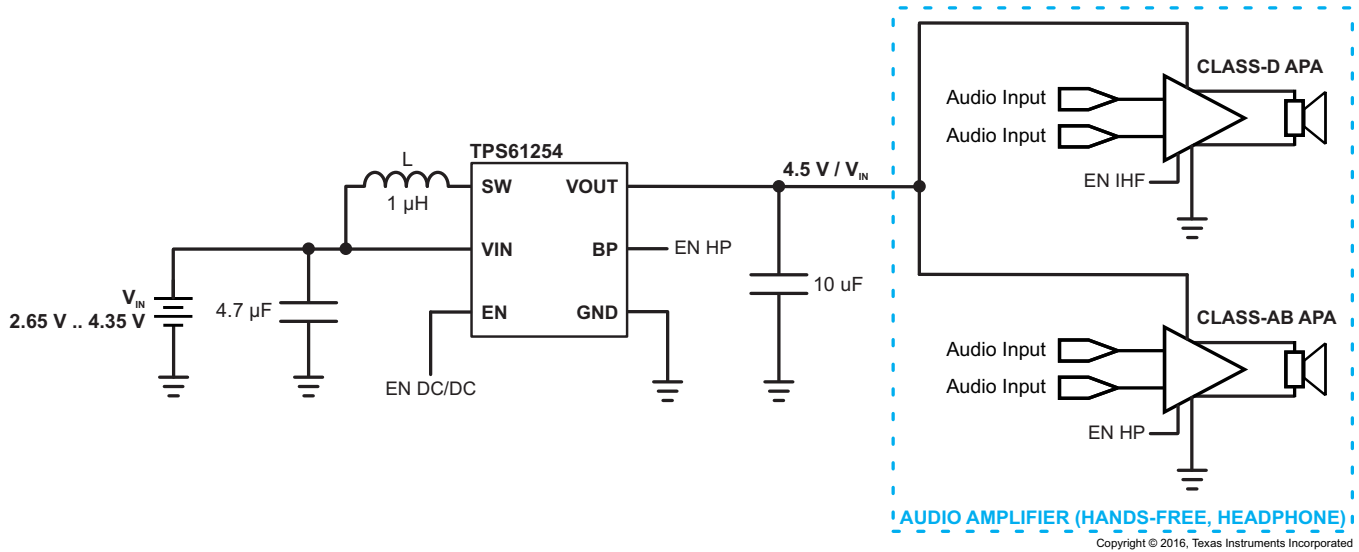

Figure 40. Combined Audio Amplifier Power Supply

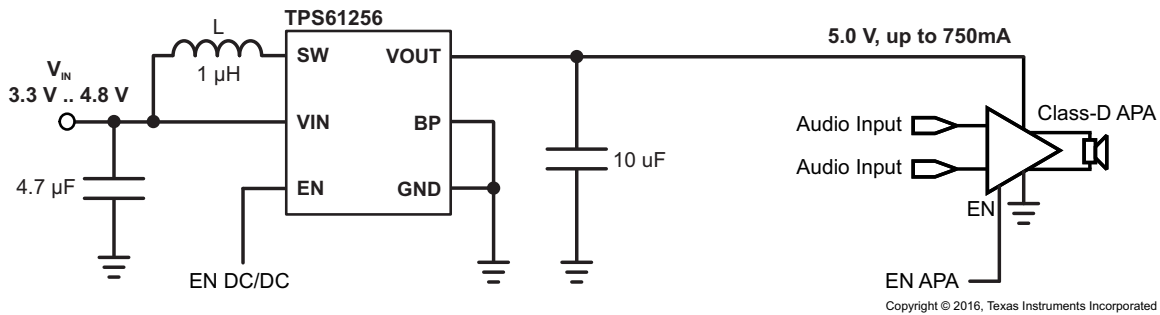

Figure 41. "Boosted" Audio Power Supply

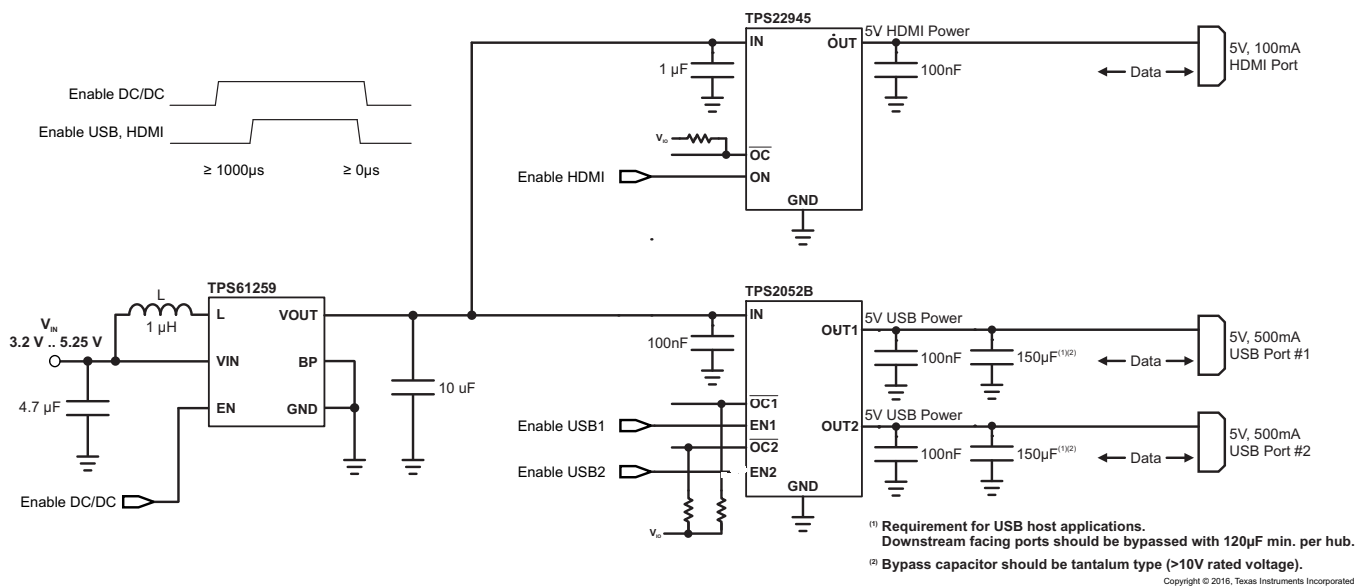

Figure 42. Single Cell Li-Ion Power Solution for Tablet PCs Featuring x2 USB Host Ports, HDMI I/F

11 Power Supply Recommendations

The power supply can be three-cell alkaline, NiCd or NiMH, or one-cell Li-Ion or Li-Polymer battery. The input supply should be well regulated with the rating of TPS6125x. If the input supply is located more than a few inches from the device, additional bulk capacitance may be required in addition to the ceramic bypass capacitors. An electrolytic or tantalum capacitor with a value of 47 μF is a typical choice.

12 Layout

12.1 Layout Guidelines

For all switching power supplies, the layout is an important step in the design, especially at high peak currents and high switching frequencies. If the layout is not carefully done, the regulator could show stability problems as well as EMI problems. Therefore, use wide and short traces for the main current path and for the power ground tracks. The input capacitor, output capacitor, and the inductor should be placed as close as possible to the IC. Use a common ground node for power ground and a different one for control ground to minimize the effects of ground noise. Connect these ground nodes at any place close to the ground pins of the IC.

12.2 Layout Example

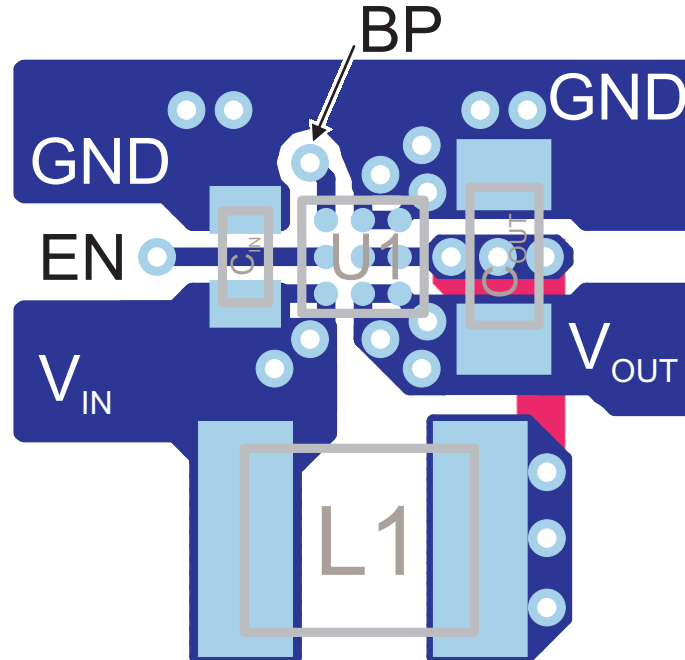

Figure 43. Suggested Layout (Top)

12.3 Thermal Considerations

Implementation of integrated circuits in low-profile and fine-pitch surface-mount packages typically requires special attention to power dissipation. Many system-dependent issues such as thermal coupling, airflow, added heat sinks and convection surfaces, and the presence of other heat-generating components affect the power-dissipation limits of a given component.

Three basic approaches for enhancing thermal performance are listed below:

- Improving the power dissipation capability of the PCB design
- Improving the thermal coupling of the component to the PCB
- Introducing airflow in the system

As power demand in portable designs is more and more important, designers must figure the best trade-off between efficiency, power dissipation and solution size. Due to integration and miniaturization, junction temperature can increase significantly which could lead to bad application behaviors (i.e. premature thermal shutdown or worst case reduce device reliability).

Junction-to-ambient thermal resistance is highly application and board-layout dependent. In applications where high maximum power dissipation exists (e.g. TPS61253 or TPS61259 based solutions), special care must be paid to thermal dissipation issues in board design. The device operating junction temperature (T_J) should be kept below 125°C.

13 Device and Documentation Support

13.1 Device Support

13.1.1 Third-Party Products Disclaimer

TI'S PUBLICATION OF INFORMATION REGARDING THIRD-PARTY PRODUCTS OR SERVICES DOES NOT CONSTITUTE AN ENDORSEMENT REGARDING THE SUITABILITY OF SUCH PRODUCTS OR SERVICES OR A WARRANTY, REPRESENTATION OR ENDORSEMENT OF SUCH PRODUCTS OR SERVICES, EITHER ALONE OR IN COMBINATION WITH ANY TI PRODUCT OR SERVICE.

13.2 Related Links

The table below lists quick access links. Categories include technical documents, support and community resources, tools and software, and quick access to sample or buy.

Table 5. Related Links

PARTS	PRODUCT FOLDER	SAMPLE & BUY	TECHNICAL DOCUMENTS	TOOLS & SOFTWARE	SUPPORT & COMMUNITY
TPS61253	Click here	Click here	Click here	Click here	Click here
TPS61254	Click here	Click here	Click here	Click here	Click here
TPS61256	Click here	Click here	Click here	Click here	Click here
TPS61258	Click here	Click here	Click here	Click here	Click here
TPS61259	Click here	Click here	Click here	Click here	Click here
TPS612592	Click here	Click here	Click here	Click here	Click here

13.3 Receiving Notification of Documentation Updates

To receive notification of documentation updates — go to the product folder for your device on ti.com. In the upper right-hand corner, click the *Alert me* button to register and receive a weekly digest of product information that has changed (if any). For change details, check the revision history of any revised document.

13.4 Community Resources

The following links connect to TI community resources. Linked contents are provided "AS IS" by the respective contributors. They do not constitute TI specifications and do not necessarily reflect TI's views; see TI's [Terms of Use](#).

TI E2E™ Online Community *TI's Engineer-to-Engineer (E2E) Community*. Created to foster collaboration among engineers. At e2e.ti.com, you can ask questions, share knowledge, explore ideas and help solve problems with fellow engineers.

Design Support *TI's Design Support* Quickly find helpful E2E forums along with design support tools and contact information for technical support.

13.5 Trademarks

E2E is a trademark of Texas Instruments.
All other trademarks are the property of their respective owners.

13.6 Electrostatic Discharge Caution



These devices have limited built-in ESD protection. The leads should be shorted together or the device placed in conductive foam during storage or handling to prevent electrostatic damage to the MOS gates.

13.7 Glossary

[SLYZ022](#) — *TI Glossary*.

This glossary lists and explains terms, acronyms, and definitions.

14 Mechanical, Packaging, and Orderable Information

The following pages include mechanical, packaging, and orderable information. This information is the most current data available for the designated devices. This data is subject to change without notice and revision of this document. For browser-based versions of this data sheet, refer to the left-hand navigation.

14.1 Package Summary

**Chip Scale Package
(Bottom View)**

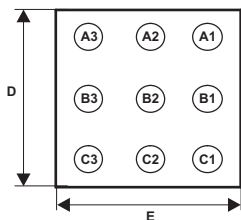

**Chip Scale Package
(Top View)**

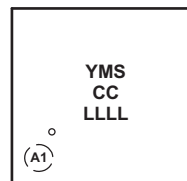

Code:

- YM - 2 digit date code
- S - assembly site code
- CC - chip code (see ordering table)
- LLLL - lot trace code

14.1.1 Package Dimensions

The dimensions for the YFF-9 package are shown in [Table 6](#). See the package drawing at the end of this data sheet.

Table 6. YFF-9 Package Dimensions

PACKAGED DEVICES	D	E
TPS6125xYFF	max = 1.236mm; min = 1.176 mm	max = 1.336 mm, min = 1.276 mm

EXAMPLE BOARD LAYOUT

YFF0009

DSBGA - 0.625 mm max height

DIE SIZE BALL GRID ARRAY

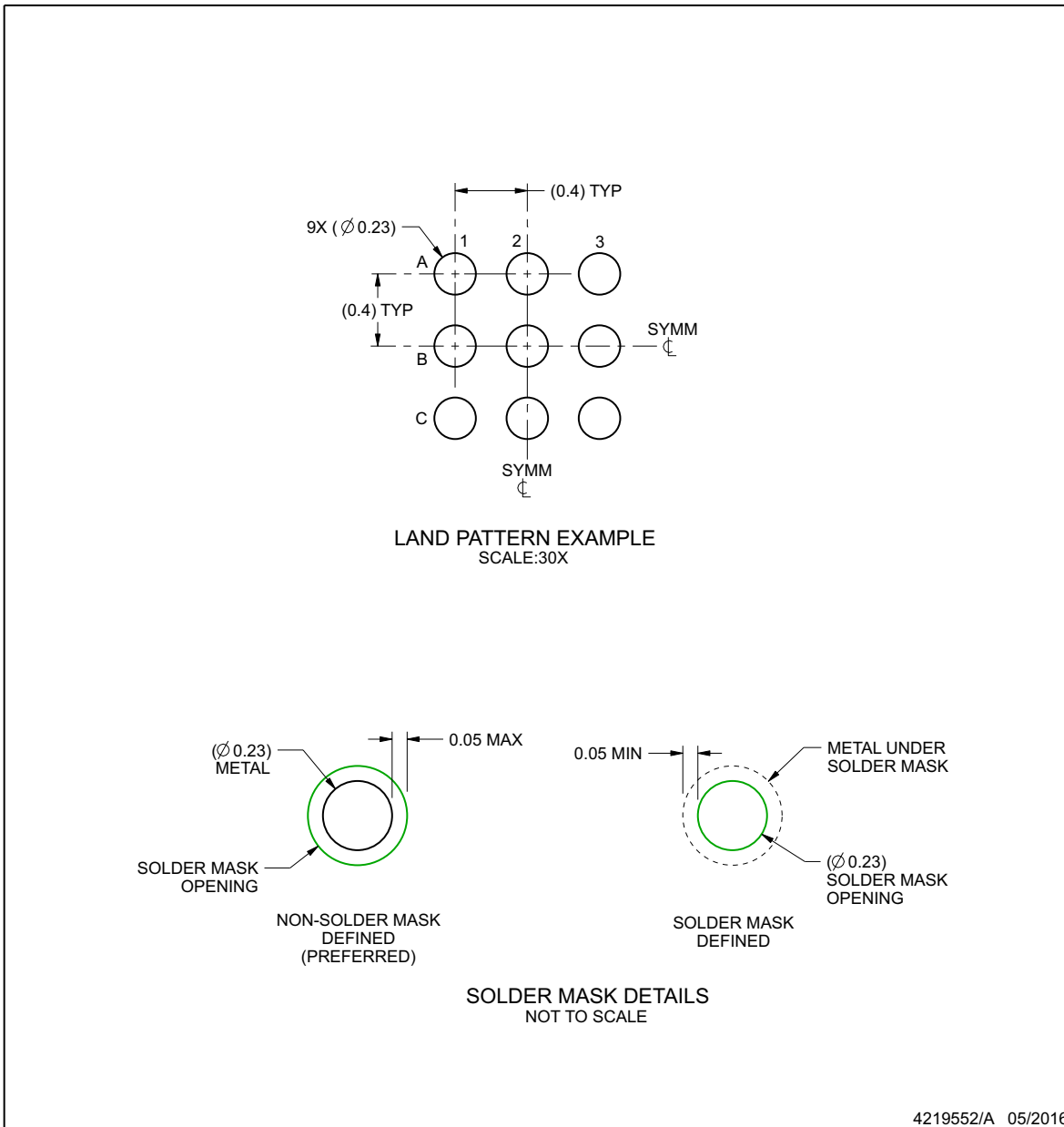

4219552/A 05/2016

NOTES: (continued)

- Final dimensions may vary due to manufacturing tolerance considerations and also routing constraints. For more information, see Texas Instruments literature number SNVA009 (www.ti.com/lit/snva009).

EXAMPLE STENCIL DESIGN

YFF0009

DSBGA - 0.625 mm max height

DIE SIZE BALL GRID ARRAY

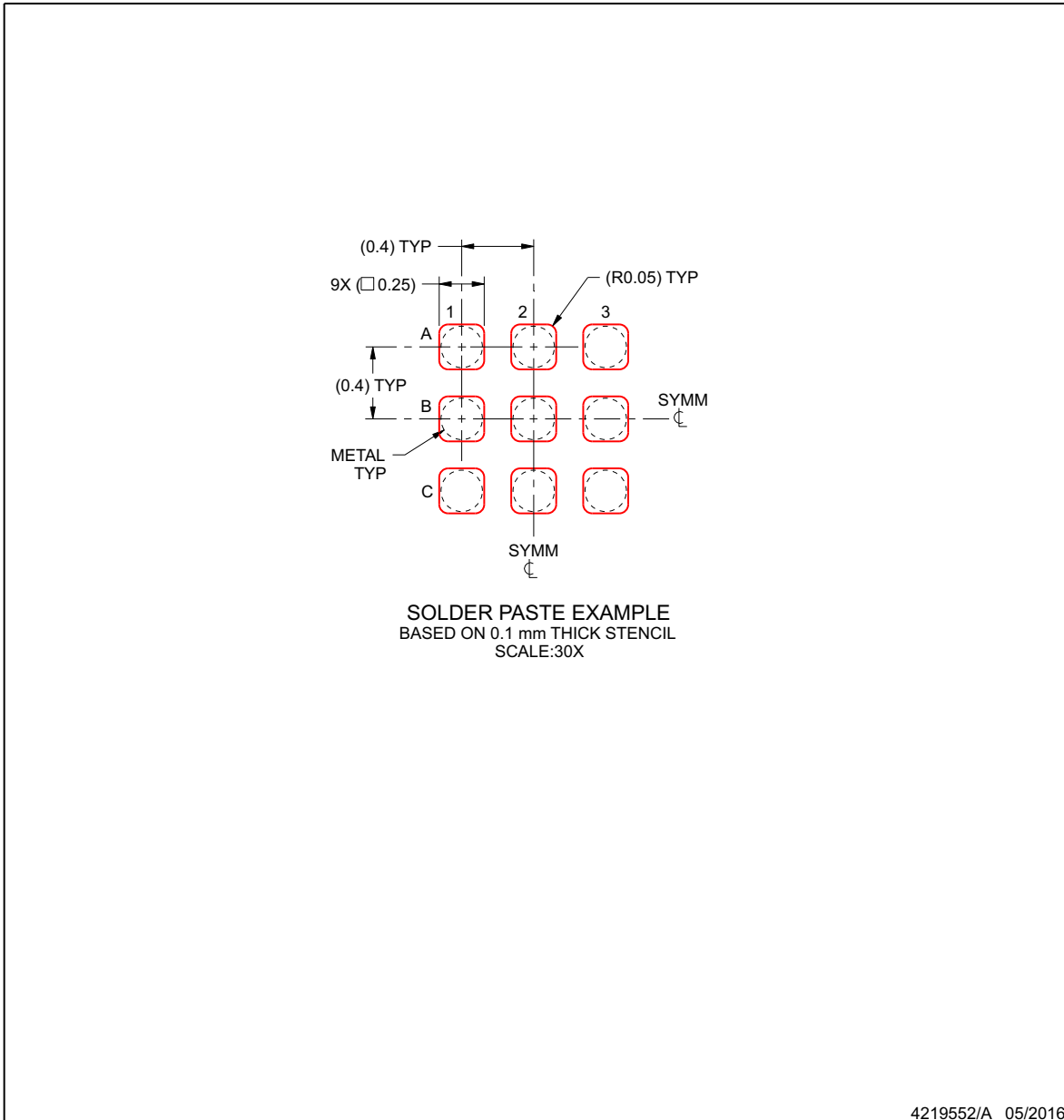

NOTES: (continued)

4. Laser cutting apertures with trapezoidal walls and rounded corners may offer better paste release.

PACKAGING INFORMATION

Orderable Device	Status (1)	Package Type	Package Drawing	Pins	Package Qty	Eco Plan (2)	Lead finish/ Ball material (6)	MSL Peak Temp (3)	Op Temp (°C)	Device Marking (4/5)	Samples
TPS61253YFFR	ACTIVE	DSBGA	YFF	9	3000	RoHS & Green	SNAGCU	Level-1-260C-UNLIM	-40 to 125	SBF	Samples
TPS61253YFFT	ACTIVE	DSBGA	YFF	9	250	RoHS & Green	SNAGCU	Level-1-260C-UNLIM	-40 to 125	SBF	Samples
TPS61254YFFR	ACTIVE	DSBGA	YFF	9	3000	RoHS & Green	SNAGCU	Level-1-260C-UNLIM	-40 to 125	QWR	Samples
TPS61254YFFT	ACTIVE	DSBGA	YFF	9	250	RoHS & Green	SNAGCU	Level-1-260C-UNLIM	-40 to 125	QWR	Samples
TPS61256YFFR	ACTIVE	DSBGA	YFF	9	3000	RoHS & Green	SNAGCU	Level-1-260C-UNLIM	-40 to 125	RAV	Samples
TPS61256YFFT	ACTIVE	DSBGA	YFF	9	250	RoHS & Green	SNAGCU	Level-1-260C-UNLIM	-40 to 125	RAV	Samples
TPS61258YFFR	ACTIVE	DSBGA	YFF	9	3000	RoHS & Green	SNAGCU	Level-1-260C-UNLIM	-40 to 125	SAZ	Samples
TPS61258YFFT	ACTIVE	DSBGA	YFF	9	250	RoHS & Green	SNAGCU	Level-1-260C-UNLIM	-40 to 125	SAZ	Samples
TPS612592YFFR	ACTIVE	DSBGA	YFF	9	3000	RoHS & Green	SNAGCU	Level-1-260C-UNLIM	-40 to 125	14A	Samples
TPS612592YFFT	ACTIVE	DSBGA	YFF	9	250	RoHS & Green	SNAGCU	Level-1-260C-UNLIM	-40 to 125	14A	Samples
TPS61259YFFR	ACTIVE	DSBGA	YFF	9	3000	RoHS & Green	SNAGCU	Level-1-260C-UNLIM	-40 to 125	SAY	Samples
TPS61259YFFT	ACTIVE	DSBGA	YFF	9	250	RoHS & Green	SNAGCU	Level-1-260C-UNLIM	-40 to 125	SAY	Samples

(1) The marketing status values are defined as follows:

ACTIVE: Product device recommended for new designs.

LIFEBUY: TI has announced that the device will be discontinued, and a lifetime-buy period is in effect.

NRND: Not recommended for new designs. Device is in production to support existing customers, but TI does not recommend using this part in a new design.

PREVIEW: Device has been announced but is not in production. Samples may or may not be available.

OBSELETE: TI has discontinued the production of the device.

(2) **RoHS:** TI defines "RoHS" to mean semiconductor products that are compliant with the current EU RoHS requirements for all 10 RoHS substances, including the requirement that RoHS substance do not exceed 0.1% by weight in homogeneous materials. Where designed to be soldered at high temperatures, "RoHS" products are suitable for use in specified lead-free processes. TI may reference these types of products as "Pb-Free".

RoHS Exempt: TI defines "RoHS Exempt" to mean products that contain lead but are compliant with EU RoHS pursuant to a specific EU RoHS exemption.

Green: TI defines "Green" to mean the content of Chlorine (Cl) and Bromine (Br) based flame retardants meet JS709B low halogen requirements of <=1000ppm threshold. Antimony trioxide based flame retardants must also meet the <=1000ppm threshold requirement.

- (3) MSL, Peak Temp. - The Moisture Sensitivity Level rating according to the JEDEC industry standard classifications, and peak solder temperature.
- (4) There may be additional marking, which relates to the logo, the lot trace code information, or the environmental category on the device.
- (5) Multiple Device Markings will be inside parentheses. Only one Device Marking contained in parentheses and separated by a "~" will appear on a device. If a line is indented then it is a continuation of the previous line and the two combined represent the entire Device Marking for that device.
- (6) Lead finish/Ball material - Orderable Devices may have multiple material finish options. Finish options are separated by a vertical ruled line. Lead finish/Ball material values may wrap to two lines if the finish value exceeds the maximum column width.

Important Information and Disclaimer:The information provided on this page represents TI's knowledge and belief as of the date that it is provided. TI bases its knowledge and belief on information provided by third parties, and makes no representation or warranty as to the accuracy of such information. Efforts are underway to better integrate information from third parties. TI has taken and continues to take reasonable steps to provide representative and accurate information but may not have conducted destructive testing or chemical analysis on incoming materials and chemicals. TI and TI suppliers consider certain information to be proprietary, and thus CAS numbers and other limited information may not be available for release.

In no event shall TI's liability arising out of such information exceed the total purchase price of the TI part(s) at issue in this document sold by TI to Customer on an annual basis.

TAPE AND REEL INFORMATION

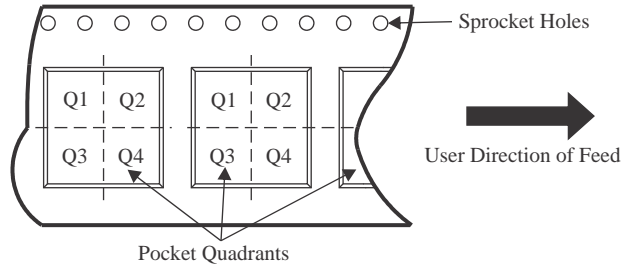
QUADRANT ASSIGNMENTS FOR PIN 1 ORIENTATION IN TAPE

*All dimensions are nominal

Device	Package Type	Package Drawing	Pins	SPQ	Reel Diameter (mm)	Reel Width W1 (mm)	A0 (mm)	B0 (mm)	K0 (mm)	P1 (mm)	W (mm)	Pin1 Quadrant
TPS61253YFFR	DSBGA	YFF	9	3000	180.0	8.4	1.41	1.31	0.69	4.0	8.0	Q1
TPS61253YFFT	DSBGA	YFF	9	250	180.0	8.4	1.41	1.31	0.69	4.0	8.0	Q1
TPS61254YFFR	DSBGA	YFF	9	3000	180.0	8.4	1.41	1.31	0.69	4.0	8.0	Q1
TPS61254YFFT	DSBGA	YFF	9	250	180.0	8.4	1.41	1.31	0.69	4.0	8.0	Q1
TPS61256YFFR	DSBGA	YFF	9	3000	180.0	8.4	1.41	1.31	0.69	4.0	8.0	Q1
TPS61256YFFT	DSBGA	YFF	9	250	180.0	8.4	1.41	1.31	0.69	4.0	8.0	Q1
TPS61258YFFR	DSBGA	YFF	9	3000	180.0	8.4	1.41	1.31	0.69	4.0	8.0	Q1
TPS61258YFFT	DSBGA	YFF	9	250	180.0	8.4	1.41	1.31	0.69	4.0	8.0	Q1
TPS61259YFFR	DSBGA	YFF	9	3000	180.0	8.4	1.41	1.31	0.69	4.0	8.0	Q1
TPS61259YFFT	DSBGA	YFF	9	250	180.0	8.4	1.41	1.31	0.69	4.0	8.0	Q1

TAPE AND REEL BOX DIMENSIONS

*All dimensions are nominal

Device	Package Type	Package Drawing	Pins	SPQ	Length (mm)	Width (mm)	Height (mm)
TPS61253YFFR	DSBGA	YFF	9	3000	182.0	182.0	20.0
TPS61253YFFT	DSBGA	YFF	9	250	182.0	182.0	20.0
TPS61254YFFR	DSBGA	YFF	9	3000	182.0	182.0	20.0
TPS61254YFFT	DSBGA	YFF	9	250	182.0	182.0	20.0
TPS61256YFFR	DSBGA	YFF	9	3000	182.0	182.0	20.0
TPS61256YFFT	DSBGA	YFF	9	250	182.0	182.0	20.0
TPS61258YFFR	DSBGA	YFF	9	3000	182.0	182.0	20.0
TPS61258YFFT	DSBGA	YFF	9	250	182.0	182.0	20.0
TPS612592YFFR	DSBGA	YFF	9	3000	182.0	182.0	20.0
TPS612592YFFT	DSBGA	YFF	9	250	182.0	182.0	20.0
TPS61259YFFR	DSBGA	YFF	9	3000	182.0	182.0	20.0
TPS61259YFFT	DSBGA	YFF	9	250	182.0	182.0	20.0

IMPORTANT NOTICE AND DISCLAIMER

TI PROVIDES TECHNICAL AND RELIABILITY DATA (INCLUDING DATA SHEETS), DESIGN RESOURCES (INCLUDING REFERENCE DESIGNS), APPLICATION OR OTHER DESIGN ADVICE, WEB TOOLS, SAFETY INFORMATION, AND OTHER RESOURCES "AS IS" AND WITH ALL FAULTS, AND DISCLAIMS ALL WARRANTIES, EXPRESS AND IMPLIED, INCLUDING WITHOUT LIMITATION ANY IMPLIED WARRANTIES OF MERCHANTABILITY, FITNESS FOR A PARTICULAR PURPOSE OR NON-INFRINGEMENT OF THIRD PARTY INTELLECTUAL PROPERTY RIGHTS.

These resources are intended for skilled developers designing with TI products. You are solely responsible for (1) selecting the appropriate TI products for your application, (2) designing, validating and testing your application, and (3) ensuring your application meets applicable standards, and any other safety, security, regulatory or other requirements.

These resources are subject to change without notice. TI grants you permission to use these resources only for development of an application that uses the TI products described in the resource. Other reproduction and display of these resources is prohibited. No license is granted to any other TI intellectual property right or to any third party intellectual property right. TI disclaims responsibility for, and you will fully indemnify TI and its representatives against, any claims, damages, costs, losses, and liabilities arising out of your use of these resources.

TI's products are provided subject to [TI's Terms of Sale](#) or other applicable terms available either on [ti.com](https://www.ti.com) or provided in conjunction with such TI products. TI's provision of these resources does not expand or otherwise alter TI's applicable warranties or warranty disclaimers for TI products.

TI objects to and rejects any additional or different terms you may have proposed.

Mailing Address: Texas Instruments, Post Office Box 655303, Dallas, Texas 75265
Copyright © 2024, Texas Instruments Incorporated





Looking for pricing, stock, or lifecycle information?

Click below to explore more details on WIN SOURCE:

 [View TPS61253YFFR on WIN SOURCE](#)

 [Texas Instruments](#) Information

Optimize Your Supply Chain with WIN SOURCE Solutions

-  Global Sourcing Solution
-  Obsolete Management
-  Cost Control Management
-  Shortage Management
-  Alternative Solution
-  Excess Inventory Management