



**THE DATASHEET OF  
TPS62304YZDR**



## 500-mA, 3-MHz SYNCHRONOUS STEP-DOWN CONVERTER IN CHIP SCALE PACKAGING

### FEATURES

- Up to 93% Efficiency at 3-MHz Operation
- Up to 500-mA Output Current at  $V_I = 2.7$  V
- 3-MHz Fixed Frequency Operation
- *Best in Class* Load and Line Transient
- Complete 1-mm Component Profile Solution
- -0.5% / +1.3% PWM DC Voltage Accuracy Over Temperature
- 35-ns Minimum On-Time
- Power-Save Mode Operation at Light Load Currents
- Fixed and Adjustable Output Voltage
- Only 86- $\mu$ A Quiescent Current
- 100% Duty Cycle for Lowest Dropout
- Synchronizable *On the Fly* to External Clock Signal
- Integrated Active Power-Down Sequencing (TPS6232x only)
- Available in a 10-Pin QFN (3 x 3 mm), 8-Pin NanoFree™, and NanoStar™ (CSP) Packaging

### APPLICATIONS

- Cell Phones, Smart-Phones
- WLAN and Bluetooth™ Applications
- Micro DC-DC Converter Modules
- PDAs, Pocket PCs
- USB-Based DSL Modems
- Digital Cameras

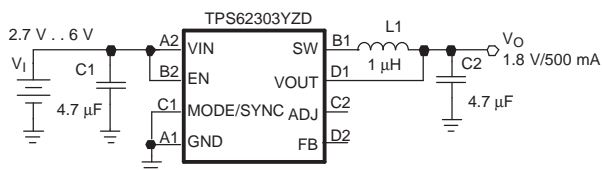

Figure 1. Smallest Solution Size Application (Fixed Output Voltage)

### DESCRIPTION

The TPS623xx device is a high-frequency synchronous step-down dc-dc converter optimized for battery-powered portable applications. Intended for low-power applications, the TPS623xx supports up to 500-mA load current and allows the use of tiny, low cost chip inductor and capacitors.

The device is ideal for mobile phones and similar portable applications powered by a single-cell Li-Ion battery or by 3-cell NiMH/NiCd batteries. With an output voltage range from 5.4 V down to 0.6 V, the device supports the low-voltage TMS320™ DSP family, processors in smart-phones, PDAs as well as notebooks, and handheld computers.

The TPS62300 operates at 3-MHz fixed switching frequency and enters the power-save mode operation at light load currents to maintain high efficiency over the entire load current range. For low noise applications, the device can be forced into fixed frequency PWM mode by pulling the MODE/SYNC pin high. The device can also be synchronized to an external clock signal in the range of 3 MHz. In the shutdown mode, the current consumption is reduced to less than 1  $\mu$ A.

The TPS623xx is available in a 10-pin leadless package (3 x 3 mm QFN) and an 8-pin chip-scale package (CSP).

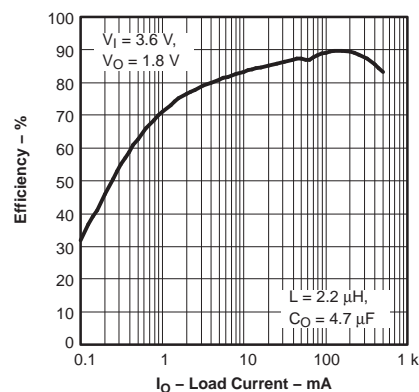

Figure 2. Efficiency vs Load Current



Please be aware that an important notice concerning availability, standard warranty, and use in critical applications of Texas Instruments semiconductor products and disclaimers thereto appears at the end of this data sheet.

NanoFree, NanoStar, TMS320 are trademarks of Texas Instruments.  
Bluetooth is a trademark of Bluetooth SIG, Inc.  
PowerPAD is a trademark of Texas Instruments.



These devices have limited built-in ESD protection. The leads should be shorted together or the device placed in conductive foam during storage or handling to prevent electrostatic damage to the MOS gates.

### ORDERING INFORMATION

T <sub>A</sub>	PART NUMBER	OUTPUT VOLTAGE	UNDERVOLTAGE LOCKOUT	PACKAGE	ORDERING <sup>(1)(2)</sup>	PACKAGE MARKING
-40°C to 85°C	TPS62300	Adjustable	2.4 V	QFN-10	TPS62300DRC	AMN
			2.4 V	CSP-8	TPS62300YZD	N/A
	TPS62301	1.5 V	2.4 V	QFN-10	TPS62301DRC	AMO
			2.4 V	CSP-8	TPS62301YZD	N/A
	TPS62302	1.6 V	2.4 V	QFN-10	TPS62302DRC	AMQ
			2.4 V	CSP-8	TPS62302YZD	N/A
	TPS62303	1.8 V	2.4 V	QFN-10	TPS62303DRC	AMR
			2.4 V	CSP-8	TPS62303YZD	N/A
	TPS62304	1.2 V	2.4 V	QFN-10	TPS62304DRC	AMS
			2.4 V	CSP-8	TPS62304YZD	N/A
	TPS62305	1.875 V	2.4 V	QFN-10	TPS62305DRC	ANU
			2.4 V	CSP-8	TPS62305YZD	N/A
	TPS62311	1.5 V	2 V	CSP-8	TPS62311YZD	N/A
	TPS62313	1.8 V	2 V	CSP-8	TPS62313YZD	N/A
	TPS62315	1.875 V	2 V	CSP-8	TPS62315YZ	N/A
	TPS62320	Adjustable	2.4 V	QFN-10	TPS62320DRC	AMX
			2.4 V	CSP-8	TPS62320YZD	N/A
			2.4 V	CSP-8	TPS62320YED	N/A
TPS62321	1.5 V	2.4 V	QFN-10	TPS62321DRC	AMY	
		2.4 V	CSP-8	TPS62321YZD	N/A	
		2.4 V	CSP-8	TPS62321YED	N/A	

- (1) The YZD, YED and YZ packages are available in tape and reel. Add a R suffix (e.g. TPS62300YxDR) to order quantities of 3000 parts. Add a T suffix (e.g. TPS62300YxDT) to order quantities of 250 parts. The DRC package is available in tape and reel. Add a R suffix (e.g. TPS62300DRCR) to order quantities of 3000 parts.
- (2) For the most current package and ordering information, see the Package Option Addendum at the end of this document, or see the TI website at [www.ti.com](http://www.ti.com).

## ABSOLUTE MAXIMUM RATINGS

over operating free-air temperature range (unless otherwise noted)<sup>(1)</sup>

		UNIT
V <sub>I</sub>	Voltage at VIN, AVIN <sup>(2)</sup>	-0.3 V to 7 V
	Voltage at SW <sup>(2)</sup>	-0.3 V to 7 V
	Voltage at FB, ADJ	-0.3 V to 3.6 V
	Voltage at EN, MODE/SYNC <sup>(2)</sup>	-0.3 V to V <sub>I</sub> + 0.3 V
	Voltage at VOUT <sup>(2)</sup>	0.3 V to 5.4 V
I <sub>O</sub>	Continuous output current	500 mA
	Power dissipation	Internally limited
T <sub>A</sub>	Operating temperature range	-40°C to 85°C
T <sub>J</sub> (max)	Maximum operating junction temperature	150°C
T <sub>stg</sub>	Storage temperature range	-65°C to 150°C
ESD rating <sup>(3)</sup>	Human body model at AVIN, FB, ADJ, EN, MODE_SYNC, VOUT	2 kV
	Human body model at VIN, SW	1 kV
	Charge device model	1.5 kV

(1) Stresses beyond those listed under "absolute maximum ratings" may cause permanent damage to the device. These are stress ratings only and functional operation of the device at these or any other conditions beyond those indicated under "recommended operating conditions" is not implied. Exposure to absolute-maximum-rated conditions for extended periods may affect device reliability.

(2) All voltage values are with respect to network ground terminal.

(3) The human body model is a 100-pF capacitor discharged through a 1.5-kΩ resistor into each pin.

## DISSIPATION RATINGS<sup>(1)</sup>

PACKAGE	R <sub>θJA</sub> <sup>(2)</sup>	POWER RATING FOR T <sub>A</sub> ≤ 25°C	DERATING FACTOR ABOVE T <sub>A</sub> = 25°C
DRC	49°C/W	2050 mW	21 mW/°C
YZD	250°C/W	400 mW	4 mW/°C
YED	250°C/W	400 mW	4 mW/°C
YZ	250°C/W	400 mW	4 mW/°C

- (1) Maximum power dissipation is a function of T<sub>J</sub>(max), θ<sub>JA</sub> and T<sub>A</sub>. The maximum allowable power dissipation at any allowable ambient temperature is P<sub>D</sub> = [T<sub>J</sub>(max)-T<sub>A</sub>] / θ<sub>JA</sub>  
 (2) This thermal data is measured with low-K board (1 layer board according to JESD51-7 JEDEC standard).

## ELECTRICAL CHARACTERISTICS

V<sub>I</sub> = 3.6 V, V<sub>O</sub> = 1.6 V, EN = V<sub>I</sub>, MODE/SYNC = GND, L = 1 μH, C<sub>O</sub> = 10 μF, T<sub>A</sub> = -40°C to 85°C, typical values are at T<sub>A</sub> = 25°C (unless otherwise noted)

PARAMETER		TEST CONDITIONS	MIN	TYP	MAX	UNIT	
<b>SUPPLY CURRENT</b>							
V <sub>I</sub>	Input voltage range		2.7		6	V	
I <sub>Q</sub>	Operating quiescent current	TPS6230x TPS6232x	I <sub>O</sub> = 0 mA. PFM mode enabled, device not switching	86	105	μA	
		TPS6231x	I <sub>O</sub> = 0 mA. PFM mode enabled, device not switching	86	120	μA	
		TPS6230x TPS6231x TPS6232x	I <sub>O</sub> = 0 mA. Switching with no load (MODE/SYNC = VIN)	3.6		mA	
I <sub>(SD)</sub>	Shutdown current	EN = GND	0.1		1	μA	
UVLO	Undervoltage lockout threshold	TPS6230x TPS6232x		2.40	2.55	V	
		TPS6231x		2.00	2.20	V	
<b>ENABLE, MODE/SYNC</b>							
V <sub>(EN)</sub>	EN high-level input voltage		1.2			V	
V <sub>(MODE/SYNC)</sub>	MODE/SYNC high-level input voltage		1.3			V	
V <sub>(EN)</sub> , V <sub>(MODE/SYNC)</sub>	EN, MODE/SYNC low-level input voltage				0.4	V	
I <sub>(EN)</sub> , I <sub>(MODE/SYNC)</sub>	EN, MODE/SYNC input leakage current	EN, MODE/SYNC = GND or VIN		0.01	1	μA	
<b>POWER SWITCH</b>							
r <sub>DS(on)</sub>	P-channel MOSFET on resistance	TPS6230x TPS6231x TPS6232x	V <sub>I</sub> = V <sub>(GS)</sub> = 3.6 V	420	750	mΩ	
			V <sub>I</sub> = V <sub>(GS)</sub> = 2.8 V	520	1000	mΩ	
I <sub>lkg</sub>	P-channel leakage current, PMOS		V <sub>(DS)</sub> = 6 V		1	μA	
r <sub>DS(on)</sub>	N-channel MOSFET on resistance		V <sub>I</sub> = V <sub>(GS)</sub> = 3.6 V	330	750	mΩ	
			V <sub>I</sub> = V <sub>(GS)</sub> = 2.8 V	400	1000	mΩ	
R <sub>(DIS)</sub>	Discharge resistor for power-down sequence (TPS6232x only)			30	50	Ω	
I <sub>lkg</sub>	N-channel leakage current, NMOS		V <sub>(DS)</sub> = 6 V		1	μA	
	P-MOS current limit		2.7 V ≤ V <sub>I</sub> ≤ 6 V	670	780	890	mA
	N-MOS current limit - sourcing		2.7 V ≤ V <sub>I</sub> ≤ 6 V	550	720	890	mA
	N-MOS current limit - sinking		2.7 V ≤ V <sub>I</sub> ≤ 6 V	-460	-600	-740	mA
	Input current limit under short-circuit conditions		V <sub>O</sub> = 0 V	390		mA	
	Thermal shutdown			150		°C	
	Thermal shutdown hysteresis			20		°C	

## ELECTRICAL CHARACTERISTICS (continued)

$V_I = 3.6\text{ V}$ ,  $V_O = 1.6\text{ V}$ ,  $EN = V_I$ ,  $MODE/SYNC = GND$ ,  $L = 1\text{ }\mu\text{H}$ ,  $C_O = 10\text{ }\mu\text{F}$ ,  $T_A = -40^\circ\text{C}$  to  $85^\circ\text{C}$ , typical values are at  $T_A = 25^\circ\text{C}$  (unless otherwise noted)

PARAMETER		TEST CONDITIONS		MIN	TYP	MAX	UNIT	
<b>OSCILLATOR</b>								
$f_{SW}$	Oscillator frequency			2.65	3	3.35	MHz	
$f_{(SYNC)}$	Synchronization range			2.65		3.35	MHz	
	Duty cycle of external clock signal			20%		80%		
<b>OUTPUT</b>								
$V_O$	Adjustable output voltage range	TPS62300 TPS62320		0.6		5.4	V	
$V_{(FB)}$	Regulated feedback voltage	TPS62300 TPS62320			0.4		V	
$A_{(PT)}$	DC power train amplification ( $V_O/V_{(ADJ)}$ )			1.496	1.5	1.504		
$t_{on(MIN)}$	Minimum on-time (P-channel MOSFET)				35		ns	
	Resistance into VOUT sense pin			700	1000		k $\Omega$	
	Resistance into ADJ pin		$V_{(FB)} > 0.4\text{ V}$	700	1000	1300	k $\Omega$	
$I_{(FB)}$	Feedback input bias current	TPS62300 TPS62320	$V_{(FB)} = 0.4\text{ V}$		1		nA	
$V_O$	Adjustable output voltage <sup>(1)</sup>	TPS62300 TPS62320	$2.7\text{ V} \leq V_I \leq 6\text{ V}$ , $0\text{ mA} \leq I_{O(DC)} \leq 500\text{ mA}$ PFM/PWM mode operation		-2%	+2%		
		Fixed output voltage		TPS6230x TPS62311 TPS62313 TPS6232x		-2%	+2%	
				TPS62304		-2%	+2.5%	
				TPS62305 TPS62315		-2%	+2.7%	
	Adjustable output voltage dc accuracy <sup>(1)</sup>	TPS62300 TPS62320	PWM mode operation, $V_I = 3.6\text{ V}$ , No Load	$T_A = 25^\circ\text{C}$	-0.5%	+1.3%		
				$-40^\circ\text{C} \leq T_A \leq 85^\circ\text{C}$	-0.5%	+1.3%		
		Fixed output voltage dc accuracy		TPS6230x TPS62311 TPS62313 TPS6232x	$T_A = 25^\circ\text{C}$	-0.5%	+1.3%	
					$-40^\circ\text{C} \leq T_A \leq 85^\circ\text{C}$	-0.5%	+1.3%	
				TPS62304	$T_A = 25^\circ\text{C}$	-0.5%	+1.8%	
					$-40^\circ\text{C} \leq T_A \leq 85^\circ\text{C}$	-0.5%	+1.8%	
TPS62305 TPS62315	$T_A = 25^\circ\text{C}$	-0.3%	+1.7%					
	$-40^\circ\text{C} \leq T_A \leq 85^\circ\text{C}$	-0.5%	+2%					
	DC output voltage load regulation		$I_O = 0\text{ mA}$ to $500\text{ mA}$ , $MODE/SYNC = V_I$		-0.001	-0.002	%/mA	
	DC output voltage load regulation (power train in direct drive mode)		$V_{(ADJ)}$ externally forced to $1.067\text{ V}$ , $I_O = 0\text{ mA}$ to $500\text{ mA}$ , $MODE/SYNC = V_I$		-0.0003	-0.0006	%/mA	
	DC output voltage line regulation		$V_I = V_O + 0.5\text{ V}$ (min $2.7\text{ V}$ ) to $6\text{ V}$ , $I_O = 100\text{ mA}$ , $MODE/SYNC = V_I$		0.11	0.2	%/V	
	DC output voltage line regulation (power train in direct drive mode)		$V_{(ADJ)}$ externally forced to $1.067\text{ V}$ , $V_I = V_O + 0.5\text{ V}$ (min $2.7\text{ V}$ ) to $6\text{ V}$ $I_O = 100\text{ mA}$ , $MODE/SYNC = V_I$		0.035	0.1	%/V	
	Integrator slew rate			100	150	200	$\mu\text{V}/\mu\text{s}$	
$\Delta V_O$	Power-save mode ripple voltage		$I_O = 1\text{ mA}$ , $MODE/SYNC = GND$		0.025 $V_O$		$V_{P-P}$	
	Start-up time		$I_O = 200\text{ mA}$ , Time from active EN to $V_O$		250		$\mu\text{s}$	
$I_{lkg}$	Leakage current into SW pin		$V_I > V_O$ , $0\text{ V} \leq V_{(SW)} \leq V_{IN}$ , $EN = GND$		0.1	1	$\mu\text{A}$	
	Reverse leakage current into SW pin		$V_I = \text{open}$ , $V_{(SW)} = 6\text{ V}$ , $EN = GND$		0.1	1		

(1) Output voltage specification for the adjustable version does not include tolerance of external voltage programming resistors.

## PIN ASSIGNMENTS

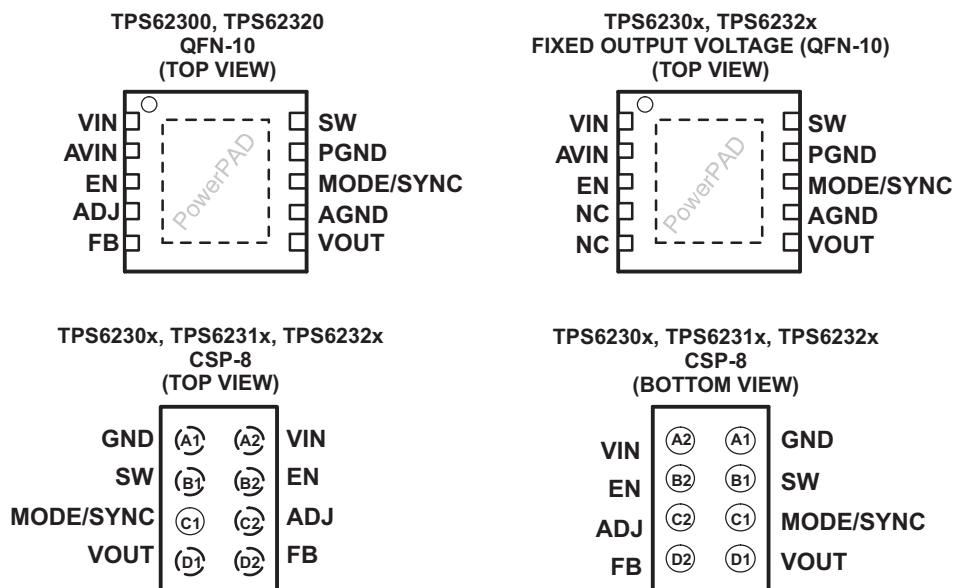

## TERMINAL FUNCTIONS

TERMINAL			I/O	DESCRIPTION
NAME	NO. QFN	NO. CSP		
VIN	1	A2	I	Supply voltage for output power stage.
AVIN	2		I	This is the input voltage pin of the device. Connect directly to the input bypass capacitor.
EN	3	B2	I	This is the enable pin of the device. Connecting this pin to ground forces the device into shutdown mode. Pulling this pin to $V_I$ enables the device. This pin must not be left floating and must be terminated.
ADJ	4	C2	I/O	This is the internal reference voltage used to regulate $V_O$ . This pin is not connected on fixed output voltage version of TPS6230xDRC and TPS6232xDRC. Do not connect ADJ pin on fixed output voltage version of TPS6230xYZD, TPS6231xYZD, TPS6231xYZ and TPS6232xYxD. On TPS62300 and TPS62320, this pin can also be used as an external control input. The output voltage is 1.5x the applied voltage at ADJ.
FB	5	D2	I	This is the feedback pin of the device. For the adjustable version, an external resistor divider is connected to this pin. The internal voltage divider is disabled for the adjustable version. This pin is not connected on fixed output voltage version of TPS6230xDRC and TPS6232xDRC. Do not connect the FB pin on the fixed output voltage version of TPS6230xYZD, TPS6231xYZD, TPS6231xYZ and TPS6232xYxD.
VOUT	6	D1	I	Output feedback sense input. Connect VOUT to the converter's output.
AGND	7			Analog ground. Connect to PGND via the PowerPAD™ underneath IC.
MODE/SYNC	8	C1	I	Input for synchronization to external clock signal. This pin must not be left floating and must be terminated. Synchronizes the converter switching frequency to an external clock signal MODE/SYNC = LOW (GND): The device is operating in fixed frequency pulse width modulation mode (PWM) at high-load currents and in pulse frequency modulation mode (PFM) at light load currents. MODE/SYNC = HIGH (VIN): Low-noise mode enabled, fixed frequency PWM operation forced.
PGND	9	A1		Power ground.
SW	10	B1	I/O	This is the switch pin of the converter and is connected to the drain of the internal Power MOSFETs.
PowerPAD™			N/A	Internally connected to PGND.

## FUNCTIONAL BLOCK DIAGRAM

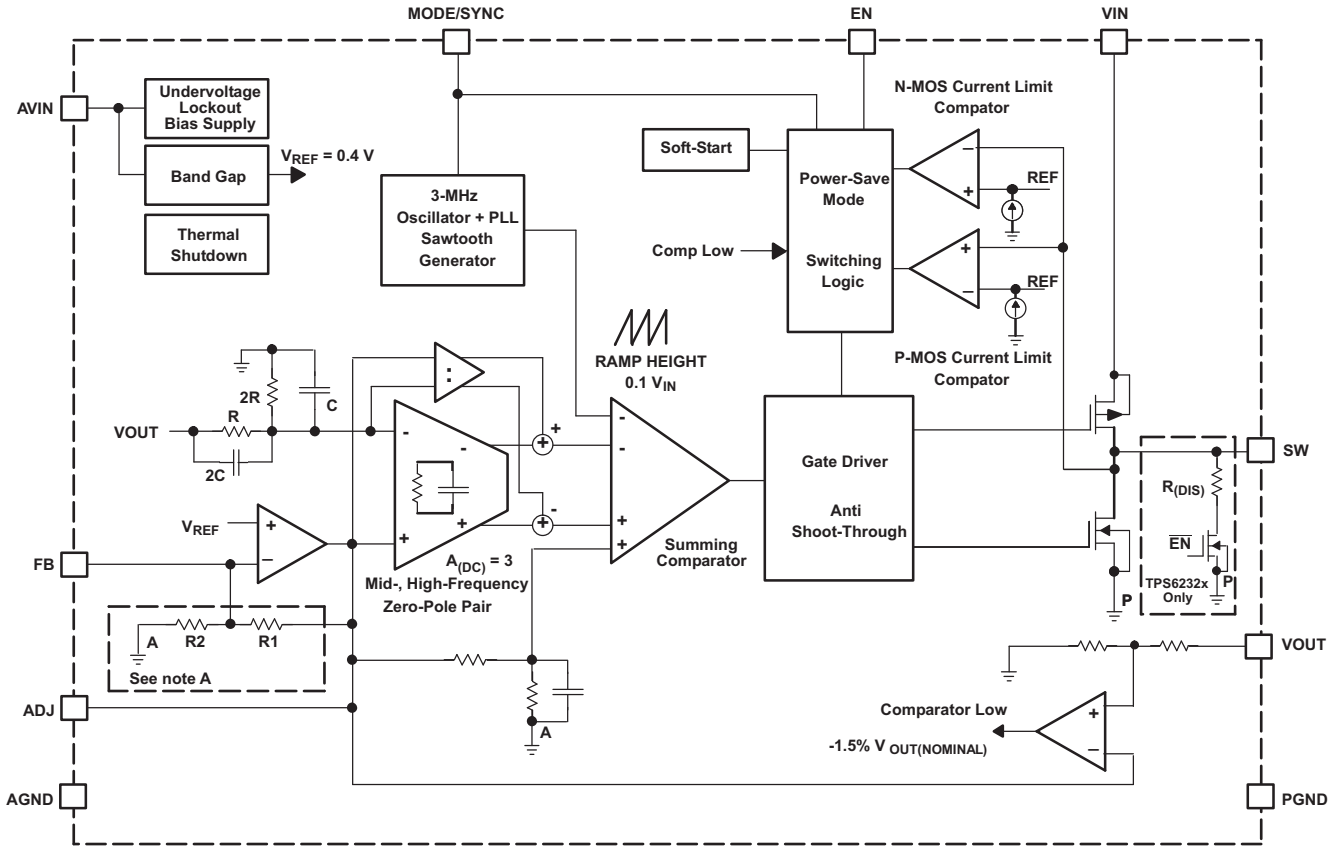

**NOTE A:** For the adjustable versions (TPS62300 and TPS62320) the internal feedback divider is disabled.

## PARAMETER MEASUREMENT INFORMATION

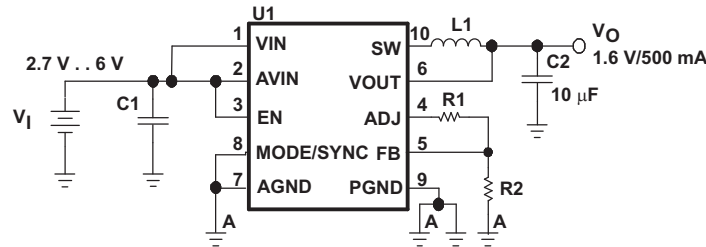

**List of Components:**  
 U1 = TPS6230x  
 L1 = FDK MIPW3226 Series  
 C1, C2 = X5R/X7R

TYPICAL CHARACTERISTICS

Table of Graphs

			FIGURE
$\eta$	Efficiency	vs Load current	3, 4, 5, 6
		vs Input voltage	7
	Line transient response		8
	Load transient response		9, 10, 11, 12, 13, 14, 15, 16
$V_O$	DC output voltage	vs Load current	17
$V_{FB}$	Regulated feedback voltage	vs Temperature	18
$I_Q$	No load quiescent current	vs Input voltage	19
$f_s$	Switching frequency	vs Temperature	20
	Duty cycle jitter		21
$r_{DS(on)}$	P-channel MOSFET $r_{DS(on)}$	vs Input voltage	22
	N-channel MOSFET $r_{DS(on)}$	vs Input voltage	23
	PWM operation		24
	Power-save mode operation		25
	Dynamic voltage management		26, 27
	Start-up		28, 29
	Power down (TPS6232x)		30

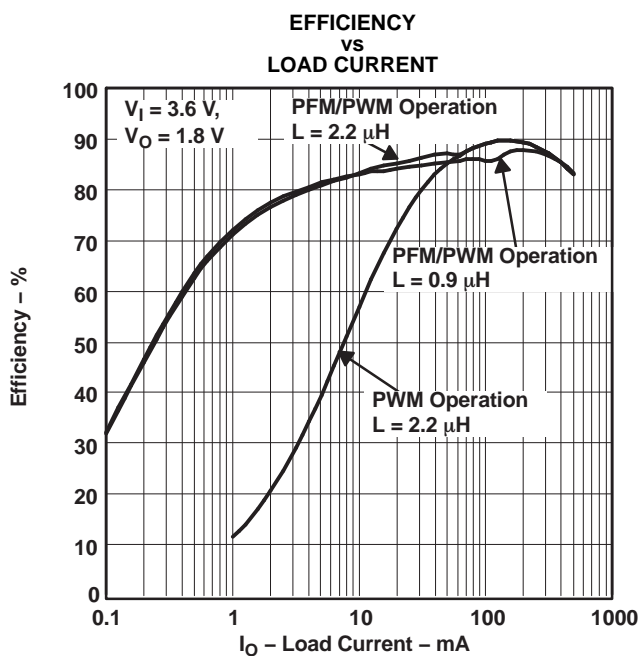

Figure 3.

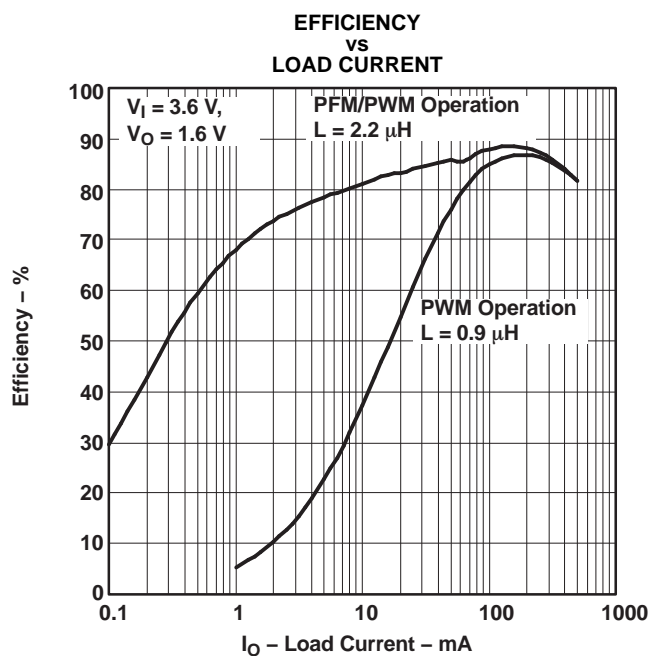

Figure 4.

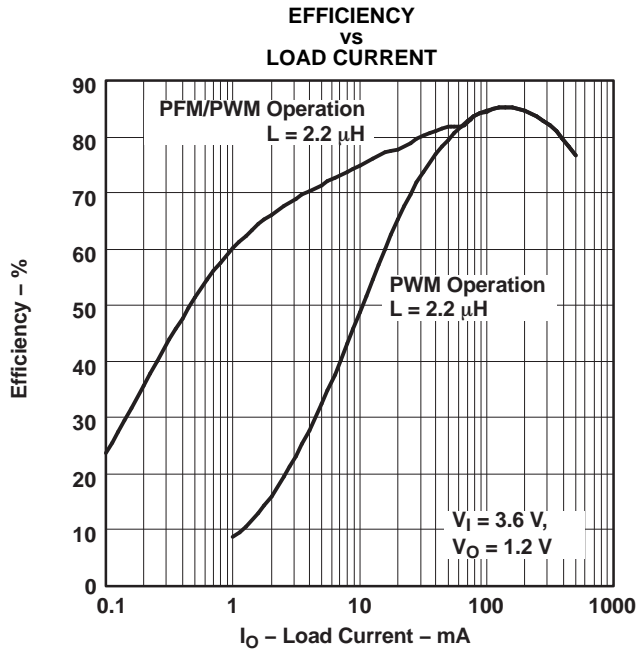

Figure 5.

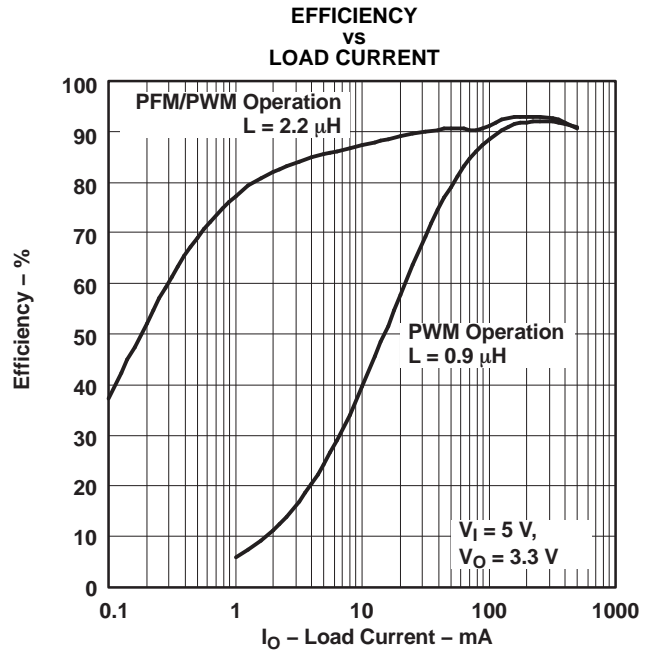

Figure 6.

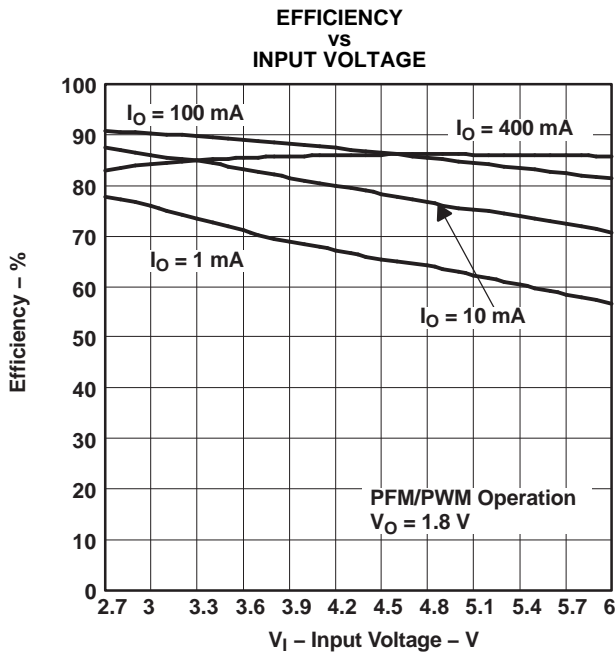

Figure 7.

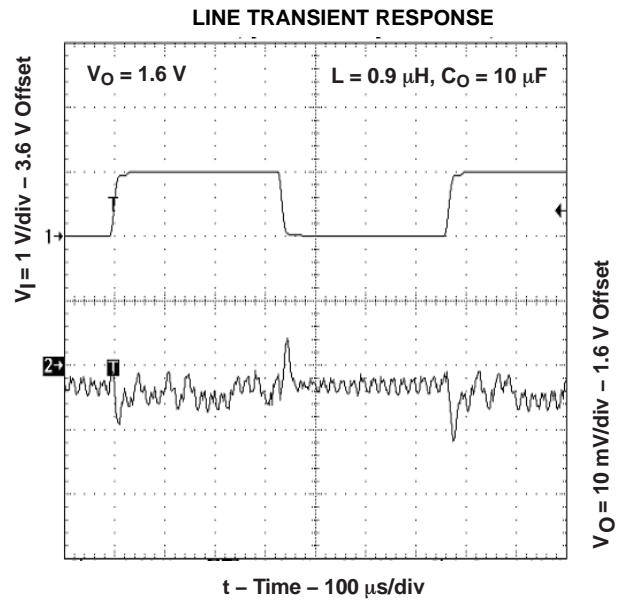

Figure 8.

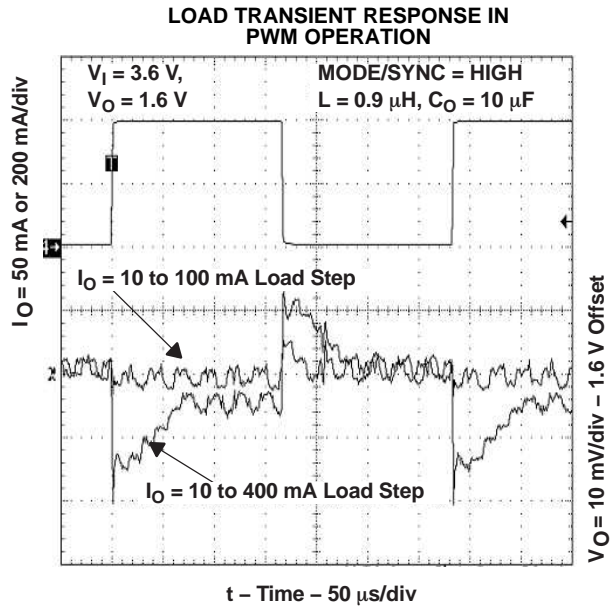

Figure 9.

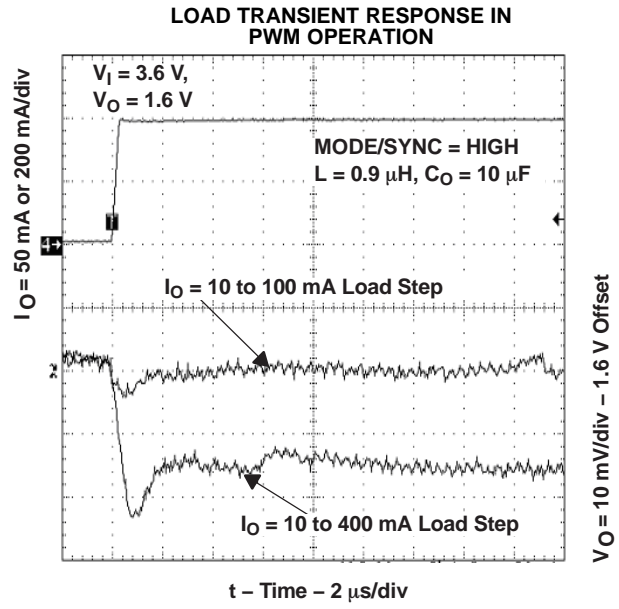

Figure 10.

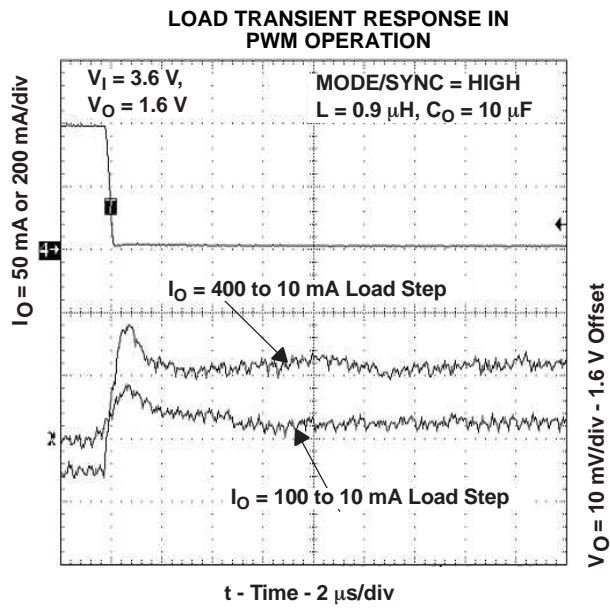

Figure 11.

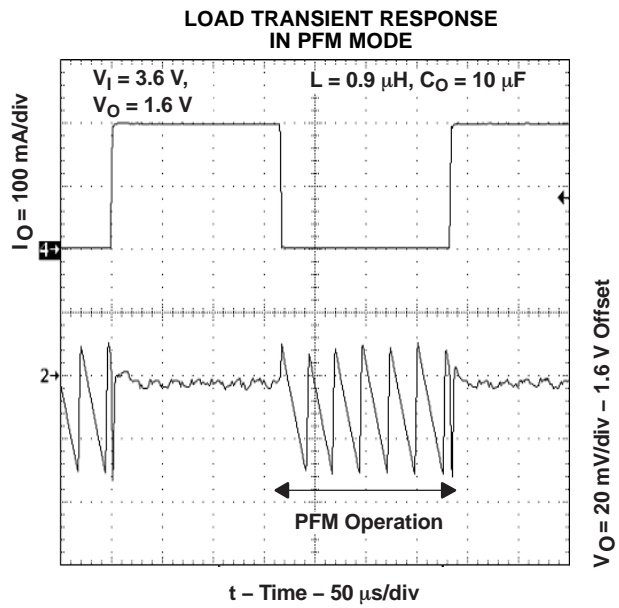

Figure 12.

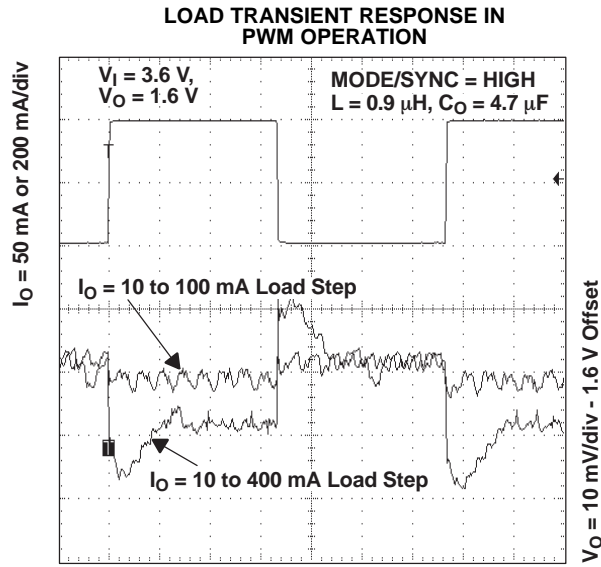

Figure 13.

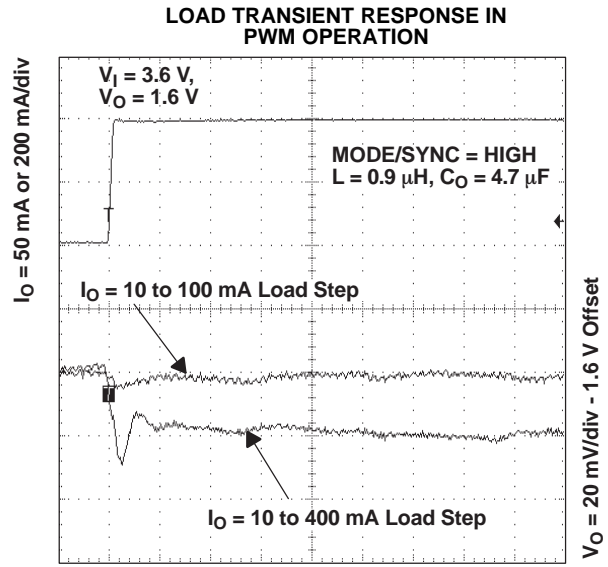

Figure 14.

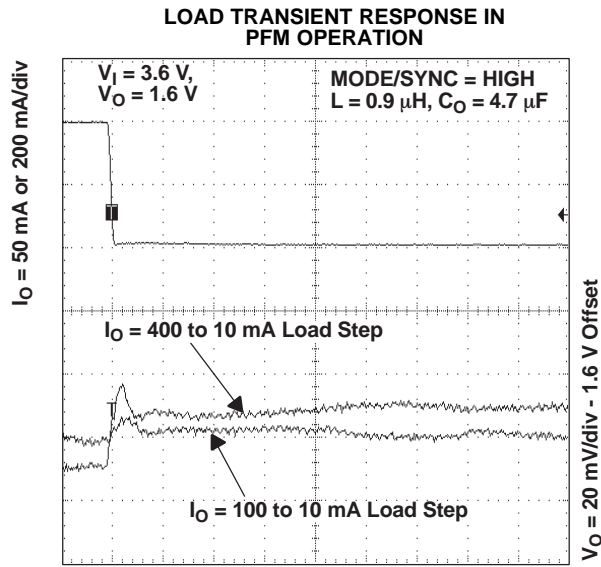

Figure 15.

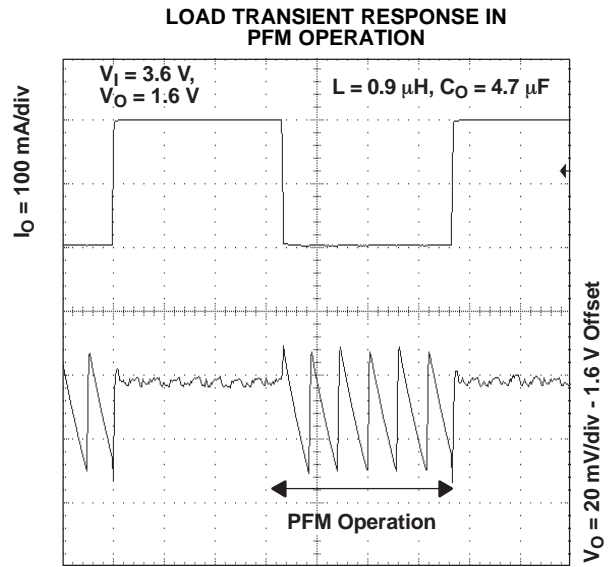

Figure 16.

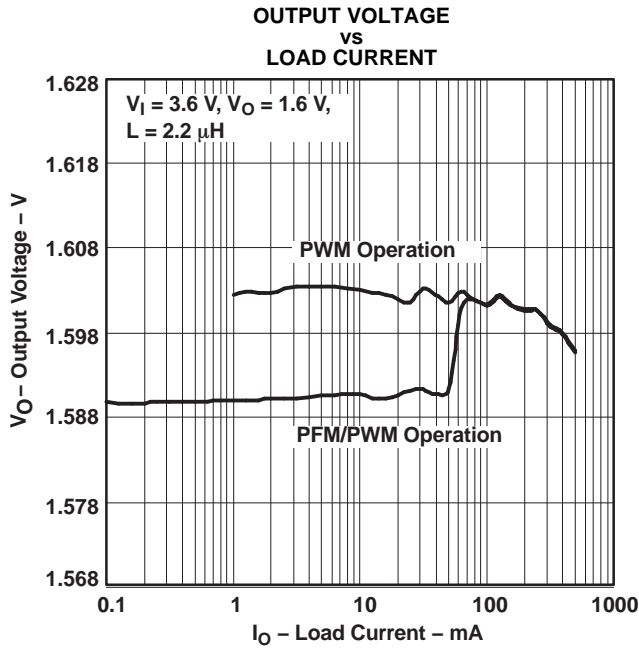

Figure 17.

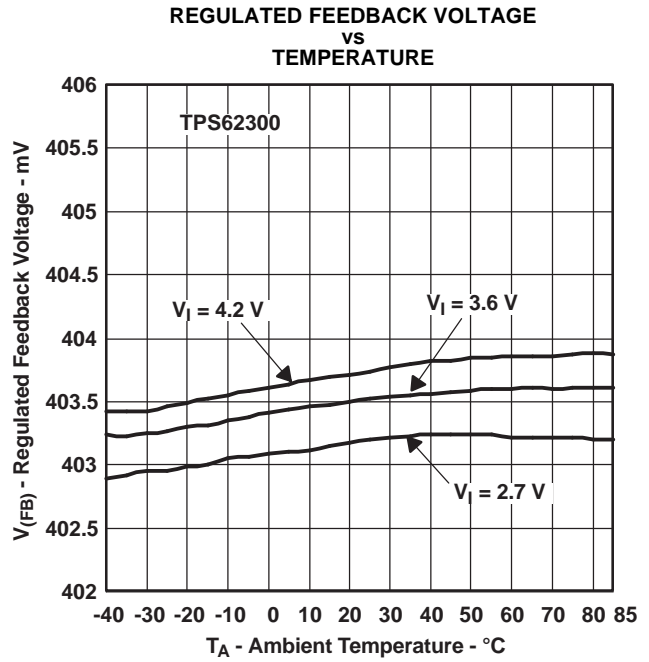

Figure 18.

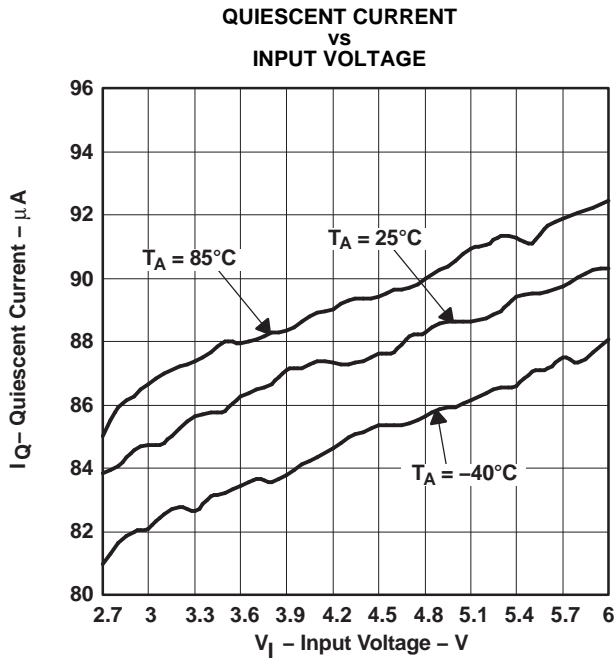

Figure 19.

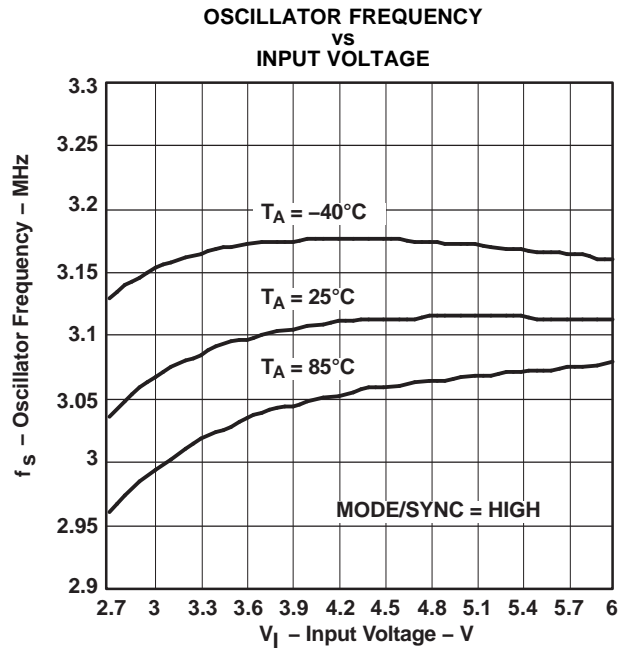

Figure 20.

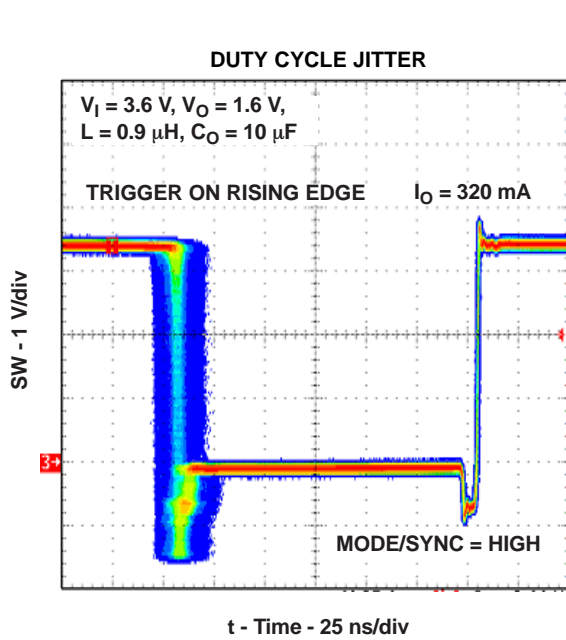

Figure 21.

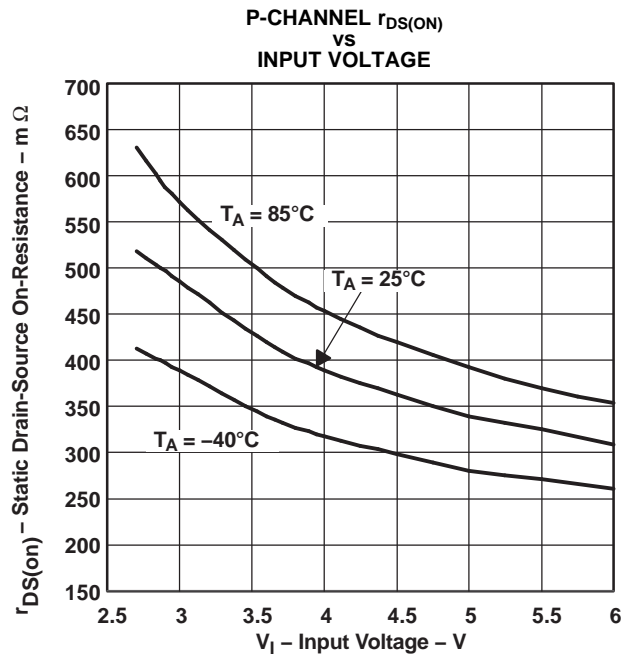

Figure 22.

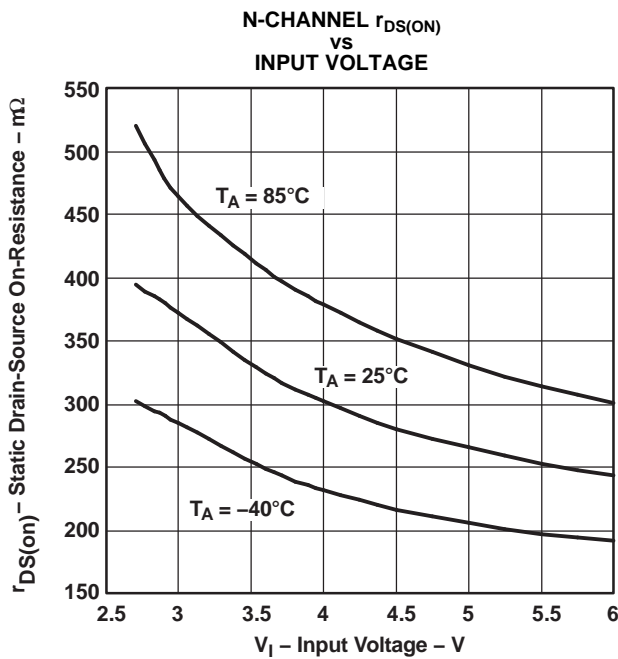

Figure 23.

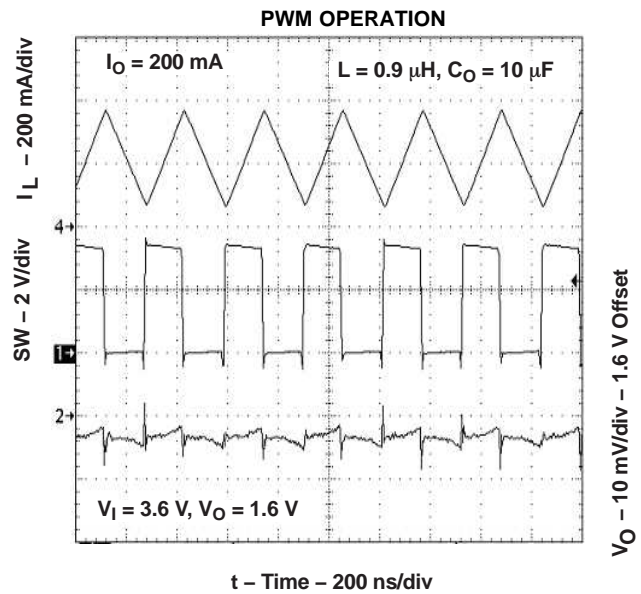
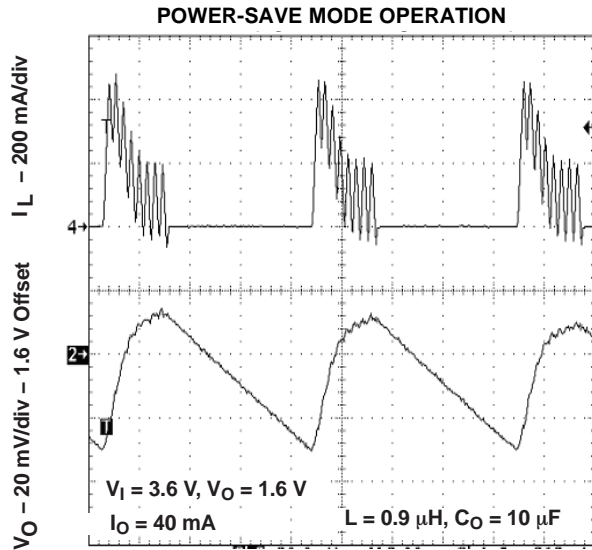
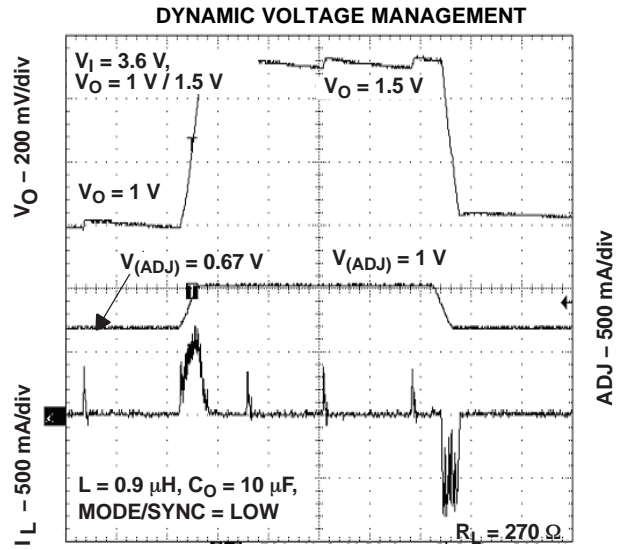

Figure 24.



t – Time – 2  $\mu\text{s}/\text{div}$

Figure 25.



t – Time – 20  $\mu\text{s}/\text{div}$

Figure 26.

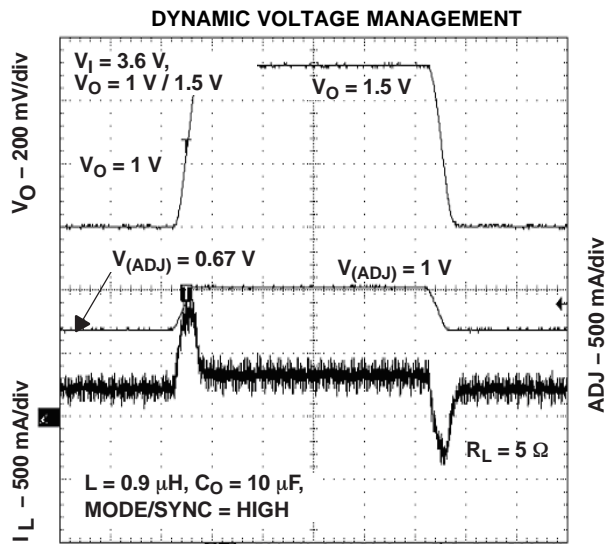

t – Time – 20  $\mu\text{s}/\text{div}$

Figure 27.

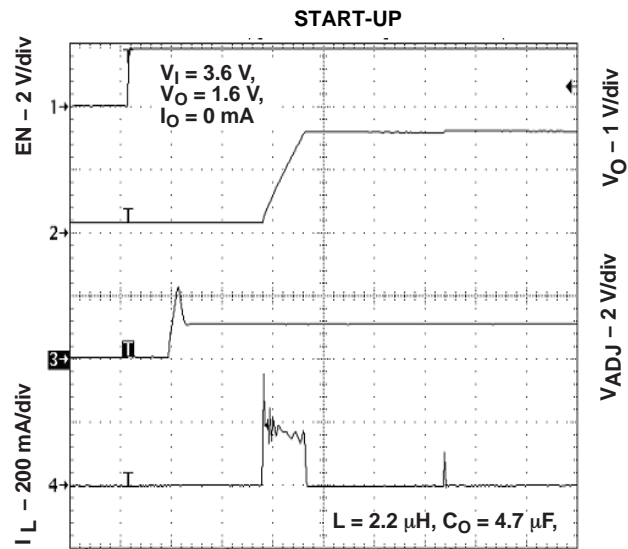

t – Time – 50  $\mu\text{s}/\text{div}$

Figure 28.

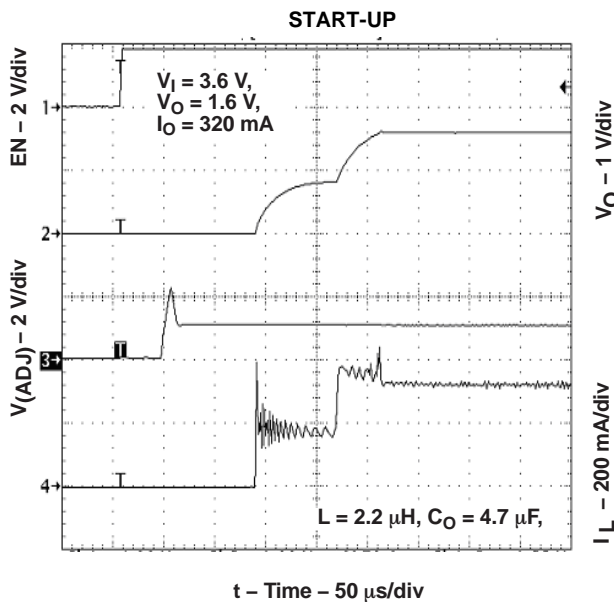

Figure 29.

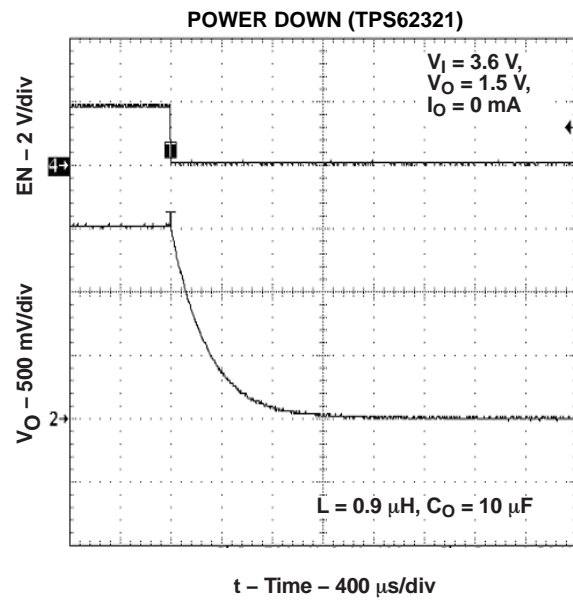

Figure 30.

## DETAILED DESCRIPTION

### OPERATION

The TPS6230x, TPS6231x, and TPS6232x are synchronous step-down converters typically operating with a 3-MHz fixed frequency pulse width modulation (PWM) at moderate to heavy load currents. At light load currents, the converter operates in power-save mode with pulse frequency modulation (PFM). The operating frequency is set to 3 MHz and can be synchronized *on-the-fly* to an external oscillator.

During PWM operation, the converter uses a unique fast response, voltage mode, controller scheme with input voltage feed-forward. This achieves *best-in-class* load and line response and allows the use of tiny inductors and small ceramic input and output capacitors. At the beginning of each switching cycle, the P-channel MOSFET switch is turned on and the inductor current ramps up until the comparator trips and the control logic turns off the switch.

The device integrates two current limits, one in the P-channel MOSFET and another one in the N-channel MOSFET. When the current in the P-channel MOSFET reaches its current limit, the P-channel MOSFET is turned off and the N-channel MOSFET is turned on. When the current in the N-channel MOSFET is above the N-MOS current limit threshold, the N-channel MOSFET remains on until the current drops below its current limit. The current limit in the N-channel MOSFET is important for small duty-cycle operation when the current in the inductor does not decrease because of the P-channel MOSFET current limit delay, or because of start-up conditions where the output voltage is low.

## POWER-SAVE MODE

With decreasing load current, the device automatically switches into pulse skipping operation in which the power stage operates intermittently based on load demand. By running cycles periodically, the switching losses are minimized, and the device runs with a minimum quiescent current and maintaining high efficiency.

In power-save mode, the converter only operates when the output voltage trips below a set threshold voltage ( $-1.5\% V_{O(NOMINAL)}$ ). It ramps up the output voltage with several pulses and goes into power-save mode once the output voltage exceeds the nominal output voltage. As a consequence, the average output voltage is slightly lower than its nominal value in the power-save mode operation.

The output current at which the PFM/PWM transition occurs is approximated by [Equation 1](#):

$$I_{PFM/PWM} = \frac{V_O}{V_I} \times \frac{V_I - V_O}{2 \times L \times f_{sw}} \quad (1)$$

- $I_{PFM/PWM}$  : output current at which PFM/PWM transition occurs
- $f_{sw}$  : switching frequency (3-MHz typical)
- $L$  : inductor value

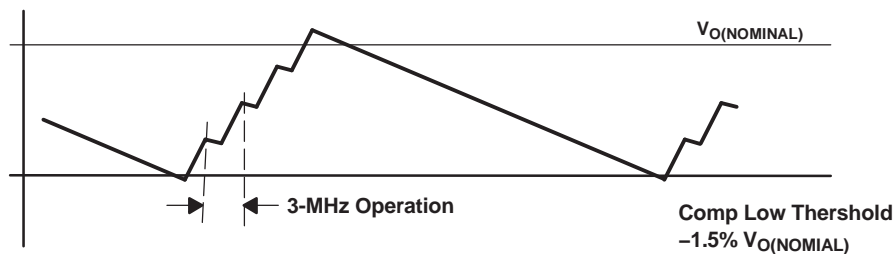

Figure 31. Power-Save Mode Threshold

## MODE SELECTION AND FREQUENCY SYNCHRONIZATION

The MODE/SYNC pin is a multipurpose pin which allows mode selection and frequency synchronization. Connecting this pin to GND enables the automatic PWM and power-save mode operation. The converter operates in fixed frequency PWM mode at moderate to heavy loads and in the PFM mode during light loads, which maintains high efficiency over a wide load current range.

Pulling the MODE/SYNC pin high forces the converter to operate in the PWM mode even at light load currents. The advantage is that the converter operates with a fixed frequency that allows simple filtering of the switching frequency for noise-sensitive applications. In this mode, the efficiency is lower compared to the power-save mode during light loads. For additional flexibility, it is possible to switch from power-save mode to forced PWM mode during operation. This allows efficient power management by adjusting the operation of the converter to the specific system requirements.

The TPS6230x, TPS6231x, and TPS6232x can also be synchronized to an external 3-MHz clock signal by the MODE/SYNC pin. During synchronization, the mode is set to fixed-frequency operation and the P-channel MOSFET turnon is synchronized to the falling edge of the external clock. This creates the ability for multiple converters to be connected together in a master-slave configuration for frequency matching of the converters (see the application section for more details, [Figure 37](#)).

## SOFT START

The TPS6230x, TPS6231x, and TPS6232x have an internal soft-start circuit that limits the inrush current during start-up. This prevents possible input voltage drops when a battery or a high-impedance power source is connected to the input of the converter. The soft start is implemented as a digital circuit increasing the switch current in steps of typically 195 mA, 390 mA, 585 mA, and the typical switch current limit of 780 mA.

The current limit transitions to the next step every 256 clocks ( $\approx 88\mu s$ ). To be able to switch from 390 mA to 585 mA current limit step, the output voltage needs to be higher than  $0.5 \times V_{O(NOM)}$ , otherwise, the parts continues to operate at the 390-mA current limit. This mechanism is used to limit the output current under short-circuit conditions. Therefore, the start-up time mainly depends on the output capacitor and load current.

## LOW-DROPOUT OPERATION 100% DUTY CYCLE

In 100% duty cycle mode, the TPS6230x, TPS6231x, and TPS6232x offer a low input-to-output voltage difference. In this mode, the P-channel MOSFET is constantly turned on. This is particularly useful in battery-powered applications to achieve the longest operation time by taking full advantage of the whole battery voltage range. The minimum input voltage to maintain regulation, depending on the load current and output voltage, can be calculated as:

- $V_{I(MIN)} = V_{O(MAX)} + I_{O(MAX)} \times (r_{DS(on) MAX} + R_L)$
- $I_{O(MAX)}$  : Maximum output current
- $r_{DS(on) MAX}$  : Maximum P-channel switch  $r_{DS(on)}$
- $R_L$  : DC resistance of the inductor
- $V_{O(MAX)}$  : nominal output voltage plus maximum output voltage tolerance

## ENABLE

The device starts operation when EN is set high and starts up with the soft start as previously described.

Pulling the EN pin low forces the device into shutdown, with a shutdown quiescent current of typically 0.1  $\mu$ A. In this mode, the P and N-channel MOSFETs are turned off, the internal resistor feedback divider is disconnected, and the entire internal-control circuitry is switched off. When an output voltage is present during shutdown mode, which can be caused by an external voltage source or super capacitor, the reverse leakage is specified under electrical characteristics. For proper operation, the EN pin must be terminated and must not be left floating.

In addition, the TPS6232x devices integrate a resistor, typically 35  $\Omega$ , to actively discharge the output capacitor when the device turns off. The required time to discharge the output capacitor at  $V_O$  depends on load current.

## UNDERVOLTAGE LOCKOUT

The undervoltage lockout circuit prevents the device from misoperation at low input voltages. It prevents the converter from turning on the switch or rectifier MOSFET under undefined conditions.

The TPS6231x devices have a UVLO threshold set to 2 V (typical). Fully functional operation is permitted down to 2.4 V input voltage. EN is set low for input voltages lower than 2.4 V to avoid the possibility of misoperation.

TPS6231x devices are to be considered where the user requires direct control of the turn-off sequence as part of a larger power management system.

## SHORT-CIRCUIT PROTECTION

As soon as the output voltage falls below 50% of the nominal output voltage, the converter current limit is reduced by 50% of the nominal value. Because the short-circuit protection is enabled during start-up, the device does not deliver more than half of its nominal current limit until the output voltage exceeds 50% of the nominal output voltage. This needs to be considered when a load acting as a current sink is connected to the output of the converter.

## THERMAL SHUTDOWN

As soon as the junction temperature,  $T_J$ , exceeds typically 150°C, the device goes into thermal shutdown. In this mode, the P- and N-channel MOSFETs are turned off. The device continues its operation when the junction temperature falls below typically 130°C again.

## APPLICATION INFORMATION

### ADJUSTABLE OUTPUT VOLTAGE

When the adjustable output voltage versions, TPS62300 or TPS62320, are used, the output voltage is set by the external resistor divider (see Figure 32).

The output voltage is calculated as:

$$V_O = 1.5 \times V_{ref} \times \left(1 + \frac{R1}{R2}\right) \text{ with an internal reference voltage } V_{ref} \text{ typical} = 0.4 \text{ V} \quad (2)$$

To keep the operating quiescent current to a minimum, it is recommended that R2 be set in the range of 75 kΩ to 130 kΩ. Route the FB line away from noise sources, such as the inductor or the SW line.

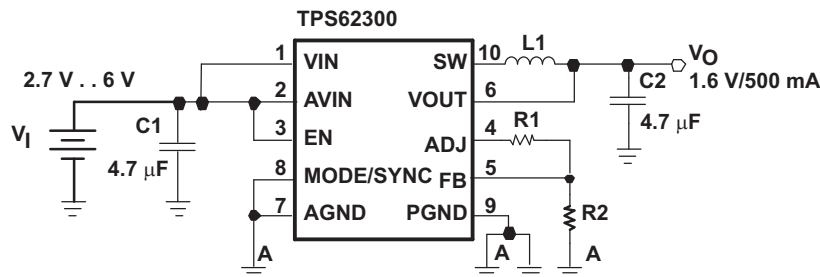

Figure 32. Adjustable Output Voltage Version

### OUTPUT FILTER DESIGN (INDUCTOR AND OUTPUT CAPACITOR)

The TPS6230x, TPS6231x, and TPS6232x series of step-down converters have internal loop compensation. Therefore, the external L-C filter must be selected to work with the internal compensation.

The device has been designed to operate with inductance values between a minimum of 0.7 µH and maximum of 6.2 µH. The internal compensation is optimized to operate with an output filter of L = 1 µH and C<sub>O</sub> = 10 µF. Such an output filter has its corner frequency at:

$$f_c = \frac{1}{2\pi \sqrt{L \times C_O}} = \frac{1}{2\pi \sqrt{1 \mu\text{H} \times 10 \mu\text{F}}} = 50.3 \text{ kHz} \quad (3)$$

Operation with a higher corner frequency (e.g., L = 1 µH, C<sub>O</sub> = 4.7 µF) is possible. However, it is recommended the loop stability be checked in detail. Selecting a larger output capacitor value (e.g., 22 µF) is less critical because the corner frequency moves to lower frequencies with fewer stability problems. The possible output filter combinations are listed in Table 1.

Regardless of the inductance value, operation is recommended with 10-µF output capacitor in applications with high-load transients (e.g., ≥ 1600 mA/µs).

Table 1. Output Filter Combinations

INDUCTANCE (L)	OUTPUT CAPACITANCE (C <sub>O</sub> )
1 µH	≥ 4.7 µF (ceramic capacitor)
2.2 µH	≥ 2.2 µF (ceramic capacitor)

The inductor value also has an impact on the pulse skipping operation. The transition into power-save mode begins when the valley inductor current goes below a level set internally. Lower inductor values result in higher ripple current which occurs at lower load currents. This results in a dip in efficiency at light load operations.

## INDUCTOR SELECTION

Even though the inductor does not influence the operating frequency, the inductor value has a direct effect on the ripple current. The selected inductor has to be rated for its dc resistance and saturation current. The inductor ripple current ( $\Delta I_L$ ) decreases with higher inductance and increases with higher  $V_I$  or  $V_O$ .

$$\Delta I_L = \frac{V_O}{V_I} \times \frac{V_I - V_O}{L \times f_{sw}} \quad \Delta I_{L(MAX)} = I_{O(MAX)} + \frac{\Delta I_L}{2} \quad (4)$$

with:  $f_{sw}$  = switching frequency (3 MHz typical)

L = inductor value

$\Delta I_L$  = peak-to-peak inductor ripple current

$I_{L(MAX)}$  = maximum inductor current

Normally, it is advisable to operate with a ripple of less than 30% of the average output current. Accepting larger values of ripple current allows the use of low inductances, but results in higher output voltage ripple, greater core losses, and lower output current capability.

The total losses of the coil consist of both the losses in the DC resistance ( $R_{(DC)}$ ) and the following frequency-dependent components:

- The losses in the core material (magnetic hysteresis loss, especially at high switching frequencies)
- Additional losses in the conductor from the skin effect (current displacement at high frequencies)
- Magnetic field losses of the neighboring windings (proximity effect)
- Radiation losses

The following inductor series from different suppliers have been used with the TPS6230x, TPS6231x, and TPS6232x converters.

**Table 2. List of Inductors**

MANUFACTURER	SERIES	DIMENSIONS
FDK	MIPW3226	3.2 x 2.6 x 1 = 8.32 mm <sup>3</sup>
	MIPSA2520	2.5 x 2.0 x 1.2 = 6 mm <sup>3</sup>
Murata	LQM2HP	2.5 x 2.0 x 1.2 = 6 mm <sup>3</sup>
Taiyo Yuden	LQ CB2016	2 x 1.6 x 1.6 = 5.12 mm <sup>3</sup>
	LQ CB2012	2 x 1.2 x 1.2 = 2.88 mm <sup>3</sup>
	LQ CBL2012	2 x 1.2 x 1 = 2.40 mm <sup>3</sup>
TDK	VLF3010AT	2.8 x 2.6 x 1 = 7.28 mm <sup>3</sup>
Coilcraft	LPS3010	3.3 x 3.3 x 1 = 10.89 mm <sup>3</sup>
JFE	32R1560	3.2 x 2.5 x 0.6 = 4.8 mm <sup>3</sup>

## OUTPUT CAPACITOR SELECTION

The advanced fast-response voltage mode control scheme of the TPS6230x, TPS6231x, and TPS6232x allows the use of tiny ceramic capacitors. Ceramic capacitors with low ESR values have the lowest output voltage ripple and are recommended. The output capacitor requires either an X7R or X5R dielectric. Y5V and Z5U dielectric capacitors, aside from their wide variation in capacitance over temperature, become resistive at high frequencies.

At nominal load current, the device operates in PWM mode and the overall output voltage ripple is the sum of the voltage spike caused by the output capacitor ESR plus the voltage ripple caused by charging and discharging the output capacitor:

$$\Delta V_O = \frac{V_O}{V_I} \times \frac{V_I - V_O}{L \times f_{sw}} \times \left( \frac{1}{8 \times C_O \times f_{sw}} + \text{ESR} \right), \text{ maximum for high } V_I \quad (5)$$

At light loads, the device operates in power-save mode and the output voltage ripple is independent of the output capacitor value. The output voltage ripple is set by the internal comparator thresholds and propagation delays. The typical output voltage ripple is 1.5% of the nominal output voltage  $V_O$ .

## INPUT CAPACITOR SELECTION

Because of the nature of the buck converter having a pulsating input current, a low ESR input capacitor is required to prevent large voltage transients that can cause misbehavior of the device or interferences with other circuits in the system. For most applications, a 2.2- $\mu\text{F}$  or 4.7- $\mu\text{F}$  capacitor is sufficient.

Take care when using only ceramic input capacitors. When a ceramic capacitor is used at the input and the power is being supplied through long wires, such as from a wall adapter, a load step at the output can induce ringing at the VIN pin. This ringing can couple to the output and be mistaken as loop instability or could even damage the part.

## CHECKING LOOP STABILITY

The first step of circuit and stability evaluation is to look from a steady-state perspective at the following signals:

- Switching node, SW
- Inductor current,  $I_L$
- Output ripple voltage,  $V_{O(AC)}$

These are the basic signals that need to be measured when evaluating a switching converter. When the switching waveform shows large duty cycle jitter or the output voltage or inductor current shows oscillations, the regulation loop may be unstable. This is often a result of board layout and/or L-C combination.

As a next step in the evaluation of the regulation loop, the load transient response is tested. The time between the application of the load transient and the turn on of the P-channel MOSFET, the output capacitor must supply all of the current required by the load.  $V_O$  immediately shifts by an amount equal to  $\Delta I_{(LOAD)} \times \text{ESR}$ , where ESR is the effective series resistance of  $C_O$ .  $\Delta I_{(LOAD)}$  begins to charge or discharge  $C_O$  generating a feedback error signal used by the regulator to return  $V_O$  to its steady-state value.

During this recovery time,  $V_O$  can be monitored for settling time, overshoot or ringing that helps judge the converter's stability. Without any ringing, the loop has usually more than 45° of phase margin.

Because the damping factor of the circuitry is directly related to several resistive parameters (e.g., MOSFET  $r_{DS(on)}$ ) that are temperature dependant, the loop stability analysis has to be done over the input voltage range, load current range, and temperature range.

## PROGRAMMING THE OUTPUT VOLTAGE WITH A DAC

On TPS62300 and TPS62320 devices, the output voltage can be dynamically programmed to any voltage between 0.6 V and  $V_I$  (or 5.4 V whichever is lower) with an external DAC driving the ADJ and FB pins (see Figure 33). The output voltage is then equal to  $A_{(PT)} \times V_{(DAC)}$  with a *Power Train* amplification  $A_{(PT)}$  typical = 1.5.

When the output voltage is driven low, the converter reduces its output quickly in forced PWM mode, boosting the output energy back to the input. If the input is not connected to a low-impedance source capable of absorbing the energy, the input voltage can rise above the absolute maximum voltage of the part and get damaged. The faster  $V_O$  is commanded low, the higher is the voltage spike at the input.

For best results, ramp the ADJ/FB signal as slow as the application allows. To avoid over-slew of the regulation loop of the converter, avoid abrupt changes in output voltage of > 300 mV/ $\mu\text{s}$  (depending on  $V_I$ , output voltage step size and L/C combination). If ramp control is unavailable, an RC filter can be inserted between the DAC output and ADJ/FB pins to slow down the control signal.

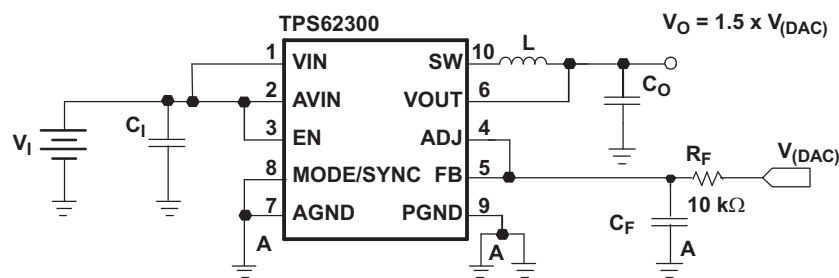

Figure 33. Filtering the DAC Voltage

## LAYOUT CONSIDERATIONS

As for all switching power supplies, the layout is an important step in the design. High-speed operation of the TPS6230x, TPS6231x, and TPS6232x devices demand careful attention to PCB layout. Care must be taken in board layout to get the specified performance. If the layout is not carefully done, the regulator could show poor line and/or load regulation, stability issues as well as EMI problems. It is critical to provide a low inductance, impedance ground path. Therefore, use wide and short traces for the main current paths as indicated in bold on Figure 34.

The input capacitor should be placed as close as possible to the IC pins as well as the inductor and output capacitor. Use a common ground node for power ground and a different one for control ground (AGND) to minimize the effects of ground noise. Connect these ground nodes together (star point) underneath the IC and make sure that small signal components returning to the AGND pin do not share the high current path of C1 and C2.

The output voltage sense line (VOUT) should be connected right to the output capacitor and routed away from noisy components and traces (e.g., SW line). Its trace should be minimized and shielded by a guard-ring connected to the reference ground. The voltage setting resistive divider should be placed as close as possible to the AGND pin of the IC.

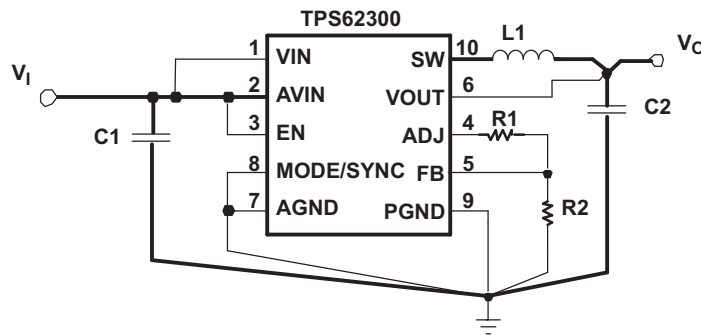

Figure 34. Layout Diagram

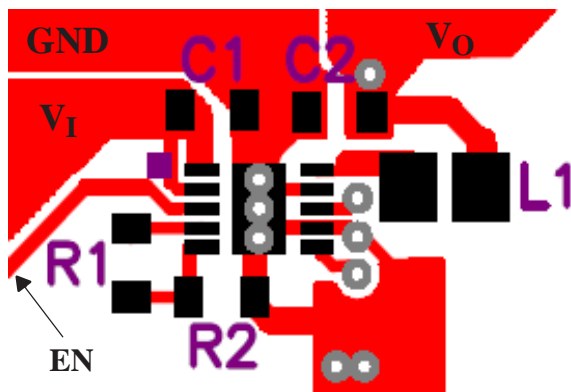

Figure 35. Suggested QFN Layout (Top)

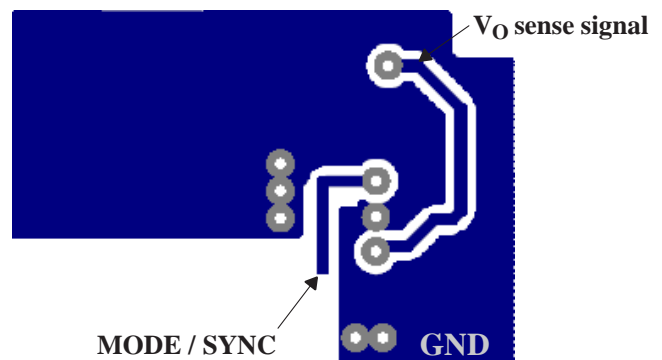

Figure 36. Suggested QFN Layout (Bottom)

## THERMAL INFORMATION

Implementation of integrated circuits in low-profile and fine-pitch surface-mount packages typically requires special attention to power dissipation. Many system-dependant issues such as thermal coupling, airflow, added heat sinks, and convection surfaces, and the presence of other heat-generating components, affect the power-dissipation limits of a given component

Three basic approaches for enhancing thermal performance are listed below:

- Improving the power dissipation capability of the PCB design
- Improving the thermal coupling of the component to the PCB
- Introducing airflow in the system

The maximum recommended junction temperature ( $T_J$ ) of the TPS6230x, TPS6231x, and TPS6232x devices is 125°C. The thermal resistance of the 8-pin CSP package (YZD, YZ and YED) is  $R_{\theta JA} = 250^\circ\text{C/W}$ . Specified regulator operation is specified to a maximum ambient temperature  $T_A$  of 85°C. Therefore, the maximum power dissipation is about 160 mW. More power can be dissipated if the maximum ambient temperature of the application is lower, or if the PowerPAD™ package (DRC) is used.

$$P_{D(\text{MAX})} = \frac{T_{J(\text{MAX})} - T_A}{R_{\theta JA}} = \frac{125^\circ\text{C} - 85^\circ\text{C}}{250^\circ\text{C/W}} = 160 \text{ mW} \quad (6)$$

## CHIP SCALE PACKAGE DIMENSIONS

The TPS6230x, TPS6231x, and TPS6232x are also available in an 8-bump chip scale package (YZD, YZ NanoFree™ and YED, NanoStar™). The package dimensions are given as:

- D = 1.970 ±0.05 mm
- E = 0.970 ±0.05 mm

## APPLICATION EXAMPLES

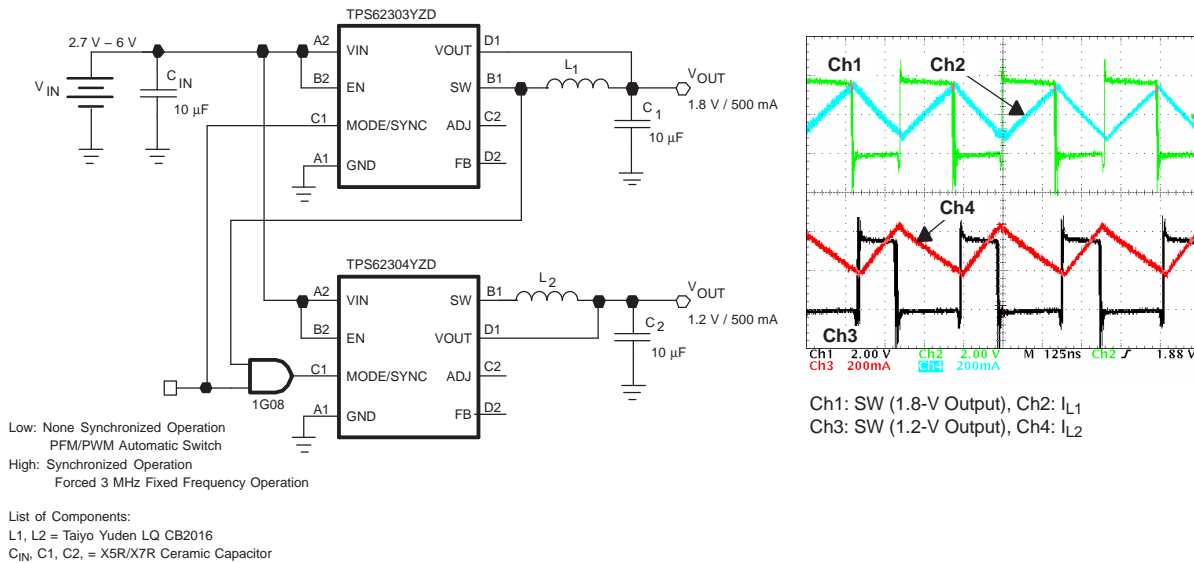

**Figure 37. Dual, Out-of-Phase, 3-MHz, 500-mA Step-Down Regulator Features Less Than 50-mm<sup>2</sup> Total Solution Size**

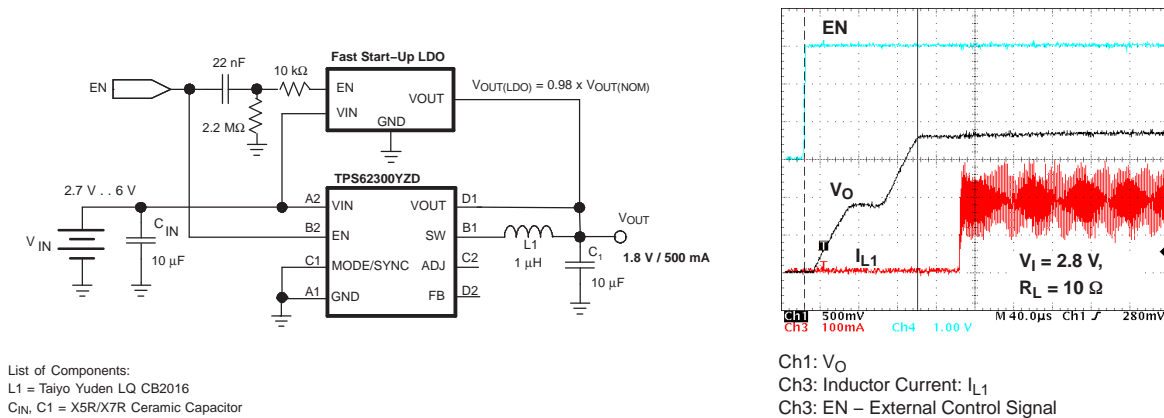

**Figure 38. Speed-Up Circuitry for Fast Turnon Time**

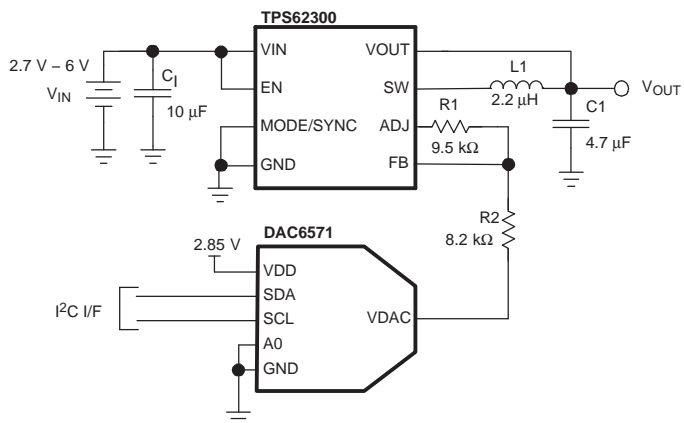

List of Components:  
 L1 = Wuerth Elektronik WE-TPC XS  
 C<sub>1</sub>, C<sub>1</sub> = X5R/X7R Ceramic Capacitor

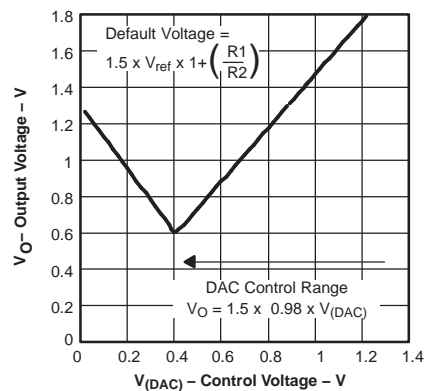

Figure 39. Dynamic Voltage Management Using I<sup>2</sup>C I/F



THERMAL INFORMATION

This package incorporates an exposed thermal pad that is designed to be attached directly to an external heatsink. The thermal pad must be soldered directly to the printed circuit board (PCB). After soldering, the PCB can be used as a heatsink. In addition, through the use of thermal vias, the thermal pad can be attached directly to a ground or power plane (whichever is applicable), or alternatively, a special heatsink structure designed into the PCB. This design optimizes the heat transfer from the integrated circuit (IC).

For information on the Quad Flatpack No-Lead (QFN) package and its advantages, refer to Application Report, Quad Flatpack No-Lead Logic Packages, Texas Instruments Literature No. SCBA017. This document is available at [www.ti.com](http://www.ti.com).

The exposed thermal pad dimensions for this package are shown in the following illustration.

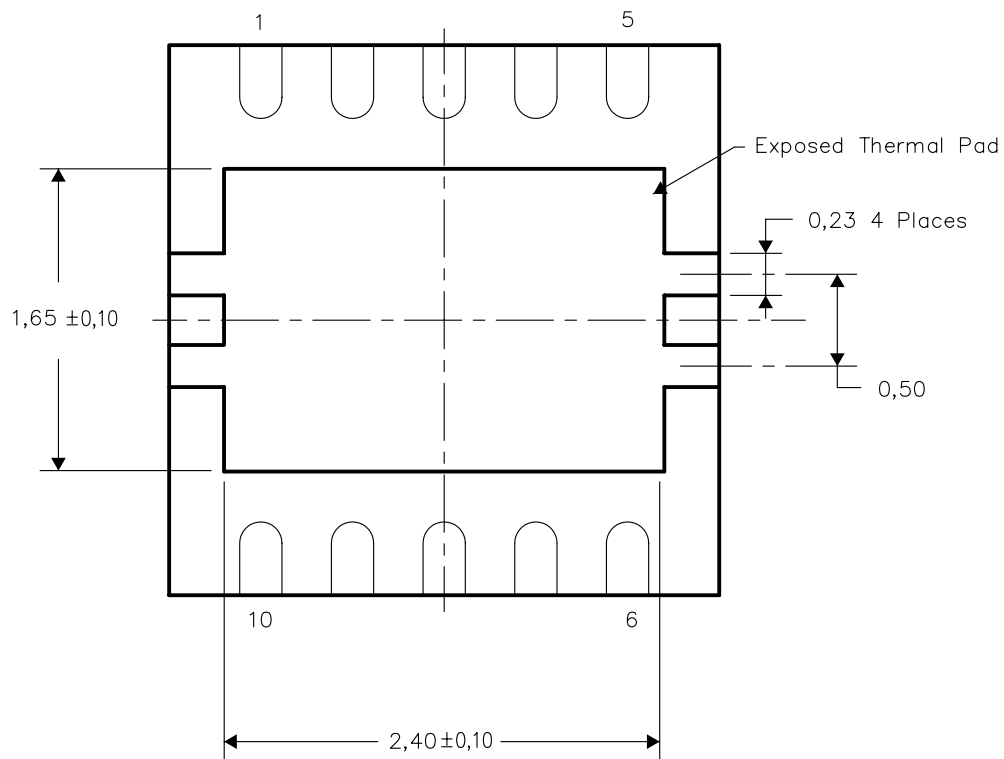

Bottom View

NOTE: All linear dimensions are in millimeters

Exposed Thermal Pad Dimensions

DRC (S-PDSO-N10)

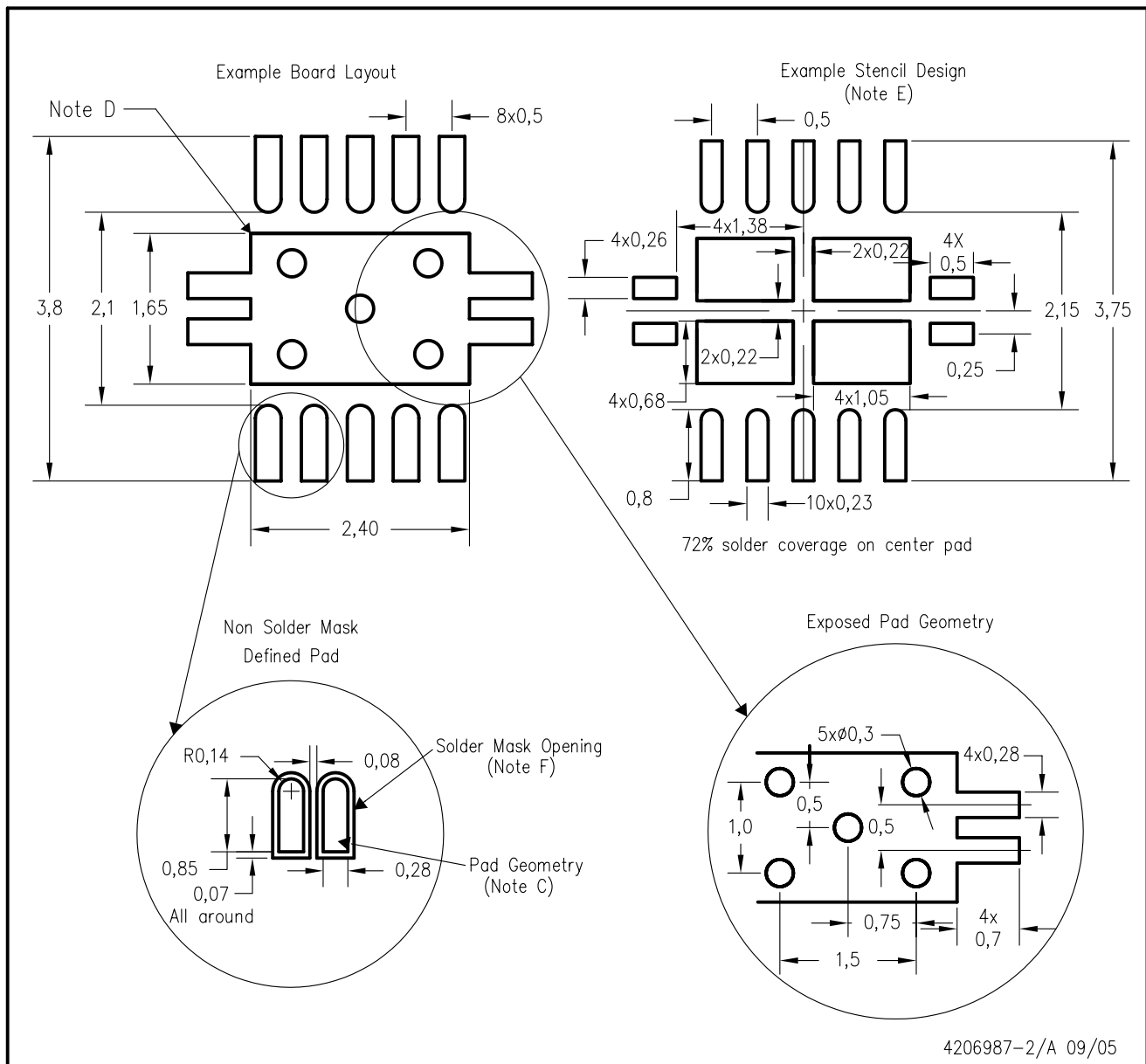

- NOTES:
- A. All linear dimensions are in millimeters.
  - B. This drawing is subject to change without notice.
  - C. Publication IPC-7351 is recommended for alternate designs.
  - D. This package is designed to be soldered to a thermal pad on the board. Refer to Application Note, Quad Flat-Pack Packages, Texas Instruments Literature No. SCBA017, SLUA271, and also the Product Data Sheets for specific thermal information, via requirements, and recommended board layout. These documents are available at [www.ti.com](http://www.ti.com) <<http://www.ti.com>>.
  - E. Laser cutting apertures with trapezoidal walls and also rounding corners will offer better paste release. Customers should contact their board assembly site for stencil design recommendations. Refer to IPC 7525 for stencil design considerations.
  - F. Customers should contact their board fabrication site for minimum solder mask web tolerances between signal pads.

YED (R-XBGA-N8)

DIE-SIZE BALL GRID ARRAY

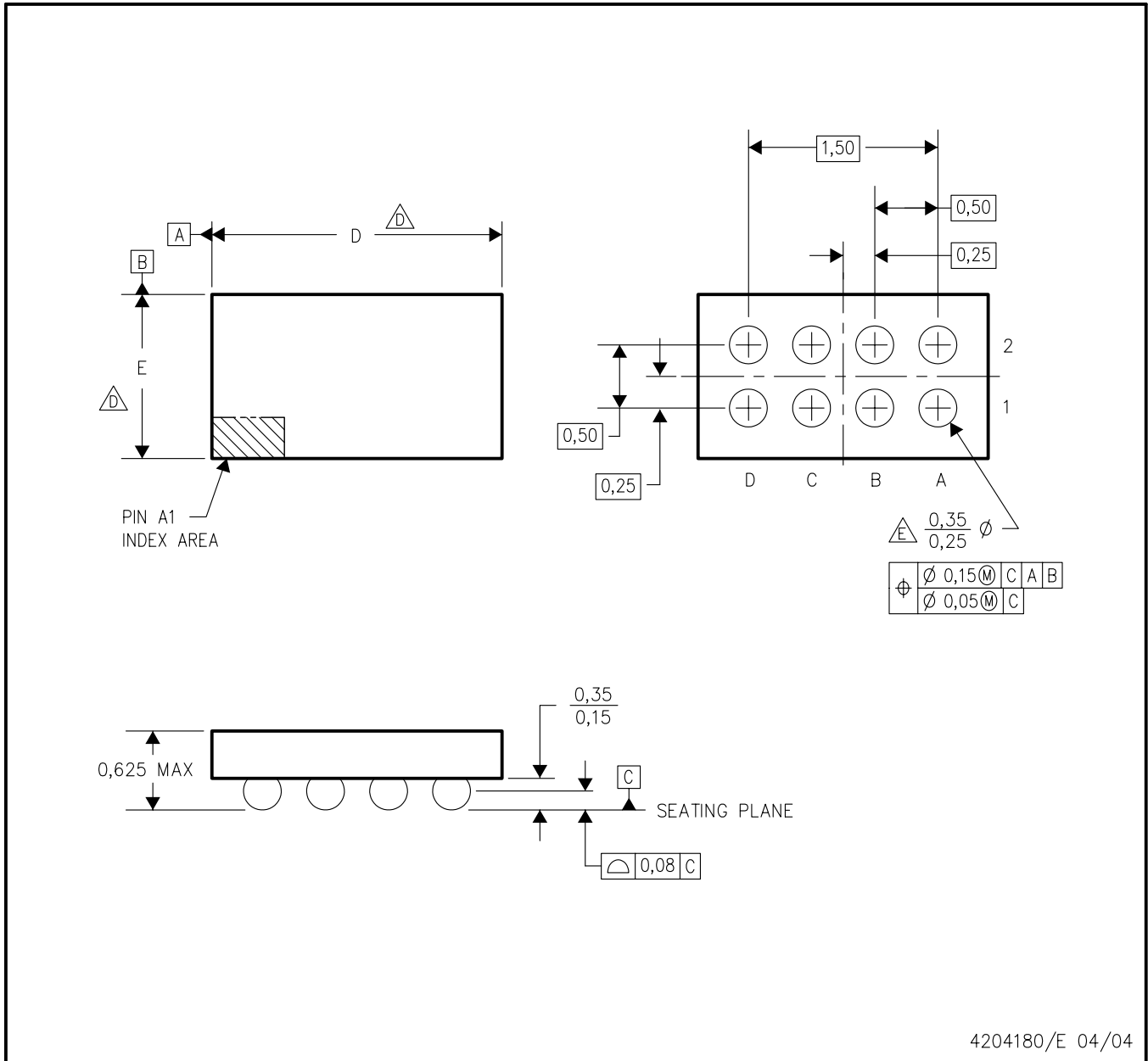

- NOTES:
- A. All linear dimensions are in millimeters.
  - B. This drawing is subject to change without notice.
  - C. NanoStar™ package configuration.
  - $\triangle D$  Devices in YED package can have dimension D ranging from 1.85 to 2.65 mm and dimension E ranging from 0.85 to 1.65 mm. To determine the exact package size of a particular device, refer to the device datasheet or contact a local TI representative.
  - $\triangle E$  Reference Product Data Sheet for array population. 4 x 2 matrix pattern is shown for illustration only.
  - F. This package contains tin-lead (SnPb) balls. Refer to YZD (Drawing #4205057) for lead-free balls.

NanoStar is a trademark of Texas Instruments.

YZD (R-XBGA-N8)

DIE-SIZE BALL GRID ARRAY

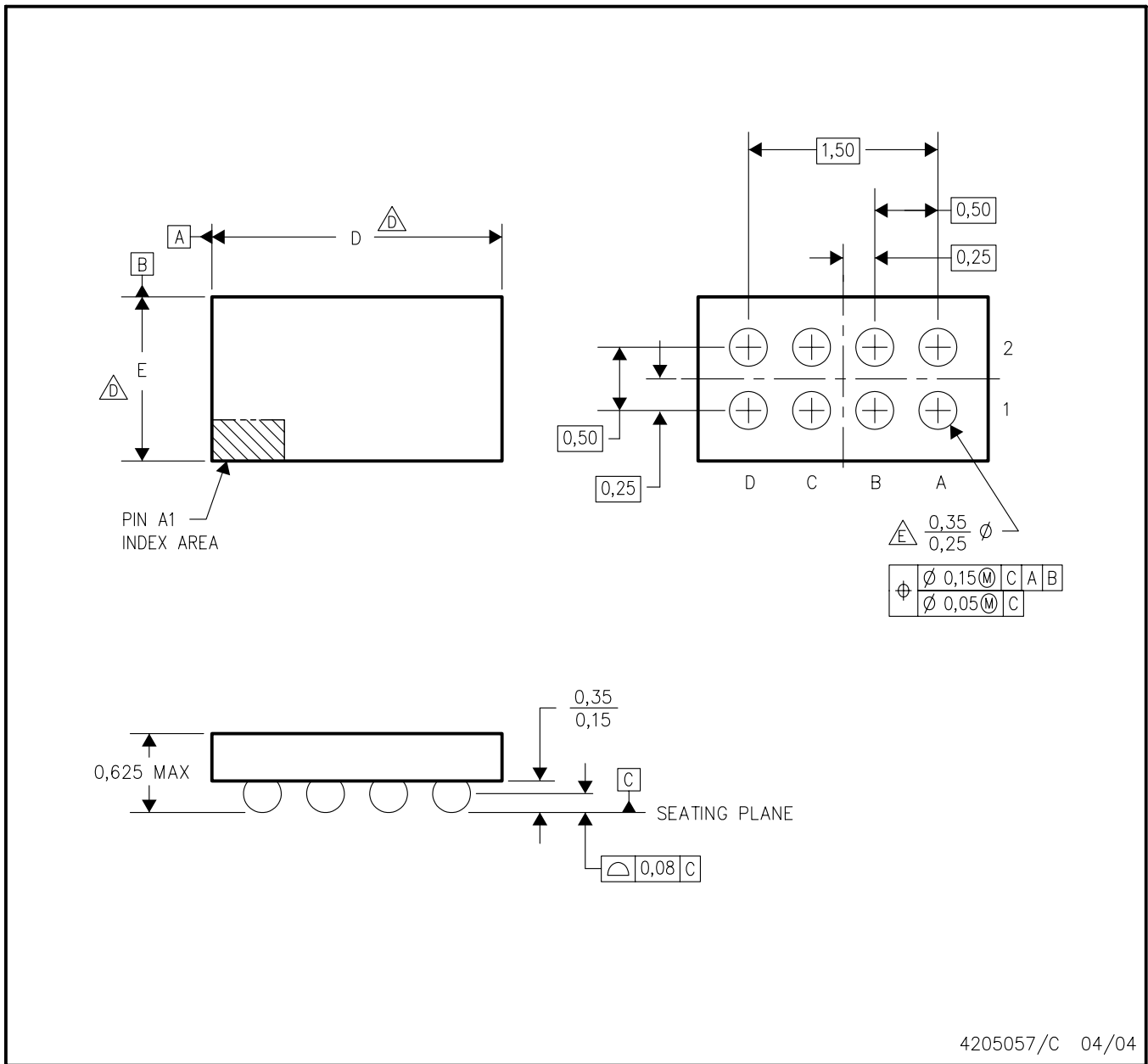

4205057/C 04/04

- NOTES:
- A. All linear dimensions are in millimeters.
  - B. This drawing is subject to change without notice.
  - C. NanoFree™ package configuration.
  - $\triangle D$  Devices in YZD package can have dimension D ranging from 1.85 to 2.65 mm and dimension E ranging from 0.85 to 1.65 mm. To determine the exact package size of a particular device, refer to the device datasheet or contact a local TI representative.
  - $\triangle E$  Reference Product Data Sheet for array population. 4 x 2 matrix pattern is shown for illustration only.
  - F. This package contains lead-free balls. Refer to YED (Drawing #4204180) for tin-lead (SnPb) balls.

NanoFree is a trademark of Texas Instruments.

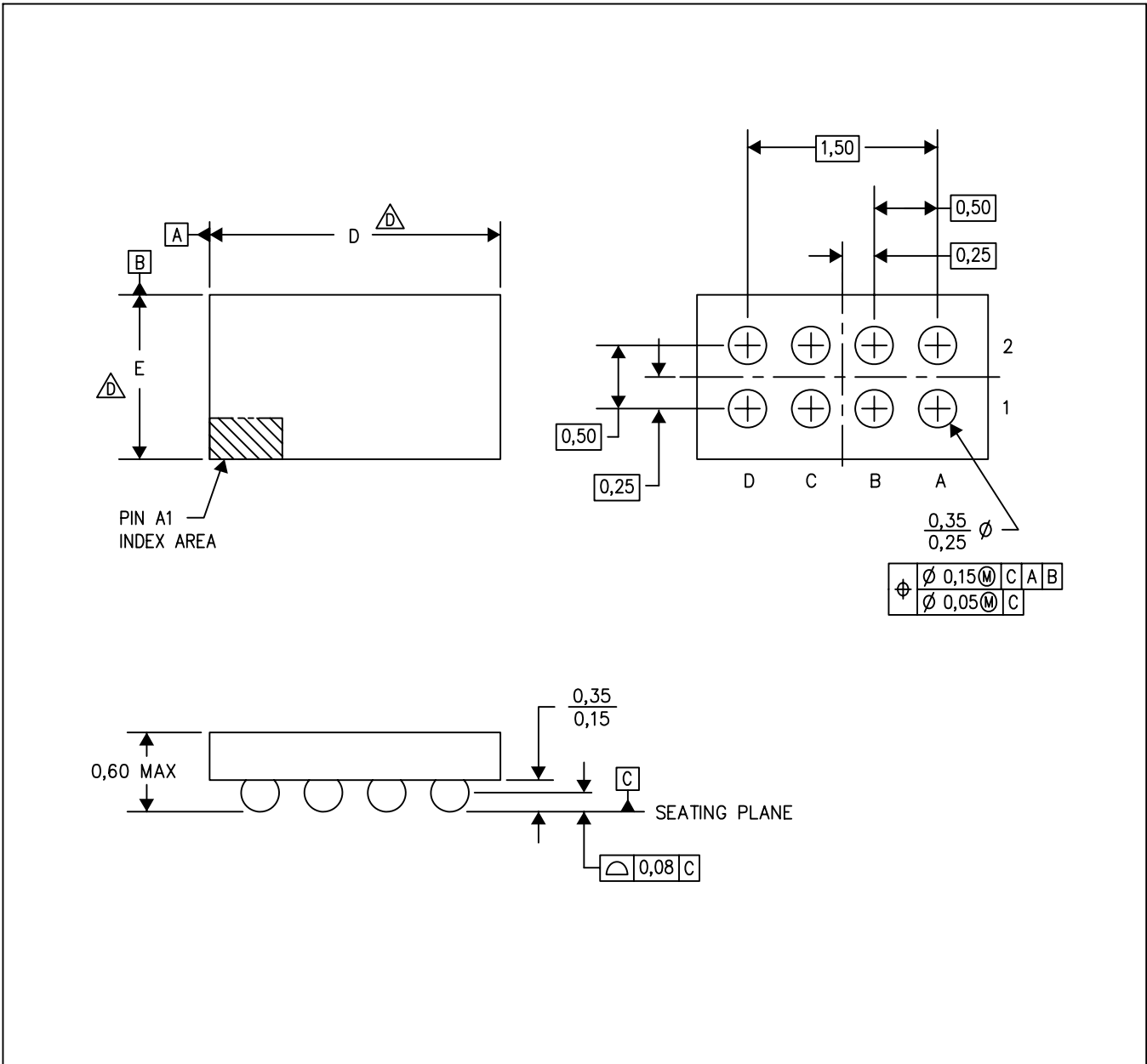

- NOTES:
- A. All linear dimensions are in millimeters.
  - B. This drawing is subject to change without notice.
  - C. NanoFree™ package configuration.
  - $\triangle$  Dimension D ranging from 1.85 to 2.65 mm and dimension E ranging from 0.85 to 1.65 mm. To determine the exact package size of a particular device, refer to the device datasheet or contact a local TI representative.

## YZ Wafer Chip-Scale Package Dimensions

**PACKAGING INFORMATION**

Orderable Device	Status (1)	Package Type	Package Drawing	Pins	Package Qty	Eco Plan (2)	Lead/Ball Finish (6)	MSL Peak Temp (3)	Op Temp (°C)	Device Marking (4/5)	Samples
TPS62300DRCR	ACTIVE	VSON	DRC	10	3000	Green (RoHS & no Sb/Br)	CU NIPDAU	Level-2-260C-1 YEAR	-40 to 85	AMN	<a href="#">Samples</a>
TPS62301DRCR	ACTIVE	VSON	DRC	10	3000	Green (RoHS & no Sb/Br)	CU NIPDAU	Level-2-260C-1 YEAR	-40 to 85	AMO	<a href="#">Samples</a>
TPS62301DRCRG4	ACTIVE	VSON	DRC	10	3000	Green (RoHS & no Sb/Br)	CU NIPDAU	Level-2-260C-1 YEAR	-40 to 85	AMO	<a href="#">Samples</a>
TPS62302DRCR	ACTIVE	VSON	DRC	10	3000	Green (RoHS & no Sb/Br)	CU NIPDAU	Level-2-260C-1 YEAR	-40 to 85	AMQ	<a href="#">Samples</a>
TPS62303DRCR	ACTIVE	VSON	DRC	10	3000	Green (RoHS & no Sb/Br)	CU NIPDAU	Level-2-260C-1 YEAR	-40 to 85	AMR	<a href="#">Samples</a>
TPS62304DRCR	ACTIVE	VSON	DRC	10	3000	Green (RoHS & no Sb/Br)	CU NIPDAU	Level-2-260C-1 YEAR	-40 to 85	AMS	<a href="#">Samples</a>
TPS62305DRCR	ACTIVE	VSON	DRC	10	3000	Green (RoHS & no Sb/Br)	CU NIPDAU	Level-2-260C-1 YEAR	-40 to 85	ANU	<a href="#">Samples</a>
TPS62320DRCR	ACTIVE	VSON	DRC	10	3000	Green (RoHS & no Sb/Br)	CU NIPDAU	Level-2-260C-1 YEAR	-40 to 85	AMX	<a href="#">Samples</a>
TPS62321DRCR	ACTIVE	VSON	DRC	10	3000	Green (RoHS & no Sb/Br)	CU NIPDAU	Level-2-260C-1 YEAR	-40 to 85	AMY	<a href="#">Samples</a>

(1) The marketing status values are defined as follows:

**ACTIVE:** Product device recommended for new designs.

**LIFEBUY:** TI has announced that the device will be discontinued, and a lifetime-buy period is in effect.

**NRND:** Not recommended for new designs. Device is in production to support existing customers, but TI does not recommend using this part in a new design.

**PREVIEW:** Device has been announced but is not in production. Samples may or may not be available.

**OBSOLETE:** TI has discontinued the production of the device.

(2) **RoHS:** TI defines "RoHS" to mean semiconductor products that are compliant with the current EU RoHS requirements for all 10 RoHS substances, including the requirement that RoHS substance do not exceed 0.1% by weight in homogeneous materials. Where designed to be soldered at high temperatures, "RoHS" products are suitable for use in specified lead-free processes. TI may reference these types of products as "Pb-Free".

**RoHS Exempt:** TI defines "RoHS Exempt" to mean products that contain lead but are compliant with EU RoHS pursuant to a specific EU RoHS exemption.

**Green:** TI defines "Green" to mean the content of Chlorine (Cl) and Bromine (Br) based flame retardants meet JS709B low halogen requirements of <=1000ppm threshold. Antimony trioxide based flame retardants must also meet the <=1000ppm threshold requirement.

(3) MSL, Peak Temp. - The Moisture Sensitivity Level rating according to the JEDEC industry standard classifications, and peak solder temperature.

(4) There may be additional marking, which relates to the logo, the lot trace code information, or the environmental category on the device.

(5) Multiple Device Markings will be inside parentheses. Only one Device Marking contained in parentheses and separated by a "~" will appear on a device. If a line is indented then it is a continuation of the previous line and the two combined represent the entire Device Marking for that device.

(6) Lead/Ball Finish - Orderable Devices may have multiple material finish options. Finish options are separated by a vertical ruled line. Lead/Ball Finish values may wrap to two lines if the finish value exceeds the maximum column width.

**Important Information and Disclaimer:**The information provided on this page represents TI's knowledge and belief as of the date that it is provided. TI bases its knowledge and belief on information provided by third parties, and makes no representation or warranty as to the accuracy of such information. Efforts are underway to better integrate information from third parties. TI has taken and continues to take reasonable steps to provide representative and accurate information but may not have conducted destructive testing or chemical analysis on incoming materials and chemicals. TI and TI suppliers consider certain information to be proprietary, and thus CAS numbers and other limited information may not be available for release.

In no event shall TI's liability arising out of such information exceed the total purchase price of the TI part(s) at issue in this document sold by TI to Customer on an annual basis.

**TAPE AND REEL INFORMATION**

**QUADRANT ASSIGNMENTS FOR PIN 1 ORIENTATION IN TAPE**

\*All dimensions are nominal

Device	Package Type	Package Drawing	Pins	SPQ	Reel Diameter (mm)	Reel Width W1 (mm)	A0 (mm)	B0 (mm)	K0 (mm)	P1 (mm)	W (mm)	Pin1 Quadrant
TPS62300DRCR	VSON	DRC	10	3000	330.0	12.4	3.3	3.3	1.1	8.0	12.0	Q2
TPS62301DRCR	VSON	DRC	10	3000	330.0	12.4	3.3	3.3	1.1	8.0	12.0	Q2
TPS62302DRCR	VSON	DRC	10	3000	330.0	12.4	3.3	3.3	1.1	8.0	12.0	Q2
TPS62303DRCR	VSON	DRC	10	3000	330.0	12.4	3.3	3.3	1.1	8.0	12.0	Q2
TPS62304DRCR	VSON	DRC	10	3000	330.0	12.4	3.3	3.3	1.1	8.0	12.0	Q2
TPS62305DRCR	VSON	DRC	10	3000	330.0	12.4	3.3	3.3	1.1	8.0	12.0	Q2
TPS62320DRCR	VSON	DRC	10	3000	330.0	12.4	3.3	3.3	1.1	8.0	12.0	Q2
TPS62321DRCR	VSON	DRC	10	3000	330.0	12.4	3.3	3.3	1.1	8.0	12.0	Q2

**TAPE AND REEL BOX DIMENSIONS**

\*All dimensions are nominal

Device	Package Type	Package Drawing	Pins	SPQ	Length (mm)	Width (mm)	Height (mm)
TPS62300DRCR	VSON	DRC	10	3000	350.0	350.0	43.0
TPS62301DRCR	VSON	DRC	10	3000	350.0	350.0	43.0
TPS62302DRCR	VSON	DRC	10	3000	350.0	350.0	43.0
TPS62303DRCR	VSON	DRC	10	3000	350.0	350.0	43.0
TPS62304DRCR	VSON	DRC	10	3000	350.0	350.0	43.0
TPS62305DRCR	VSON	DRC	10	3000	350.0	350.0	43.0
TPS62320DRCR	VSON	DRC	10	3000	350.0	350.0	43.0
TPS62321DRCR	VSON	DRC	10	3000	350.0	350.0	43.0

## IMPORTANT NOTICE AND DISCLAIMER

TI PROVIDES TECHNICAL AND RELIABILITY DATA (INCLUDING DATASHEETS), DESIGN RESOURCES (INCLUDING REFERENCE DESIGNS), APPLICATION OR OTHER DESIGN ADVICE, WEB TOOLS, SAFETY INFORMATION, AND OTHER RESOURCES "AS IS" AND WITH ALL FAULTS, AND DISCLAIMS ALL WARRANTIES, EXPRESS AND IMPLIED, INCLUDING WITHOUT LIMITATION ANY IMPLIED WARRANTIES OF MERCHANTABILITY, FITNESS FOR A PARTICULAR PURPOSE OR NON-INFRINGEMENT OF THIRD PARTY INTELLECTUAL PROPERTY RIGHTS.

These resources are intended for skilled developers designing with TI products. You are solely responsible for (1) selecting the appropriate TI products for your application, (2) designing, validating and testing your application, and (3) ensuring your application meets applicable standards, and any other safety, security, or other requirements. These resources are subject to change without notice. TI grants you permission to use these resources only for development of an application that uses the TI products described in the resource. Other reproduction and display of these resources is prohibited. No license is granted to any other TI intellectual property right or to any third party intellectual property right. TI disclaims responsibility for, and you will fully indemnify TI and its representatives against, any claims, damages, costs, losses, and liabilities arising out of your use of these resources.

TI's products are provided subject to TI's Terms of Sale ([www.ti.com/legal/termsofsale.html](http://www.ti.com/legal/termsofsale.html)) or other applicable terms available either on [ti.com](http://ti.com) or provided in conjunction with such TI products. TI's provision of these resources does not expand or otherwise alter TI's applicable warranties or warranty disclaimers for TI products.

Mailing Address: Texas Instruments, Post Office Box 655303, Dallas, Texas 75265  
Copyright © 2019, Texas Instruments Incorporated

## Looking for pricing, stock, or lifecycle information?

Click below to explore more details on WIN SOURCE:

 [View TPS62304YZDR on WIN SOURCE](#)

 [Texas Instruments](#) Information

## Optimize Your Supply Chain with WIN SOURCE Solutions

-  Global Sourcing Solution
-  Obsolete Management
-  Cost Control Management
-  Shortage Management
-  Alternative Solution
-  Excess Inventory Management