



THE DATASHEET OF 89CNQ150



**ULTRA LOW REVERSE LEAKAGE PLASTIC
POWER SCHOTTKY RECTIFIER
(135V-150V, 80A)**

Applications:

- Switching power supply • Converters • Free-Wheeling diodes • Reverse battery protection

Features:

- 175°C T_J operation
- Ultra low reverse leakage current
- Soft reverse recovery at low and high temperature
- Low forward voltage drop
- Low power loss, high efficiency
- High surge capacity
- Guard ring for enhanced ruggedness and long term reliability
- Guaranteed reverse avalanche characteristics
- This is a Pb – Free Device
- All SMC parts are traceable to the wafer lot
- Additional testing can be offered upon request

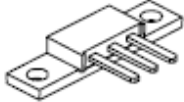
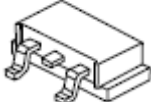
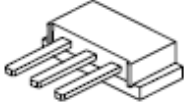
Case Styles		
89CNQ...  PRM2	89CNQ...SL  PRM2-SL	89CNQ...SM  PRM2-SM

Mechanical Dimensions: In Inches / mm

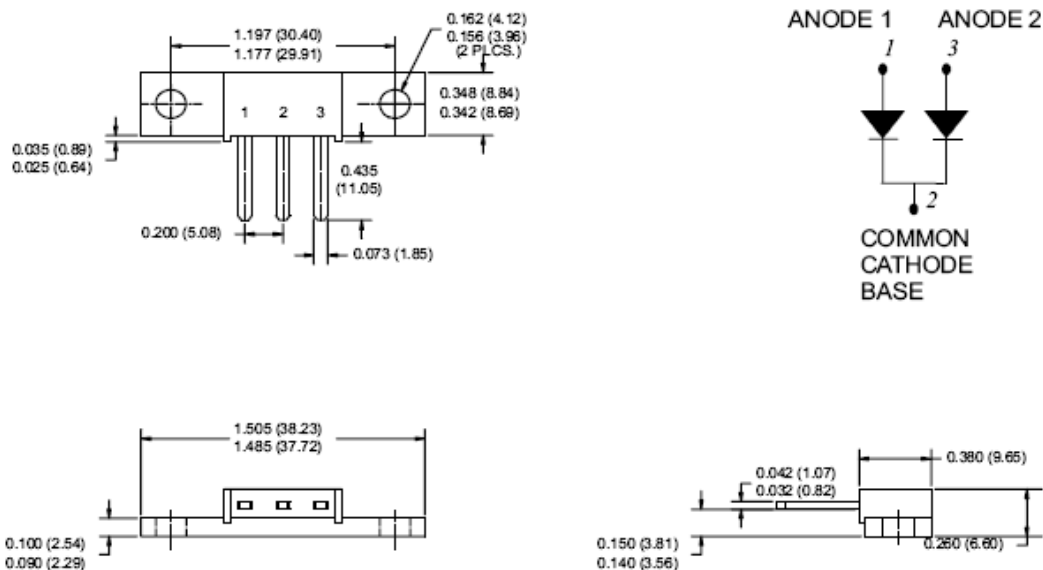

PRM2

- China - Germany - Korea - Singapore - United States •
- <http://www.smc-diodes.com> - sales@smc-diodes.com •

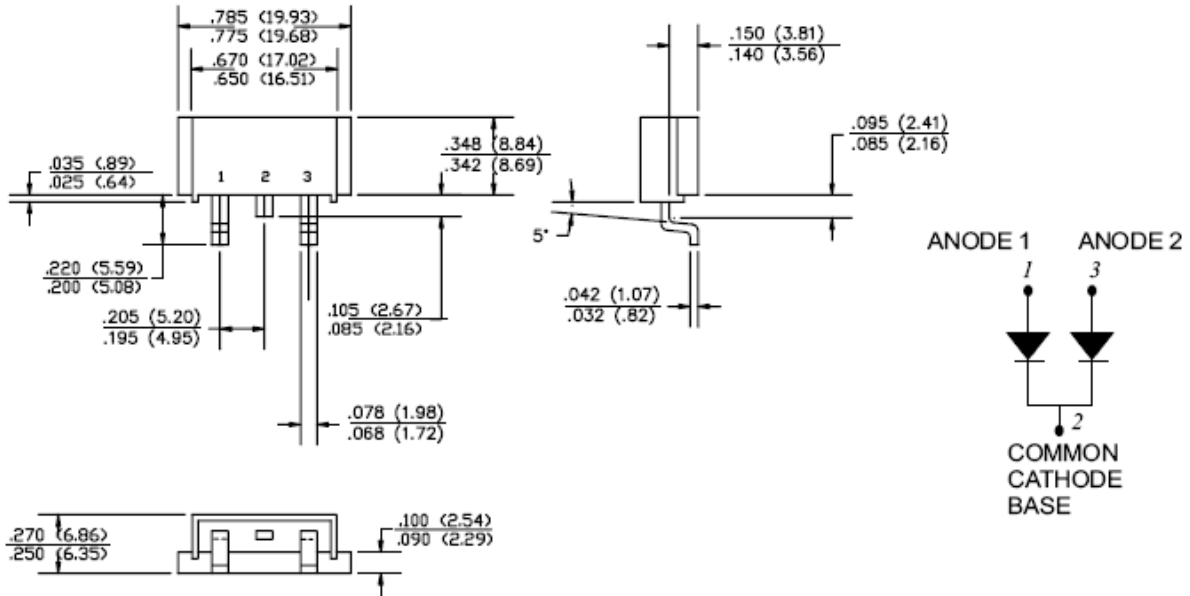

PRM2-SL

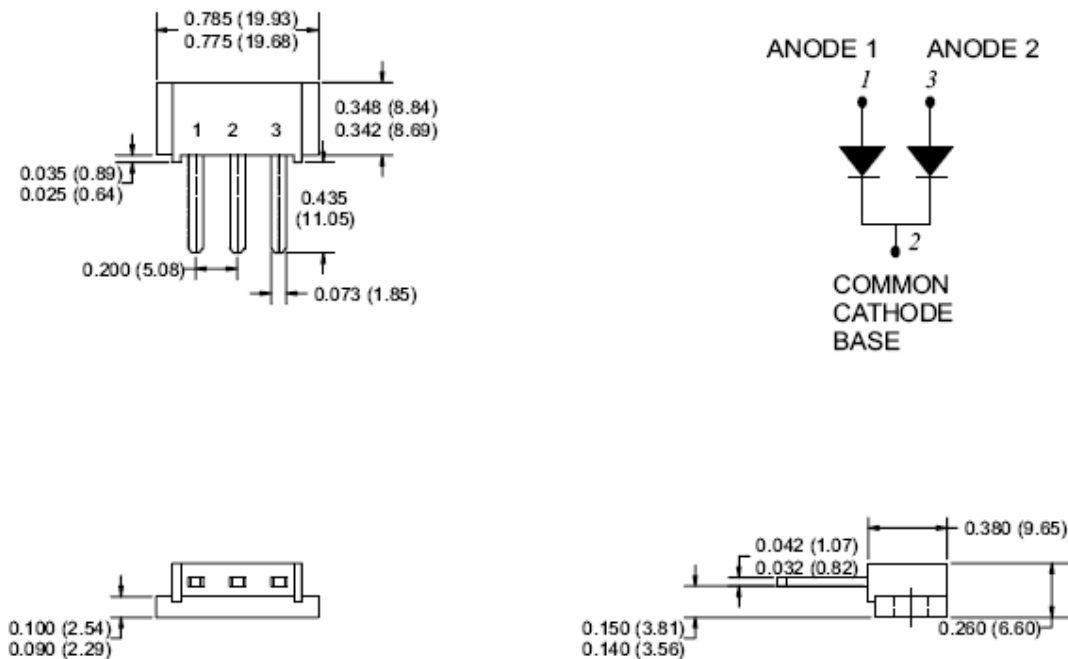

PRM2-SM

MARKING, MOLDING RESIN

Marking for 89CNQ135/SL/SM, 1st row SS YYWWL, 2nd row 89CNQ135/SL/SM, 3rd row 1 2 3 (pin)

Where YY is the manufacture year

WW is the manufacture week code

L is the wafer's Lot Number

Molding resin

Epoxy resin UL: 94V-0

- China - Germany - Korea - Singapore - United States •
- <http://www.smc-diodes.com> - sales@smc-diodes.com •



89CNQ SERIES

Technical Data
Data Sheet N1135, Rev. -

Green Products

Ordering Information:

Device	Package	Terminals finish	Shipping
89CNQ135	PRM2	Nickel plated	48pcs / box
89CNQ135S	PRM2	Pure Sn dipped (dipped height 6-8 mm)	48pcs / box
89CNQ135SL	PRM2-SL	Pure Sn plated	100pcs / box
89CNQ135SM	PRM2-SM	Nickel plated	48pcs / box
89CNQ135SMS	PRM2-SM	Pure Sn dipped (dipped height 6-8 mm)	48pcs / box
89CNQ150	PRM2	Nickel plated	48pcs / box
89CNQ150S	PRM2	Pure Sn dipped (dipped height 6-8 mm)	48pcs / box
89CNQ150SL	PRM2-SL	Pure Sn plated	100pcs / box
89CNQ150SM	PRM2-SM	Nickel plated	48pcs / box
89CNQ150SMS	PRM2-SM	Pure Sn dipped (dipped height 6-8 mm)	48pcs / box

For information on tape and reel specifications, including part orientation and tape sizes, please refer to our Tape and Reel Packaging Specification.

Maximum Ratings:

Characteristics	Symbol	Condition	Max.	Units
Peak Repetitive Reverse Voltage Working Peak Reverse Voltage DC Blocking Voltage	V_{RRM} V_{RWM} V_R	-	135(89CNQ135) 150(89CNQ150)	V
Average Forward Current	$I_{F(AV)}$	50% duty cycle @ $T_C = 132^\circ\text{C}$, rectangular wave form	80	A
Peak One Cycle Non-Repetitive Surge Current(per leg)	I_{FSM}	8.3 ms, half Sine pulse	708	A

- China - Germany - Korea - Singapore - United States •
- <http://www.smc-diodes.com> - sales@smc-diodes.com •



89CNQ SERIES

Technical Data
Data Sheet N1135, Rev. -

Green Products

Electrical Characteristics:

Characteristics	Symbol	Condition	Typ.	Max.	Units
Forward Voltage Drop (per leg) *	V_{F1}	@ 40A, Pulse, $T_J = 25\text{ }^\circ\text{C}$	0.82	0.99	V
		@ 80A, Pulse, $T_J = 25\text{ }^\circ\text{C}$	0.88	1.14	
	V_{F2}	@ 40A, Pulse, $T_J = 125\text{ }^\circ\text{C}$	0.62	0.69	V
		@ 80A, Pulse, $T_J = 125\text{ }^\circ\text{C}$	0.72	0.78	
Reverse Current (per leg) *	I_{R1}	@ $V_R = \text{rated } V_R$ $T_J = 25\text{ }^\circ\text{C}$	0.02	1.5	mA
	I_{R2}	@ $V_R = \text{rated } V_R$ $T_J = 125\text{ }^\circ\text{C}$	4	21	mA
Junction Capacitance (per leg)	C_T	@ $V_R = 5\text{V}$, $T_C = 25\text{ }^\circ\text{C}$ $f_{SIG} = 1\text{MHz}$, $V_{SIG} = 50\text{mV(p-p)}$	1200	1400	pF
Typical Series Inductance (per leg)	L_S	Measured lead to lead 5 mm from package body	5.5	-	nH
Voltage Rate of Change	dv/dt	-	-	10,000	V/ μs

* Pulse Width < 300 μs , Duty Cycle <2%

Thermal-Mechanical Specifications:

Characteristics	Symbol	Condition	Specification	Units
Junction Temperature	T_J	-	-55 to +175	$^\circ\text{C}$
Storage Temperature	T_{stg}	-	-55 to +175	$^\circ\text{C}$
Typical Thermal Resistance Junction to Case(per leg)	$R_{\theta JC}$	DC operation	0.85	$^\circ\text{C/W}$
Typical Thermal Resistance Junction to Case (per package)	$R_{\theta JC}$	DC operation	0.42	$^\circ\text{C/W}$
Typical Thermal Resistance, case to Heat Sink	$R_{\theta cs}$	Mounting surface, smooth and greased	0.30	$^\circ\text{C/W}$
Mounting Torque	T_M	-	40(min)	Kg-cm
			58(max)	
Approximate Weight	wt	-	7.8	g
Case Style	PRM2 PRM2-SL PRM2-SM			

- China - Germany - Korea - Singapore - United States •
- <http://www.smc-diodes.com> - sales@smc-diodes.com •

Typical Forward Characteristics

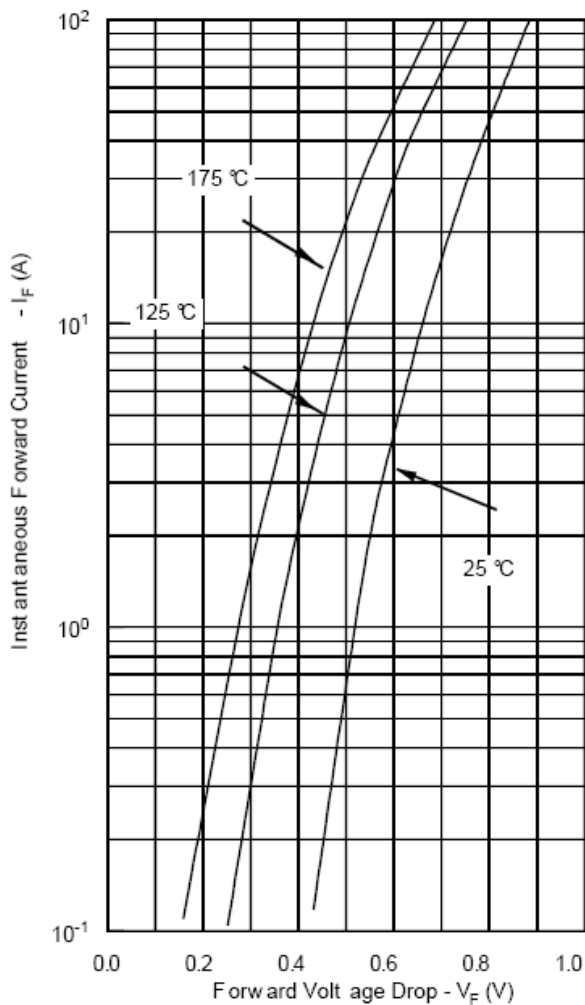

Typical Reverse Characteristics

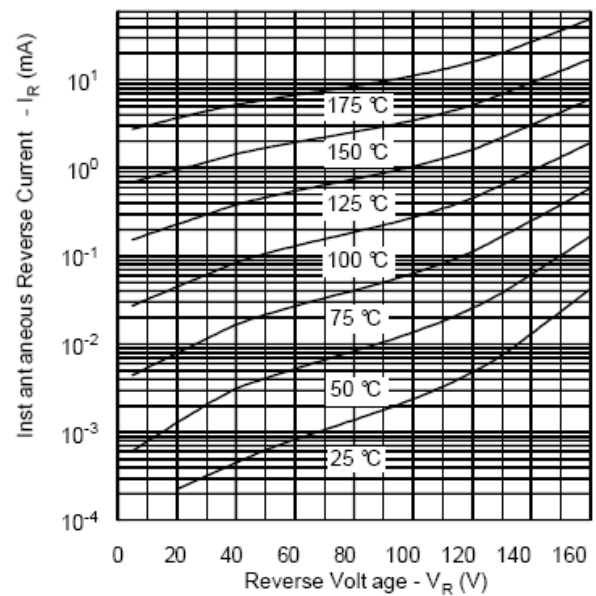

Typical Junction Capacitance

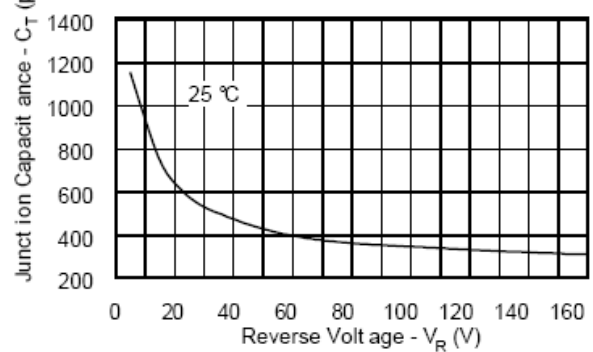



DISCLAIMER:

1- The information given herein, including the specifications and dimensions, is subject to change without prior notice to improve product characteristics. Before ordering, purchasers are advised to contact the SMC - Sangdest Microelectronics (Nanjing) Co., Ltd sales department for the latest version of the datasheet(s).

2- In cases where extremely high reliability is required (such as use in nuclear power control, aerospace and aviation, traffic equipment, medical equipment, and safety equipment), safety should be ensured by using semiconductor devices that feature assured safety or by means of users' fail-safe precautions or other arrangement.

3- In no event shall SMC - Sangdest Microelectronics (Nanjing) Co., Ltd be liable for any damages that may result from an accident or any other cause during operation of the user's units according to the datasheet(s). SMC - Sangdest Microelectronics (Nanjing) Co., Ltd assumes no responsibility for any intellectual property claims or any other problems that may result from applications of information, products or circuits described in the datasheets.

4- In no event shall SMC - Sangdest Microelectronics (Nanjing) Co., Ltd be liable for any failure in a semiconductor device or any secondary damage resulting from use at a value exceeding the absolute maximum rating.



5- No license is granted by the datasheet(s) under any patents or other rights of any third party or SMC - Sangdest Microelectronics (Nanjing) Co., Ltd.

6- The datasheet(s) may not be reproduced or duplicated, in any form, in whole or part, without the expressed written permission of SMC - Sangdest Microelectronics (Nanjing) Co., Ltd.

7- The products (technologies) described in the datasheet(s) are not to be provided to any party whose purpose in their application will hinder maintenance of international peace and safety nor are they to be applied to that purpose by their direct purchasers or any third party. When exporting these products (technologies), the necessary procedures are to be taken in accordance with related laws and regulations..

Looking for pricing, stock, or lifecycle information?

Click below to explore more details on WIN SOURCE:

-  [View 89CNQ150 on WIN SOURCE](#)
-  [SMC Diode Solutions](#) Information

Optimize Your Supply Chain with WIN SOURCE Solutions

-  Global Sourcing Solution
-  Obsolete Management
-  Cost Control Management
-  Shortage Management
-  Alternative Solution
-  Excess Inventory Management