

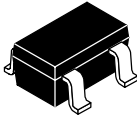

**THE DATASHEET OF
TPS72218DBVR**





LOW INPUT VOLTAGE, CAP FREE 50-mA LOW-DROPOUT LINEAR REGULATORS

FEATURES

- 50-mA LDO
- Available in 1.5-V, 1.6-V, and 1.8-V Fixed-Output and Adjustable Versions
- Low Input Voltage Requirement (Down to 1.8 V)
- Small Output Capacitor, 0.1- μ F
- Dropout Voltage Typically 50 mV at 50 mA
- Less Than 1 μ A Quiescent Current in Shutdown Mode
- Thermal Protection
- Over Current Limitation
- 5-Pin SOT-23 (DBV) Package

APPLICATIONS

- Portable Communication Devices
- Battery Powered Equipment
- PCMCIA Cards
- Personal Digital Assistants
- Modems
- Bar Code Scanners
- Backup Power Supplies
- SMPS Post Regulation
- Internet Audio

DESCRIPTION

The TPS722xx family of LDO regulators is available in fixed voltage options that are commonly used to power the latest DSP's and microcontrollers with an adjustable option ranging from 1.22 V to 2.5 V. These regulators can be used in a wide variety of applications ranging from portable, battery-powered equipment to PC peripherals. The family features operation over a wide range of input voltages (1.8 V to 5.5 V) and low dropout voltage (50 mV at full load). Therefore, compared to

many other regulators that require 2.5-V or higher input voltages for operation, these regulators can be operated directly from two AAA batteries. Also, the typical quiescent current (ground pin current) is low, starting at 85 μ A during normal operation and 1 μ A in shutdown mode. Thus, these regulators can be operated very efficiently and, in a battery-powered application, help extend the longevity of the device.

Similar LDO regulators require 1- μ F or larger output capacitors for stability. However, this regulator uses an internal compensation scheme that stabilizes the feedback loop over the full range of input voltages and load currents with output capacitances as low as 0.1- μ F. Ceramic capacitors of this size are relatively inexpensive and available in small footprints.

This family of regulators is particularly suited as a portable power supply solution due to its minimal board space requirement and 1.8-V minimum input voltage. Being able to use two off-the-shelf, AAA, batteries makes system design easier and also reduces component cost. Moreover, the solution will be more efficient than if a regulator with a higher input voltage is used.

DBV PACKAGE
(TOP VIEW)

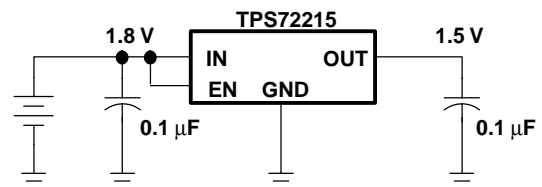
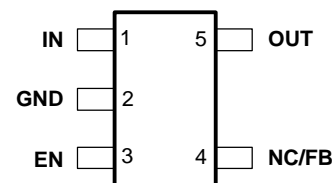

Please be aware that an important notice concerning availability, standard warranty, and use in critical applications of Texas Instruments semiconductor products and disclaimers thereto appears at the end of this data sheet.



These devices have limited built-in ESD protection. The leads should be shorted together or the device placed in conductive foam during storage or handling to prevent electrostatic damage to the MOS gates.

ORDERING INFORMATION

T _J	VOLTAGE	PACKAGE	PART NUMBER		SYMBOL
-40°C to 125°C	Adjustable	SOT-23 (DBV)	TPS72201DBVT ⁽¹⁾	TPS72201DBVR ⁽²⁾	PELI
	1.5 V		TPS72215DBVT ⁽¹⁾	TPS72215DBVR ⁽²⁾	PENI
	1.6 V		TPS72216DBVT ⁽¹⁾	TPS72216DBVR ⁽²⁾	PHGI
	1.8 V		TPS72218DBVT ⁽¹⁾	TPS72218DBVR ⁽²⁾	PEMI

(1) The DBVT indicates tape and reel of 250 parts.

(2) The DBVR indicates tape and reel of 3000 parts.

ABSOLUTE MAXIMUM RATINGS

over operating free-air temperature range unless otherwise noted⁽¹⁾

	TPS72201, TPS72215 TPS72216, TPS72218
Input voltage range ⁽¹⁾	-0.3 V to 7 V
Voltage range at EN	-0.3 V to 7 V
Voltage on OUT, FB, NC	-0.3 V to V _I + 0.3 V
Peak output current	Internally limited
ESD rating, HBM	3 kV
Continuous total power dissipation	See Dissipation Rating Table
Operating virtual junction temperature range, T _J	-40°C to 150°C
Storage temperature range, T _{stg}	-65°C to 150°C

(1) Stresses beyond those listed under “absolute maximum ratings” may cause permanent damage to the device. These are stress ratings only, and functional operation of the device at these or any other conditions beyond those indicated under “recommended operating conditions” is not implied. Exposure to absolute-maximum-rated conditions for extended periods may affect device reliability.

(2) All voltage values are with respect to network ground terminal.

PACKAGE DISSIPATION RATING

BOARD	PACKAGE	R _{θJC}	R _{θJA}	DERATING FACTOR ABOVE T _A = 25°C	T _A ≤ 25°C POWER RATING	T _A = 70°C POWER RATING	T _A = 85°C POWER RATING
Low K ⁽¹⁾	DBV	65.8 °C/W	259 °C/W	3.9 mW/°C	386 mW	212 mW	154 mW
High K ⁽²⁾	DBV	65.8 °C/W	180 °C/W	5.6 mW/°C	555 mW	305 mW	222 mW

(1) The JEDEC Low K (1s) board design used to derive this data was a 3 inch x 3 inch, two-layer board with 2 ounce copper traces on top of the board.

(2) The JEDEC High K (2s2p) board design used to derive this data was a 3 inch x 3 inch, multilayer board with 1 ounce internal power and ground planes and 2 ounce copper traces on top and bottom of the board.

ELECTRICAL CHARACTERISTICS

over recommended operating free-air temperature range, $V_I = V_{O(\text{typ})} + 1 \text{ V}$, $I_O = 1 \text{ mA}$, $EN = V_I$, $C_O = 4.7 \mu\text{F}$ (unless otherwise noted)

PARAMETER		TEST CONDITIONS		MIN	TYP	MAX	UNIT
V_I	Input voltage ⁽¹⁾			1.8		5.5	V
I_O	Continuous output current			0		50	mA
T_J	Operating junction temperature			-40		125	°C
V_O	Output voltage	TPS72201	$0 \mu\text{A} < I_O < 50 \text{ mA}$, ⁽¹⁾	$1.2 \text{ V} \leq V_O \leq 2.5 \text{ V}$	$0.97 V_O$	$1.03 V_O$	V
			$T_J = 25^\circ\text{C}$		1.5		
		TPS72215	$0 \mu\text{A} < I_O < 50 \text{ mA}$	$2.5 \text{ V} \leq V_I \leq 5.5 \text{ V}$	1.455	1.545	
			$T_J = 25^\circ\text{C}$		1.6		
		TPS72216	$0 \mu\text{A} < I_O < 50 \text{ mA}$	$2.6 \text{ V} \leq V_I \leq 5.5 \text{ V}$	1.552	1.648	
			$T_J = 25^\circ\text{C}$		1.8		
TPS72218	$0 \mu\text{A} < I_O < 50 \text{ mA}$	$2.5 \text{ V} \leq V_I \leq 5.5 \text{ V}$	1.746	1.854			
	$T_J = 25^\circ\text{C}$						
$I_{(Q)}$	Quiescent current (GND terminal current)	$T_J = 25^\circ\text{C}$			85		μA
						120	
		$I_O = 50 \text{ mA}$	$T_J = 25^\circ\text{C}$		275		
		$I_O = 50 \text{ mA}$				550	
Standby current	$EN < 0.5 \text{ V}$, $T_J = 25^\circ\text{C}$			0.01		μA	
	$EN < 0.5 \text{ V}$				1		
V_n	Output noise voltage	TPS72215	$BW = 200 \text{ Hz to } 100 \text{ kHz}$, $T_J = 25^\circ\text{C}$	$C_O = 1 \mu\text{F}$		90	μV
V_{ref}	Reference voltage	$T_J = 25^\circ\text{C}$			1.225		V
PSRR	Ripple rejection	$f = 100 \text{ Hz}$, $C_O = 10 \mu\text{F}$, $I_O = 50 \text{ mA}$		$T_J = 25^\circ\text{C}$, See Note 1		48	dB
Current limit		See Note 2			175	525	mA
Output voltage line regulation ($\Delta V_O/V_O$) ⁽³⁾		$V_O + 1 \text{ V} < V_I \leq 5.5 \text{ V}$		$T_J = 25^\circ\text{C}$	0.03	0.09	%V
						0.1	
	Output voltage load regulation	TPS72218	$0 < I_O < 50 \text{ mA}$, $T_J = 25^\circ\text{C}$		0.2		mV
V_{IH}	EN high level input				1.4		V
V_{IL}	EN low level input				-0.2	0.4	V
I_I	EN input current	$EN = 0 \text{ V}$			-0.01		μA
		$EN = IN$			-0.01		
V_{DO}	Dropout voltage ⁽⁴⁾	TPS72218	$I_O = 50 \text{ mA}$, $T_J = 25^\circ\text{C}$		50		mV
		TPS72201	$I_O = 50 \text{ mA}$, $1.2 \text{ V} \leq V_O \leq 5.2 \text{ V}$			100	
I_n	Feedback input current	TPS72201				1	μA
Thermal shutdown temperature					170		°C
Thermal shutdown hysteresis					20		°C

(1) Minimum I_N operating voltage is 1.8 V or $V_{O(\text{max})} + V_{DO}$ (max load), whichever is greater.

(2) Test condition includes, output voltage $V_O = 1 \text{ V}$ and pulse duration = 10 ms .

(3) $V_{I\text{max}} = 5.5 \text{ V}$, $V_{I\text{min}} = (V_O + 1)$ or 1.8 V whichever is greater.

$$\text{Line regulation (mV)} = (\%/\text{V}) \times \frac{V_O(5.5 \text{ V} - V_{I\text{min}})}{100} \times 1000$$

(4) Dropout voltage is defined as the differential voltage between V_O and V_I when V_O drops 100 mV below the value measured with $V_I = V_O + 1 \text{ V}$.

FUNCTIONAL BLOCK DIAGRAM—ADJUSTABLE VERSION

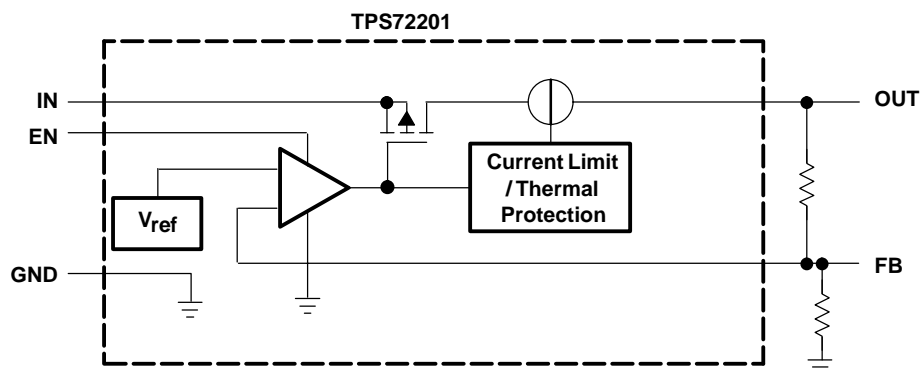

FUNCTIONAL BLOCK DIAGRAM—FIXED VERSION

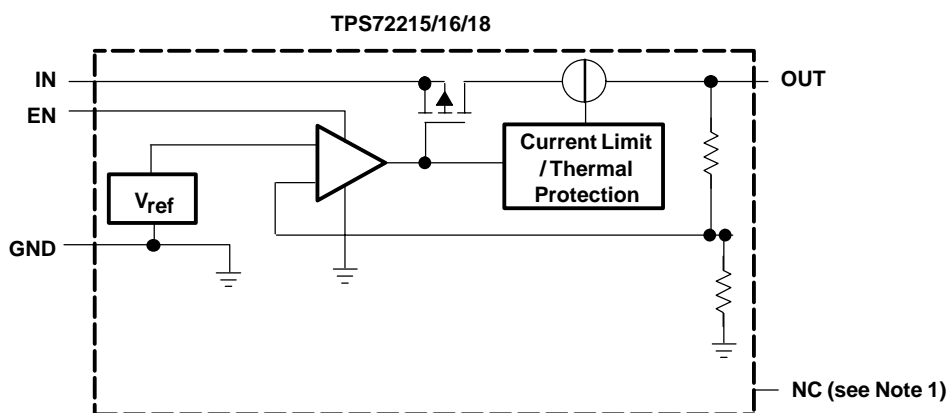

(1) This pin must be left floating and not connected to GND

Terminal Functions

TERMINAL NAME	NO.	I/O	DESCRIPTION
GND	2		Ground
EN	3	I	Enable input
IN	1	I	Input supply voltage
NC/FB	4	I	NC = Not connected (see Note 6); FB = Feedback (adjustable option TPS72201)
OUT	5	O	Regulated output voltage

TYPICAL CHARACTERISTICS

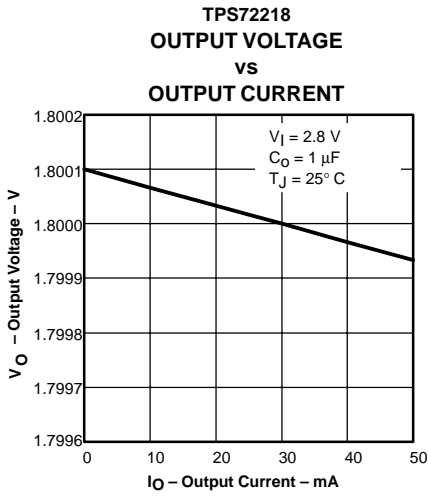

Figure 1

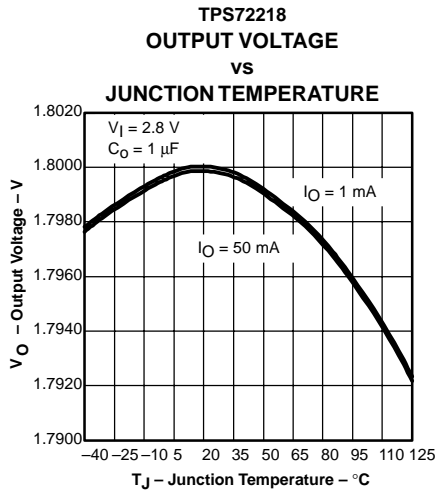

Figure 2

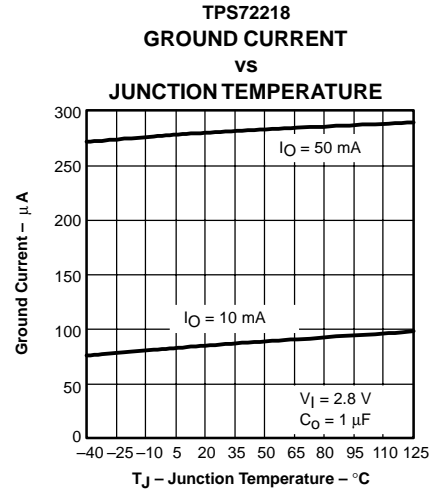

Figure 3

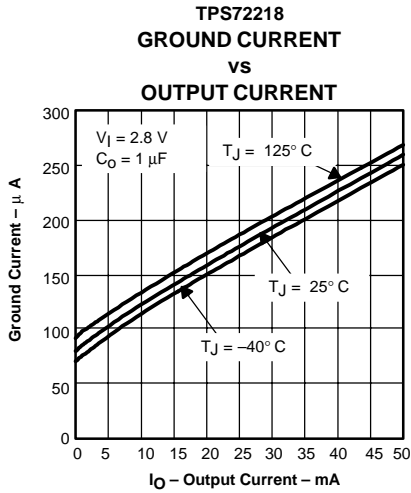

Figure 4

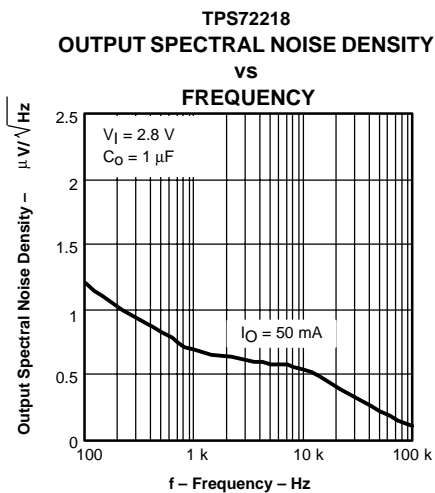

Figure 5

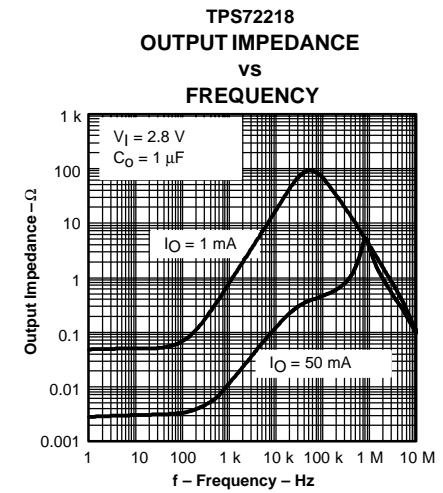

Figure 6

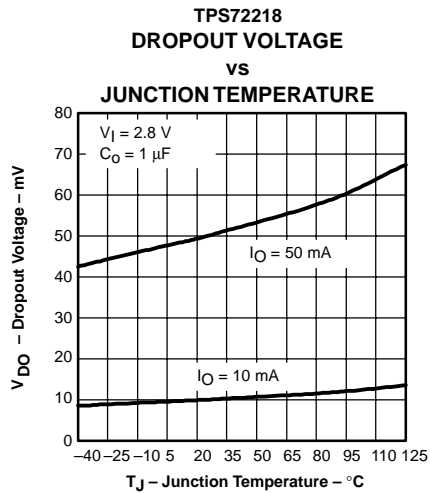

Figure 7

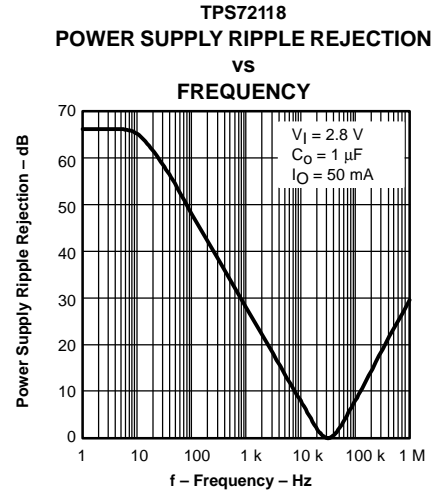

Figure 8

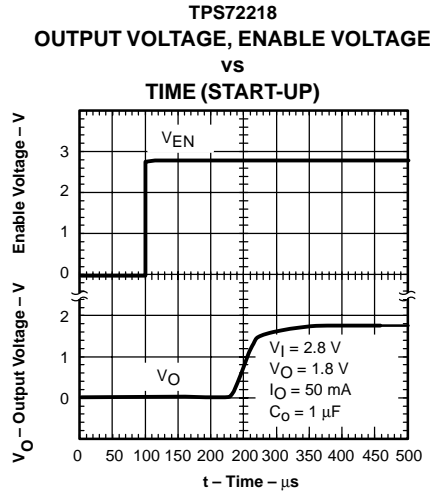

Figure 9

TYPICAL CHARACTERISTICS

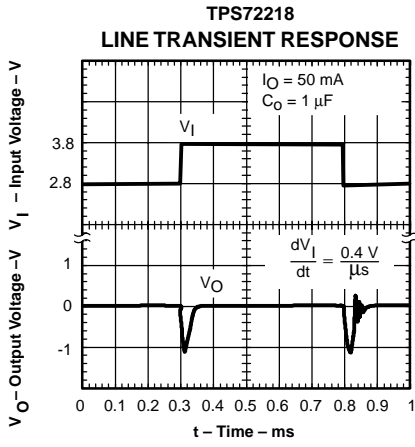

Figure 10

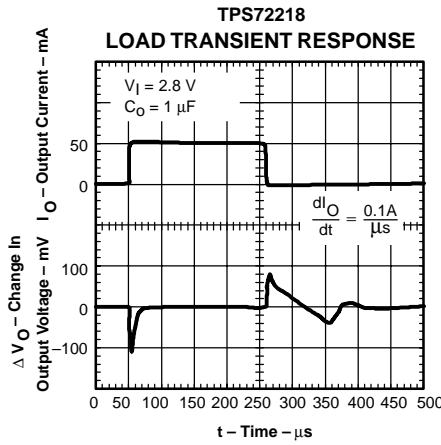

Figure 11

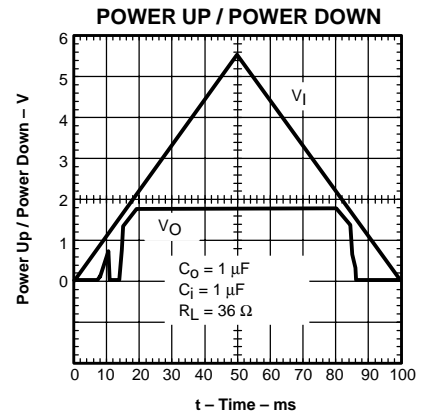

Figure 12

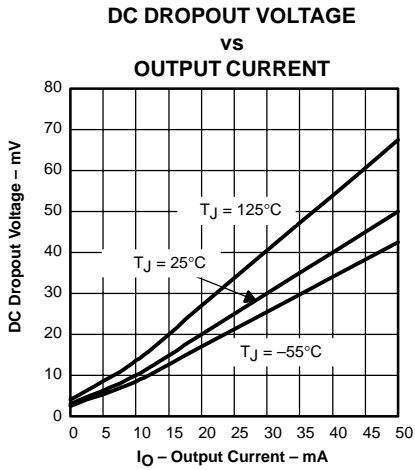

Figure 13

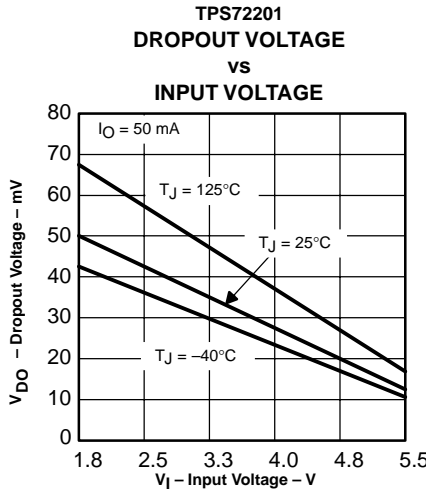

Figure 14

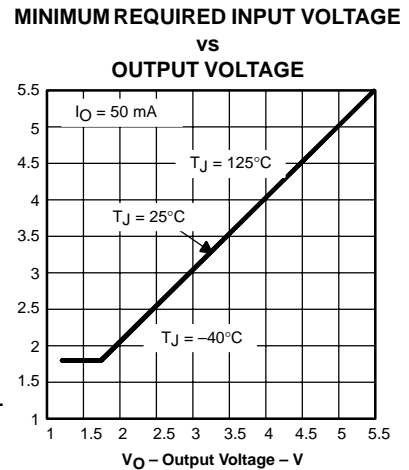

Figure 15

APPLICATION INFORMATION

The TPS722xx family of low-dropout (LDO) regulators functions with a very low input voltage (>1.8 V). The dropout voltage is typically 50 mV at full load. Typical quiescent current (ground pin current) is only 85 μA and drops to 1 μA in the shutdown mode.

DEVICE OPERATION

The TPS722xx family can be operated at low input voltages due to low voltage circuit design techniques and a PMOS pass element that exhibits low dropout.

A logic low on the enable input, EN, shuts off the output and reduces the supply current to less than 1 μA . EN may be tied to V_{IN} in applications where the shutdown feature is not used.

Current limiting and thermal protection prevent damage by excessive output current and/or power dissipation. The device switches into a constant-current mode at approximately 350 mA; further load reduces the output voltage instead of increasing the output current. The thermal protection shuts the regulator off if the junction temperature rises above 170°C. Recovery is automatic when the junction temperature drops approximately 20°C below the high temperature trip point. The PMOS pass element includes a back diode that safely conducts reverse current when the input voltage level drops below the output voltage level.

A typical application circuit is shown in Figure 16.

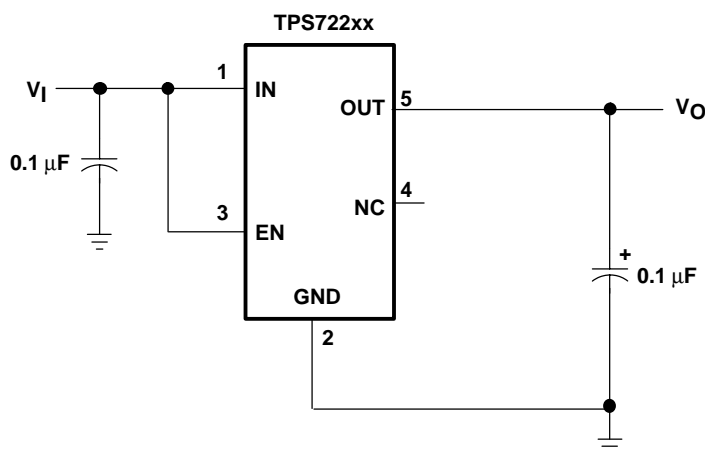

Figure 16. Typical Application Circuit

DUAL SUPPLY APPLICATION

In portable, battery-powered electronics, separate power rails for the DSP or microcontroller core voltage (V_{CORE}) and I/O peripherals (V_{IO}) are usually necessary. The TPS721xx family of LDO linear regulators is ideal for providing V_{CORE} for the DSP or microcontroller. As shown in Figure 17, two AAA batteries provide an input voltage to a boost converter and the TPS72115 LDO linear regulator. The batteries combine input voltage ranges from 3.0 V down to 1.8 V near the end of their useful lives. Therefore, a boost converter is necessary to provide the typical 3.3 V needed for V_{IO} , and the TPS72115 linear regulator provides a regulated V_{CORE} voltage, which in this example is 1.5 V. Although there is no explicit circuitry to perform power-up sequencing of first V_{CORE} then V_{IO} , the output of the linear regulator reaches its regulated voltage much faster (<400 μs) than the output of any switching type boost converter due to the inherent slow start up of those types of converters. Assuming a boost converter with minimum V_{I} of 1.8 V is appropriately chosen, this power supply solution can be used over the entire life of the two off-the-shelf AAA batteries. Thus, this solution is very efficient and the design time and overall cost of the solution is minimized.

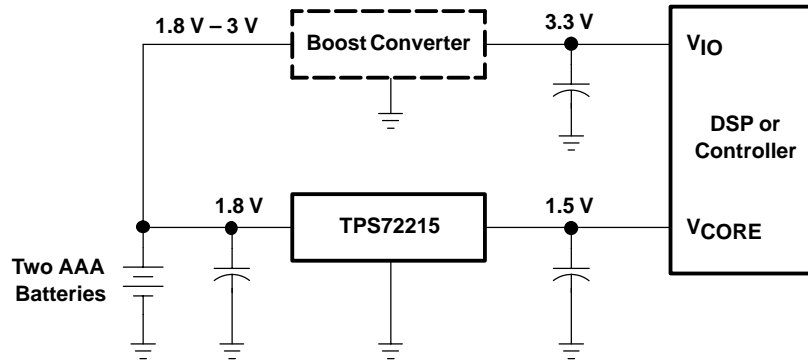

Figure 17. Dual Supply Application Circuit

EXTERNAL CAPACITOR REQUIREMENTS

A 0.1- μ F ceramic bypass capacitor is required on both the input and output for stability. Larger capacitors improve transient response, noise rejection, and ripple rejection. A higher value electrolytic input capacitor may be necessary if large, fast rise time load transient are anticipated, and/or there is significant input resistance from the device to the input power supply.

POWER DISSIPATION AND JUNCTION TEMPERATURE

Specified regulator operation is assured to a junction temperature of 125°C; the maximum junction temperature allowable without damaging the device is 150°C. This restriction limits the power dissipation the regulator can handle in any given application. To ensure the junction temperature is within acceptable limits, calculate the maximum allowable dissipation, $P_{D(max)}$, and the actual dissipation, P_D , which must be less than or equal to $P_{D(max)}$.

The maximum-power-dissipation limit is determined using the following equation:

$$P_{D(max)} = \frac{T_{Jmax} - T_A}{R_{\theta JA}}$$

Where:

T_{Jmax} is the maximum allowable junction temperature.

$R_{\theta JA}$ is the thermal resistance junction-to-ambient for the package, see the power dissipation rating table.

T_A is the ambient temperature.

The regulator dissipation is calculated using:

$$P_D = (V_I - V_O) \times I_O$$

Power dissipation resulting from quiescent current is negligible.

PROGRAMMING THE TPS72201 ADJUSTABLE LDO REGULATOR

The output voltage of the TPS72201 adjustable regulator is programmed using an external resistor divider as shown in Figure 18. The output voltage is calculated using:

$$V_O = V_{\text{ref}} \times \left(1 + \frac{R1}{R2}\right) \quad (1)$$

Where:

$$V_{\text{ref}} = 1.225 \text{ V typ (the internal reference voltage)}$$

Resistors R1 and R2 should be chosen for approximately 10- μ A divider current. Lower value resistors can be used but offer no inherent advantage and waste more power. Higher values should be avoided, as leakage currents at FB increase the output voltage error. The recommended design procedure is to choose R2 = 121 k Ω to set the divider current at 10 μ A and then calculate R1 using:

$$R1 = \left(\frac{V_O}{V_{\text{ref}}} - 1\right) \times R2 \quad (2)$$

Where:

$$V_{\text{ref}} = 1.225$$

OUTPUT VOLTAGE PROGRAMMING GUIDE		
OUTPUT VOLTAGE (V)	DIVIDER RESISTANCE (k Ω) [†]	
	R1	R2
2.5	127	121
3.3	205	121

[†] 1% values shown.

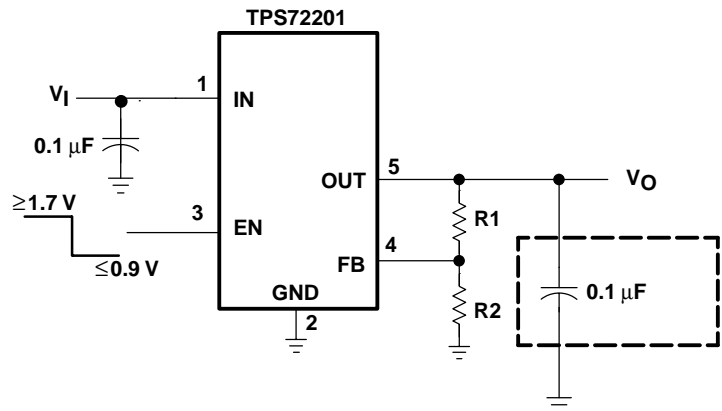

Figure 18. TPS72201 Adjustable LDO Regulator Programming

REGULATOR PROTECTION

The TPS722xx pass element has a built-in back diode that safely conducts reverse current when the input voltage drops below the output voltage (e.g., during power down). Current is conducted from the output to the input and is not internally limited. If extended reverse voltage is anticipated, external limiting might be appropriate.

The TPS722xx also features internal current limiting and thermal protection. During normal operation, the TPS722xx limits output current to approximately 350 mA. When current limiting engages, the output voltage scales back linearly until the overcurrent condition ends. While current limiting is designed to prevent gross device failure, care should be taken not to exceed the power dissipation ratings of the package. If the temperature of the device exceeds 170°C, thermal-protection circuitry shuts it down. Once the device has cooled down to below 150°C, regulator operation resumes.

PACKAGING INFORMATION

Orderable Device	Status (1)	Package Type	Package Drawing	Pins	Package Qty	Eco Plan (2)	Lead finish/ Ball material (6)	MSL Peak Temp (3)	Op Temp (°C)	Device Marking (4/5)	Samples
TPS72201DBVR	ACTIVE	SOT-23	DBV	5	3000	RoHS & Green	NIPDAU	Level-1-260C-UNLIM	-40 to 125	PELI	Samples
TPS72201DBVT	ACTIVE	SOT-23	DBV	5	250	RoHS & Green	NIPDAU	Level-1-260C-UNLIM	-40 to 125	PELI	Samples
TPS72215DBVT	ACTIVE	SOT-23	DBV	5	250	RoHS & Green	NIPDAU	Level-1-260C-UNLIM	-40 to 125	PENI	Samples
TPS72215DBVTG4	ACTIVE	SOT-23	DBV	5	250	RoHS & Green	NIPDAU	Level-1-260C-UNLIM	-40 to 125	PENI	Samples
TPS72216DBVT	ACTIVE	SOT-23	DBV	5	250	RoHS & Green	NIPDAU	Level-1-260C-UNLIM	-40 to 125	PHGI	Samples
TPS72218DBVR	ACTIVE	SOT-23	DBV	5	3000	RoHS & Green	NIPDAU	Level-1-260C-UNLIM	-40 to 125	PEMI	Samples
TPS72218DBVT	ACTIVE	SOT-23	DBV	5	250	RoHS & Green	NIPDAU	Level-1-260C-UNLIM	-40 to 125	PEMI	Samples
TPS72218DBVTG4	ACTIVE	SOT-23	DBV	5	250	RoHS & Green	NIPDAU	Level-1-260C-UNLIM	-40 to 125	PEMI	Samples

(1) The marketing status values are defined as follows:

ACTIVE: Product device recommended for new designs.

LIFEBUY: TI has announced that the device will be discontinued, and a lifetime-buy period is in effect.

NRND: Not recommended for new designs. Device is in production to support existing customers, but TI does not recommend using this part in a new design.

PREVIEW: Device has been announced but is not in production. Samples may or may not be available.

OBSOLETE: TI has discontinued the production of the device.

(2) **RoHS:** TI defines "RoHS" to mean semiconductor products that are compliant with the current EU RoHS requirements for all 10 RoHS substances, including the requirement that RoHS substance do not exceed 0.1% by weight in homogeneous materials. Where designed to be soldered at high temperatures, "RoHS" products are suitable for use in specified lead-free processes. TI may reference these types of products as "Pb-Free".

RoHS Exempt: TI defines "RoHS Exempt" to mean products that contain lead but are compliant with EU RoHS pursuant to a specific EU RoHS exemption.

Green: TI defines "Green" to mean the content of Chlorine (Cl) and Bromine (Br) based flame retardants meet JS709B low halogen requirements of <=1000ppm threshold. Antimony trioxide based flame retardants must also meet the <=1000ppm threshold requirement.

(3) MSL, Peak Temp. - The Moisture Sensitivity Level rating according to the JEDEC industry standard classifications, and peak solder temperature.

(4) There may be additional marking, which relates to the logo, the lot trace code information, or the environmental category on the device.

(5) Multiple Device Markings will be inside parentheses. Only one Device Marking contained in parentheses and separated by a "~" will appear on a device. If a line is indented then it is a continuation of the previous line and the two combined represent the entire Device Marking for that device.

⁽⁶⁾ Lead finish/Ball material - Orderable Devices may have multiple material finish options. Finish options are separated by a vertical ruled line. Lead finish/Ball material values may wrap to two lines if the finish value exceeds the maximum column width.

Important Information and Disclaimer:The information provided on this page represents TI's knowledge and belief as of the date that it is provided. TI bases its knowledge and belief on information provided by third parties, and makes no representation or warranty as to the accuracy of such information. Efforts are underway to better integrate information from third parties. TI has taken and continues to take reasonable steps to provide representative and accurate information but may not have conducted destructive testing or chemical analysis on incoming materials and chemicals. TI and TI suppliers consider certain information to be proprietary, and thus CAS numbers and other limited information may not be available for release.

In no event shall TI's liability arising out of such information exceed the total purchase price of the TI part(s) at issue in this document sold by TI to Customer on an annual basis.

TAPE AND REEL INFORMATION



QUADRANT ASSIGNMENTS FOR PIN 1 ORIENTATION IN TAPE



*All dimensions are nominal

Device	Package Type	Package Drawing	Pins	SPQ	Reel Diameter (mm)	Reel Width W1 (mm)	A0 (mm)	B0 (mm)	K0 (mm)	P1 (mm)	W (mm)	Pin1 Quadrant
TPS72201DBVR	SOT-23	DBV	5	3000	180.0	8.4	3.2	3.2	1.4	4.0	8.0	Q3
TPS72201DBVR	SOT-23	DBV	5	3000	178.0	9.0	3.23	3.17	1.37	4.0	8.0	Q3
TPS72201DBVT	SOT-23	DBV	5	250	180.0	8.4	3.2	3.2	1.4	4.0	8.0	Q3
TPS72201DBVT	SOT-23	DBV	5	250	178.0	9.0	3.23	3.17	1.37	4.0	8.0	Q3
TPS72215DBVT	SOT-23	DBV	5	250	178.0	9.0	3.23	3.17	1.37	4.0	8.0	Q3
TPS72216DBVT	SOT-23	DBV	5	250	180.0	8.4	3.2	3.2	1.4	4.0	8.0	Q3
TPS72218DBVR	SOT-23	DBV	5	3000	178.0	9.0	3.23	3.17	1.37	4.0	8.0	Q3
TPS72218DBVT	SOT-23	DBV	5	250	178.0	9.0	3.3	3.2	1.4	4.0	8.0	Q3

TAPE AND REEL BOX DIMENSIONS

*All dimensions are nominal

Device	Package Type	Package Drawing	Pins	SPQ	Length (mm)	Width (mm)	Height (mm)
TPS72201DBVR	SOT-23	DBV	5	3000	200.0	183.0	25.0
TPS72201DBVR	SOT-23	DBV	5	3000	180.0	180.0	18.0
TPS72201DBVT	SOT-23	DBV	5	250	203.0	203.0	35.0
TPS72201DBVT	SOT-23	DBV	5	250	180.0	180.0	18.0
TPS72215DBVT	SOT-23	DBV	5	250	180.0	180.0	18.0
TPS72216DBVT	SOT-23	DBV	5	250	200.0	183.0	25.0
TPS72218DBVR	SOT-23	DBV	5	3000	180.0	180.0	18.0
TPS72218DBVT	SOT-23	DBV	5	250	180.0	180.0	18.0

DBV0005A



PACKAGE OUTLINE

SOT-23 - 1.45 mm max height

SMALL OUTLINE TRANSISTOR

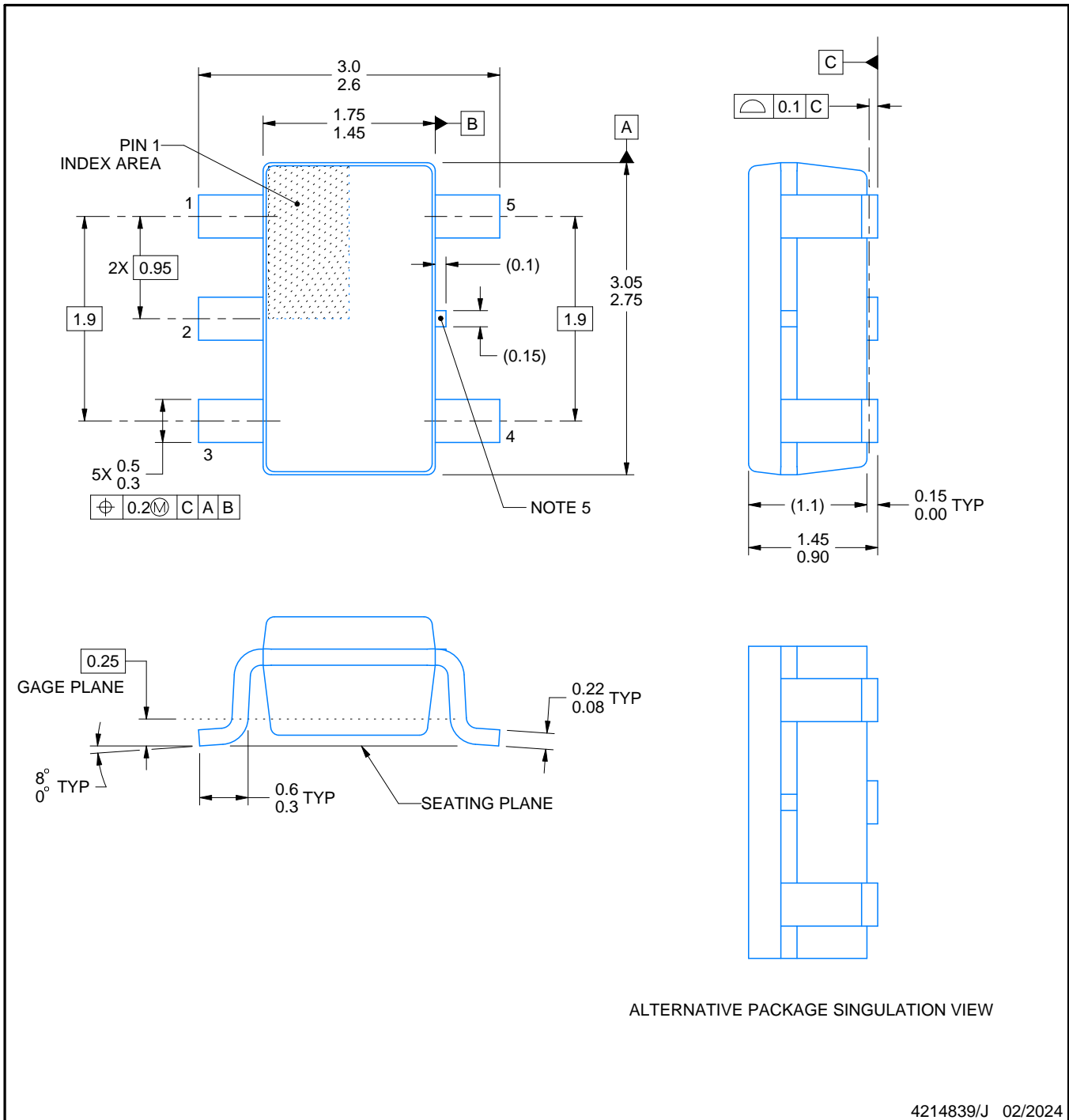

4214839/J 02/2024

NOTES:

- All linear dimensions are in millimeters. Any dimensions in parenthesis are for reference only. Dimensioning and tolerancing per ASME Y14.5M.
- This drawing is subject to change without notice.
- Reference JEDEC MO-178.
- Body dimensions do not include mold flash, protrusions, or gate burrs. Mold flash, protrusions, or gate burrs shall not exceed 0.25 mm per side.
- Support pin may differ or may not be present.

EXAMPLE BOARD LAYOUT

DBV0005A

SOT-23 - 1.45 mm max height

SMALL OUTLINE TRANSISTOR

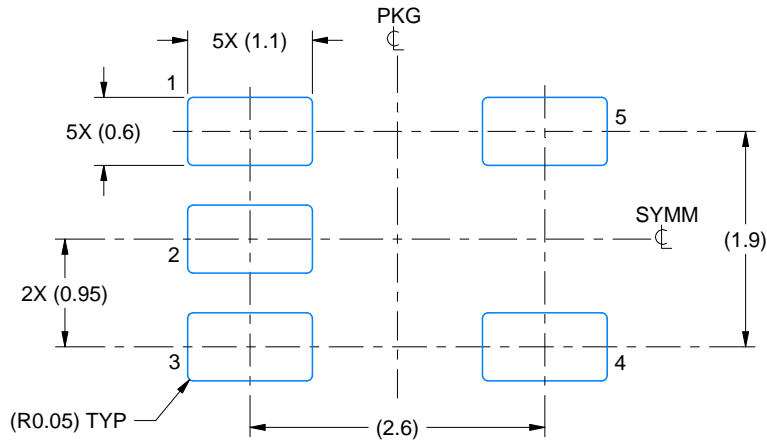

LAND PATTERN EXAMPLE
EXPOSED METAL SHOWN
SCALE:15X

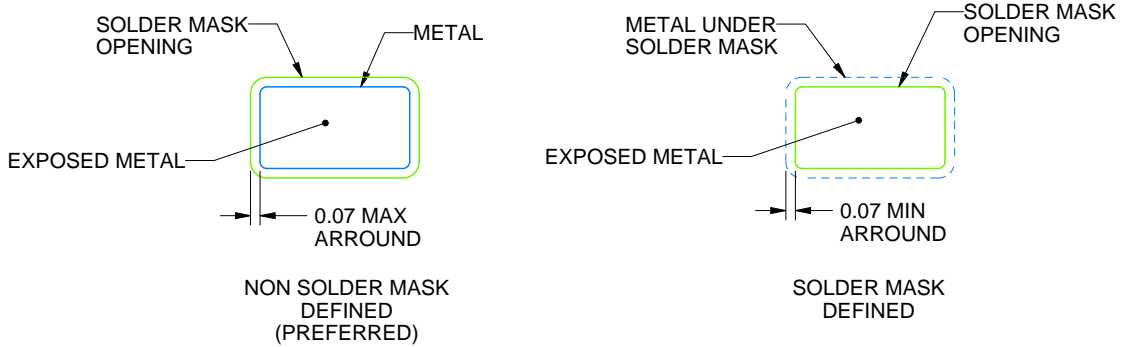

SOLDER MASK DETAILS

4214839/J 02/2024

NOTES: (continued)

- 6. Publication IPC-7351 may have alternate designs.
- 7. Solder mask tolerances between and around signal pads can vary based on board fabrication site.

EXAMPLE STENCIL DESIGN

DBV0005A

SOT-23 - 1.45 mm max height

SMALL OUTLINE TRANSISTOR

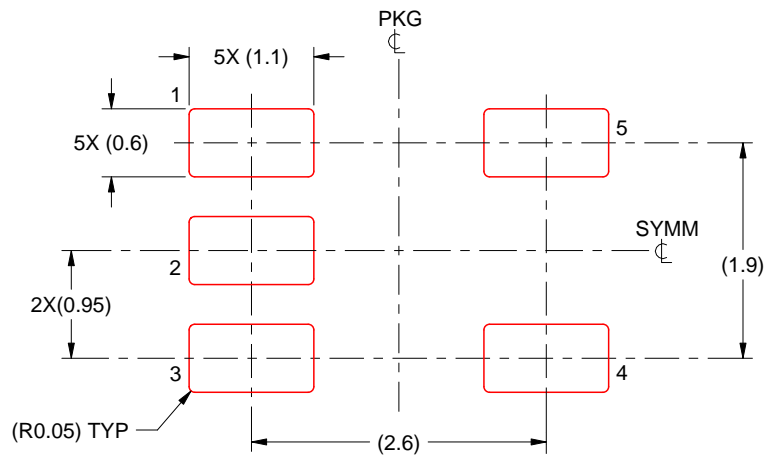

SOLDER PASTE EXAMPLE
BASED ON 0.125 mm THICK STENCIL
SCALE:15X

4214839/J 02/2024

NOTES: (continued)

8. Laser cutting apertures with trapezoidal walls and rounded corners may offer better paste release. IPC-7525 may have alternate design recommendations.
9. Board assembly site may have different recommendations for stencil design.

IMPORTANT NOTICE AND DISCLAIMER

TI PROVIDES TECHNICAL AND RELIABILITY DATA (INCLUDING DATA SHEETS), DESIGN RESOURCES (INCLUDING REFERENCE DESIGNS), APPLICATION OR OTHER DESIGN ADVICE, WEB TOOLS, SAFETY INFORMATION, AND OTHER RESOURCES "AS IS" AND WITH ALL FAULTS, AND DISCLAIMS ALL WARRANTIES, EXPRESS AND IMPLIED, INCLUDING WITHOUT LIMITATION ANY IMPLIED WARRANTIES OF MERCHANTABILITY, FITNESS FOR A PARTICULAR PURPOSE OR NON-INFRINGEMENT OF THIRD PARTY INTELLECTUAL PROPERTY RIGHTS.

These resources are intended for skilled developers designing with TI products. You are solely responsible for (1) selecting the appropriate TI products for your application, (2) designing, validating and testing your application, and (3) ensuring your application meets applicable standards, and any other safety, security, regulatory or other requirements.

These resources are subject to change without notice. TI grants you permission to use these resources only for development of an application that uses the TI products described in the resource. Other reproduction and display of these resources is prohibited. No license is granted to any other TI intellectual property right or to any third party intellectual property right. TI disclaims responsibility for, and you will fully indemnify TI and its representatives against, any claims, damages, costs, losses, and liabilities arising out of your use of these resources.

TI's products are provided subject to [TI's Terms of Sale](#) or other applicable terms available either on [ti.com](https://www.ti.com) or provided in conjunction with such TI products. TI's provision of these resources does not expand or otherwise alter TI's applicable warranties or warranty disclaimers for TI products.

TI objects to and rejects any additional or different terms you may have proposed.

Mailing Address: Texas Instruments, Post Office Box 655303, Dallas, Texas 75265
Copyright © 2024, Texas Instruments Incorporated

Looking for pricing, stock, or lifecycle information?

Click below to explore more details on WIN SOURCE:

 [View TPS72218DBVR](#) on WIN SOURCE

 [Texas Instruments](#) Information

Optimize Your Supply Chain with WIN SOURCE Solutions

-  Global Sourcing Solution
-  Obsolete Management
-  Cost Control Management
-  Shortage Management
-  Alternative Solution
-  Excess Inventory Management