



**THE DATASHEET OF
TPS73633MDBVREP**



CAP-FREE NMOS 400 mA LOW-DROPOUT REGULATORS WITH REVERSE CURRENT PROTECTION

FEATURES

- **Controlled Baseline**
 - One Assembly
 - One Test Site
 - One Fabrication Site
- **Extended Temperature Performance of –55°C to 125°C**
- **Enhanced Diminishing Manufacturing Sources (DMS) Support**
- **Enhanced Product-Change Notification**
- **Qualification Pedigree ⁽¹⁾**
- **Stable With No Output Capacitor or Any Value or Type of Capacitor**
- **Input Voltage Range of 1.7 V to 5.5 V**
- **Ultra-Low Dropout Voltage: 75 mV Typical**
- **Excellent Load Transient Response—With or Without Optional Output Capacitor**
- **New NMOS Topology Delivers Low Reverse Leakage Current**
- **Low Noise: 30 μ V_{RMS} Typical (10 Hz to 100 kHz)**
- **0.5% Initial Accuracy**
- **1% Overall Accuracy Over Line, Load, and Temperature**
- **Less Than 1- μ A Max I_Q in Shutdown Mode**
- **Thermal Shutdown and Specified Min/Max Current Limit Protection**
- **Available in Multiple Output Voltage Versions**
 - Fixed Outputs of 1.2 V to 3.3 V

- Adjustable Output from 1.2 V to 5.5 V
- Custom Outputs Available

APPLICATIONS

- **Portable/Battery-Powered Equipment**
- **Post-Regulation for Switching Supplies**
- **Noise-Sensitive Circuitry Such as VCOs**
- **Point of Load Regulation for DSPs, FPGAs, ASICs, and Microprocessors**

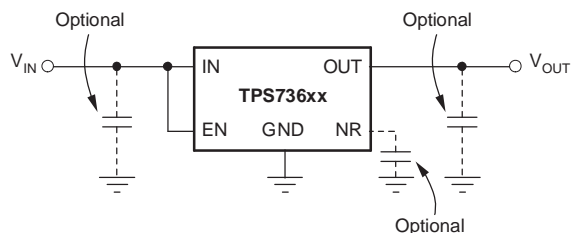

Typical Application Circuit for Fixed-Voltage Versions

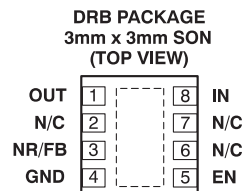
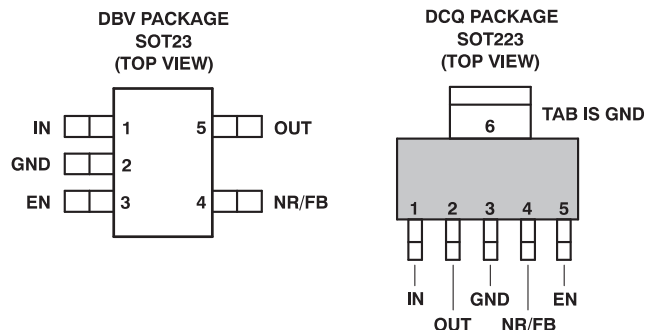

N/C - No internal connection

(1) Component qualification in accordance with JEDEC and industry standards to ensure reliable operation over an extended temperature range. This includes, but is not limited to, Highly Accelerated Stress Test (HAST) or biased 85/85, temperature cycle, autoclave or unbiased HAST, electromigration, bond intermetallic life, and mold compound life. Such qualification testing should not be viewed as justifying use of this component beyond specified performance and environmental limits.



Please be aware that an important notice concerning availability, standard warranty, and use in critical applications of Texas Instruments semiconductor products and disclaimers thereto appears at the end of this data sheet.

All trademarks are the property of their respective owners.

DESCRIPTION

The TPS736xx family of low-dropout (LDO) linear voltage regulators uses a new topology—an NMOS pass element in a voltage-follower configuration. This topology is stable using output capacitors with low ESR and allows operation without a capacitor. It also provides high reverse blockage (low reverse current) and ground-pin current that is nearly constant over all values of output current.

The TPS736xx uses an advanced BiCMOS process to yield high precision while delivering low dropout voltages and low ground-pin current. Current consumption, when not enabled, is under 1 μ A and ideal for portable applications. The low output noise (30 μ V_{RMS} with 0.1- μ F C_{NR}) is ideal for powering VCOs. These devices are protected by thermal shutdown and foldback current limit.



This integrated circuit can be damaged by ESD. Texas Instruments recommends that all integrated circuits be handled with appropriate precautions. Failure to observe proper handling and installation procedures can cause damage.

ESD damage can range from subtle performance degradation to complete device failure. Precision integrated circuits may be more susceptible to damage because very small parametric changes could cause the device not to meet its published specifications.

PRODUCT INFORMATION

PRODUCT	V _{OUT} ⁽¹⁾
TPS736xxMyyyREP	xx is normal output voltage (for example, 25 = 2.5 V, 01 = Adjustable ⁽²⁾). yyy is package designator. z is package quantity.

- (1) Additional output voltages from 1.25 V to 4.3 V in 100 mV increments are available on a quick-turn basis using innovative factory EEPROM programming. Minimum order quantities apply; contact TI for details and availability.
 (2) For fixed 1.2-V operation, tie FB to OUT.

ORDERING INFORMATION⁽¹⁾

T _A	PACKAGE ⁽²⁾	ORDERABLE PART NUMBER	TOP-SIDE MARKING
-55°C to 125°C	SOT23 - DBV	TPS73601MDBVREP	PJRM
		TPS73615MDBVREP	T59
		TPS73618MDBVREP	T60
		TPS73625MDBVREP	T61
		TPS73630MDBVREP	T62
		TPS73632MDBVREP	T63
		TPS73633MDBVREP	T64
	SOT223 - DCQ	TPS73601MDCQREP	PWZM
	SON - DRB	TPS73601MDRBREP	PMNM

- (1) For the most current package and ordering information, see the Package Option Addendum at the end of this document, or see the TI website at www.ti.com.
 (2) Package drawings, thermal data, and symbolization are available at www.ti.com/packaging.

TERMINAL FUNCTIONS

NAME	SOT23 (DBV) PIN NO.	SOT223 (DCQ) PIN NO.	3x3 SON (DRB) PIN NO.	DESCRIPTION
IN	1	1	8	Unregulated input supply
GND	2	3, 6	4, Pad	Ground
EN	3	5	5	Enable. Driving EN high turns on the regulator. Driving this pin low puts the regulator into shutdown mode. See the Shutdown section under Applications Information for more details. EN can be connected to IN if not used.
NR	4	4	3	Fixed-voltage versions only. Connecting an external capacitor to this pin bypasses noise generated by the internal bandgap, reducing output noise to low levels.
FB	4	4	3	Feedback. Adjustable-voltage version only. This is the input to the control loop error amplifier and is used to set the output voltage of the device.
OUT	5	2	1	Output of the regulator. There are no output capacitor requirements for stability.

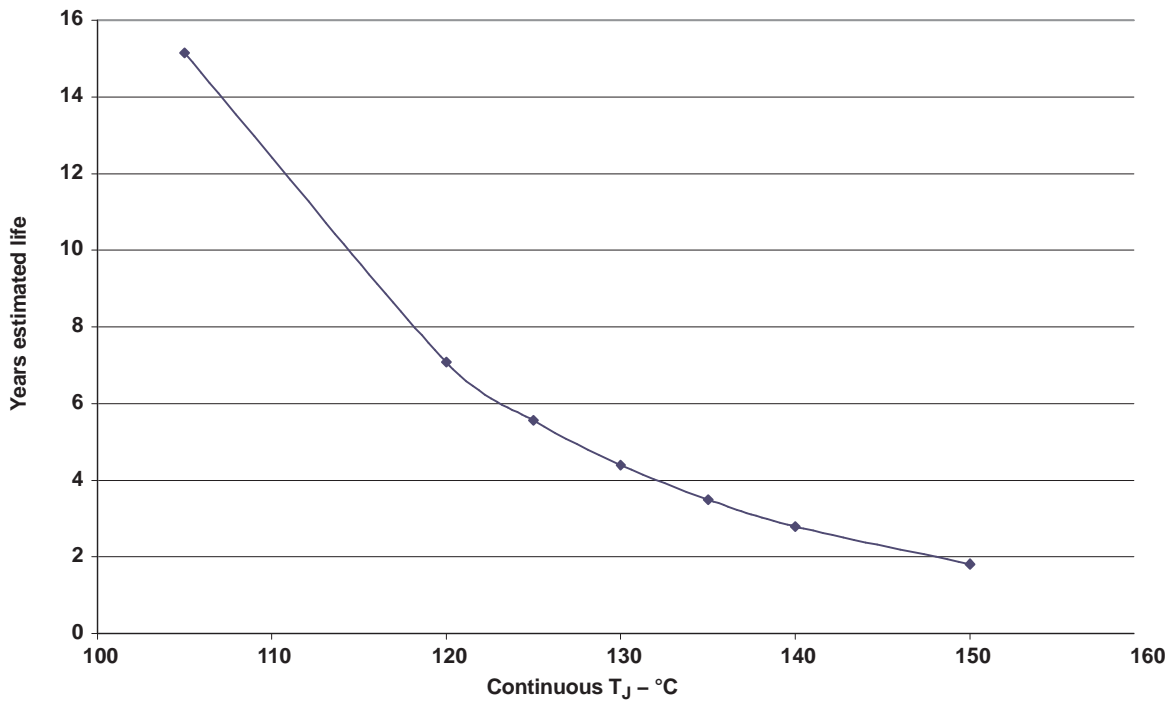

A. $T_J = T_{JA} \times W + T_A$ (Standard. JESD 51 conditions)

Figure 1. TPS736xxDBVzEP Estimated Device Life at Elevated Temperatures Electromigration Fail Mode

ABSOLUTE MAXIMUM RATINGS

over operating free-air temperature range unless otherwise noted⁽¹⁾

			UNIT
V _{IN} range		–0.3 to 6	V
V _{EN} range		–0.3 to 6	V
V _{OUT} range		–0.3 to 5.5	V
Peak output current		Internally limited	
Output short-circuit duration		Indefinite	
Continuous total power dissipation		See Dissipation Ratings Table	
Junction temperature range, T _J		–55 to 150	°C
Storage temperature range		–65 to 150	°C
ESD rating	Human-Body Model - HBM	2	kV
	Charged-Device Model - CDM	500	V

- (1) Stresses beyond those listed under Absolute Maximum Ratings may cause permanent damage to the device. These are stress ratings only, and functional operation of the device at these or any other conditions beyond those indicated under the Electrical Characteristics is not implied. Exposure to absolute maximum rated conditions for extended periods may affect device reliability.

POWER DISSIPATION RATINGS⁽¹⁾

BOARD	PACKAGE	R _{θJC}	R _{θJA}	DERATING FACTOR ABOVE T _A = 25°C	T _A ≤ 25°C POWER RATING	T _A = 70°C POWER RATING	T _A = 85°C POWER RATING
Low-K ⁽²⁾	DBV	64°C/W	255°C/W	3.9 mW/°C	392 mW	216 mW	157 mW
High-K ⁽³⁾	DBV	64°C/W	180°C/W	5.6 mW/°C	556 mW	306 mW	222 mW
Low-K ⁽²⁾	DCQ	15°C/W	53°C/W	18.9 mW/°C	1887 mW	1038 mW	755 mW
High-K ⁽³⁾	DCQ	15°C/W	45°C/W	22.2 mW/°C	2222 mW	1222 mW	889 mW
High-K ⁽³⁾⁽⁴⁾	DRB	1.2°C/W	40°C/W	25.0 mW/°C	2500 mW	1375 mW	1000 mW

- (1) See the Thermal Protection section for more information related to thermal design.
 (2) The JEDEC Low-K (1s) board design used to derive this data was a 3 in × 3 in, two-layer board with 2 oz copper traces on top of the board.
 (3) The JEDEC High-K (2s2p) board design used to derive this data was a 3 in × 3 in, multilayer board with 1 oz internal power and ground planes, and 2-oz copper traces on the top and bottom of the board.
 (4) Based on preliminary thermal simulations.

ELECTRICAL CHARACTERISTICS

over operating temperature range ($T_A = -55^{\circ}\text{C}$ to 125°C), $V_{IN} = V_{OUT(nom)} + 0.5\text{ V}^{(1)}$, $I_{OUT} = 10\text{ mA}$, $V_{EN} = 1.7\text{ V}$, and $C_{OUT} = 0.1\text{ }\mu\text{F}$ (unless otherwise noted). Typical values are at $T_J = 25^{\circ}\text{C}$.

PARAMETER		TEST CONDITIONS	MIN	TYP	MAX	UNIT
V_{IN}	Input voltage range ^{(1) (2)}		1.7		5.5	V
V_{FB}	Internal reference (TPS73601)	$T_J = 25^{\circ}\text{C}$	1.198	1.2	1.21	V
V_{OUT}	Output voltage range (TPS73601)		V_{FB}		$5.5 - V_{DO}$	V
	Accuracy ⁽¹⁾	Nominal	$T_J = 25^{\circ}\text{C}$	-0.5%		0.5%
Over V_{IN} , I_{OUT} , and T		$V_{OUT} + 0.5\text{ V} \leq V_{IN} \leq 5.5\text{ V}$, $10\text{ mA} \leq I_{OUT} \leq 400\text{ mA}$		-1%	$\pm 0.5\%$	1%
$\Delta V_{OUT}\%/\Delta V_{IN}$	Line regulation ⁽¹⁾	$V_{O(nom)} + 0.5\text{ V} \leq V_{IN} \leq 5.5\text{ V}$		0.01		%/V
$\Delta V_{OUT}\%/\Delta I_{OUT}$	Load regulation	$1\text{ mA} \leq I_{OUT} \leq 400\text{ mA}$		0.002		%mA
		$10\text{ mA} \leq I_{OUT} \leq 400\text{ mA}$		0.0005		
V_{DO}	Dropout voltage ⁽³⁾ ($V_{IN} = V_{OUT(nom)} - 0.1\text{ V}$)	$I_{OUT} = 400\text{ mA}$		75	200	mV
$Z_O(\text{DO})$	Output impedance in dropout	$1.7\text{ V} \leq V_{IN} \leq V_{OUT} + V_{DO}$		0.25		Ω
I_{CL}	Output current limit	$V_{OUT} = 0.9 \times V_{OUT(nom)}$	400	650	800	mA
I_{SC}	Short-circuit current	$V_{OUT} = 0\text{ V}$		450		mA
I_{REV}	Reverse leakage current ⁽⁴⁾ ($-I_{IN}$)	$V_{EN} \leq 0.5\text{ V}$, $0\text{ V} \leq V_{IN} \leq V_{OUT}$		0.1	15	μA
I_{GND}	Ground-pin current	$I_{OUT} = 10\text{ mA}$ (I_Q)		400	550	μA
		$I_{OUT} = 400\text{ mA}$		800	1000	
I_{SHDN}	Shutdown current (I_{GND})	$V_{EN} \leq 0.5\text{ V}$, $V_{OUT} \leq V_{IN} \leq 5.5\text{ V}$		0.02	1	μA
I_{FB}	FB pin current (TPS73601)			0.1	0.45	μA
PSRR	Power-supply rejection ratio (ripple rejection)	$f = 100\text{ Hz}$, $I_{OUT} = 400\text{ mA}$		58		dB
		$f = 10\text{ kHz}$, $I_{OUT} = 400\text{ mA}$		37		
V_N	Output noise voltage BW = 10 Hz to 100 kHz	$C_{OUT} = 10\text{ }\mu\text{F}$, No C_{NR}		$27 \times V_{OUT}$		μV_{RMS}
		$C_{OUT} = 10\text{ }\mu\text{F}$, $C_{NR} = 0.01\text{ }\mu\text{F}$		$8.5 \times V_{OUT}$		
t_{STR}	Startup time	$V_{OUT} = 3\text{ V}$, $R_L = 30\text{ }\Omega$, $C_{OUT} = 1\text{ }\mu\text{F}$, $C_{NR} = 0.01\text{ }\mu\text{F}$		600		μs
$V_{EN}(\text{HI})$	Enable high (enabled)		1.7		V_{IN}	V
$V_{EN}(\text{LO})$	Enable low (shutdown)		0		0.5	V
$I_{EN}(\text{HI})$	Enable pin current (enabled)	$V_{EN} = 5.5\text{ V}$		0.02	0.1	μA
T_{SD}	Thermal shutdown temperature	Shutdown, temperature increasing		160		$^{\circ}\text{C}$
		Reset, temperature decreasing		140		
T_A	Operating ambient temperature		-55		125	$^{\circ}\text{C}$

(1) Minimum $V_{IN} = V_{OUT} + V_{DO}$ or 1.7 V , whichever is greater.

(2) For $V_{OUT(nom)} < 1.6\text{ V}$, when $V_{IN} \leq 1.6\text{ V}$, the output locks to V_{IN} and may result in a damaging over-voltage level on the output. To avoid this situation, disable the device before powering down the V_{IN} .

(3) V_{DO} is not measured for the TPS73615 ($V_{OUT(nom)} = 1.5\text{ V}$) since minimum $V_{IN} = 1.7\text{ V}$.

(4) See the [Applications](#) section for more information.

FUNCTIONAL BLOCK DIAGRAMS

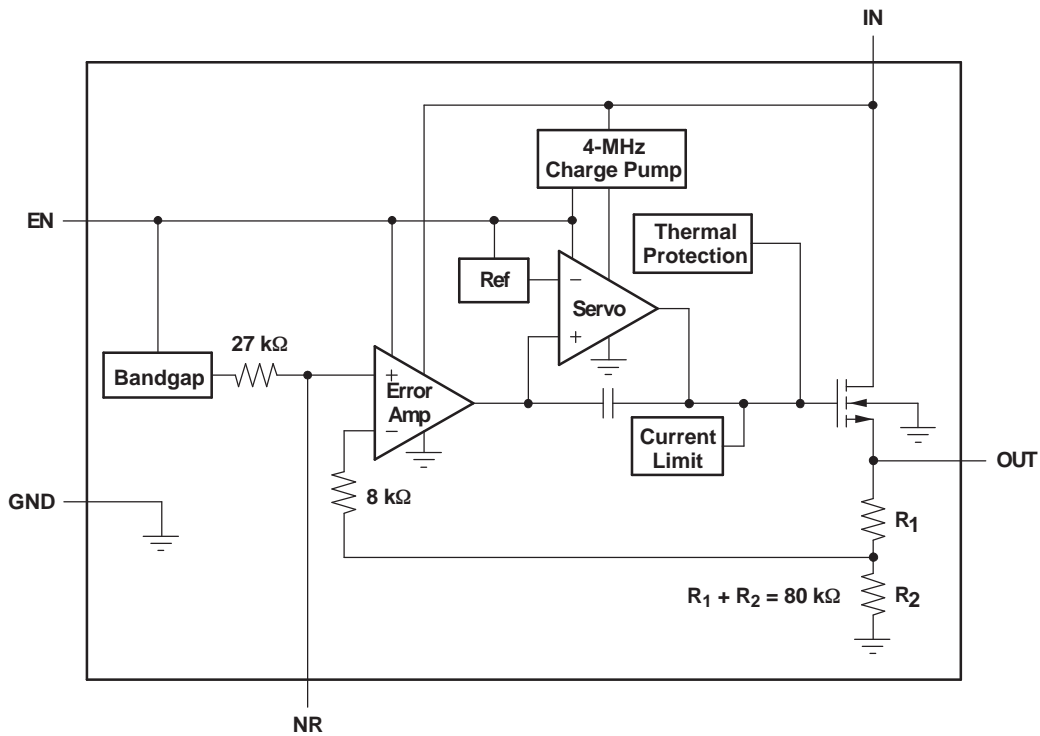

Figure 2. Fixed-Voltage Version

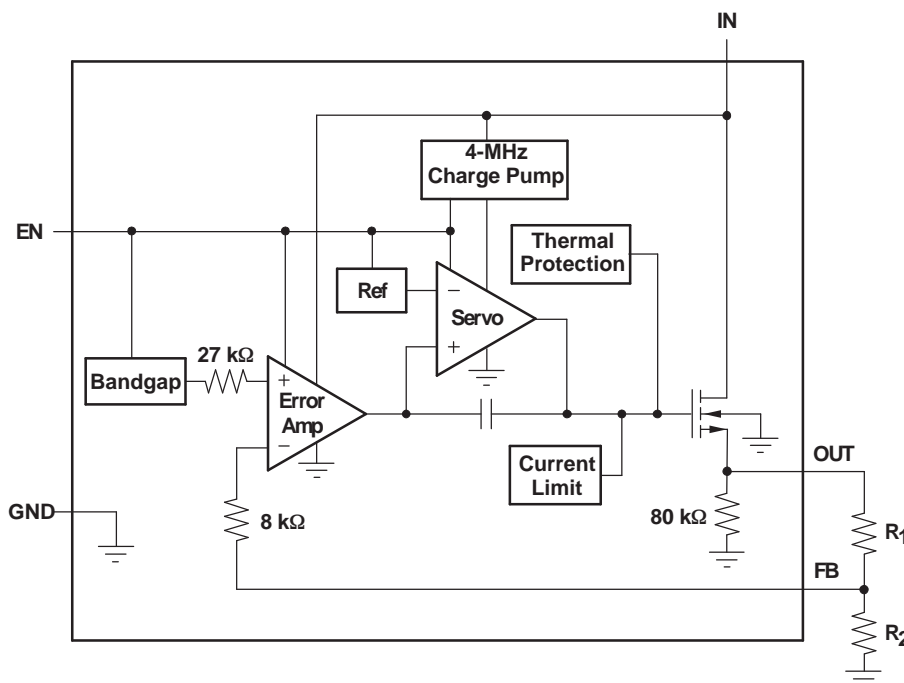

Figure 3. Adjustable-Voltage Version

Standard 1% Resistor
 Values for Common
 Output Voltages

V _O	R ₁	R ₂
1.2 V	Short	Open
1.5 V	23.2 kΩ	95.3 kΩ
1.8 V	28 kΩ	56.2 kΩ
2.5 V	39.2 kΩ	36.5 kΩ
2.8 V	44.2 kΩ	33.2 kΩ
3 V	46.4 kΩ	30.9 kΩ
3.3 V	52.3 kΩ	30.1 kΩ

NOTE: $V_{OUT} = (R_1 + R_2)/R_2 \times 1.204$;
 $R_1 || R_2 \cong 19 \text{ k}\Omega$ for best
 accuracy

TYPICAL CHARACTERISTICS

For all voltage versions, $T_J = 25^\circ\text{C}$, $V_{IN} = V_{OUT(nom)} + 0.5\text{ V}$, $I_{OUT} = 10\text{ mA}$, $V_{EN} = 1.7\text{ V}$, and $C_{OUT} = 0.1\text{ }\mu\text{F}$ (unless otherwise noted)

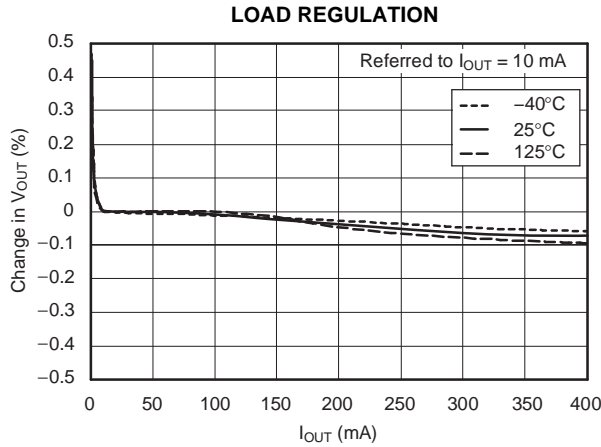

Figure 4.

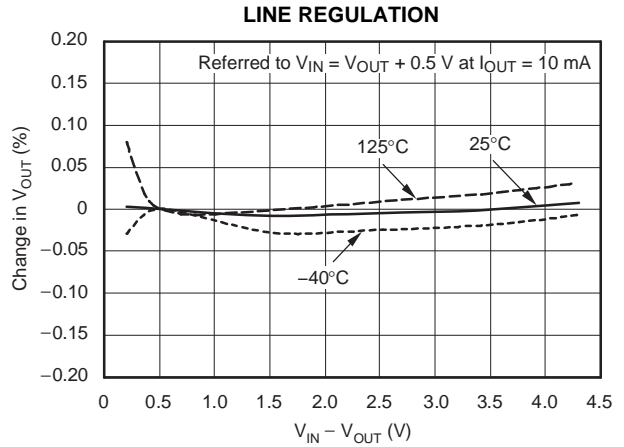

Figure 5.

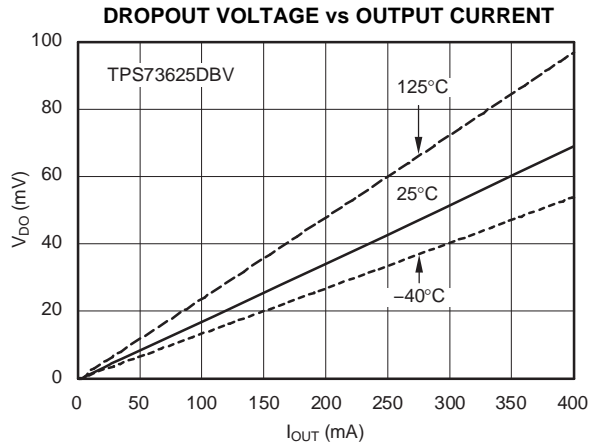

Figure 6.

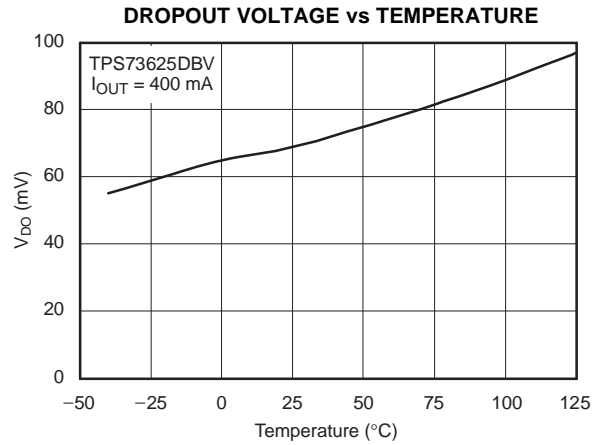

Figure 7.

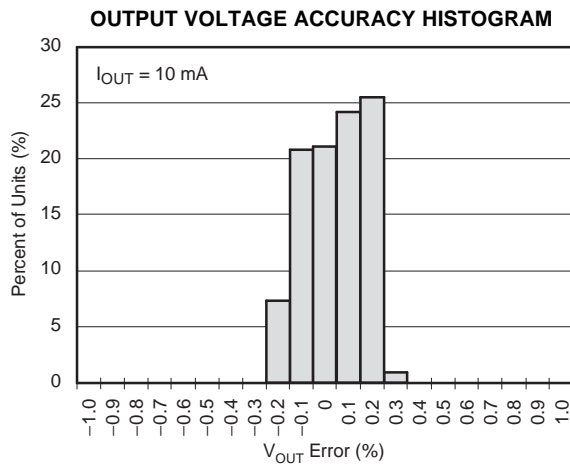

Figure 8.

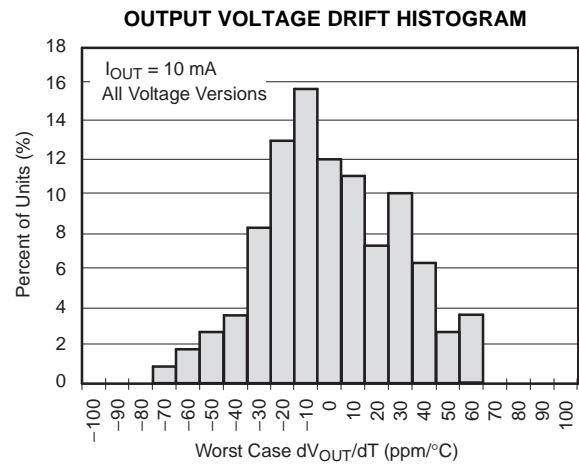

Figure 9.

TYPICAL CHARACTERISTICS (continued)

For all voltage versions, $T_J = 25^\circ\text{C}$, $V_{IN} = V_{OUT(nom)} + 0.5\text{ V}$, $I_{OUT} = 10\text{ mA}$, $V_{EN} = 1.7\text{ V}$, and $C_{OUT} = 0.1\ \mu\text{F}$
 (unless otherwise noted)

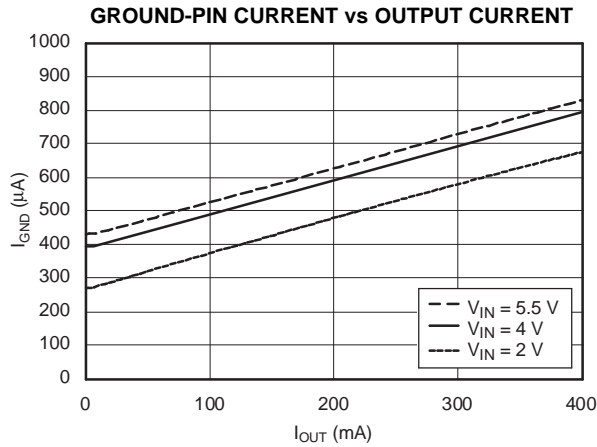

Figure 10.

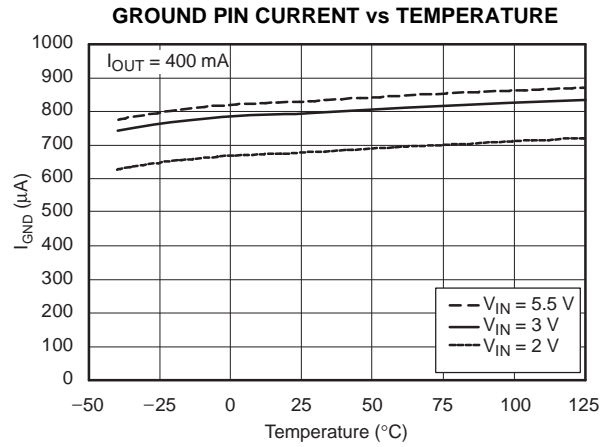

Figure 11.

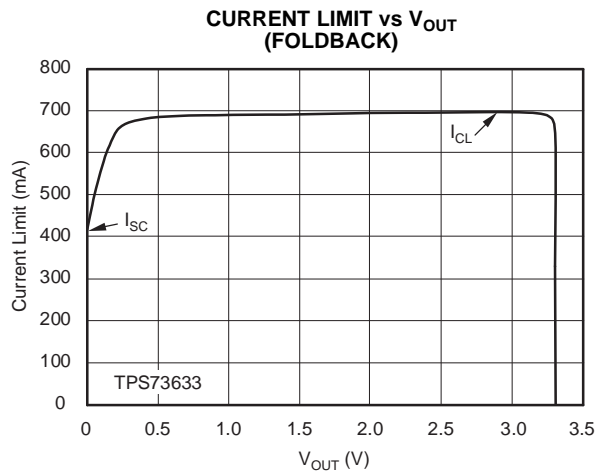

Figure 12.

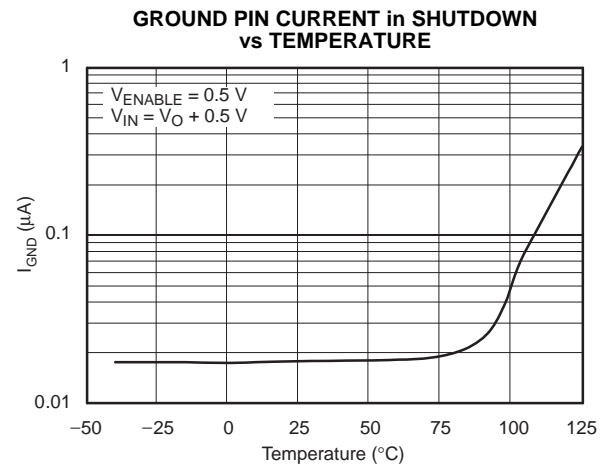

Figure 13.

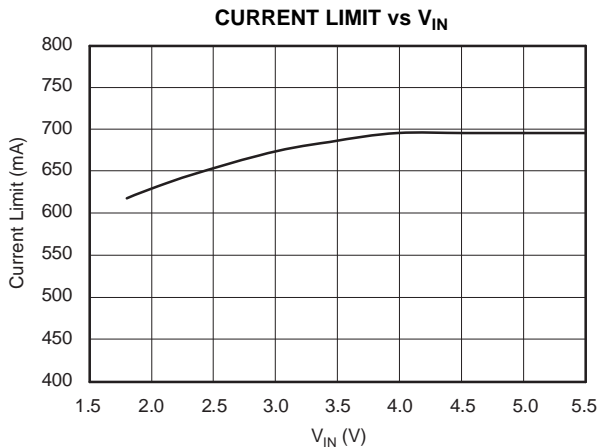

Figure 14.

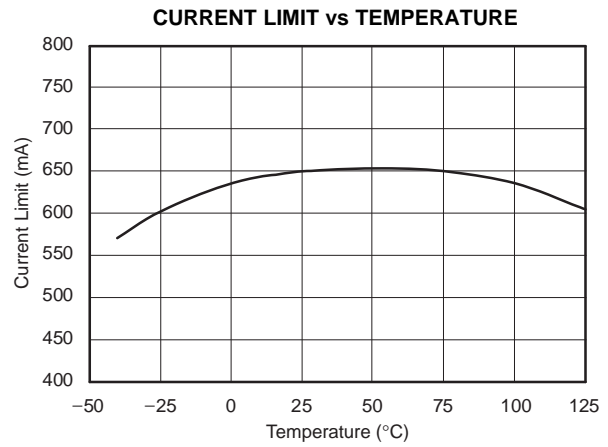

Figure 15.

TYPICAL CHARACTERISTICS (continued)

For all voltage versions, $T_J = 25^\circ\text{C}$, $V_{IN} = V_{OUT(nom)} + 0.5\text{ V}$, $I_{OUT} = 10\text{ mA}$, $V_{EN} = 1.7\text{ V}$, and $C_{OUT} = 0.1\ \mu\text{F}$ (unless otherwise noted)

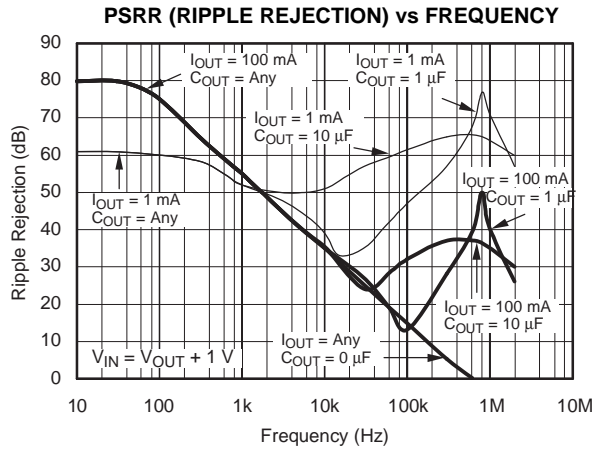

Figure 16.

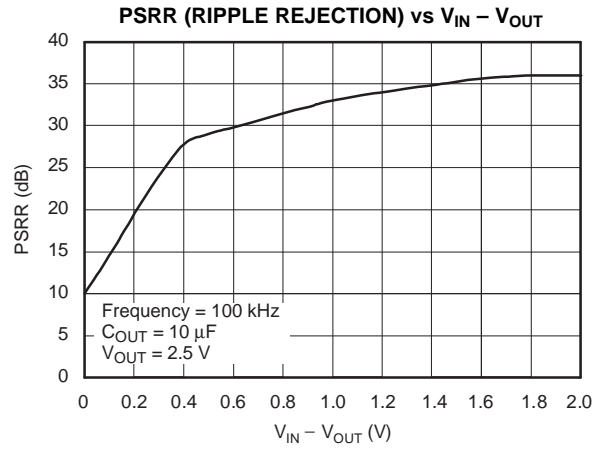

Figure 17.

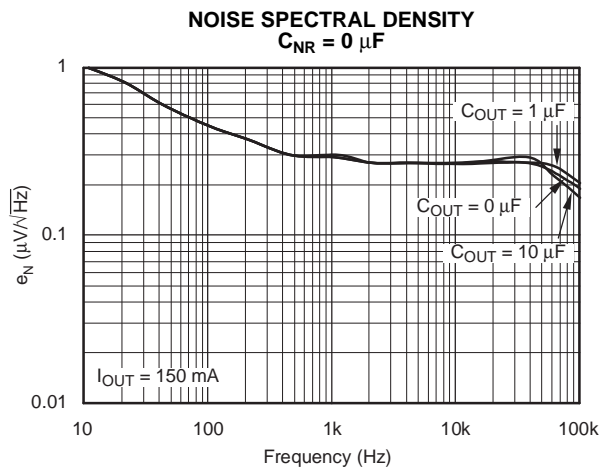

Figure 18.

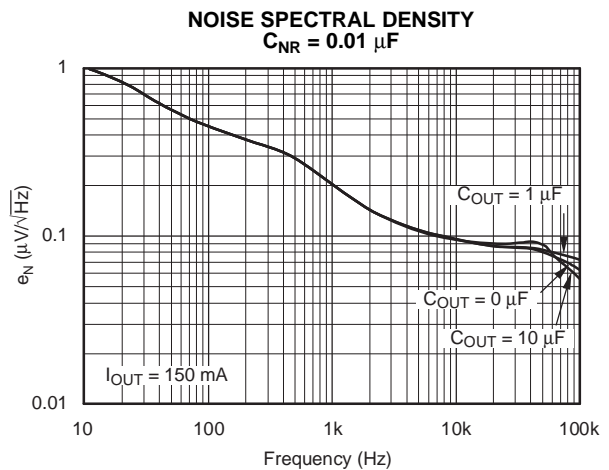

Figure 19.

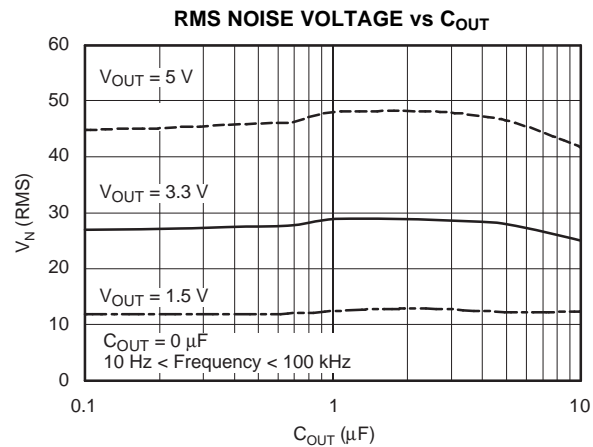

Figure 20.

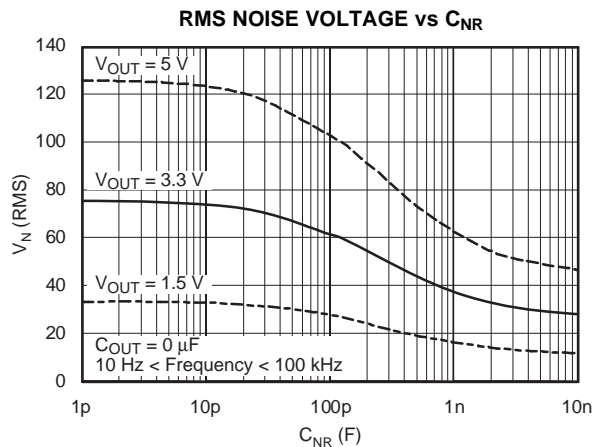

Figure 21.

TYPICAL CHARACTERISTICS (continued)

For all voltage versions, $T_J = 25^\circ\text{C}$, $V_{IN} = V_{OUT(nom)} + 0.5\text{ V}$, $I_{OUT} = 10\text{ mA}$, $V_{EN} = 1.7\text{ V}$, and $C_{OUT} = 0.1\ \mu\text{F}$ (unless otherwise noted)

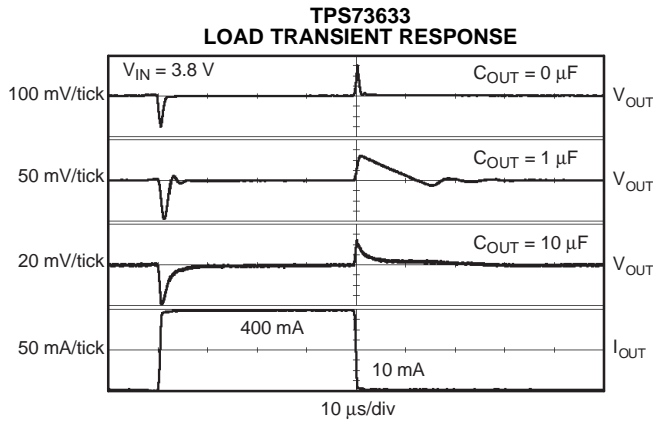

Figure 22.

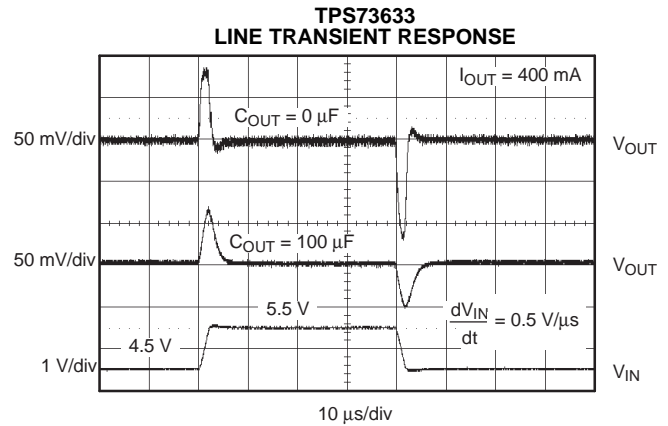

Figure 23.

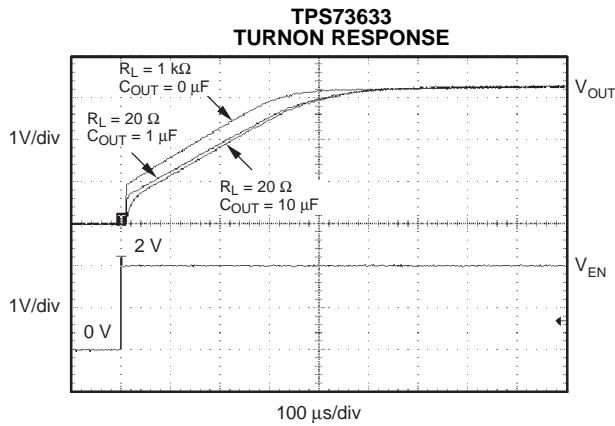

Figure 24.

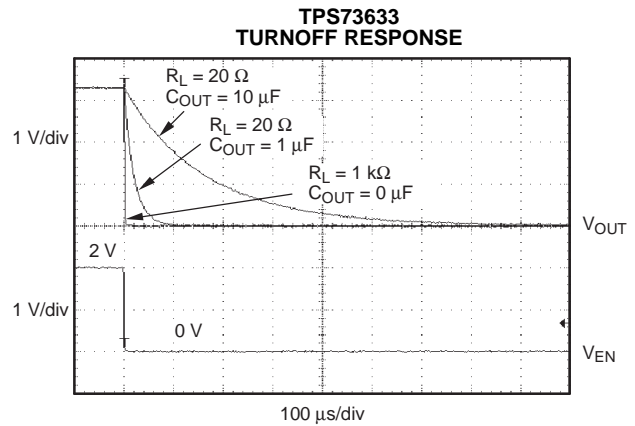

Figure 25.

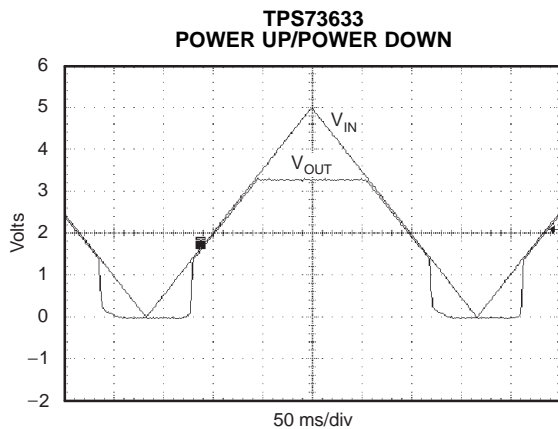

Figure 26.

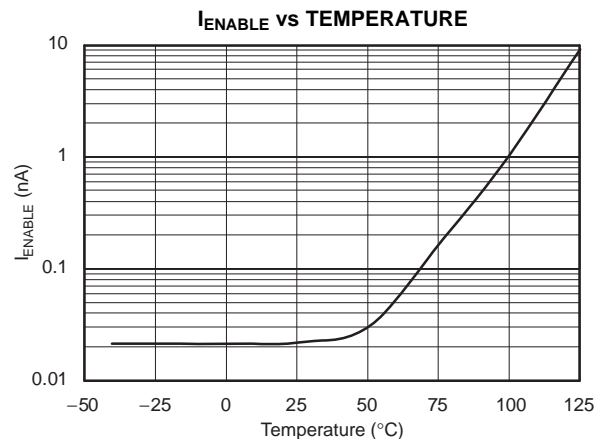

Figure 27.

TYPICAL CHARACTERISTICS (continued)

For all voltage versions, $T_J = 25^\circ\text{C}$, $V_{IN} = V_{OUT(nom)} + 0.5\text{ V}$, $I_{OUT} = 10\text{ mA}$, $V_{EN} = 1.7\text{ V}$, and $C_{OUT} = 0.1\ \mu\text{F}$ (unless otherwise noted)

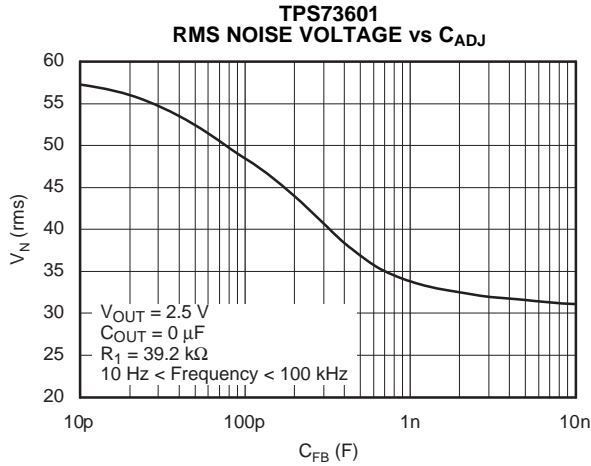

Figure 28.

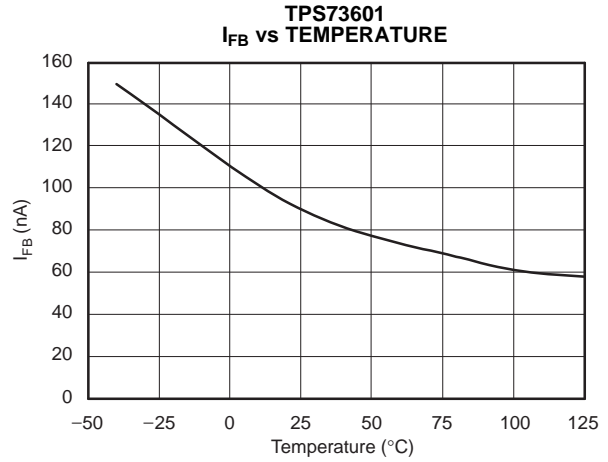

Figure 29.

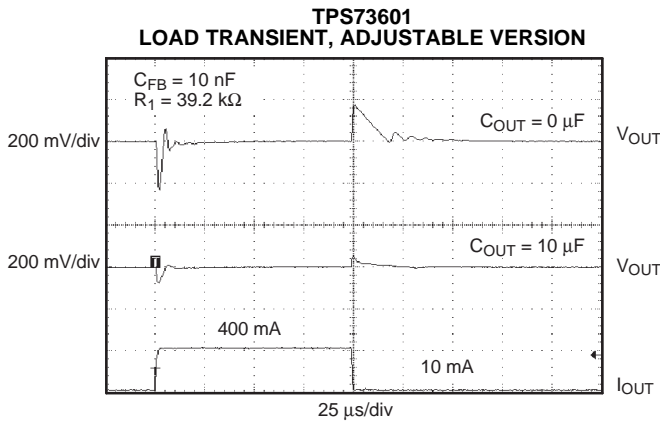

Figure 30.

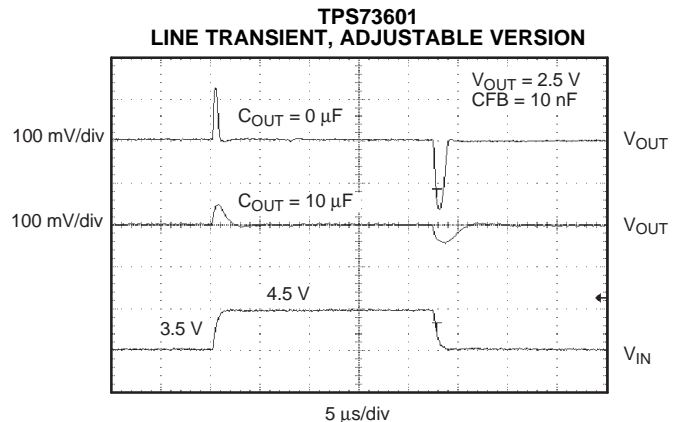

Figure 31.

APPLICATION INFORMATION

The TPS736xx belongs to a family of new-generation LDO regulators that use an NMOS pass transistor to achieve ultra-low-dropout performance, reverse current blockage, and freedom from output capacitor constraints. These features, combined with low noise and an enable input, make the TPS736xx ideal for portable applications. This regulator family offers a wide selection of fixed-output voltage versions and an adjustable-output version. All versions have thermal and overcurrent protection, including foldback current limit.

Figure 32 shows the basic circuit connections for the fixed-voltage models. Figure 33 shows the connections for the adjustable-output version (TPS73601). R_1 and R_2 can be calculated for any output voltage using the formula in Figure 33. Sample resistor values for common output voltages are shown in Figure 3. For the best accuracy, make the parallel combination of R_1 and R_2 approximately 19 k Ω .

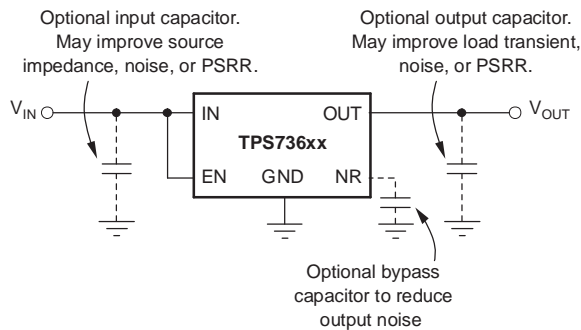

Figure 32. Typical Application Circuit for Fixed-Voltage Versions

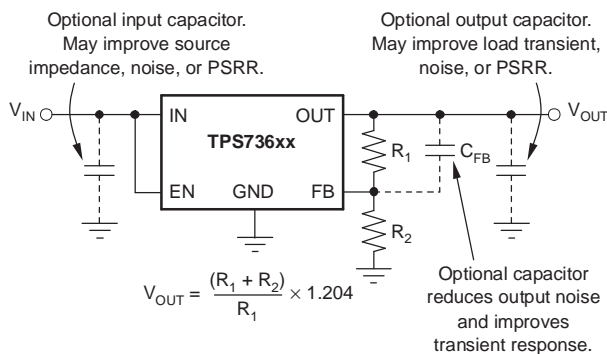

Figure 33. Typical Application Circuit for Adjustable-Voltage Versions

Input and Output Capacitor Requirements

Although an input capacitor is not required for stability, it is good analog design practice to connect a 0.1- μ F to 1- μ F low ESR capacitor across the input

supply near the regulator. This counteracts reactive input sources and improves transient response, noise rejection, and ripple rejection. A higher-value capacitor may be necessary if large, fast rise-time load transients are anticipated, or the device is located several inches from the power source.

The TPS736xx does not require an output capacitor for stability and has maximum phase margin with no capacitor. It is designed to be stable for all available types and values of capacitors. In applications where $V_{IN} - V_{OUT} < 0.5$ V and multiple low ESR capacitors are in parallel, ringing may occur when the product of C_{OUT} and total ESR drops below 50 Ω . Total ESR includes all parasitic resistance, including capacitor ESR and board, socket, and solder-joint resistance. In most applications, the sum of capacitor ESR and trace resistance meets this requirement.

Output Noise

A precision band-gap reference is used to generate the internal reference voltage, V_{REF} . This reference is the dominant noise source within the TPS736xx and it generates approximately 32 μ V_{RMS} (10 Hz to 100 kHz) at the reference output (NR). The regulator control loop gains up the reference noise with the same gain as the reference voltage, so that the noise voltage of the regulator is approximately given by:

$$V_N = 32 \mu\text{V}_{\text{RMS}} \times \frac{(R_1 + R_2)}{R_2} = 32 \mu\text{V}_{\text{RMS}} \times \frac{V_{\text{OUT}}}{V_{\text{REF}}} \quad (1)$$

Since the value of V_{REF} is 1.2 V, this relationship reduces to:

$$V_N(\mu\text{V}_{\text{RMS}}) = 27 \left(\frac{\mu\text{V}_{\text{RMS}}}{\text{V}} \right) \times V_{\text{OUT}}(\text{V}) \quad (2)$$

for the case of no C_{NR} .

An internal 27-k Ω resistor in series with the noise reduction pin (NR) forms a low-pass filter for the voltage reference when an external noise reduction capacitor, C_{NR} , is connected from NR to ground. For $C_{NR} = 10$ nF, the total noise in the 10-Hz to 100-kHz bandwidth is reduced by a factor of ~3.2, giving the approximate relationship:

$$V_N(\mu\text{V}_{\text{RMS}}) = 8.5 \left(\frac{\mu\text{V}_{\text{RMS}}}{\text{V}} \right) \times V_{\text{OUT}}(\text{V}) \quad (3)$$

for $C_{NR} = 10$ nF.

This noise reduction effect is shown as RMS Noise Voltage vs C_{NR} in Figure 21.

The TPS73601 adjustable version does not have the noise-reduction pin available. However, connecting a feedback capacitor, C_{FB} , from the output to the FB pin reduces output noise and improves load transient performance.

The TPS736xx uses an internal charge pump to develop an internal supply voltage sufficient to drive the gate of the NMOS pass element above V_{OUT} . The charge pump generates $\sim 250 \mu V$ of switching noise at ~ 4 MHz; however, charge-pump noise contribution is negligible at the output of the regulator for most values of I_{OUT} and C_{OUT} .

Board Layout Recommendation to Improve PSRR and Noise Performance

To improve ac performance such as PSRR, output noise, and transient response, it is recommended that the board be designed with separate ground planes for V_{IN} and V_{OUT} , with each ground plane connected only at the GND pin of the device. In addition, the ground connection for the bypass capacitor should connect directly to the GND pin of the device.

Internal Current Limit

The TPS736xx internal current limit helps protect the regulator during fault conditions. Foldback helps to protect the regulator from damage during output short-circuit conditions by reducing current limit when V_{OUT} drops below 0.5 V. See [Figure 12](#) for a graph of I_{OUT} vs V_{OUT} .

Shutdown

The enable (EN) pin is active high and is compatible with standard TTL-CMOS levels. V_{EN} below 0.5 V (max) turns the regulator off and drops the ground-pin current to approximately 10 nA. When shutdown capability is not required, EN can be connected to V_{IN} . When a pullup resistor is used, and operation down to 1.8 V is required, use pullup resistor values below 50 k Ω .

Dropout Voltage

The TPS736xx uses an NMOS pass transistor to achieve extremely low dropout. When $(V_{IN} - V_{OUT})$ is less than the dropout voltage (V_{DO}), the NMOS pass device is in its linear region of operation and the input-to-output resistance is the R_{DS-ON} of the NMOS pass element.

For large step changes in load current, the TPS736xx requires a larger voltage drop from V_{IN} to V_{OUT} to

avoid degraded transient response. The boundary of this transient dropout region is approximately twice the dc dropout. Values of $V_{IN} - V_{OUT}$ above this line ensure normal transient response.

Operating in the transient dropout region can cause an increase in recovery time. The time required to recover from a load transient is a function of the magnitude of the change in load current rate, the rate of change in load current, and the available headroom (V_{IN} to V_{OUT} voltage drop). Under worst-case conditions [full-scale instantaneous load change with $(V_{IN} - V_{OUT})$ close to dc dropout levels], the TPS736xx can take a couple of hundred microseconds to return to the specified regulation accuracy.

Transient Response

The low open-loop output impedance provided by the NMOS pass element in a voltage-follower configuration allows operation without an output capacitor for many applications. As with any regulator, the addition of a capacitor (nominal value 1 μF) from the output pin to ground reduces undershoot magnitude but increases duration. In the adjustable version, the addition of a capacitor, C_{FB} , from the output to the adjust pin also improves the transient response.

The TPS736xx does not have active pulldown when the output is overvoltage. This allows applications that connect higher voltage sources, such as alternate power supplies, to the output. This also results in an output overshoot of several percent if load current quickly drops to zero when a capacitor is connected to the output. The duration of overshoot can be reduced by adding a load resistor. The overshoot decays at a rate determined by output capacitor C_{OUT} and the internal/external load resistance. The rate of decay is given by:

Fixed-voltage version:

$$dV/dt = \frac{V_{OUT}}{C_{OUT} \times 80 \text{ k}\Omega \parallel R_{LOAD}} \quad (4)$$

Adjustable-voltage version:

$$dV/dt = \frac{V_{OUT}}{C_{OUT} \times 80 \text{ k}\Omega \parallel (R_1 + R_2) \parallel R_{LOAD}} \quad (5)$$

Reverse Current

The NMOS pass element of the TPS736xx provides inherent protection against current flow from the output of the regulator to the input when the gate of the pass device is pulled low. To ensure that all charge is removed from the gate of the pass element, EN must be driven low before the input voltage is removed. If this is not done, the pass element may be left on due to stored charge on the gate.

After EN is driven low, no bias voltage is needed on any pin for reverse current blocking. Note that reverse current is specified as the current flowing out of the IN pin due to voltage applied on the OUT pin. There is additional current flowing into the OUT pin due to the 80-k Ω internal resistor divider to ground (see [Figure 2](#) and [Figure 3](#)).

For the TPS73601, reverse current may flow when V_{FB} is more than 1 V above V_{IN} .

Thermal Protection

Thermal protection disables the output when the junction temperature rises to approximately 160°C, allowing the device to cool. When the junction temperature cools to approximately 140°C, the output circuitry is again enabled. Depending on power dissipation, thermal resistance, and ambient temperature, the thermal protection circuit may cycle on and off. This limits the dissipation of the regulator, protecting it from damage due to overheating.

Any tendency to activate the thermal protection circuit indicates excessive power dissipation or an inadequate heatsink. For reliable operation, junction temperature should be limited to 125°C maximum. To estimate the margin of safety in a complete design (including heatsink), increase the ambient temperature until the thermal protection is triggered; use worst-case loads and signal conditions. For good reliability, thermal protection should trigger at least

35°C above the maximum expected ambient condition of the application. This produces a worst-case junction temperature of 125°C at the highest expected ambient temperature and worst-case load.

The internal protection circuitry of the TPS736xx has been designed to protect against overload conditions. It was not intended to replace proper heatsinking. Continuously running the TPS736xx into thermal shutdown degrades reliability.

Power Dissipation

The ability to remove heat from the die is different for each package type, presenting different considerations in the PCB layout. The PCB area around the device that is free of other components moves the heat from the device to the ambient air. Performance data for JEDEC low- and high-K boards are shown in the *Power Dissipation Ratings* table. Using heavier copper increases the effectiveness in removing heat from the device. The addition of plated through-holes to heat-dissipating layers also improves the heatsink effectiveness.

Power dissipation depends on input voltage and load conditions. Power dissipation is equal to the product of the output current times the voltage drop across the output pass element (V_{IN} to V_{OUT}):

$$P_D = (V_{IN} - V_{OUT}) \times I_{OUT} \quad (6)$$



Power dissipation can be minimized by using the lowest-possible input voltage necessary to ensure the required output voltage.

Package Mounting

Solder-pad footprint recommendations for the TPS736xx are presented in application bulletin *Solder Pad Recommendations for Surface-Mount Devices* (AB-132), available from the TI web site at www.ti.com.

PACKAGING INFORMATION

Orderable Device	Status (1)	Package Type	Package Drawing	Pins	Package Qty	Eco Plan (2)	Lead/Ball Finish (6)	MSL Peak Temp (3)	Op Temp (°C)	Device Marking (4/5)	Samples
TPS73601MDBVREP	ACTIVE	SOT-23	DBV	5	3000	Green (RoHS & no Sb/Br)	CU NIPDAU	Level-1-260C-UNLIM	-55 to 125	PJRM	Samples
TPS73601MDCQREP	ACTIVE	SOT-223	DCQ	6	2500	Green (RoHS & no Sb/Br)	CU NIPDAU	Level-2-260C-1 YEAR	-55 to 125	PWZM	Samples
TPS73601MDRBREP	ACTIVE	SON	DRB	8	3000	Green (RoHS & no Sb/Br)	CU NIPDAU	Level-2-260C-1 YEAR	-55 to 125	PMNM	Samples
TPS73615MDBVREP	ACTIVE	SOT-23	DBV	5	3000	Green (RoHS & no Sb/Br)	CU NIPDAU	Level-1-260C-UNLIM	-55 to 125	T59	Samples
TPS73618MDBVREP	ACTIVE	SOT-23	DBV	5	3000	Green (RoHS & no Sb/Br)	CU NIPDAU	Level-1-260C-UNLIM	-55 to 125	T60	Samples
TPS73625MDBVREP	ACTIVE	SOT-23	DBV	5	3000	Green (RoHS & no Sb/Br)	CU NIPDAU	Level-1-260C-UNLIM	-55 to 125	T61	Samples
TPS73630MDBVREP	ACTIVE	SOT-23	DBV	5	3000	Green (RoHS & no Sb/Br)	CU NIPDAU	Level-1-260C-UNLIM	-55 to 125	T62	Samples
TPS73632MDBVREP	ACTIVE	SOT-23	DBV	5	3000	Green (RoHS & no Sb/Br)	CU NIPDAU	Level-1-260C-UNLIM	-55 to 125	T63	Samples
TPS73633MDBVREP	ACTIVE	SOT-23	DBV	5	3000	Green (RoHS & no Sb/Br)	CU NIPDAU	Level-1-260C-UNLIM	-55 to 125	T64	Samples
TPS73633MDBVREPG4	ACTIVE	SOT-23	DBV	5	3000	Green (RoHS & no Sb/Br)	CU NIPDAU	Level-1-260C-UNLIM	-55 to 125	T64	Samples
V62/06626-01XE	ACTIVE	SOT-23	DBV	5	3000	Green (RoHS & no Sb/Br)	CU NIPDAU	Level-1-260C-UNLIM	-55 to 125	PJRM	Samples
V62/06626-01YE	ACTIVE	SOT-223	DCQ	6	2500	Green (RoHS & no Sb/Br)	CU NIPDAU	Level-2-260C-1 YEAR	-55 to 125	PWZM	Samples
V62/06626-01ZE	ACTIVE	SON	DRB	8	3000	Green (RoHS & no Sb/Br)	CU NIPDAU	Level-2-260C-1 YEAR	-55 to 125	PMNM	Samples
V62/06626-02XE	ACTIVE	SOT-23	DBV	5	3000	Green (RoHS & no Sb/Br)	CU NIPDAU	Level-1-260C-UNLIM	-55 to 125	T59	Samples
V62/06626-03XE	ACTIVE	SOT-23	DBV	5	3000	Green (RoHS & no Sb/Br)	CU NIPDAU	Level-1-260C-UNLIM	-55 to 125	T60	Samples
V62/06626-04XE	ACTIVE	SOT-23	DBV	5	3000	Green (RoHS & no Sb/Br)	CU NIPDAU	Level-1-260C-UNLIM	-55 to 125	T61	Samples
V62/06626-05XE	ACTIVE	SOT-23	DBV	5	3000	Green (RoHS & no Sb/Br)	CU NIPDAU	Level-1-260C-UNLIM	-55 to 125	T62	Samples

Orderable Device	Status (1)	Package Type	Package Drawing	Pins	Package Qty	Eco Plan (2)	Lead/Ball Finish (6)	MSL Peak Temp (3)	Op Temp (°C)	Device Marking (4/5)	Samples
V62/06626-06XE	ACTIVE	SOT-23	DBV	5	3000	Green (RoHS & no Sb/Br)	CU NIPDAU	Level-1-260C-UNLIM	-55 to 125	T63	
V62/06626-07XE	ACTIVE	SOT-23	DBV	5	3000	Green (RoHS & no Sb/Br)	CU NIPDAU	Level-1-260C-UNLIM	-55 to 125	T64	

(1) The marketing status values are defined as follows:

ACTIVE: Product device recommended for new designs.

LIFEBUY: TI has announced that the device will be discontinued, and a lifetime-buy period is in effect.

NRND: Not recommended for new designs. Device is in production to support existing customers, but TI does not recommend using this part in a new design.

PREVIEW: Device has been announced but is not in production. Samples may or may not be available.

OBSOLETE: TI has discontinued the production of the device.

(2) Eco Plan - The planned eco-friendly classification: Pb-Free (RoHS), Pb-Free (RoHS Exempt), or Green (RoHS & no Sb/Br) - please check <http://www.ti.com/productcontent> for the latest availability information and additional product content details.

TBD: The Pb-Free/Green conversion plan has not been defined.

Pb-Free (RoHS): TI's terms "Lead-Free" or "Pb-Free" mean semiconductor products that are compatible with the current RoHS requirements for all 6 substances, including the requirement that lead not exceed 0.1% by weight in homogeneous materials. Where designed to be soldered at high temperatures, TI Pb-Free products are suitable for use in specified lead-free processes.

Pb-Free (RoHS Exempt): This component has a RoHS exemption for either 1) lead-based flip-chip solder bumps used between the die and package, or 2) lead-based die adhesive used between the die and leadframe. The component is otherwise considered Pb-Free (RoHS compatible) as defined above.

Green (RoHS & no Sb/Br): TI defines "Green" to mean Pb-Free (RoHS compatible), and free of Bromine (Br) and Antimony (Sb) based flame retardants (Br or Sb do not exceed 0.1% by weight in homogeneous material)

(3) MSL, Peak Temp. - The Moisture Sensitivity Level rating according to the JEDEC industry standard classifications, and peak solder temperature.

(4) There may be additional marking, which relates to the logo, the lot trace code information, or the environmental category on the device.

(5) Multiple Device Markings will be inside parentheses. Only one Device Marking contained in parentheses and separated by a "~" will appear on a device. If a line is indented then it is a continuation of the previous line and the two combined represent the entire Device Marking for that device.

(6) Lead/Ball Finish - Orderable Devices may have multiple material finish options. Finish options are separated by a vertical ruled line. Lead/Ball Finish values may wrap to two lines if the finish value exceeds the maximum column width.

Important Information and Disclaimer: The information provided on this page represents TI's knowledge and belief as of the date that it is provided. TI bases its knowledge and belief on information provided by third parties, and makes no representation or warranty as to the accuracy of such information. Efforts are underway to better integrate information from third parties. TI has taken and continues to take reasonable steps to provide representative and accurate information but may not have conducted destructive testing or chemical analysis on incoming materials and chemicals. TI and TI suppliers consider certain information to be proprietary, and thus CAS numbers and other limited information may not be available for release.

In no event shall TI's liability arising out of such information exceed the total purchase price of the TI part(s) at issue in this document sold by TI to Customer on an annual basis.

OTHER QUALIFIED VERSIONS OF TPS73601-EP, TPS73615-EP, TPS73618-EP, TPS73625-EP, TPS73630-EP, TPS73632-EP, TPS73633-EP :

- Catalog: [TPS73601](#), [TPS73615](#), [TPS73618](#), [TPS73625](#), [TPS73630](#), [TPS73632](#), [TPS73633](#)

- Automotive: [TPS73601-Q1](#), [TPS73618-Q1](#)

NOTE: Qualified Version Definitions:

- Catalog - TI's standard catalog product
- Automotive - Q100 devices qualified for high-reliability automotive applications targeting zero defects

TAPE AND REEL INFORMATION

QUADRANT ASSIGNMENTS FOR PIN 1 ORIENTATION IN TAPE

*All dimensions are nominal

Device	Package Type	Package Drawing	Pins	SPQ	Reel Diameter (mm)	Reel Width W1 (mm)	A0 (mm)	B0 (mm)	K0 (mm)	P1 (mm)	W (mm)	Pin1 Quadrant
TPS73601MDBVREP	SOT-23	DBV	5	3000	179.0	8.4	3.2	3.2	1.4	4.0	8.0	Q3
TPS73601MDCQREP	SOT-223	DCQ	6	2500	330.0	12.4	7.1	7.45	1.88	8.0	12.0	Q3
TPS73601MDRBREP	SON	DRB	8	3000	330.0	12.4	3.3	3.3	1.0	8.0	12.0	Q2
TPS73615MDBVREP	SOT-23	DBV	5	3000	179.0	8.4	3.2	3.2	1.4	4.0	8.0	Q3
TPS73618MDBVREP	SOT-23	DBV	5	3000	179.0	8.4	3.2	3.2	1.4	4.0	8.0	Q3
TPS73625MDBVREP	SOT-23	DBV	5	3000	179.0	8.4	3.2	3.2	1.4	4.0	8.0	Q3
TPS73630MDBVREP	SOT-23	DBV	5	3000	179.0	8.4	3.2	3.2	1.4	4.0	8.0	Q3
TPS73632MDBVREP	SOT-23	DBV	5	3000	179.0	8.4	3.2	3.2	1.4	4.0	8.0	Q3
TPS73633MDBVREP	SOT-23	DBV	5	3000	179.0	8.4	3.2	3.2	1.4	4.0	8.0	Q3

TAPE AND REEL BOX DIMENSIONS

*All dimensions are nominal

Device	Package Type	Package Drawing	Pins	SPQ	Length (mm)	Width (mm)	Height (mm)
TPS73601MDBVREP	SOT-23	DBV	5	3000	203.0	203.0	35.0
TPS73601MDCQREP	SOT-223	DCQ	6	2500	346.0	346.0	41.0
TPS73601MDRBREP	SON	DRB	8	3000	370.0	355.0	55.0
TPS73615MDBVREP	SOT-23	DBV	5	3000	203.0	203.0	35.0
TPS73618MDBVREP	SOT-23	DBV	5	3000	203.0	203.0	35.0
TPS73625MDBVREP	SOT-23	DBV	5	3000	203.0	203.0	35.0
TPS73630MDBVREP	SOT-23	DBV	5	3000	203.0	203.0	35.0
TPS73632MDBVREP	SOT-23	DBV	5	3000	203.0	203.0	35.0
TPS73633MDBVREP	SOT-23	DBV	5	3000	203.0	203.0	35.0

DCQ (R-PDSO-G6)

PLASTIC SMALL-OUTLINE

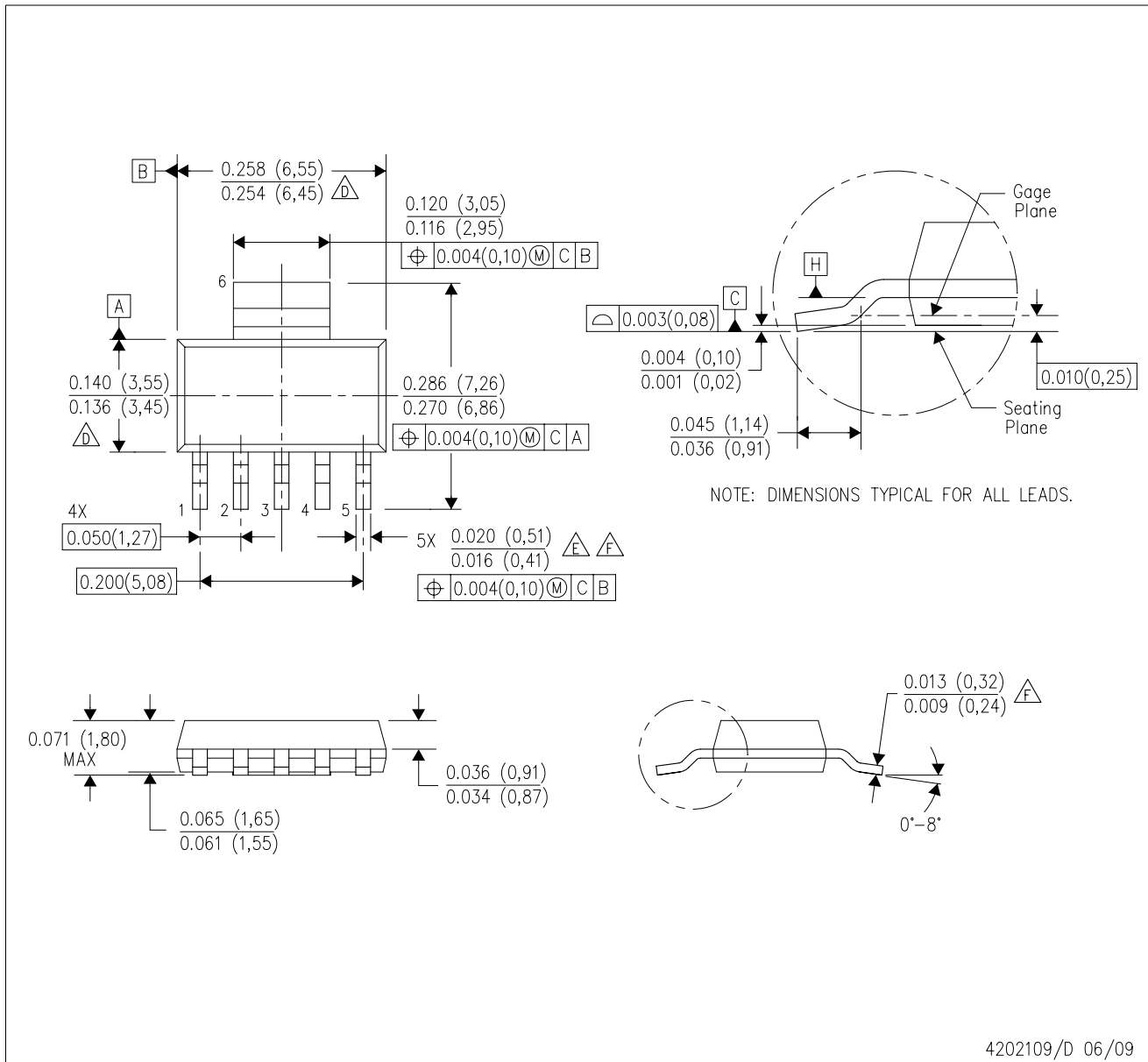

- NOTES:
- A. All linear dimensions are in inches (millimeters).
 - B. This drawing is subject to change without notice.
 - C. Controlling dimension in inches.
 - $\triangle D$ Body length and width dimensions are determined at the outermost extremes of the plastic body exclusive of mold flash, tie bar burrs, gate burrs, and interlead flash, but including any mismatch between the top and the bottom of the plastic body.
 - $\triangle E$ Lead width dimension does not include dambar protrusion.
 - $\triangle F$ Lead width and thickness dimensions apply to solder plated leads.
 - G. Interlead flash allow 0.008 inch max.
 - H. Gate burr/protrusion max. 0.006 inch.
 - I. Datums A and B are to be determined at Datum H.

DCQ (R-PDSO-G6)

PLASTIC SMALL OUTLINE

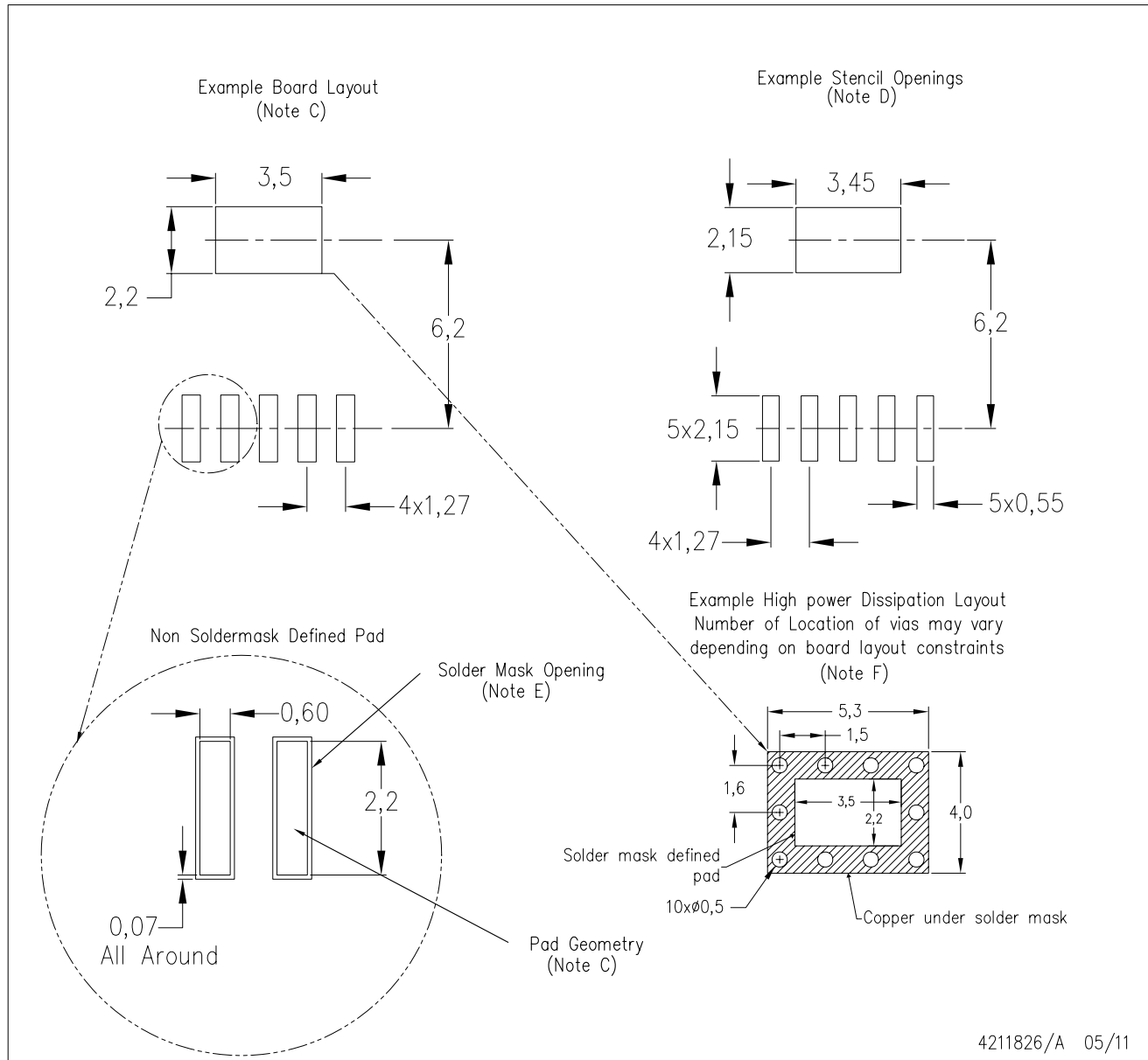

- NOTES:
- All linear dimensions are in millimeters.
 - This drawing is subject to change without notice.
 - Publication IPC-SM-782 is recommended for alternate designs.
 - Laser cutting apertures with trapezoidal walls and also rounding corners will offer better paste release. Customers should contact their board assembly site for stencil design recommendations.
 - Customers should contact their board fabrication site for solder mask tolerances between and around signal pads.
 - Please refer to the product data sheet for specific via and thermal dissipation requirements.

DRB 8

GENERIC PACKAGE VIEW

VSON - 1 mm max height

PLASTIC SMALL OUTLINE - NO LEAD

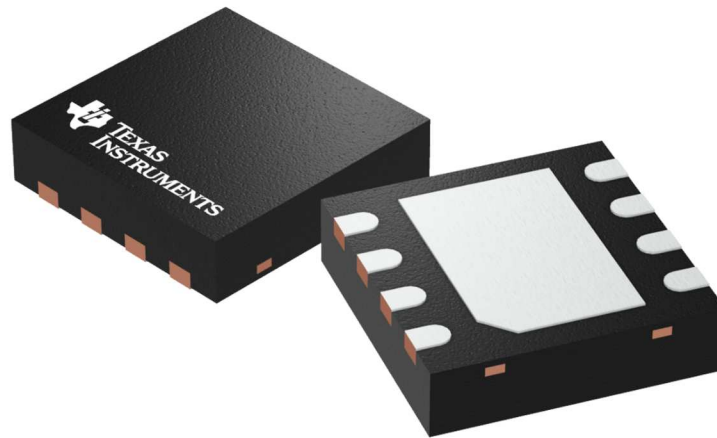

Images above are just a representation of the package family, actual package may vary.
Refer to the product data sheet for package details.

4203482/L

EXAMPLE BOARD LAYOUT

DRB0008A

VSON - 1 mm max height

PLASTIC SMALL OUTLINE - NO LEAD

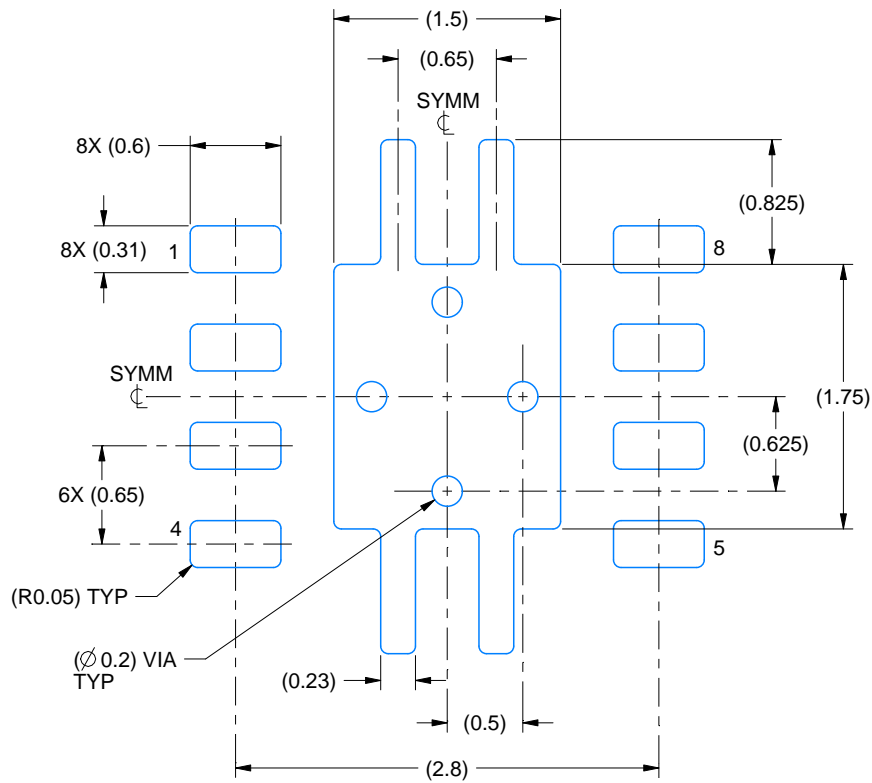

LAND PATTERN EXAMPLE
EXPOSED METAL SHOWN
SCALE:20X

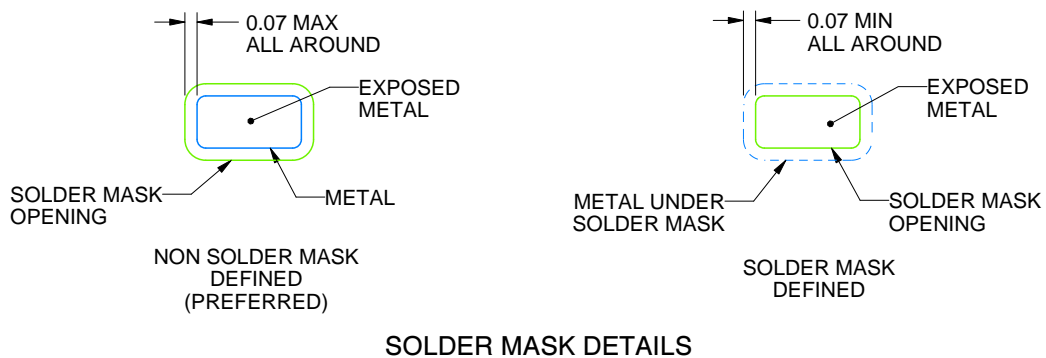

SOLDER MASK DETAILS

4218875/A 01/2018

NOTES: (continued)

4. This package is designed to be soldered to a thermal pad on the board. For more information, see Texas Instruments literature number SLUA271 (www.ti.com/lit/sluea271).
5. Vias are optional depending on application, refer to device data sheet. If any vias are implemented, refer to their locations shown on this view. It is recommended that vias under paste be filled, plugged or tented.

EXAMPLE STENCIL DESIGN

DRB0008A

VSON - 1 mm max height

PLASTIC SMALL OUTLINE - NO LEAD

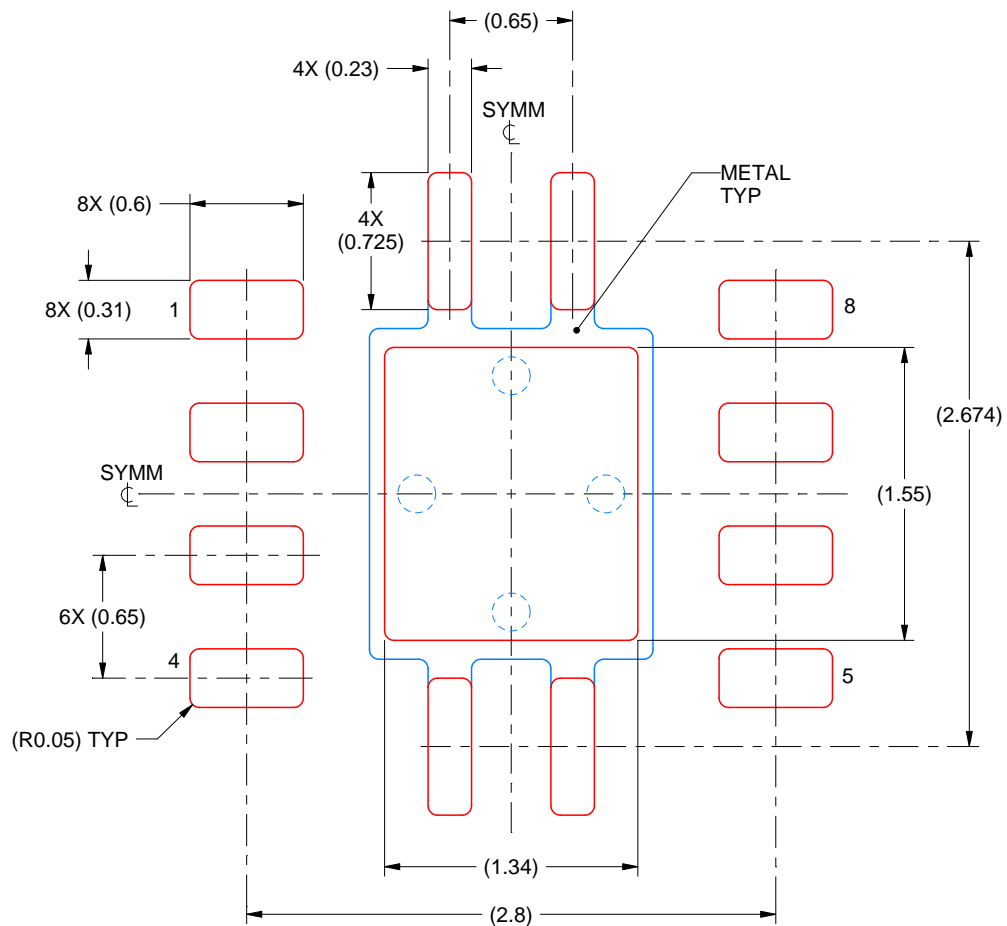

SOLDER PASTE EXAMPLE
BASED ON 0.125 mm THICK STENCIL

EXPOSED PAD
84% PRINTED SOLDER COVERAGE BY AREA
SCALE:25X

4218875/A 01/2018

NOTES: (continued)

6. Laser cutting apertures with trapezoidal walls and rounded corners may offer better paste release. IPC-7525 may have alternate design recommendations.

DBV0005A



PACKAGE OUTLINE

SOT-23 - 1.45 mm max height

SMALL OUTLINE TRANSISTOR



4214839/D 11/2018

NOTES:

1. All linear dimensions are in millimeters. Any dimensions in parenthesis are for reference only. Dimensioning and tolerancing per ASME Y14.5M.
2. This drawing is subject to change without notice.
3. Reference JEDEC MO-178.
4. Body dimensions do not include mold flash, protrusions, or gate burrs. Mold flash, protrusions, or gate burrs shall not exceed 0.15 mm per side.

EXAMPLE BOARD LAYOUT

DBV0005A

SOT-23 - 1.45 mm max height

SMALL OUTLINE TRANSISTOR



LAND PATTERN EXAMPLE
EXPOSED METAL SHOWN
SCALE:15X

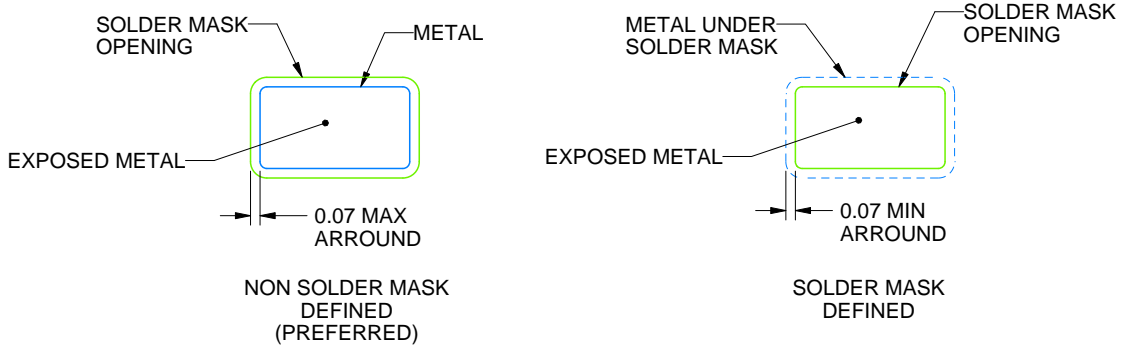

SOLDER MASK DETAILS

4214839/D 11/2018

NOTES: (continued)

- 5. Publication IPC-7351 may have alternate designs.
- 6. Solder mask tolerances between and around signal pads can vary based on board fabrication site.

EXAMPLE STENCIL DESIGN

DBV0005A

SOT-23 - 1.45 mm max height

SMALL OUTLINE TRANSISTOR



SOLDER PASTE EXAMPLE
BASED ON 0.125 mm THICK STENCIL
SCALE:15X

4214839/D 11/2018

NOTES: (continued)

7. Laser cutting apertures with trapezoidal walls and rounded corners may offer better paste release. IPC-7525 may have alternate design recommendations.
8. Board assembly site may have different recommendations for stencil design.

IMPORTANT NOTICE AND DISCLAIMER

TI PROVIDES TECHNICAL AND RELIABILITY DATA (INCLUDING DATASHEETS), DESIGN RESOURCES (INCLUDING REFERENCE DESIGNS), APPLICATION OR OTHER DESIGN ADVICE, WEB TOOLS, SAFETY INFORMATION, AND OTHER RESOURCES "AS IS" AND WITH ALL FAULTS, AND DISCLAIMS ALL WARRANTIES, EXPRESS AND IMPLIED, INCLUDING WITHOUT LIMITATION ANY IMPLIED WARRANTIES OF MERCHANTABILITY, FITNESS FOR A PARTICULAR PURPOSE OR NON-INFRINGEMENT OF THIRD PARTY INTELLECTUAL PROPERTY RIGHTS.

These resources are intended for skilled developers designing with TI products. You are solely responsible for (1) selecting the appropriate TI products for your application, (2) designing, validating and testing your application, and (3) ensuring your application meets applicable standards, and any other safety, security, or other requirements. These resources are subject to change without notice. TI grants you permission to use these resources only for development of an application that uses the TI products described in the resource. Other reproduction and display of these resources is prohibited. No license is granted to any other TI intellectual property right or to any third party intellectual property right. TI disclaims responsibility for, and you will fully indemnify TI and its representatives against, any claims, damages, costs, losses, and liabilities arising out of your use of these resources.

TI's products are provided subject to TI's Terms of Sale (www.ti.com/legal/termsofsale.html) or other applicable terms available either on ti.com or provided in conjunction with such TI products. TI's provision of these resources does not expand or otherwise alter TI's applicable warranties or warranty disclaimers for TI products.

Mailing Address: Texas Instruments, Post Office Box 655303, Dallas, Texas 75265
Copyright © 2019, Texas Instruments Incorporated

Looking for pricing, stock, or lifecycle information?

Click below to explore more details on WIN SOURCE:

 [View TPS73633MDBVREP on WIN SOURCE](#)

 [Texas Instruments](#) Information

Optimize Your Supply Chain with WIN SOURCE Solutions

-  Global Sourcing Solution
-  Obsolete Management
-  Cost Control Management
-  Shortage Management
-  Alternative Solution
-  Excess Inventory Management