



**THE DATASHEET OF
TPS74401KTWR**



TPS74401 3.0-A, Ultra-LDO with Programmable Soft-Start

1 Features

- Input Voltage Range: 1.1 V to 5.5 V
- Soft-Start (SS) Pin Provides a Linear Startup With Ramp Time Set by External Capacitor
- 1% Accuracy Over Line, Load, and Temperature
- Supports Input Voltages as Low as 0.9 V With External Bias Supply
- Adjustable Output: 0.8 V to 3.6 V
- Ultra-Low Dropout: 115 mV at 3.0 A (typical)
- Stable With Any or No Output Capacitor
- Excellent Transient Response
- Open-Drain Power-Good (VQFN Only)
- Packages: 5-mm × 5-mm × 1-mm VQFN (RGW), 3.5-mm × 3.5-mm VQFN (RGR), and DDPACK

2 Applications

- FPGA Applications
- DSP Core and I/O Voltages
- Post-Regulation Applications
- Applications With Special Start-Up Time or Sequencing Requirements
- Hot-Swap and Inrush Controls

3 Description

The TPS74401 low-dropout (LDO) linear regulators provide an easy-to-use robust power-management solution for a wide variety of applications. The user-programmable soft-start minimizes stress on the input power source by reducing capacitive inrush current on start-up. The soft-start is monotonic and well-suited for powering many different types of processors and application-specific integrated circuits (ASICs). The enable input and power-good output allow easy sequencing with external regulators. This complete flexibility lets the user configure a solution that meets the sequencing requirements of field-programmable gate arrays (FPGAs), digital signal processors (DSPs), and other applications with specific start-up requirements.

A precision reference and error amplifier deliver 1% accuracy over load, line, temperature, and process. The TPS74401 family of LDOs is stable without an output capacitor or with ceramic output capacitors. The device family is fully specified from $T_J = -40^{\circ}\text{C}$ to 125°C . The TPS74401 is offered in two 20-pin small VQFN packages (a 5-mm × 5-mm RGW and a 3.5-mm × 3.5-mm RGR package), yielding a highly compact total solution size. For applications that require additional power dissipation, the DDPACK (KTW) package is also available.

Device Information⁽¹⁾

PART NUMBER	PACKAGE	BODY SIZE (NOM)
TPS74401	TO-263 (7)	10.10 mm × 8.89 mm
	VQFN, RGW (20)	5.00 mm × 5.00 mm
	VQFN, RGR (20)	3.50 mm × 3.50 mm

(1) For all available packages, see the orderable addendum at the end of the datasheet.

Typical Application Circuit

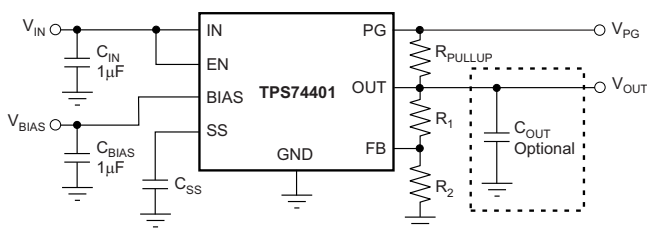

$$R_1 = \left[\frac{V_{OUT}}{V_{REF}} - 1 \right] \times R_2$$

Turn-On Response

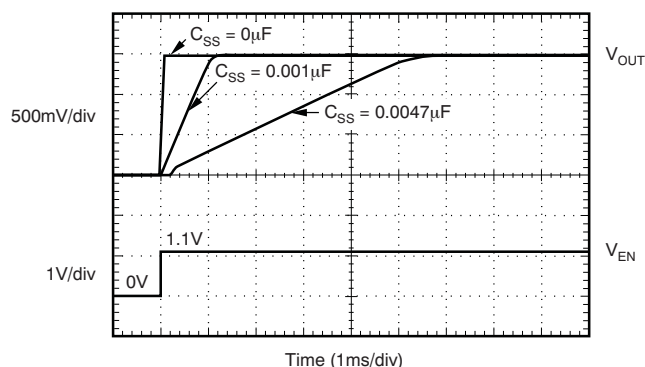

Table of Contents

1 Features	1	8 Application and Implementation	18
2 Applications	1	8.1 Application Information.....	18
3 Description	1	8.2 Typical Applications	20
4 Revision History	2	9 Power Supply Recommendations	24
5 Pin Configuration and Functions	5	10 Layout	25
6 Specifications	6	10.1 Layout Guidelines	25
6.1 Absolute Maximum Ratings	6	10.2 Layout Example	25
6.2 ESD Ratings	6	10.3 Power Dissipation	25
6.3 Recommended Operating Conditions.....	6	10.4 Thermal Considerations.....	26
6.4 Thermal Information	7	11 Device and Documentation Support	29
6.5 Electrical Characteristics.....	7	11.1 Device Support.....	29
6.6 Timing Requirements.....	8	11.2 Documentation Support	29
6.7 Typical Characteristics.....	9	11.3 Receiving Notification of Documentation Updates	29
7 Detailed Description	14	11.4 Community Resources.....	29
7.1 Overview	14	11.5 Trademarks	29
7.2 Functional Block Diagram	14	11.6 Electrostatic Discharge Caution.....	29
7.3 Feature Description.....	14	11.7 Glossary	29
7.4 Device Functional Modes.....	15	12 Mechanical, Packaging, and Orderable	
7.5 Programming	16	Information	30

4 Revision History

NOTE: Page numbers for previous revisions may differ from page numbers in the current version.

Changes from Revision Q (April 2015) to Revision R	Page
• Added RGR package to document	1
• Changed TPS744xx to TPS74401 throughout document	1
• Changed <i>Packages</i> Features bullet	1
• Changed second paragraph of Description section: added RGR package and changed second to last sentence.....	1
• Deleted fixed voltage version of <i>Typical Application Circuit</i> diagram.....	1
• Added RGR package to <i>Pin Configuration and Functions</i> section	5
• Changed FB/SNS to FB in both pin out drawings, deleted TPS744xx from VQFN package	5
• Changed <i>Surface Mount</i> to <i>Top View</i> in KTW pin out drawing.....	5
• Changed <i>input capacitor</i> to <i>bias capacitor</i> in BIAS pin description	5
• Deleted (<i>adjustable version only</i>) from description of FB pin in <i>Pin Functions</i> table	5
• Changed I/O column value to — from O for NC pins of <i>Pin Functions</i> table	5
• Deleted SNS pin from <i>Pin Functions</i> table	5
• Added RGR package to <i>Thermal Information</i> table	7
• Deleted (<i>adjustable version</i>) from V_{REF} parameter name in <i>Electrical Characteristics</i> table	7
• Deleted SNS pin reference from I_{FB} , I_{SNS} parameter: changed symbol from I_{FB} , I_{SNS} to I_{FB} , deleted <i>sense</i> from parameter name	7
• Deleted <i>adjustable</i> from footnote 1 and deleted I_{SNS} from footnote 4 of <i>Electrical Characteristics</i> table	7
• Changed conditions of R_1 , R_2 in <i>Noise Spectral Density</i> figure	11
• Deleted <i>Fixed Voltage Versions</i> figure from <i>Functional Block Diagram</i> section	14
• Changed first paragraph of <i>Application Information</i> section: deleted <i>and tracking capabilities</i> from first sentence and changed <i>very low input and output voltages</i> to <i>very low output voltages with low V_{IN} to V_{OUT} headroom</i> in last sentence	18
• Changed title of first typical application from <i>Adjustable Voltage Part and Setting</i> to <i>Setting the TPS74401</i>	20
• Deleted reference to adjustable version in first sentence and <i>Typical Application Circuit for the TPS74401</i> figure in first typical application section.....	20
• Changed <i>Because $V_{IN} \geq V_{OUT} + 1.62 V$</i> to <i>Because V_{IN} is less than V_{OUT} plus the V_{BIAS} dropout and $V_{BIAS} = V_{IN}$</i> to	

Revision History (continued)

$V_{BIAS} = V_{OUT}$ in last paragraph of <i>Detailed Design Procedure</i> in first typical application section	21
• Deleted <i>Fixed Voltage and Sense Pin</i> section	23
• Deleted BIAS recommendation from <i>Layout Guidelines</i> section.....	25
• Changed <i>RGW Package</i> to <i>VQFN Packages</i> in caption of <i>Layout Schematic</i> figure.....	25
• Added RGR package to VQFN description in <i>Power Dissipation</i> section.....	26
• Added RGR package to <i>Thermal Considerations</i> section	27

Changes from Revision P (January 2015) to Revision Q
Page

• Changed QFN to VQFN throughout document	1
• Changed TPS744xx to TPS74401 throughout document	1
• Deleted fixed output Features bullet.....	1
• Changed V_{BIAS} minimum value in <i>Recommended Operating Conditions</i> table.....	6
• Changed footnote 1 for <i>Recommended Operating Conditions</i> table.....	6
• Added second row to V_{OUT} accuracy parameter	7
• Added last four rows to V_{DO} , V_{BIAS} dropout voltage parameter	7
• Added <i>Timing Requirements</i> table	8
• Added <i>Device Functional Modes</i> section	15
• Changed third paragraph of <i>Dropout Voltage</i>	19
• Changed first sentence of <i>Without an Auxiliary Bias</i> section	24
• Changed <i>Power Dissipation</i> section location; moved to after <i>Layout Example</i> section.....	25
• Added <i>Development Support</i> section	29
• Added information about reference design TIDU421 and user guide SLVU143 to <i>Related Documentation</i> section	29

Changes from Revision O (March 2013) to Revision P
Page

• Deleted Active High Enable bullet from <i>Features</i> list	1
• Added <i>ESD Ratings</i> table, <i>Feature Description</i> section, <i>Device Functional Modes</i> , <i>Application and Implementation</i> section, <i>Power Supply Recommendations</i> section, <i>Layout</i> section, <i>Device and Documentation Support</i> section, and <i>Mechanical, Packaging, and Orderable Information</i> section	6
• Changed footnote 3c for <i>Thermal Information</i> table	7
• Changed y-axis in Figure 1 , Figure 2 , Figure 4 , and Figure 7 from abbreviation (I_{OUT}) to text (Output Current)	9
• Added "V" to $V_{IN} = 1.8$ V condition in Figure 9 , Figure 10 , and Figure 11	9
• y-axis and graph title in Figure 15 from abbreviation (I_{OUT}) to text (Output Current)	10
• Changed Figure 25 ; made V_{OUT} trace red to show data trend separation	12
• Changed <i>Overview</i> section text.....	14
• Changed second paragraph of <i>Dropout Voltage</i>	19
• Changed Figure 27 ; updated equation in figure	20

Changes from Revision N (December 2012) to Revision O
Page

• Changed RGW and KTW values in Thermal Information table.....	7
--	---

Changes from Revision M (November 2010) to Revision N
Page

• Changed T_j max value from 125 to 150 in Absolute Maximum Ratings table.....	6
--	---

Changes from Revision L (August, 2010) to Revision M **Page**

- Corrected equation for [Table 2](#) 17
-

Changes from Revision K (December, 2009) to Revision L **Page**

- Replaced the *Dissipation Ratings* table with the *Thermal Information* table 7
 - Revised *Layout Recommendations and Power Dissipation* section 25
 - Revised *Thermal Considerations* section 26
-

5 Pin Configuration and Functions

RGW, RGR Package
5-mm × 5-mm and 3.5-mm × 3.5-mm, 20-Pin VQFN
Top View

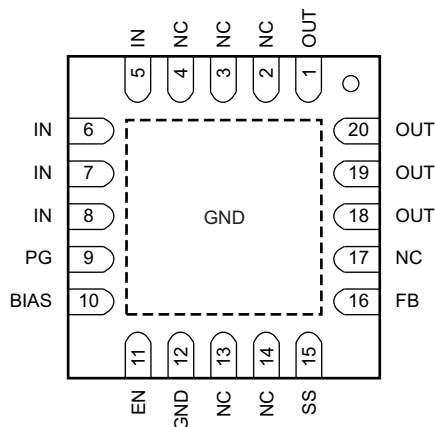

KTW Package
7-Pin DDPACK
Top View

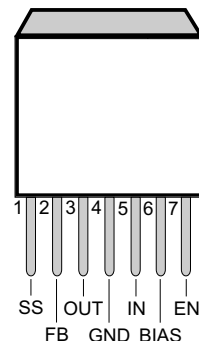

Pin Functions

NAME	PIN		I/O	DESCRIPTION
	KTW	RGW, RGR		
BIAS	6	10	I	Bias input voltage for error amplifier, reference, and internal control circuits. A 1- μ F or larger bias capacitor is recommended for optimal performance. If IN is connected to BIAS, use a 4.7 μ F or larger capacitor.
EN	7	11	I	Enable pin. Driving this pin high enables the regulator. Driving this pin low puts the regulator into shutdown mode. This pin must not be left floating.
FB	2	16	I	This pin is the feedback connection to the center tap of an external resistor divider network that sets the output voltage. This pin must not be left floating.
GND	4	12	—	Ground
IN	5	5–8	I	Unregulated input to the device. An input capacitor of 1 μ F or greater is recommended for optimal performance.
NC	N/A	2–4, 13, 14, 17	—	No connection. This pin can be left floating or connected to GND to allow better thermal contact to the top-side plane.
OUT	3	1, 18–20	O	Regulated output voltage. No capacitor is required on this pin for stability, but is recommended for optimal performance.
PAD/TAB	—	—	—	Must be soldered to the ground plane for increased thermal performance. Internally connected to ground.
PG	N/A	9	O	Power-good (PG) is an open-drain, active-high output that indicates the status of V_{OUT} . When V_{OUT} exceeds the PG trip threshold, the PG pin goes into a high-impedance state. When V_{OUT} is below this threshold, the pin is driven to a low-impedance state. Connect a pullup resistor from 10 k Ω to 1 M Ω from this pin to a supply up to 5.5 V. The supply can be higher than the input voltage. Alternatively, the PG pin can be left floating if output monitoring is not necessary.
SS	1	15	—	Soft-start pin. A capacitor connected on this pin to ground sets the start-up time. If this pin is left floating, the regulator output soft-start ramp time is typically 100 μ s.

6 Specifications

6.1 Absolute Maximum Ratings

over operating free-air temperature range (unless otherwise noted)⁽¹⁾

		MIN	MAX	UNIT
V_{IN}, V_{BIAS}	Input voltage	-0.3	6	V
V_{EN}	Enable voltage	-0.3	6	V
V_{PG}	Power-good voltage	-0.3	6	V
I_{PG}	PG sink current	0	1.5	mA
V_{SS}	SS pin voltage	-0.3	6	V
V_{FB}	Feedback pin voltage	-0.3	6	V
V_{OUT}	Output voltage	-0.3	$V_{IN} + 0.3$	V
I_{OUT}	Maximum output current	Internally limited		
	Output short-circuit duration	Indefinite		
P_{DISS}	Continuous total power dissipation	See Thermal Information		
T_J	Operating junction temperature	-40	150	°C
T_{stg}	Storage temperature	-55	150	°C

(1) Stresses beyond those listed under *Absolute Maximum Ratings* may cause permanent damage to the device. These are stress ratings only, which do not imply functional operation of the device at these or any other conditions beyond those indicated under *Recommended Operating Conditions*. Exposure to absolute-maximum-rated conditions for extended periods may affect device reliability.

6.2 ESD Ratings

		VALUE	UNIT
$V_{(ESD)}$	Electrostatic discharge	Human body model (HBM), per ANSI/ESDA/JEDEC JS-001 ⁽¹⁾	±2000
		Charged device model (CDM), per JEDEC specification JESD22-C101 ⁽²⁾	±500

(1) JEDEC document JEP155 states that 500-V HBM allows safe manufacturing with a standard ESD control process.

(2) JEDEC document JEP157 states that 250-V CDM allows safe manufacturing with a standard ESD control process.

6.3 Recommended Operating Conditions

over operating free-air temperature range (unless otherwise noted)

		MIN	NOM	MAX	UNIT
V_{IN}	Input supply voltage range	1.1		5.5	V
V_{EN}	Enable supply voltage range	0		5.5	V
$V_{BIAS}^{(1)}$	BIAS supply voltage range	$V_{OUT} + V_{DO} (V_{BIAS})$		5.5	V
I_{OUT}	Output current	0		3	A
C_{OUT}	Output capacitor	0			µF
$C_{IN}^{(2)}$	Input capacitor	1			µF
C_{BIAS}	Bias capacitor	1			µF
T_J	Operating junction temperature	-40		125	°C

(1) BIAS supply is required when V_{IN} is below $V_{OUT} + V_{DO} (V_{BIAS})$.

(2) If V_{IN} and V_{BIAS} are connected to the same supply, the recommended minimum capacitor for the supply is 4.7 µF.

6.4 Thermal Information

THERMAL METRIC ⁽¹⁾⁽²⁾		TPS74401 ⁽³⁾			UNIT
		RGW (VQFN)	RGR (VQFN)	KTW (DDPAK)	
		20 PINS	20 PINS	7 PINS	
R _{θJA}	Junction-to-ambient thermal resistance	35.4	39.1	26.6	°C/W
R _{θJC(top)}	Junction-to-case (top) thermal resistance	32.4	29.3	41.7	°C/W
R _{θJB}	Junction-to-board thermal resistance	14.7	10.2	12.5	°C/W
ψ _{JT}	Junction-to-top characterization parameter	0.4	0.4	4.0	°C/W
ψ _{JB}	Junction-to-board characterization parameter	14.8	10.1	7.3	°C/W
R _{θJC(bot)}	Junction-to-case (bottom) thermal resistance	3.9	2.0	0.3	°C/W

- (1) For more information about traditional and new thermal metrics, see the [Semiconductor and IC Package Thermal Metrics](#) application report.
- (2) For thermal estimates of this device based on PCB copper area, see the [TI PCB Thermal Calculator](#).
- (3) Thermal data for the RGW, RGR, and KTW packages are derived by thermal simulations based on JEDEC-standard methodology as specified in the JESD51 series. The following assumptions are used in the simulations:
 - (a) i. RGW and RGR: The exposed pad is connected to the PCB ground layer through a 4x4 thermal via array.
 - ii. KTW: The exposed pad is connected to the PCB ground layer through a 6x6 thermal via array.
 - (b) Each of top and bottom copper layers has a dedicated pattern for 20% copper coverage.
 - (c) These data were generated with only a single device at the center of a JEDEC high-K (2s2p) board with 3in x 3in copper area. To understand the effects of the copper area on thermal performance, refer to the [Thermal Considerations](#) section.

6.5 Electrical Characteristics

At $V_{EN} = 1.1\text{ V}$, $V_{IN} = V_{OUT} + 0.3\text{ V}$, $C_{IN} = C_{BIAS} = 0.1\text{ }\mu\text{F}$, $C_{OUT} = 10\text{ }\mu\text{F}$, $I_{OUT} = 50\text{ mA}$, $V_{BIAS} = 5.0\text{ V}$, and $T_J = -40^\circ\text{C}$ to 125°C , unless otherwise noted. Typical values are at $T_J = 25^\circ\text{C}$.

PARAMETER		TEST CONDITIONS	MIN	TYP	MAX	UNIT
V _{IN}	Input voltage range		V _{OUT} + V _{DO}		5.5	V
V _{BIAS}	Bias pin voltage range		2.375		5.25	V
V _{REF}	Internal reference	T _J = 25°C	0.796	0.8	0.804	V
V _{OUT}	Output voltage range	V _{IN} = 5 V, I _{OUT} = 1.5 A, V _{BIAS} = 5 V	V _{REF}		3.6	V
	Accuracy	2.97 V ≤ V _{BIAS} ≤ 5.25 V, V _{OUT} + 1.62 V ≤ V _{BIAS} , 50 mA ≤ I _{OUT} ≤ 3.0 A ⁽¹⁾	-1%	±0.2%	1%	
		V _{OUT} + V _{DO} BIAS ≤ V _{BIAS} ≤ 5.25 V, 100 mA ≤ I _{OUT} ≤ I _{VDO BIAS} , VQFN ⁽²⁾	-1%	±0.2%	1%	
ΔV _{OUT(ΔVIN)}	Line regulation	V _{OUT(nom)} + 0.3 ≤ V _{IN} ≤ 5.5 V, VQFN		0.0005	0.05	%V
		V _{OUT(nom)} + 0.3 ≤ V _{IN} ≤ 5.5 V, DDPAK		0.0005	0.06	
ΔV _{OUT(ΔIOUT)}	Load regulation	0 mA ≤ I _{OUT} ≤ 50 mA		0.013		%mA
		50 mA ≤ I _{OUT} ≤ 3.0 A		0.03		%A
V _{DO}	V _{IN} dropout voltage ⁽³⁾	I _{OUT} = 3.0 A, V _{BIAS} - V _{OUT(nom)} ≥ 1.62 V, VQFN		115	195	mV
		I _{OUT} = 3.0 A, V _{BIAS} - V _{OUT(nom)} ≥ 1.62 V, DDPAK		120	240	
	V _{BIAS} dropout voltage ⁽³⁾	I _{OUT} = 3.0 A, V _{IN} = V _{BIAS}			1.62	V
		I _{OUT} = 3.0 A			1.62	
		I _{OUT} = 1.0 A			1.35	
		I _{OUT} = 500 mA			1.27	
	I _{OUT} = 100 mA			1.16		
I _{CL}	Current limit	V _{OUT} = 80% × V _{OUT(nom)} , VQFN	3.8		6.0	A
		V _{OUT} = 80% × V _{OUT(nom)} , DDPAK	3.5		6.0	
I _{BIAS}	Bias pin current	I _{OUT} = 0 mA to 3.0 A		2	4	mA
I _{SHDN}	Shutdown supply current (V _{IN})	V _{EN} ≤ 0.4 V		1	100	μA
I _{FB}	Feedback pin current ⁽⁴⁾	I _{OUT} = 50 mA to 3.0 A	-250	95	250	nA

- (1) Devices tested at 0.8 V; external resistor tolerance is not taken into account.
- (2) V_{OUT} is set to 1.5 V to avoid minimum V_{BIAS} restrictions.
- (3) Dropout is defined as the voltage from the input to V_{OUT} when V_{OUT} is 2% below nominal.
- (4) I_{FB} current flow is out of the device.

Electrical Characteristics (continued)

At $V_{EN} = 1.1\text{ V}$, $V_{IN} = V_{OUT} + 0.3\text{ V}$, $C_{IN} = C_{BIAS} = 0.1\text{ }\mu\text{F}$, $C_{OUT} = 10\text{ }\mu\text{F}$, $I_{OUT} = 50\text{ mA}$, $V_{BIAS} = 5.0\text{ V}$, and $T_J = -40^\circ\text{C}$ to 125°C , unless otherwise noted. Typical values are at $T_J = 25^\circ\text{C}$.

PARAMETER		TEST CONDITIONS	MIN	TYP	MAX	UNIT
PSRR ⁽⁵⁾	Power-supply rejection (V_{IN} to V_{OUT})	1 kHz, $I_{OUT} = 1.5\text{ A}$, $V_{IN} = 1.8\text{ V}$, $V_{OUT} = 1.5\text{ V}$		73		dB
		800 kHz, $I_{OUT} = 1.5\text{ A}$, $V_{IN} = 1.8\text{ V}$, $V_{OUT} = 1.5\text{ V}$		42		
	Power-supply rejection (V_{BIAS} to V_{OUT})	1 kHz, $I_{OUT} = 1.5\text{ A}$, $V_{IN} = 1.8\text{ V}$, $V_{OUT} = 1.5\text{ V}$		62		dB
		800 kHz, $I_{OUT} = 1.5\text{ A}$, $V_{IN} = 1.8\text{ V}$, $V_{OUT} = 1.5\text{ V}$		50		
V_n	Output noise voltage	100 Hz to 100 kHz, $I_{OUT} = 1.5\text{ A}$, $C_{SS} = 0.001\text{ }\mu\text{F}$		$16 \times V_{OUT}$		μV_{RMS}
V_{TRAN}	% V_{OUT} droop during load transient	$I_{OUT} = 100\text{ mA}$ to 3.0 A at $1\text{ A}/\mu\text{s}$, $C_{OUT} = 0\text{ }\mu\text{F}$		4		% V_{OUT}
I_{SS}	Soft-start charging current	$V_{SS} = 0.4\text{ V}$	0.5	0.73	1	μA
$V_{EN(high)}$	Enable input high level		1.1		5.5	V
$V_{EN(low)}$	Enable input low level		0		0.4	V
$V_{EN(hys)}$	Enable pin hysteresis			50		mV
I_{EN}	Enable pin current	$V_{EN} = 5\text{ V}$		0.1	1	μA
V_{IT}	PG trip threshold	V_{OUT} decreasing	86.5	90	93.5	% V_{OUT}
V_{HYS}	PG trip hysteresis			3		% V_{OUT}
$V_{PG(low)}$	PG output low voltage	$I_{PG} = 1\text{ mA}$ (sinking), $V_{OUT} < V_{IT}$			0.3	V
$I_{PG(ikg)}$	PG leakage current	$V_{PG} = 5.25\text{ V}$, $V_{OUT} > V_{IT}$		0.03	1	μA
T_J	Operating junction temperature		-40		125	$^\circ\text{C}$
T_{SD}	Thermal shutdown temperature	Shutdown, temperature increasing		155		$^\circ\text{C}$
		Reset, temperature decreasing		140		

(5) See [Figure 8](#) to [Figure 11](#) for PSRR at different conditions.

6.6 Timing Requirements

At $V_{EN} = 1.1\text{ V}$, $V_{IN} = V_{OUT} + 0.3\text{ V}$, $C_{IN} = C_{BIAS} = 0.1\text{ }\mu\text{F}$, $C_{OUT} = 10\text{ }\mu\text{F}$, $I_{OUT} = 50\text{ mA}$, $V_{BIAS} = 5.0\text{ V}$, and $T_J = -40^\circ\text{C}$ to 125°C , unless otherwise noted. Typical values are at $T_J = 25^\circ\text{C}$.

		MIN	NOM	MAX	UNIT
t_{STR}	Minimum startup time ($I_{OUT} = 1.5\text{ A}$, $C_{SS} = \text{open}$)		100		μs
$V_{EN(dg)}$	Enable pin de-glitch time		20		μs

6.7 Typical Characteristics

At $T_J = 25^\circ\text{C}$, $V_{OUT} = 1.5\text{ V}$, $V_{IN} = V_{OUT(nom)} + 0.3\text{ V}$, $V_{BIAS} = 3.3\text{ V}$, $I_{OUT} = 50\text{ mA}$, $C_{IN} = 1\ \mu\text{F}$, $C_{BIAS} = 1\ \mu\text{F}$, $C_{SS} = 0.01\ \mu\text{F}$, and $C_{OUT} = 10\ \mu\text{F}$, unless otherwise noted.

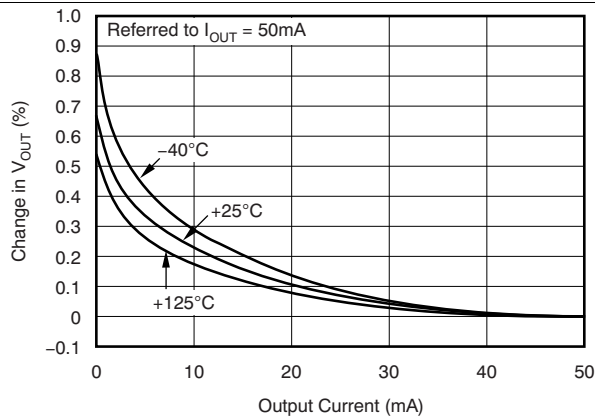

Figure 1. Load Regulation

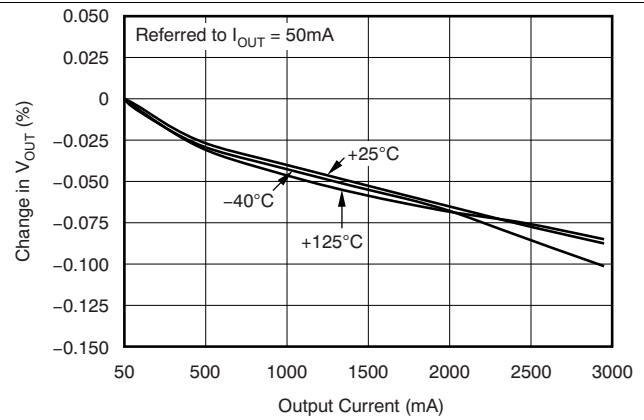

Figure 2. Load Regulation

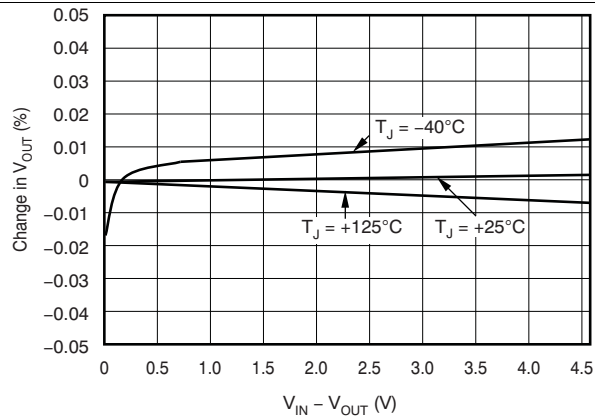

Figure 3. Line Regulation

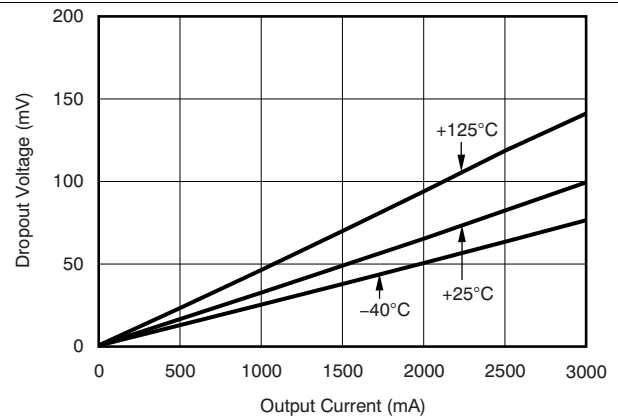

Figure 4. V_{IN} Dropout Voltage vs I_{OUT} and Temperature (T_J)

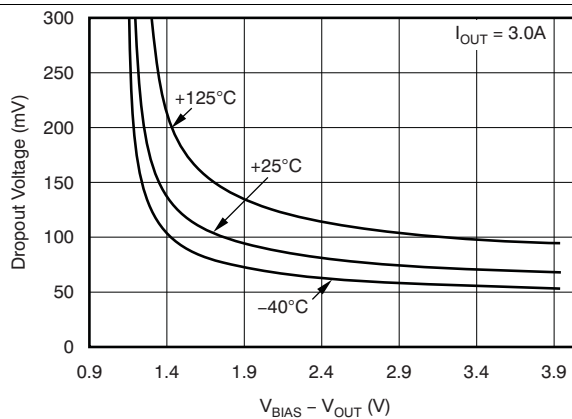

Figure 5. V_{IN} Dropout Voltage vs $V_{BIAS} - V_{OUT}$ and Temperature (T_J)

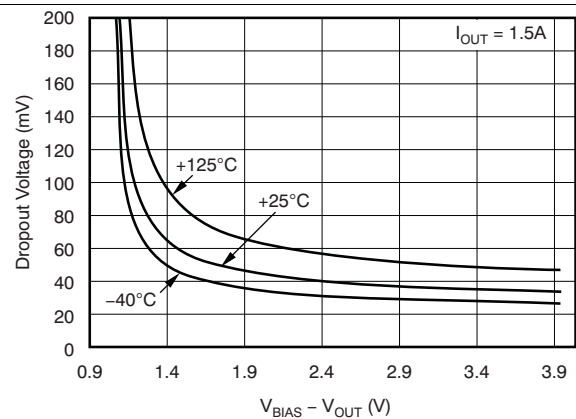

Figure 6. V_{IN} Dropout Voltage vs $V_{BIAS} - V_{OUT}$ and Temperature (T_J)

Typical Characteristics (continued)

At $T_J = 25^\circ\text{C}$, $V_{OUT} = 1.5\text{ V}$, $V_{IN} = V_{OUT(nom)} + 0.3\text{ V}$, $V_{BIAS} = 3.3\text{ V}$, $I_{OUT} = 50\text{ mA}$, $C_{IN} = 1\ \mu\text{F}$, $C_{BIAS} = 1\ \mu\text{F}$, $C_{SS} = 0.01\ \mu\text{F}$, and $C_{OUT} = 10\ \mu\text{F}$, unless otherwise noted.

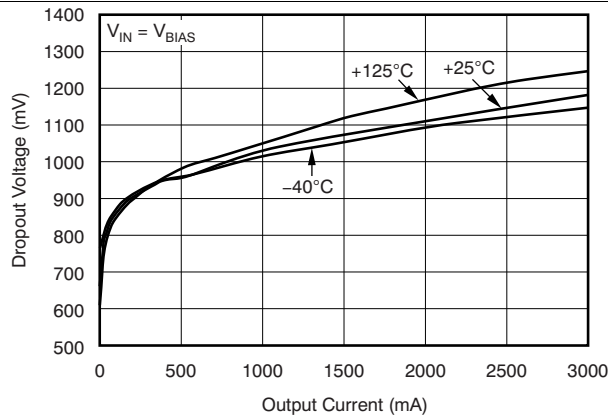

Figure 7. V_{BIAS} Dropout Voltage vs I_{OUT} and Temperature (T_J)

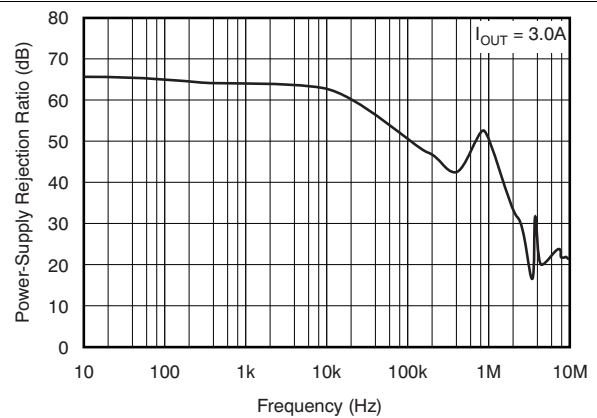

Figure 8. V_{BIAS} PSRR vs Frequency

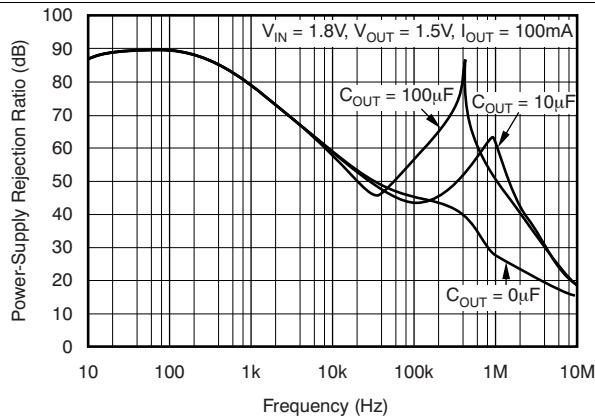

Figure 9. V_{IN} PSRR vs Frequency

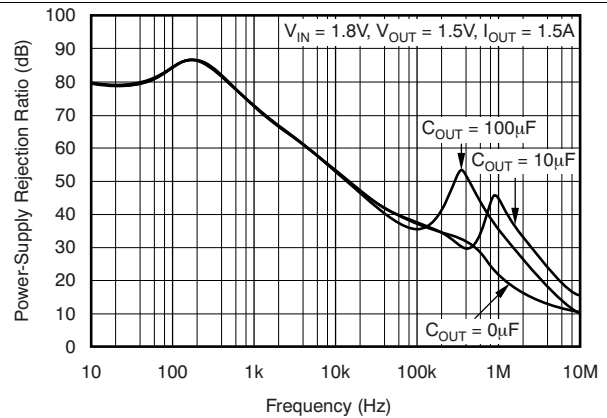

Figure 10. V_{IN} PSRR vs Frequency

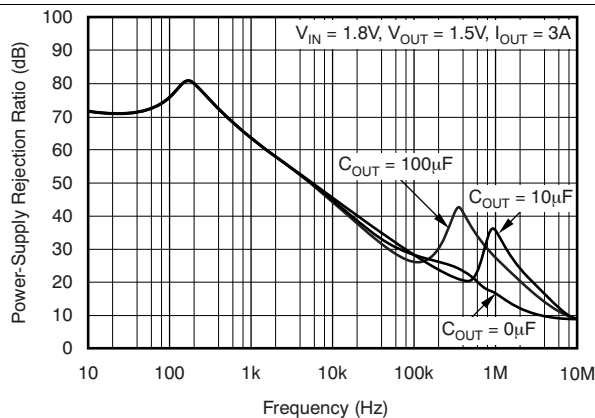

Figure 11. V_{IN} PSRR vs Frequency

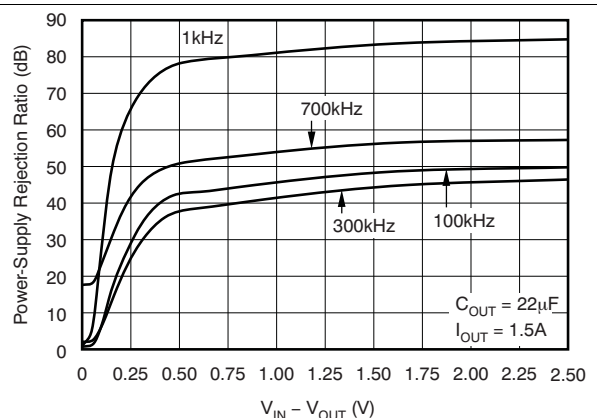

Figure 12. V_{IN} PSRR vs $V_{IN} - V_{OUT}$

Typical Characteristics (continued)

At $T_J = 25^\circ\text{C}$, $V_{OUT} = 1.5\text{ V}$, $V_{IN} = V_{OUT(nom)} + 0.3\text{ V}$, $V_{BIAS} = 3.3\text{ V}$, $I_{OUT} = 50\text{ mA}$, $C_{IN} = 1\ \mu\text{F}$, $C_{BIAS} = 1\ \mu\text{F}$, $C_{SS} = 0.01\ \mu\text{F}$, and $C_{OUT} = 10\ \mu\text{F}$, unless otherwise noted.

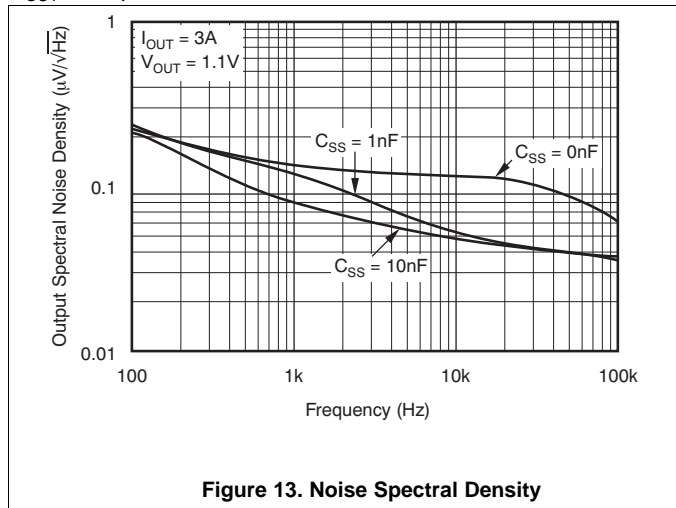

Figure 13. Noise Spectral Density

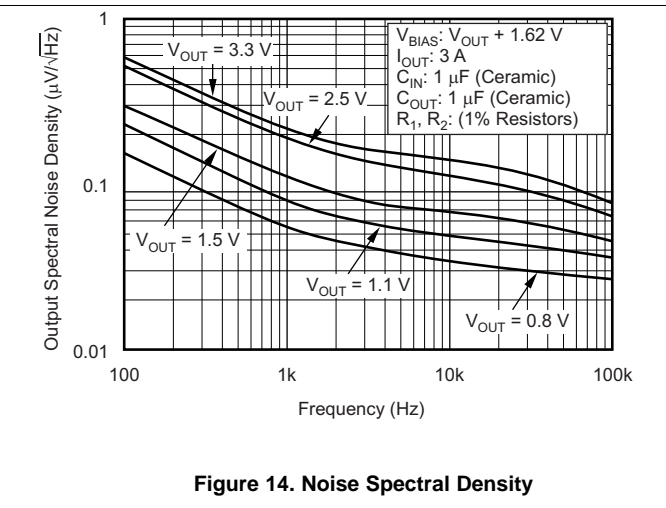

Figure 14. Noise Spectral Density

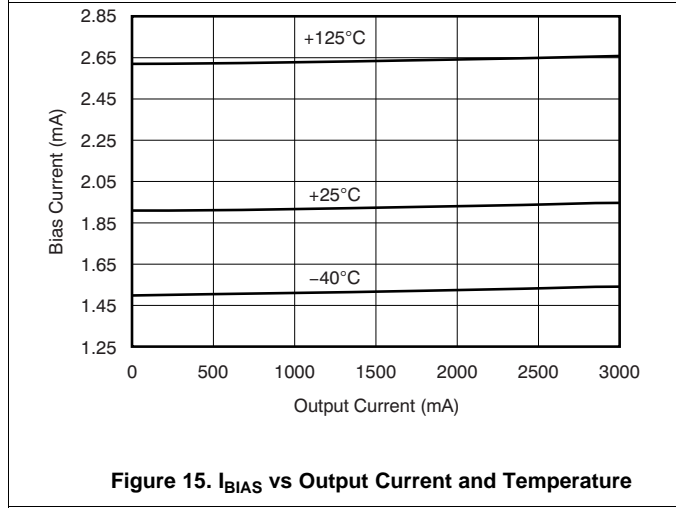

Figure 15. I_{BIAS} vs Output Current and Temperature

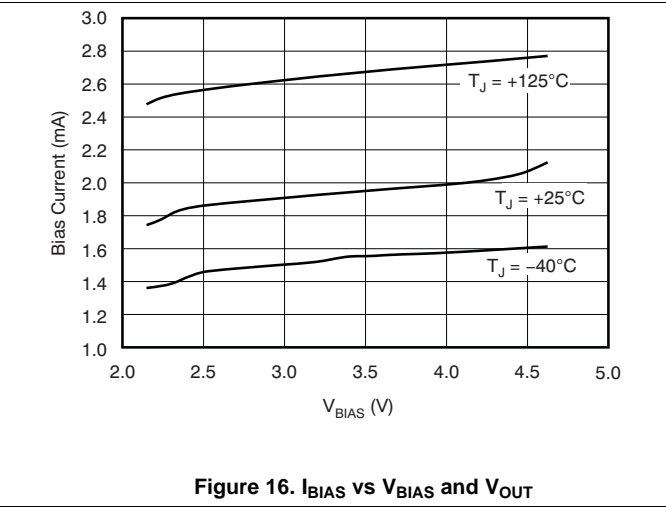

Figure 16. I_{BIAS} vs V_{BIAS} and V_{OUT}

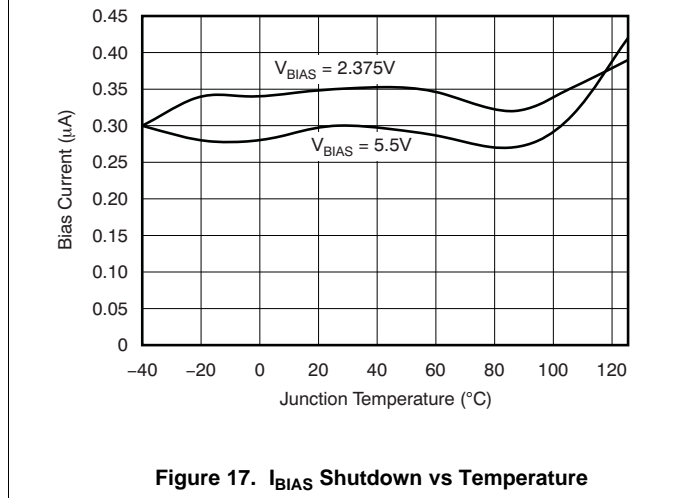

Figure 17. I_{BIAS} Shutdown vs Temperature

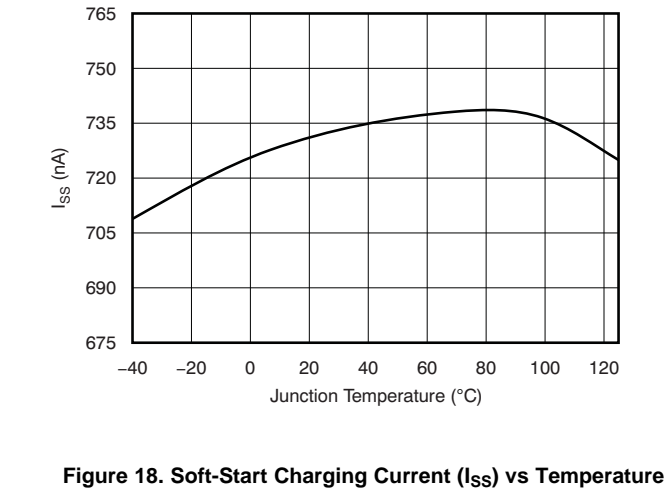

Figure 18. Soft-Start Charging Current (I_{SS}) vs Temperature

Typical Characteristics (continued)

At $T_J = 25^\circ\text{C}$, $V_{OUT} = 1.5\text{ V}$, $V_{IN} = V_{OUT(\text{nom})} + 0.3\text{ V}$, $V_{BIAS} = 3.3\text{ V}$, $I_{OUT} = 50\text{ mA}$, $C_{IN} = 1\ \mu\text{F}$, $C_{BIAS} = 1\ \mu\text{F}$, $C_{SS} = 0.01\ \mu\text{F}$, and $C_{OUT} = 10\ \mu\text{F}$, unless otherwise noted.

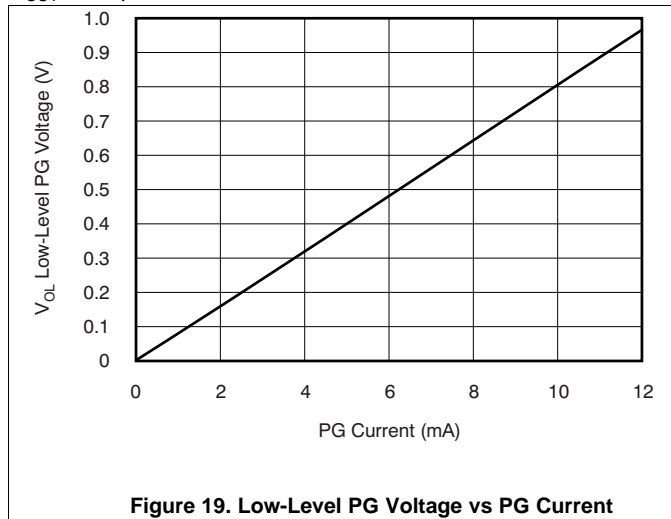

Figure 19. Low-Level PG Voltage vs PG Current

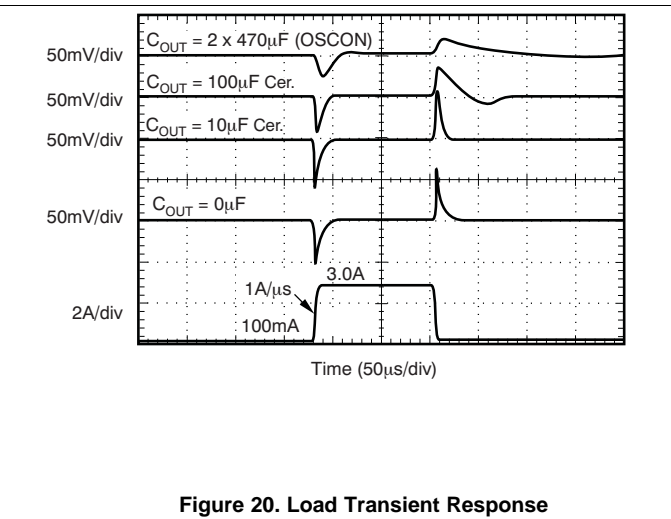

Figure 20. Load Transient Response

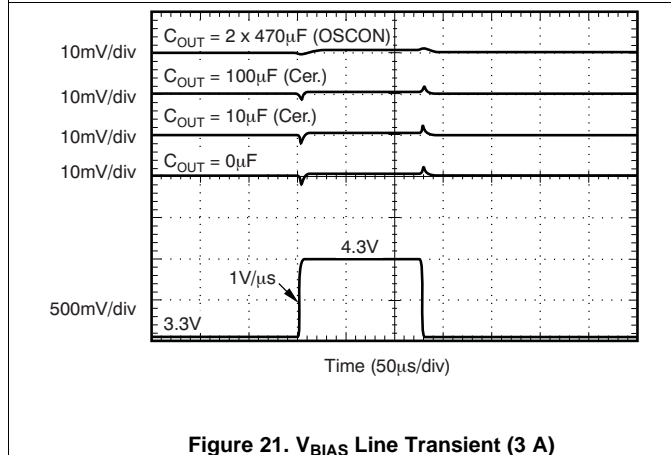

Figure 21. V_{BIAS} Line Transient (3 A)

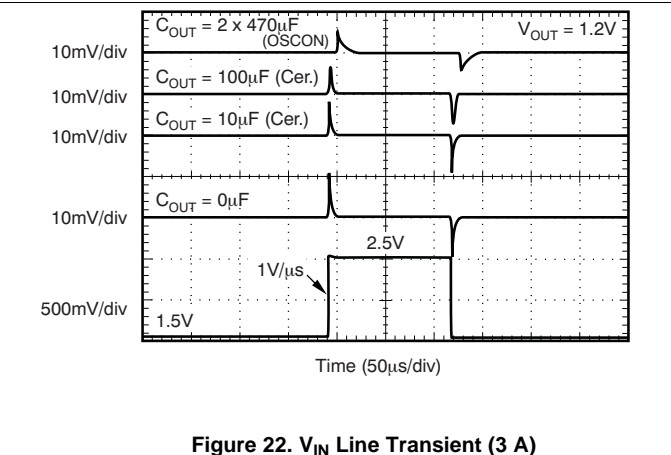

Figure 22. V_{IN} Line Transient (3 A)

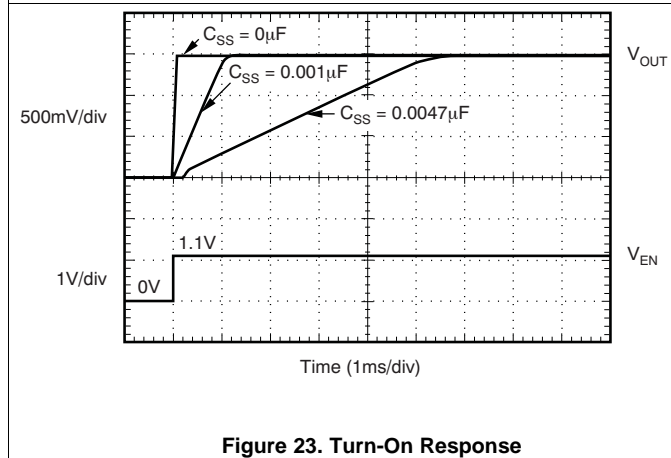

Figure 23. Turn-On Response

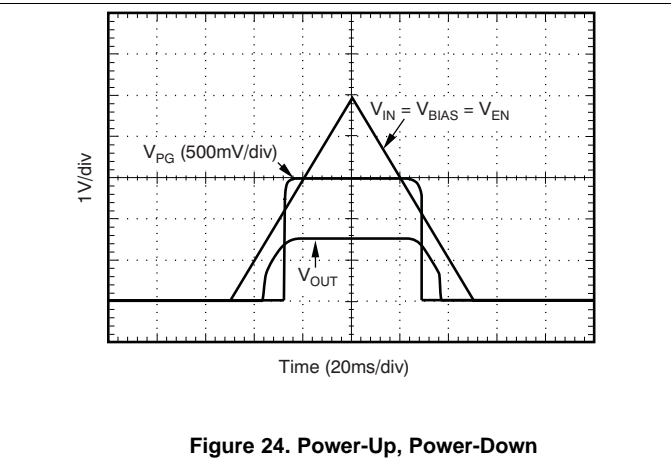

Figure 24. Power-Up, Power-Down

Typical Characteristics (continued)

At $T_J = 25^\circ\text{C}$, $V_{OUT} = 1.5\text{ V}$, $V_{IN} = V_{OUT(nom)} + 0.3\text{ V}$, $V_{BIAS} = 3.3\text{ V}$, $I_{OUT} = 50\text{ mA}$, $C_{IN} = 1\ \mu\text{F}$, $C_{BIAS} = 1\ \mu\text{F}$, $C_{SS} = 0.01\ \mu\text{F}$, and $C_{OUT} = 10\ \mu\text{F}$, unless otherwise noted.

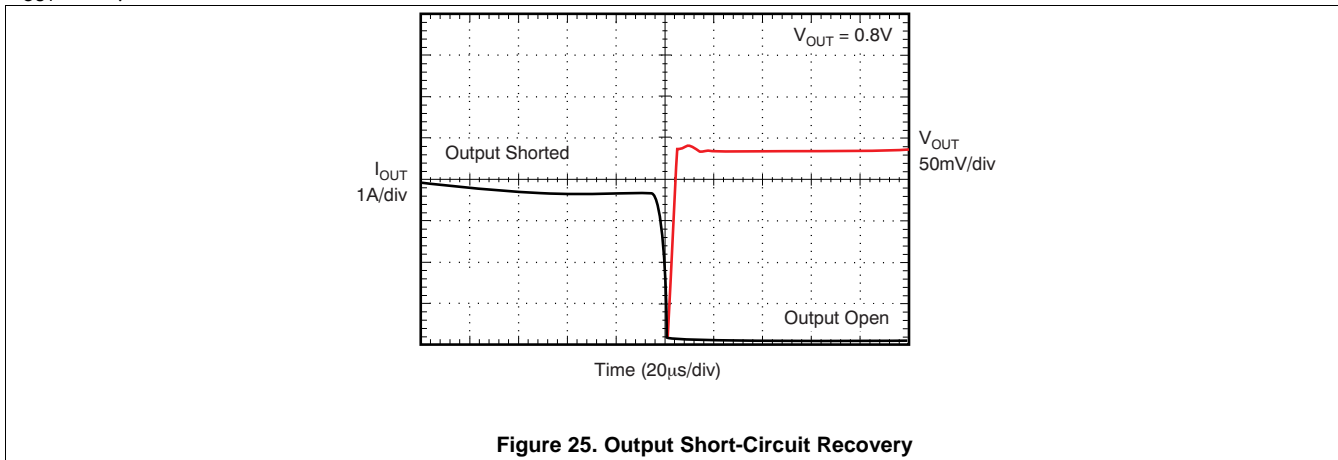

Figure 25. Output Short-Circuit Recovery

7 Detailed Description

7.1 Overview

The TPS74401 family of low-dropout regulators (LDOs) incorporates many features to ensure a wide range of uses. Hysteresis and de-glitch on the EN input improve the ability to sequence multiple devices without worrying about false start-up. The soft-start is fully programmable and allows the user to control the startup time of the LDO output. Hysteresis is also available on the PG comparator to ensure no false PG signals. The TPS74401 family of LDOs is ideal for FPGAs, DSPs, and any other device that requires linear supply and sequencing.

7.2 Functional Block Diagram

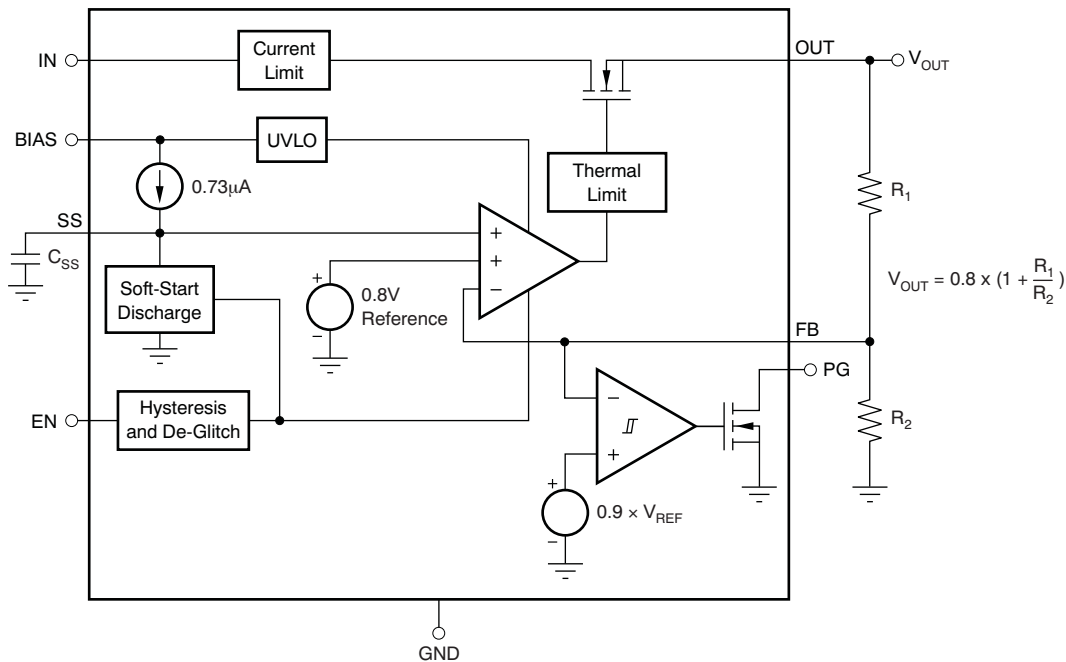

7.3 Feature Description

7.3.1 Enable, Shutdown

The enable (EN) pin is active high and compatible with standard digital signaling levels. V_{EN} lower than 0.4V turns the regulator off, whereas V_{EN} above 1.1V turns the regulator on. Unlike many regulators, the enable circuitry has hysteresis and de-glitching for use with relatively slow-ramping analog signals. This configuration allows the TPS74401 to be enabled by connecting the output of another supply to the EN pin. The enable circuitry typically has 50mV of hysteresis and a de-glitch circuit to help avoid on-off cycling resulting from small glitches in the V_{EN} signal.

The enable threshold is typically 0.8V and varies with temperature and process variations. Temperature variation is approximately $-1\text{mV}/^\circ\text{C}$; therefore, process variation accounts for most of the variation in the enable threshold. If precise turn-on timing is required, use a fast rise-time signal to enable the TPS74401.

If not used, EN can be connected to either IN or BIAS. If EN is connected to IN, connect EN as close as possible to the largest capacitance on the input to prevent voltage droops on that line from triggering the enable circuit.

Feature Description (continued)

7.3.2 Power-Good (VQFN Package Only)

The power-good (PG) pin is an open-drain output and can be connected to any 5.5 V or lower rail through an external pullup resistor. This pin requires at least 1.1 V on V_{BIAS} in order to have a valid output. The PG output is high-impedance when V_{OUT} is greater than $(V_{IT} + V_{HYS})$. If V_{OUT} drops below V_{IT} or if V_{BIAS} drops below 1.9 V, the open-drain output turns on and pulls the PG output low. The PG pin also asserts when the device is disabled. The recommended operating condition of the PG pin sink current is up to 1 mA, thus the pullup resistor for PG must be in the range of 10 k Ω to 1 M Ω . PG is only provided on the VQFN package. If output voltage monitoring is not needed, the PG pin can be left floating.

7.3.3 Internal Current Limit

The TPS74401 features a factory-trimmed, accurate current limit that is flat over temperature and supply voltage. The current limit allows the device to supply surges of up to 3.5 A and maintain regulation. The current limit responds in approximately 10 μ s to reduce the current during a short-circuit fault. Recovery from a short-circuit condition is well-controlled and results in very little output overshoot when the load is removed. See [Figure 25](#) in the [Typical Characteristics](#) section for short-circuit recovery performance.

The internal current limit protection circuitry of the TPS74401 is designed to protect against overload conditions. This circuitry is not intended to allow operation above the rated current of the device. Continuously running the TPS74401 above the rated current degrades device reliability.

7.3.4 Thermal Protection

Thermal protection disables the output when the junction temperature rises to approximately 155°C, allowing the device to cool. When the junction temperature cools to approximately 140°C, the output circuitry is enabled. Depending on power dissipation, thermal resistance, and ambient temperature the thermal protection circuit can cycle on and off. This cycling limits the dissipation of the regulator, protecting it from damage as a result of overheating.

Activation of the thermal protection circuit indicates excessive power dissipation or inadequate heatsinking. For reliable operation, limit junction temperature to 125°C maximum. To estimate the margin of safety in a complete design (including heatsink), increase the ambient temperature until thermal protection is triggered; use worst-case loads and signal conditions. For good reliability, trigger thermal protection at least 30°C above the maximum expected ambient condition of the application. This condition produces a worst-case junction temperature of 125°C at the highest expected ambient temperature and worst-case load.

The internal protection circuitry of the TPS74401 is designed to protect against overload conditions. This circuitry is not intended to replace proper heatsinking. Continuously running the TPS74401 into thermal shutdown degrades device reliability.

7.4 Device Functional Modes

7.4.1 Normal Operation

The device regulates to the nominal output voltage under the following conditions:

- The input voltage and bias voltage are both at least at the respective minimum specifications.
- The enable voltage has previously exceeded the enable rising threshold voltage and has not decreased below the enable falling threshold.
- The output current is less than the current limit.
- The device junction temperature is less than the maximum specified junction temperature.
- The device is not operating in dropout.

7.4.2 Dropout Operation

If the input voltage is lower than the nominal output voltage plus the specified dropout voltage, but all other conditions are met for normal operation, the device operates in dropout mode. In this condition, the output voltage is the same as the input voltage minus the dropout voltage. The transient performance of the device is significantly degraded because the pass device is in a triode state and no longer controls the current through the LDO. Line or load transients in dropout can result in large output voltage deviations.

Device Functional Modes (continued)

7.4.3 Disabled

The device is disabled under the following conditions:

- The input or bias voltages are below the respective minimum specifications.
- The enable voltage is less than the enable falling threshold voltage or has not yet exceeded the enable rising threshold.
- The device junction temperature is greater than the thermal shutdown temperature.

Table 1 shows the conditions that lead to the different modes of operation.

Table 1. Device Functional Mode Comparison

OPERATING MODE	PARAMETER				
	V _{IN}	V _{EN}	V _{BIAS}	I _{OUT}	T _J
Normal mode	V _{IN} > V _{OUT(nom)} + V _{DO} (V _{IN})	V _{EN} > V _{EN(high)}	V _{BIAS} ≥ V _{OUT} + 1.62 V	I _{OUT} < I _{CL}	T _J < 125°C
Dropout mode	V _{IN} < V _{OUT(nom)} + V _{DO} (V _{IN})	V _{EN} > V _{EN(high)}	V _{BIAS} < V _{OUT} + 1.62 V	—	T _J < 125°C
Disabled mode (any true condition disables the device)	V _{IN} < V _{IN(min)}	V _{EN} < V _{EN(low)}	V _{BIAS} < V _{BIAS(min)}	—	T _J > 155°C

7.5 Programming

7.5.1 Programmable Soft-Start

The TPS74401 features a programmable, monotonic, voltage-controlled soft-start that is set with an external capacitor (C_{SS}). This feature is important for many applications to eliminate power-up initialization problems when powering FPGAs, DSPs, or other processors. The controlled voltage ramp of the output also reduces peak inrush current during start-up, minimizing start-up transients to the input power bus.

To achieve a linear and monotonic soft-start, the TPS74401 error amplifier tracks the voltage ramp of the external soft-start capacitor until the voltage exceeds the internal reference. The soft-start ramp time depends on the soft-start charging current (I_{SS}), the soft-start capacitance (C_{SS}), and the internal reference voltage (V_{REF}), and can be calculated using Equation 1:

$$t_{SS} = \frac{(V_{REF} \times C_{SS})}{I_{SS}} \quad (1)$$

If large output capacitors are used, the device current limit (I_{CL}) and the output capacitor can set the start-up time. In this case, the start-up time is given by Equation 2:

$$t_{SSCL} = \frac{(V_{OUT(nom)} \times C_{OUT})}{I_{CL(min)}} \quad (2)$$

where

- V_{OUT(nom)} is the nominal set output voltage as set by the user,
- C_{OUT} is the output capacitance,
- and I_{CL(min)} is the minimum current limit for the device.

In applications where monotonic startup is required, the soft-start time given by Equation 1 must be set to be greater than Equation 2.

Programming (continued)

The maximum recommended soft-start capacitor is 0.015 μF . Larger soft-start capacitors can be used and do not damage the device; however, the soft-start capacitor discharge circuit may not be able to fully discharge the soft-start capacitor when re-enabled. Soft-start capacitors larger than 0.015 μF can be a problem in applications where the user must rapidly pulse the enable pin and also require the device to soft-start from ground. C_{SS} must be low-leakage; X7R, X5R, or C0G dielectric materials are preferred. Table 2 lists suggested soft-start capacitor values.

Table 2. Standard Capacitor Values for Programming the Soft-Start Time⁽¹⁾

C_{SS}	SOFT-START TIME
Open	0.1 ms
470 pF	0.5 ms
1000 pF	1 ms
4700 pF	5 ms
0.01 μF	10 ms
0.015 μF	16 ms

$$(1) \quad t_{\text{SS}}(\text{s}) = \frac{V_{\text{REF}} \times C_{\text{SS}}}{I_{\text{SS}}} = \frac{0.8\text{V} \times C_{\text{SS}}(\text{F})}{0.73\mu\text{A}} \quad \text{where } t_{\text{SS}}(\text{s}) = \text{soft-start time in seconds.}$$

7.5.2 Sequencing Requirements

The device can have V_{IN} , V_{BIAS} , and V_{EN} sequenced in any order without causing damage to the device. However, for the soft-start function to work as intended, certain sequencing rules must be applied. Enabling the device after V_{IN} and V_{BIAS} are present is preferred, and can be accomplished using a digital output from a processor or supply supervisor. An analog signal from an external RC circuit, as shown in Figure 26, can also be used as long as the delay time is long enough for V_{IN} and V_{BIAS} to be present.

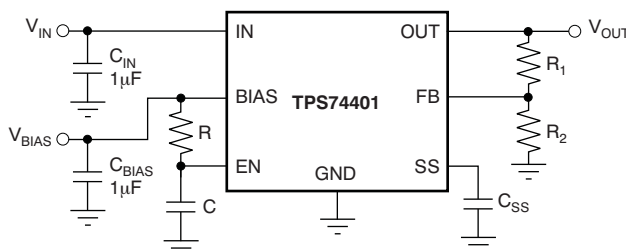

Figure 26. Soft-Start Delay Using an RC Circuit on Enable

If a signal is not available to enable the device after V_{IN} and V_{BIAS} , simply connecting V_{EN} to V_{IN} is acceptable for most applications as long as V_{IN} is greater than 1.1 V and the ramp rate of V_{IN} and V_{BIAS} is faster than the set soft-start ramp rate. If the ramp rate of the input sources is slower than the set soft-start time, the output tracks the slower supply less the dropout voltage until the set output voltage is reached. If V_{EN} is connected to V_{BIAS} , the device soft-starts as programmed, provided that V_{IN} is present before V_{BIAS} . If V_{BIAS} and V_{EN} are present before V_{IN} is applied and the set soft-start time has expired, then V_{OUT} tracks V_{IN} .

8 Application and Implementation

NOTE

Information in the following applications sections is not part of the TI component specification, and TI does not warrant its accuracy or completeness. TI's customers are responsible for determining suitability of components for their purposes. Customers should validate and test their design implementation to confirm system functionality.

8.1 Application Information

The TPS74401 belongs to a family of ultra-low dropout regulators that feature soft-start. These regulators use a low current bias input to power all internal control circuitry, allowing the NMOS pass transistor to regulate very low output voltages with low V_{IN} to V_{OUT} headroom.

The use of an NMOS-pass FET offers several critical advantages for many applications. Unlike a PMOS topology device, the output capacitor has little effect on loop stability. This architecture allows the TPS74401 to be stable with any or even no output capacitor. Transient response is also superior to PMOS topologies, particularly for low V_{IN} applications.

The TPS74401 features a programmable, voltage-controlled soft-start circuit that provides a smooth, monotonic start-up and limits startup inrush currents that can be caused by large capacitive loads. A power-good (PG) output is available to allow supply monitoring and sequencing of other supplies. An enable (EN) pin with hysteresis and de-glitch allows slow-ramping signals to be used for sequencing the device. The low V_{IN} and V_{OUT} capability allows for inexpensive, easy-to-design, and efficient linear regulation between the multiple supply voltages often present in processor intensive systems.

8.1.1 Input, Output, and Bias Capacitor Requirements

The TPS74401 does not require any output capacitor for stability. If an output capacitor is needed, the device is designed to be stable for all available types and values of output capacitance. The device is also stable with multiple capacitors in parallel, of any type or value. This flexibility is a result of an innovative control loop that ensures the device is stable independent of the output capacitance.

The capacitance required on the IN and BIAS pins strongly depends on the input supply source impedance. To counteract any inductance in the input, the minimum recommended capacitor for V_{IN} and V_{BIAS} is 1 μF . If V_{IN} and V_{BIAS} are connected to the same supply, the recommended minimum capacitor for V_{BIAS} is 4.7 μF . Use good quality, low-ESR capacitors on the input; ceramic X5R and X7R capacitors are preferred. Place these capacitors as close to the pins as possible for optimum performance and to help ensure stability.

8.1.2 Transient Response

The TPS74401 is designed to have transient response within 5% for most applications without an output capacitor. In some cases, the transient response can be limited by the transient response of the input supply. This limitation is especially true in applications where the difference between the input and output is less than 300 mV. In this case, adding additional input capacitance improves the transient response much more than just adding additional output capacitance. With a solid input supply, adding additional output capacitance reduces undershoot and overshoot during a transient at the expense of a slightly longer V_{OUT} recovery time; see [Figure 20](#) in the *Typical Characteristics* section. Because the TPS74401 is stable without an output capacitor, many applications can allow for little or no capacitance at the LDO output. For these applications, local bypass capacitance for the device under power can be sufficient to meet the transient requirements of the application. This design reduces the total solution cost by avoiding the need to use expensive, high-value capacitors at the LDO output.

Application Information (continued)

8.1.3 Dropout Voltage

The TPS74401 offers industry-leading dropout performance, making the device well-suited for high-current, low V_{IN} and low V_{OUT} applications. The extremely low dropout of the TPS74401 also allows the device to be used in place of a dc/dc converter and also achieve good efficiencies. Equation 3 provides a quick estimate of the efficiencies.

$$\text{Efficiency} \approx \frac{V_{OUT} \times I_{OUT}}{V_{IN} \times (I_{IN} + I_Q)} \approx \frac{V_{OUT}}{V_{IN}} \text{ at } I_{OUT} \gg I_Q \quad (3)$$

This efficiency allows users to redesign the power architecture for their applications to achieve the smallest, simplest, and lowest cost solution.

There are two different specifications for dropout voltage with the TPS74401. The first specification (see Figure 38) is referred to as V_{IN} Dropout and is for users who wish to apply an external bias voltage to achieve low dropout. This specification assumes that V_{BIAS} is at least 1.62 V above V_{OUT} ; for example, when V_{BIAS} is powered by a 3.3-V rail with 5% tolerance and with $V_{OUT} = 1.5$ V. If V_{BIAS} is higher than ($3.3 \text{ V} \times 0.95$) or V_{OUT} is less than 1.5 V, V_{IN} dropout is less than specified.

The second specification (see Figure 39) is referred to as V_{BIAS} Dropout and is for users who wish to have $V_{BIAS} < V_{IN} + 1.62$ V. This option allows the device to be used in applications where an auxiliary bias voltage is not available or low dropout is not required. Dropout is limited by BIAS in these applications because V_{BIAS} provides the gate drive to the pass FET and therefore must be greater than $V_{OUT} + V_{DO}(V_{BIAS})$. Because of this usage, IN and BIAS tied together easily consume excessive power. Pay attention and do not exceed the power rating of the IC package.

8.1.4 Output Noise

The TPS74401 provides low output noise when a soft-start capacitor is used. When the device reaches the end of the soft-start cycle, the soft-start capacitor serves as a filter for the internal reference. By using a 0.001- μ F soft-start capacitor, the output noise is reduced by half and is typically 19 μ V_{RMS} for a 1.2-V output (100 Hz to 100 kHz). Noise is a function of the set output voltage because most of the output noise is generated by the internal reference. The RMS noise with a 0.001- μ F soft-start capacitor is given in Equation 4.

$$V_N (\mu\text{V}_{RMS}) = 16 \left(\frac{\mu\text{V}_{RMS}}{V} \right) \times V_{OUT} (V) \quad (4)$$

The low output noise of the TPS74401 makes the device a good choice for powering transceivers, PLLs, or other noise-sensitive circuitry.

8.2 Typical Applications

8.2.1 Setting the TPS74401

Figure 27 shows a typical application circuit for the TPS74401.

R_1 and R_2 can be calculated for any output voltage using the formula shown in Figure 27. Table 3 lists sample resistor values of common output voltages. In order to achieve the maximum accuracy specifications, R_2 must be ≤ 4.99 k Ω .

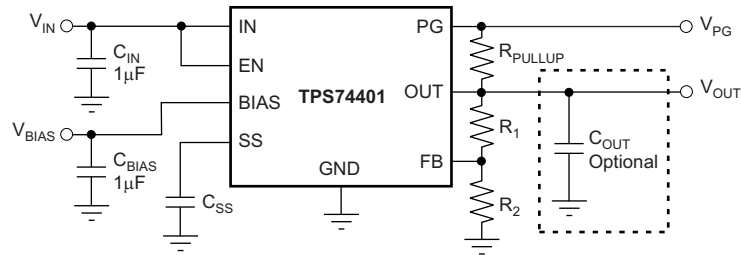

$$R_1 = \left[\frac{V_{OUT}}{V_{REF}} - 1 \right] \times R_2$$

Figure 27. Typical Application Circuit for the TPS74401

Table 3. Standard 1% Resistor Values for Programming the Output Voltage⁽¹⁾

R_1 (k Ω)	R_2 (k Ω)	V_{OUT} (V)
Short	Open	0.8
0.619	4.99	0.9
1.13	4.53	1.0
1.37	4.42	1.05
1.87	4.99	1.1
2.49	4.99	1.2
4.12	4.75	1.5
3.57	2.87	1.8
3.57	1.69	2.5
3.57	1.15	3.3

(1) $V_{OUT} = 0.8 \times (1 + R_1 / R_2)$.

NOTE

When V_{BIAS} and V_{EN} are present and V_{IN} is not supplied, this device outputs approximately 50 μ A of current from OUT. Although this condition does not cause any damage to the device, the output current can charge up the OUT node if total resistance between OUT and GND (including external feedback resistors) is greater than 10 k Ω .

8.2.1.1 Design Requirements

The design goals are $V_{IN} = 1.8\text{ V}$, $V_{OUT} = 1.5\text{ V}$, and $I_{OUT} = 2\text{ A}$ max. The design optimizes transient response while meeting a 1-ms startup time with a startup dominated by the soft-start feature. The input supply comes from a supply on the same circuit board. The available system rails for V_{BIAS} are 2.7 V, 3.3 V, and 5 V.

The design space consists of C_{IN} , C_{OUT} , C_{BIAS} , C_{SS} , V_{BIAS} , R_1 , R_2 , and R_3 , and the circuit is from [Figure 27](#).

This example uses a V_{IN} of 1.8 V, with a V_{BIAS} of 2.5 V.

8.2.1.2 Detailed Design Procedure

The first step for this design is to examine the maximum load current along with the input and output voltage requirements, to determine if the device thermal and dropout voltage requirements can be met. At 3 A, the input dropout voltage of the TPS74401 family is a maximum of 240 mV over temperature. As a result, the dropout headroom is sufficient for operation over both input and output voltage accuracy.

The maximum power dissipated in the linear regulator is the maximum voltage dropped across the pass element from the input to the output multiplied by the maximum load current. In this example, the maximum voltage drop across in the pass element is $(1.8\text{ V} - 1.5\text{ V})$, giving a $V_{DROP} = 300\text{ mV}$. The power dissipated can then be estimated by the equation $P_{DISS} = I_{L(max)} \times V_{DROP} = \sim 600\text{ mW}$. This calculation gives an efficiency of nearly 83.3% by using [Equation 3](#).

When the power dissipated in the linear regulator is known, the corresponding junction temperature increase can be calculated. To estimate the junction temperature increase above ambient, the power dissipated must be multiplied by the junction-to-ambient thermal resistance. For thermal resistance information, refer to the [Thermal Information](#) table. For this example, using the KTW package, the junction temperature rise is calculated to be 21.2°C. The maximum junction temperature increase is calculated by adding the junction temperature rise to the maximum ambient temperature. In this example, the maximum junction temperature is 46.2°C. Keep in mind that the junction temperature must be less than 125°C for reliable operation. Additional ground planes, added thermal vias, and air flow all help to improve the thermal transfer characteristics of the system.

The next step is to determine the bias voltage or if a separate source is needed for the bias voltage. Because V_{IN} is less than V_{OUT} plus the V_{BIAS} dropout, V_{BIAS} must be an independent supply. $V_{BIAS} = V_{OUT} + 1.62\text{ V} = 3.12\text{ V}$; the system has a 3.3-V rail to use for this supply and also to provide some limited headroom for V_{BIAS} . The 5-V rail is a better choice to improve the performance of the LDO, so the 5-V rail is used.

8.2.1.3 Application Curves

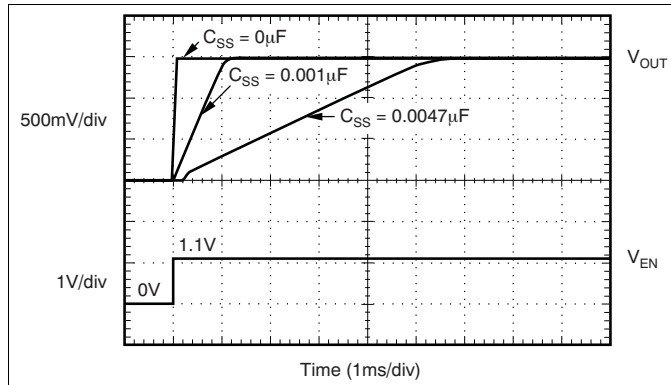

Figure 28. Turn-On Response

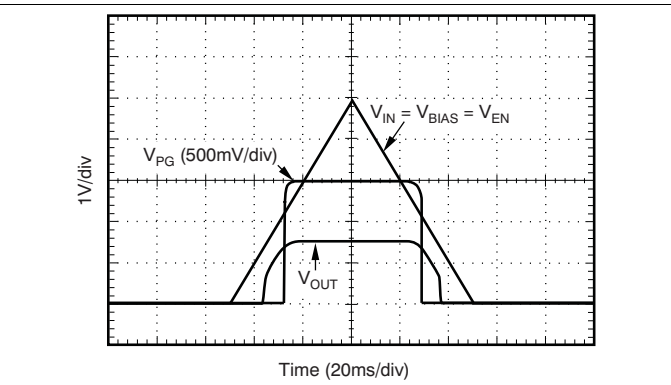

Figure 29. Power-Up, Power-Down

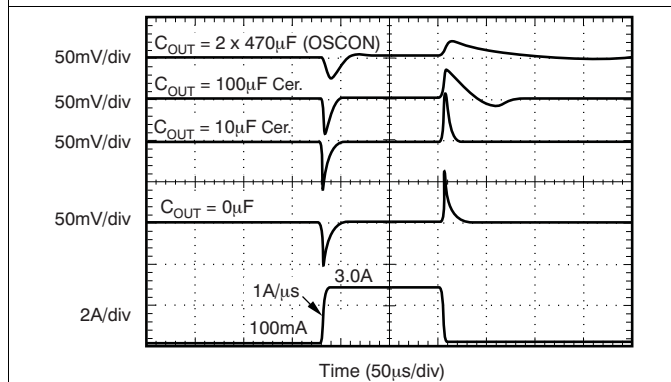

Figure 30. Load Transient Response

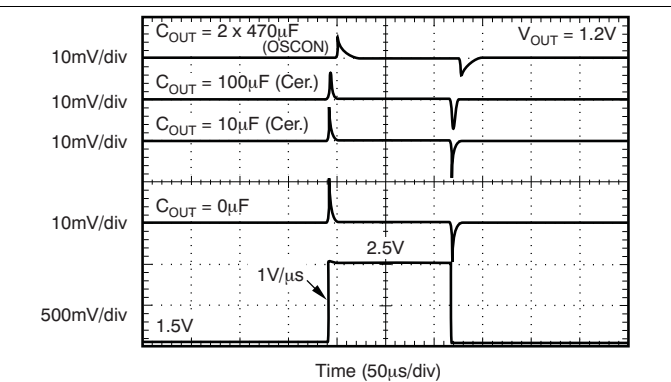

Figure 31. V_{IN} Line Transient (3 A)

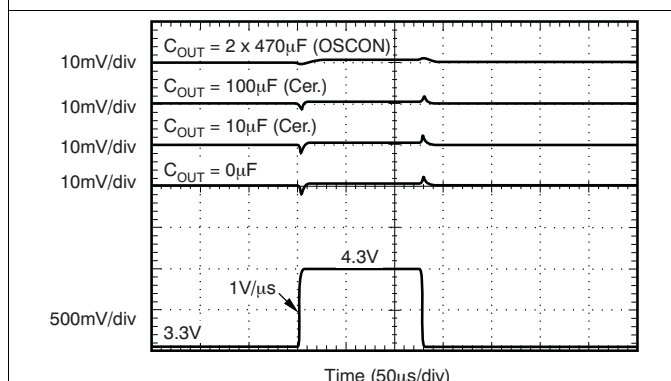

Figure 32. V_{BIAS} Line Transient (3 A)

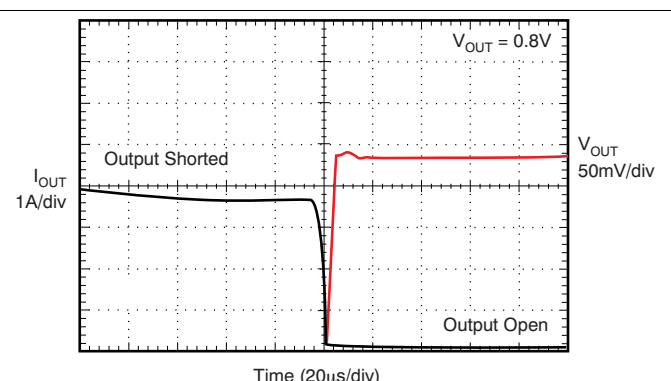

Figure 33. Output Short-Circuit Recovery

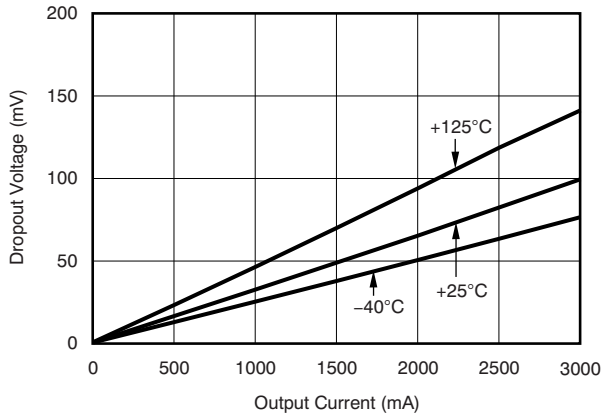

Figure 34. V_{IN} Dropout Voltage vs I_{OUT} and Temperature (T_J)

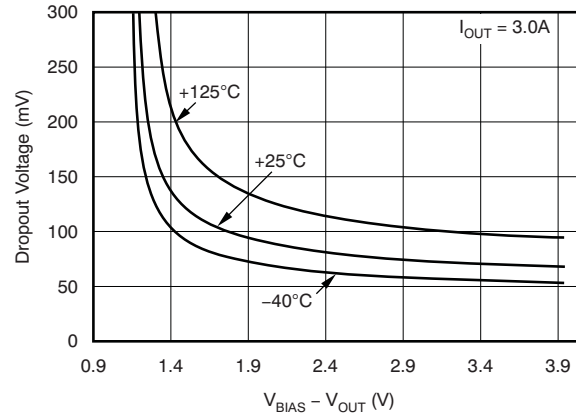

Figure 35. V_{IN} Dropout Voltage vs $V_{BIAS} - V_{OUT}$ and Temperature (T_J)

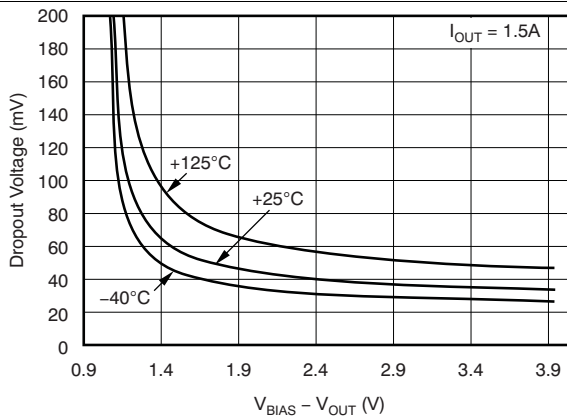

Figure 36. V_{IN} Dropout Voltage vs $V_{BIAS} - V_{OUT}$ and Temperature (T_J)

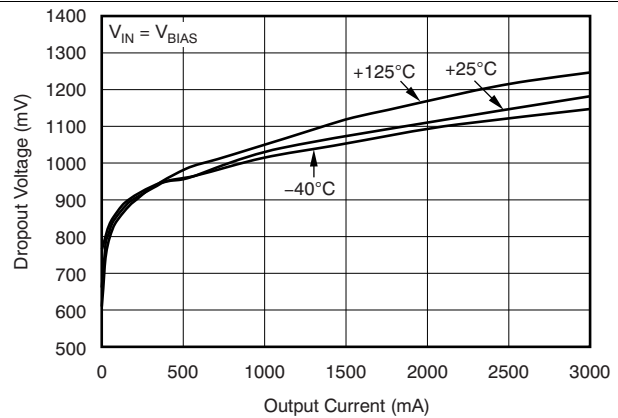

Figure 37. V_{BIAS} Dropout Voltage vs I_{OUT} and Temperature (T_J)

8.2.2 Using an Auxiliary Bias Rail

Figure 38 shows a typical application of the TPS74401 using an auxiliary bias rail. The auxiliary bias rail allows for the designer to specify the system to have a low V_{DO} . The bias rail supplies the error amplifier with a higher supply voltage, increasing the voltage that can be applied to the gate of the pass device.

V_{BIAS} must be at least $V_{OUT} + 1.62 V$.

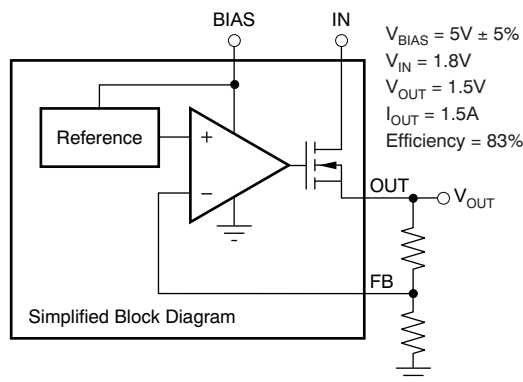

Figure 38. Typical Application of the TPS74401 Using an Auxiliary Bias Rail

8.2.3 Without an Auxiliary Bias

The TPS74401 family is capable of operating without a bias rail if $V_{IN} \geq V_{OUT} + V_{DO}$ (V_{BIAS}). Additional capacitance is advised for this scenario, with at least 4.7 μF of capacitance near the input pin. Figure 39 shows a typical application of the TPS74401 without an auxiliary bias.

If using the TPS74401 in this situation and under high load conditions, ensure that the printed circuit board (PCB) provides adequate thermal handling capabilities to keep the device in its recommended operating range. See the [Power Supply Recommendations](#) section for more information.

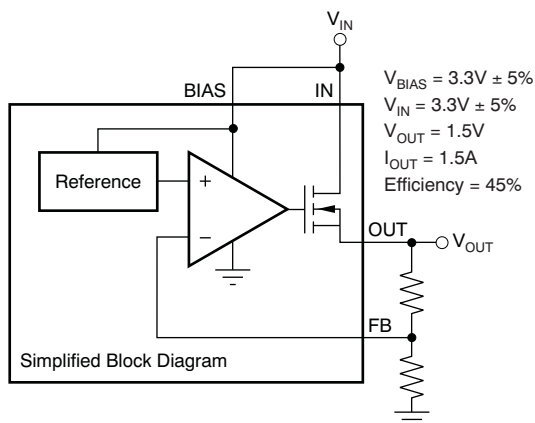

Figure 39. Typical Application of the TPS74401 Without an Auxiliary Bias

9 Power Supply Recommendations

The TPS74401 is designed to operate from an input voltage between 1.1 V to 5.5 V, provided the bias rail is at least 1.62 V higher than the input supply. The bias rail and the input supply must both provide adequate headroom and current for the device to operate normally.

Connect a low output impedance power supply directly to the IN pin of the TPS74401. This supply must have at least 1 μF of capacitance near the IN pin for stability. A supply with similar requirements must also be connected directly to the bias rail with a separate 1 μF or larger capacitor.

If the IN pin is tied to the bias pin, a minimum 4.7 μF of capacitance is needed for stability.

To increase the overall PSRR of the solution at higher frequencies, use a pi-filter or ferrite bead before the input capacitor.

10 Layout

10.1 Layout Guidelines

An optimal layout can greatly improve transient performance, PSRR, and noise. To minimize the voltage droop on the input of the device during load transients, connect the capacitance on IN and BIAS as close as possible to the device. This capacitance also minimizes the effects of parasitic inductance and resistance of the input source and can therefore improve stability. To achieve optimal transient performance and accuracy, connect the top side of R₁ in Figure 27 as close as possible to the load. This connection minimizes the voltage droop on BIAS during transient conditions and can improve the turn-on response.

10.2 Layout Example

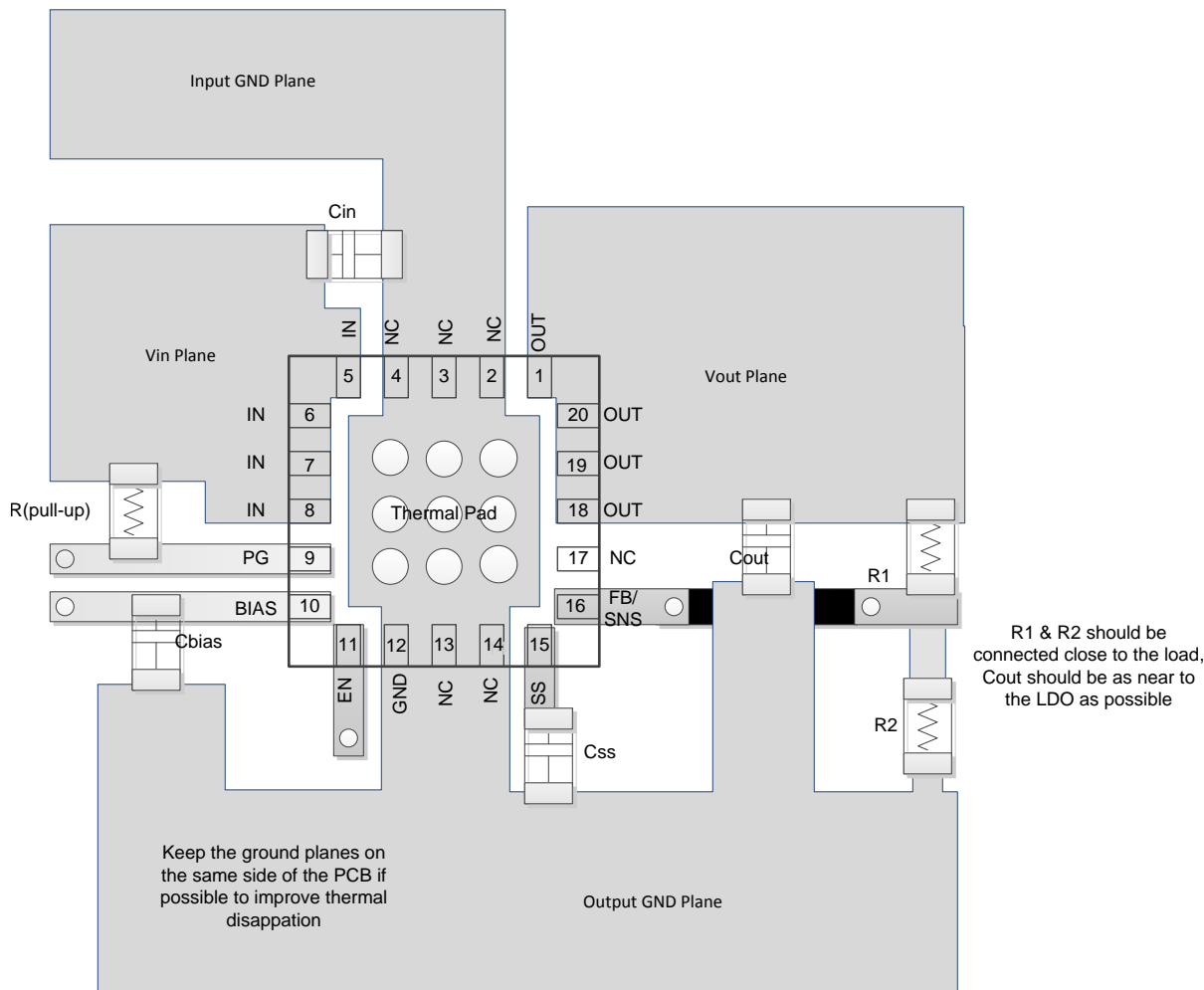

Figure 40. Layout Schematic (VQFN Packages)

10.3 Power Dissipation

Knowing the device power dissipation and proper sizing of the thermal plane that is connected to the tab or pad is critical to avoiding thermal shutdown and ensuring reliable operation.

Power dissipation of the device depends on input voltage and load conditions, and can be calculated using Equation 5:

$$P_D = (V_{IN} - V_{OUT}) \times I_{OUT} \quad (5)$$

Power Dissipation (continued)

Power dissipation can be minimized and greater efficiency can be achieved by using the lowest possible input voltage necessary to achieve the required output voltage regulation.

On the VQFN (RGW, RGR) packages, the primary conduction path for heat is through the exposed pad to the PCB. The pad can be connected to ground or left floating; however, the pad must be attached to an appropriate amount of copper PCB area to ensure the device does not overheat. On the DDPAK (KTW) package, the primary conduction path for heat is through the tab to the PCB. Connect that tab to ground. The maximum junction-to-ambient thermal resistance depends on the maximum ambient temperature, maximum device junction temperature, and power dissipation of the device and can be estimated using Equation 6:

$$R_{\theta JA} = \frac{(+125^{\circ}\text{C} - T_A)}{P_D} \tag{6}$$

Knowing the maximum $R_{\theta JA}$, the minimum amount of PCB copper area needed for appropriate heatsinking can be estimated using Figure 41.

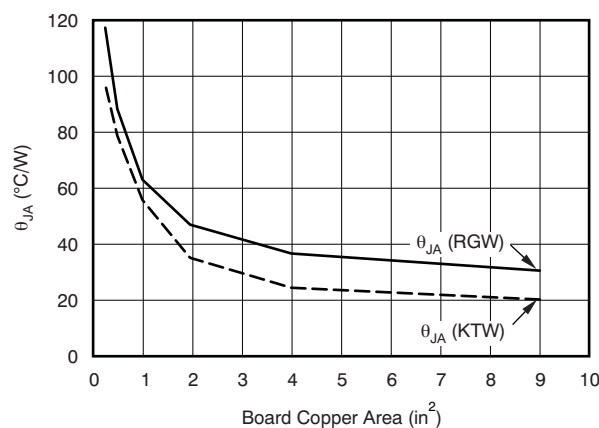

Note: θ_{JA} value at board size of 9 in² (that is, 3 in x 3 in) is a JEDEC standard.

Figure 41. θ_{JA} versus Board Size

Figure 41 shows the variation of θ_{JA} as a function of ground plane copper area in the board. Figure 41 is intended only as a guideline to demonstrate the affects of heat spreading in the ground plane; do not use Figure 41 to estimate actual thermal performance in real application environments.

NOTE

When the device is mounted on an application PCB, TI strongly recommends using Ψ_{JT} and Ψ_{JB} , as explained in the section.

10.4 Thermal Considerations

A better method of estimating the thermal measure comes from using the thermal metrics Ψ_{JT} and Ψ_{JB} , as shown in *Thermal Information*. These metrics are a more accurate representation of the heat transfer characteristics of the die and the package than $R_{\theta JA}$. The junction temperature can be estimated with the corresponding formulas given in Equation 7.

$$\Psi_{JT}: T_J = T_T + \Psi_{JT} \cdot P_D$$

$$\Psi_{JB}: T_J = T_B + \Psi_{JB} \cdot P_D$$

where

- P_D is the power dissipation shown by Equation 5,
 - T_T is the temperature at the center-top of the IC package, and
 - T_B is the PCB temperature measured 1 mm away from the IC package on the PCB surface (see Figure 42).
- (7)

Thermal Considerations (continued)

NOTE

Both T_T and T_B can be measured on actual application boards using a thermo-gun (an infrared thermometer).

For more information about measuring T_T and T_B , see the application note *Using New Thermal Metrics (SBVA025)*, available for download at www.ti.com.

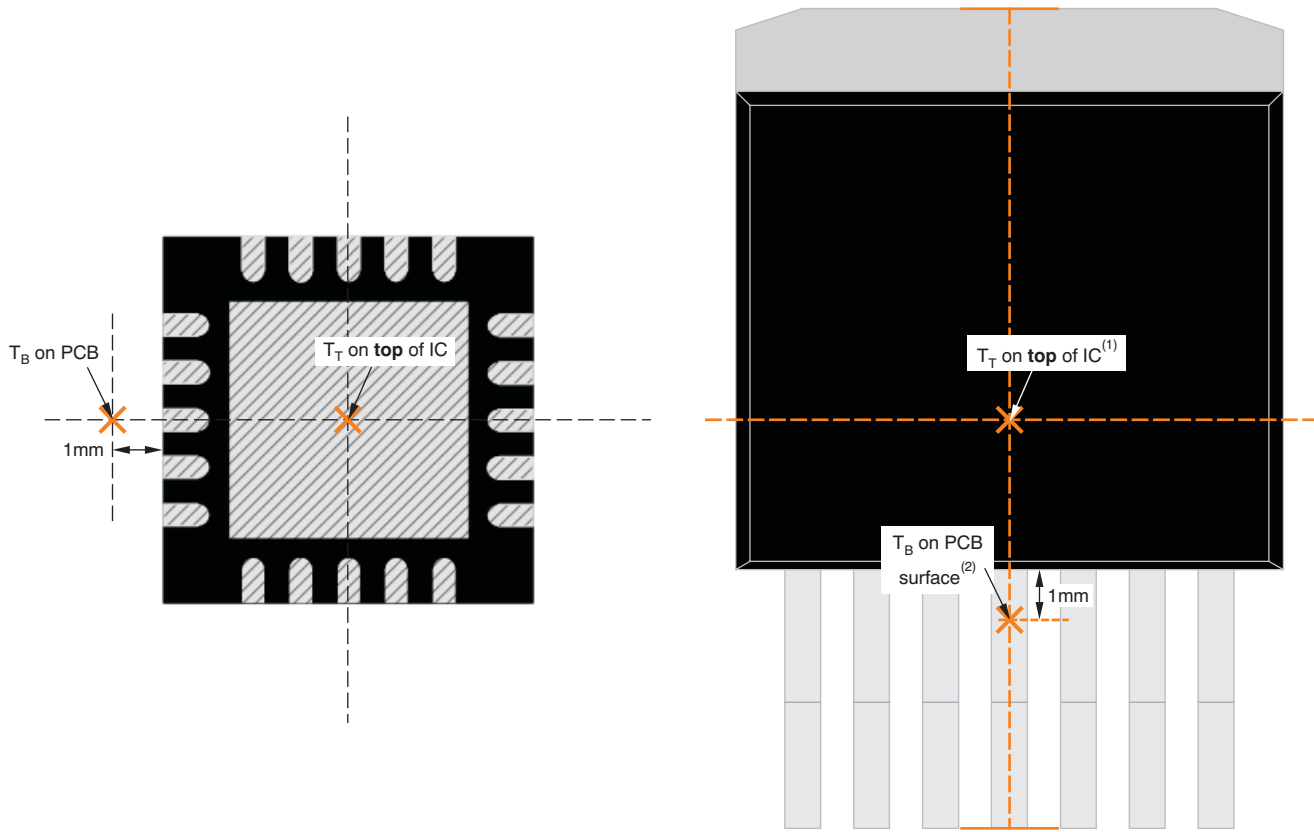

(a) Example RGW (QFN) Package Measurement

(b) Example KTW (DDPAK) Package Measurement

- (1) T_T is measured at the center of both the X- and Y-dimensional axes.
- (2) T_B is measured **below** the package lead **on the PCB surface**.

Figure 42. Measuring Points for T_T and T_B

Compared with θ_{JA} , the thermal metrics Ψ_{JT} and Ψ_{JB} are less independent of board size, but do have a small dependency on board size and layout. **Figure 43** shows characteristic performance of Ψ_{JT} and Ψ_{JB} versus board size.

Referring to **Figure 43**, the RGW package thermal performance has negligible dependency on board size. The KTW package, however, does have a measurable dependency on board size. This dependency exists because the package shape is not point symmetric to an IC center. In the KTW package, for example (see **Figure 42**), silicon is not beneath the measuring point of T_T which is the center of the X and Y dimension, so that Ψ_{JT} has a dependency. Also, because of that non-point symmetry, device heat distribution on the PCB is not point symmetric either, so that Ψ_{JB} has a greater dependency on board size and layout.

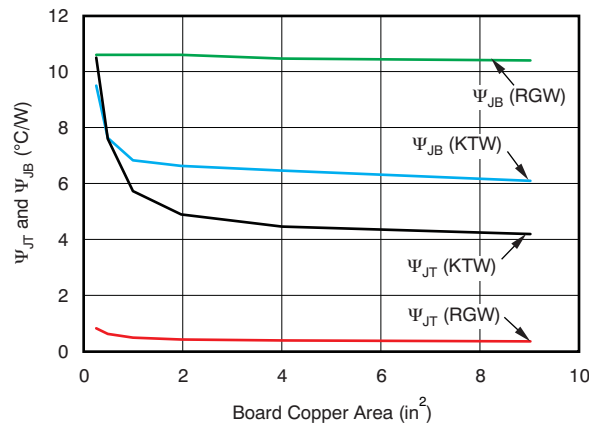

Figure 43. Ψ_{JT} and Ψ_{JB} versus Board Size

For a more detailed discussion of why TI does not recommend using $\theta_{JC(top)}$ to determine thermal characteristics, refer to the application note *Using New Thermal Metrics* (**SBVA025**), available for download at www.ti.com. Also, refer to the application note *IC Package Thermal Metrics* (**SPRA953**) (also available on the TI website) for further information.

11 Device and Documentation Support

11.1 Device Support

11.1.1 Development Support

11.1.1.1 Evaluation Modules

An evaluation module (EVM) is available to assist in the initial circuit performance evaluation using the TPS74401. The [TPS74401EVM-118 evaluation module](#) (and [related user guide](#)) can be requested at the Texas Instruments website through the product folders or purchased directly from the [TI eStore](#).

11.1.1.2 Spice Models

Computer simulation of circuit performance using SPICE is often useful when analyzing the performance of analog circuits and systems. A SPICE model for the TPS74401 is available through the product folders under *Tools & Software*.

11.2 Documentation Support

11.2.1 Related Documentation

For related documentation see the following:

- [6A Current-Sharing Dual LDO reference design](#)
- [Using New Thermal Metrics application report](#)
- [IC Package Thermal Metrics application report](#)
- [TPS74401EVM-118 Evaluation Module User Guide](#)

11.3 Receiving Notification of Documentation Updates

To receive notification of documentation updates, navigate to the device product folder on ti.com. In the upper right corner, click on *Alert me* to register and receive a weekly digest of any product information that has changed. For change details, review the revision history included in any revised document.

11.4 Community Resources

The following links connect to TI community resources. Linked contents are provided "AS IS" by the respective contributors. They do not constitute TI specifications and do not necessarily reflect TI's views; see TI's [Terms of Use](#).

TI E2E™ Online Community *TI's Engineer-to-Engineer (E2E) Community*. Created to foster collaboration among engineers. At e2e.ti.com, you can ask questions, share knowledge, explore ideas and help solve problems with fellow engineers.

Design Support *TI's Design Support* Quickly find helpful E2E forums along with design support tools and contact information for technical support.

11.5 Trademarks

E2E is a trademark of Texas Instruments.
All other trademarks are the property of their respective owners.

11.6 Electrostatic Discharge Caution



This integrated circuit can be damaged by ESD. Texas Instruments recommends that all integrated circuits be handled with appropriate precautions. Failure to observe proper handling and installation procedures can cause damage.

ESD damage can range from subtle performance degradation to complete device failure. Precision integrated circuits may be more susceptible to damage because very small parametric changes could cause the device not to meet its published specifications.

11.7 Glossary

SLYZ022 — *TI Glossary*.

This glossary lists and explains terms, acronyms, and definitions.

12 Mechanical, Packaging, and Orderable Information

The following pages include mechanical, packaging, and orderable information. This information is the most current data available for the designated devices. This data is subject to change without notice and revision of this document. For browser-based versions of this data sheet, refer to the left-hand navigation.

PACKAGING INFORMATION

Orderable Device	Status (1)	Package Type	Package Drawing	Pins	Package Qty	Eco Plan (2)	Lead finish/ Ball material (6)	MSL Peak Temp (3)	Op Temp (°C)	Device Marking (4/5)	Samples
TPS74401KTWR	ACTIVE	DDPAK/ TO-263	KTW	7	500	RoHS & Green	Call TI SN	Level-3-245C-168 HR	-40 to 125	TPS74401	Samples
TPS74401KTWRG3	ACTIVE	DDPAK/ TO-263	KTW	7	500	RoHS & Green	SN	Level-3-245C-168 HR	-40 to 125	TPS74401	Samples
TPS74401RGRR	ACTIVE	VQFN	RGR	20	3000	RoHS & Green	NIPDAU	Level-2-260C-1 YEAR	-40 to 125	12KA	Samples
TPS74401RGWR	ACTIVE	VQFN	RGW	20	3000	RoHS & Green	NIPDAU	Level-2-260C-1 YEAR	-40 to 125	TPS 74401	Samples
TPS74401RGWRG4	ACTIVE	VQFN	RGW	20	3000	RoHS & Green	NIPDAU	Level-2-260C-1 YEAR	-40 to 125	TPS 74401	Samples
TPS74401RGWT	ACTIVE	VQFN	RGW	20	250	RoHS & Green	NIPDAU	Level-2-260C-1 YEAR	-40 to 125	TPS 74401	Samples
TPS74401RGWTG4	ACTIVE	VQFN	RGW	20	250	RoHS & Green	NIPDAU	Level-2-260C-1 YEAR	-40 to 125	TPS 74401	Samples

(1) The marketing status values are defined as follows:

ACTIVE: Product device recommended for new designs.

LIFEBUY: TI has announced that the device will be discontinued, and a lifetime-buy period is in effect.

NRND: Not recommended for new designs. Device is in production to support existing customers, but TI does not recommend using this part in a new design.

PREVIEW: Device has been announced but is not in production. Samples may or may not be available.

OBSOLETE: TI has discontinued the production of the device.

(2) **RoHS:** TI defines "RoHS" to mean semiconductor products that are compliant with the current EU RoHS requirements for all 10 RoHS substances, including the requirement that RoHS substance do not exceed 0.1% by weight in homogeneous materials. Where designed to be soldered at high temperatures, "RoHS" products are suitable for use in specified lead-free processes. TI may reference these types of products as "Pb-Free".

RoHS Exempt: TI defines "RoHS Exempt" to mean products that contain lead but are compliant with EU RoHS pursuant to a specific EU RoHS exemption.

Green: TI defines "Green" to mean the content of Chlorine (Cl) and Bromine (Br) based flame retardants meet JS709B low halogen requirements of <=1000ppm threshold. Antimony trioxide based flame retardants must also meet the <=1000ppm threshold requirement.

(3) MSL, Peak Temp. - The Moisture Sensitivity Level rating according to the JEDEC industry standard classifications, and peak solder temperature.

(4) There may be additional marking, which relates to the logo, the lot trace code information, or the environmental category on the device.

(5) Multiple Device Markings will be inside parentheses. Only one Device Marking contained in parentheses and separated by a "~" will appear on a device. If a line is indented then it is a continuation of the previous line and the two combined represent the entire Device Marking for that device.

⁽⁶⁾ Lead finish/Ball material - Orderable Devices may have multiple material finish options. Finish options are separated by a vertical ruled line. Lead finish/Ball material values may wrap to two lines if the finish value exceeds the maximum column width.

Important Information and Disclaimer:The information provided on this page represents TI's knowledge and belief as of the date that it is provided. TI bases its knowledge and belief on information provided by third parties, and makes no representation or warranty as to the accuracy of such information. Efforts are underway to better integrate information from third parties. TI has taken and continues to take reasonable steps to provide representative and accurate information but may not have conducted destructive testing or chemical analysis on incoming materials and chemicals. TI and TI suppliers consider certain information to be proprietary, and thus CAS numbers and other limited information may not be available for release.

In no event shall TI's liability arising out of such information exceed the total purchase price of the TI part(s) at issue in this document sold by TI to Customer on an annual basis.

OTHER QUALIFIED VERSIONS OF TPS74401 :

- Enhanced Product : [TPS74401-EP](#)

NOTE: Qualified Version Definitions:

- Enhanced Product - Supports Defense, Aerospace and Medical Applications

TAPE AND REEL INFORMATION

QUADRANT ASSIGNMENTS FOR PIN 1 ORIENTATION IN TAPE

*All dimensions are nominal

Device	Package Type	Package Drawing	Pins	SPQ	Reel Diameter (mm)	Reel Width W1 (mm)	A0 (mm)	B0 (mm)	K0 (mm)	P1 (mm)	W (mm)	Pin1 Quadrant
TPS74401RGRR	VQFN	RGR	20	3000	330.0	12.4	3.8	3.8	1.1	8.0	12.0	Q1
TPS74401RGRT	VQFN	RGR	20	250	180.0	12.5	3.8	3.8	1.1	8.0	12.0	Q1
TPS74401RGWR	VQFN	RGW	20	3000	330.0	12.4	5.3	5.3	1.1	8.0	12.0	Q2
TPS74401RGWT	VQFN	RGW	20	250	180.0	12.4	5.3	5.3	1.1	8.0	12.0	Q2

TAPE AND REEL BOX DIMENSIONS



*All dimensions are nominal

Device	Package Type	Package Drawing	Pins	SPQ	Length (mm)	Width (mm)	Height (mm)
TPS74401RGRR	VQFN	RGR	20	3000	338.0	355.0	50.0
TPS74401RGRT	VQFN	RGR	20	250	338.0	355.0	50.0
TPS74401RGWR	VQFN	RGW	20	3000	367.0	367.0	35.0
TPS74401RGWT	VQFN	RGW	20	250	210.0	185.0	35.0

GENERIC PACKAGE VIEW

RGW 20

VQFN - 1 mm max height

5 x 5, 0.65 mm pitch

PLASTIC QUAD FLATPACK - NO LEAD

This image is a representation of the package family, actual package may vary.
Refer to the product data sheet for package details.

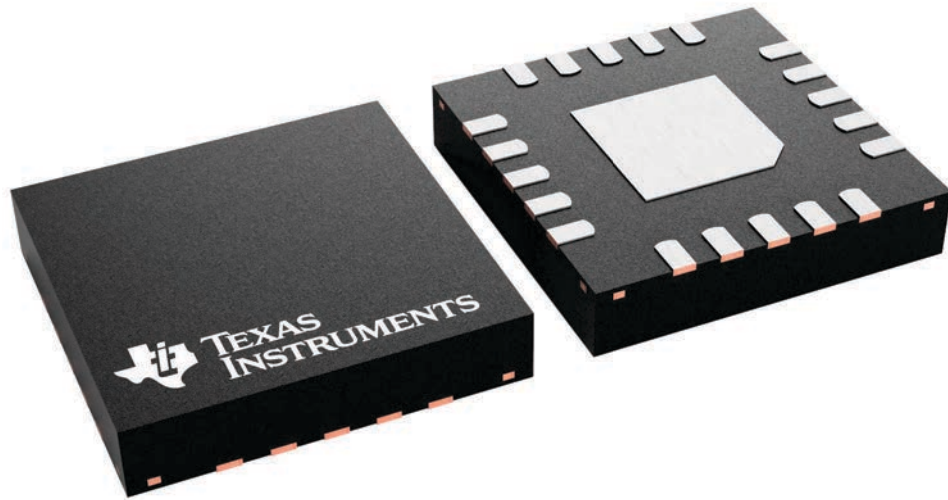

4227157/A

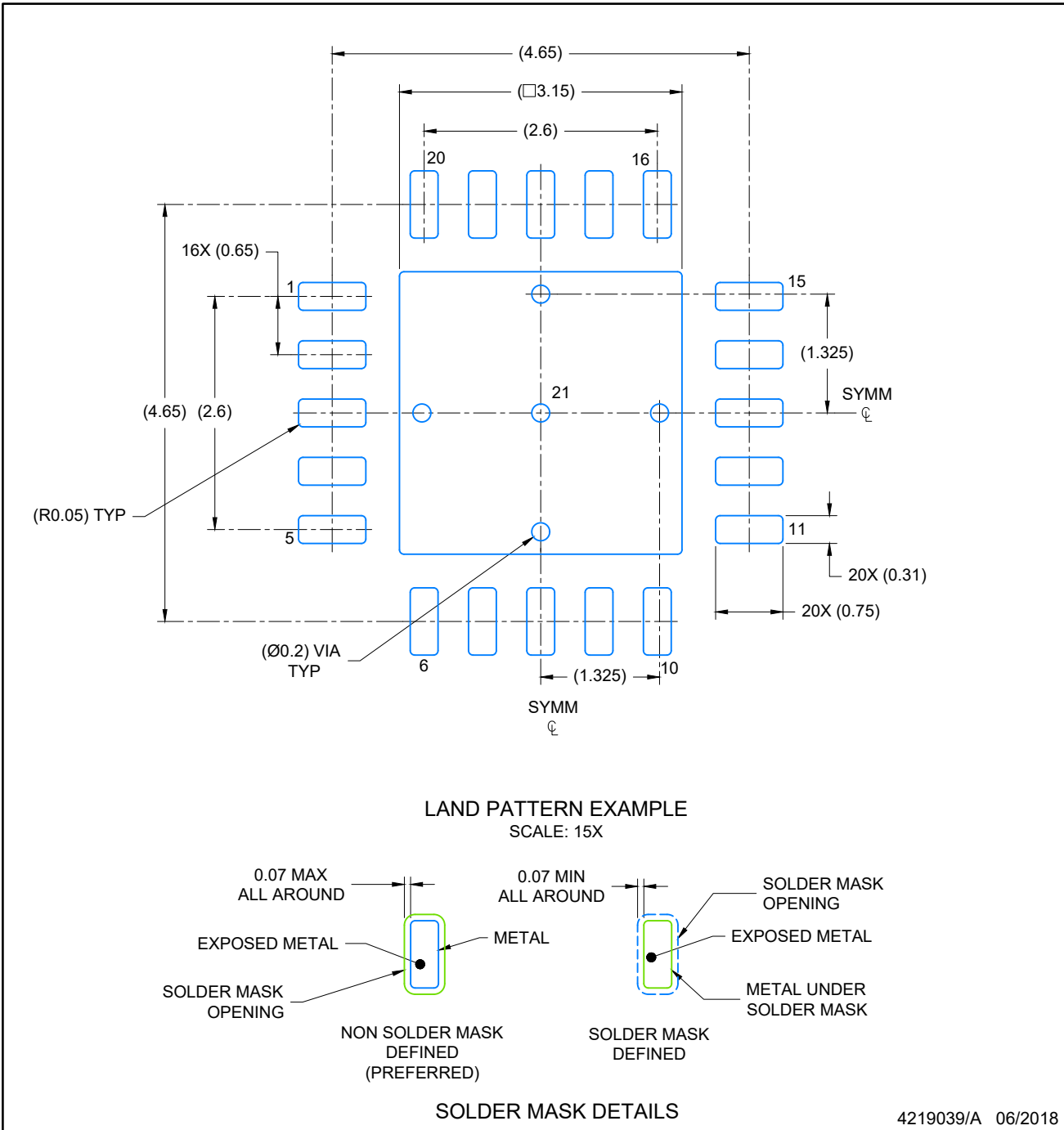

4219039/A 06/2018

NOTES: (continued)

4. This package is designed to be soldered to a thermal pad on the board. For more information, see Texas Instruments literature number SLUA271 (www.ti.com/lit/sluea271).
5. Vias are optional depending on application, refer to device data sheet. If any vias are implemented, refer to their locations shown on this view. It is recommended that vias under paste be filled, plugged or tented.

EXAMPLE STENCIL DESIGN

VQFN - 1 mm max height

RGW0020A

PLASTIC QUAD FLATPACK-NO LEAD

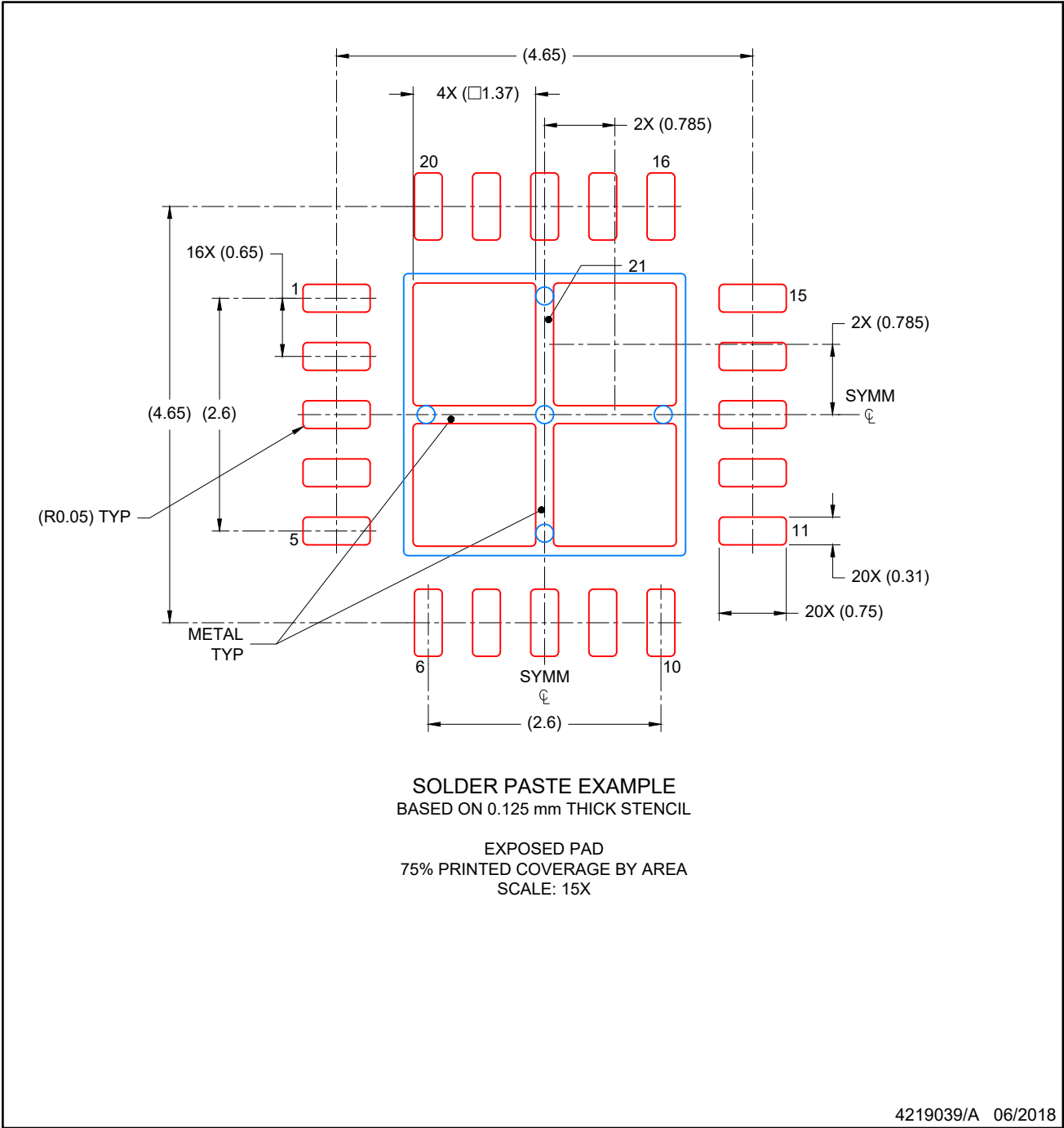

NOTES: (continued)

- 6. Laser cutting apertures with trapezoidal walls and rounded corners may offer better paste release. IPC-7525 may have alternate design recommendations.

GENERIC PACKAGE VIEW

RGR 20

VQFN - 1 mm max height

3.5 x 3.5, 0.5 mm pitch

PLASTIC QUAD FLATPACK - NO LEAD

This image is a representation of the package family, actual package may vary.
Refer to the product data sheet for package details.

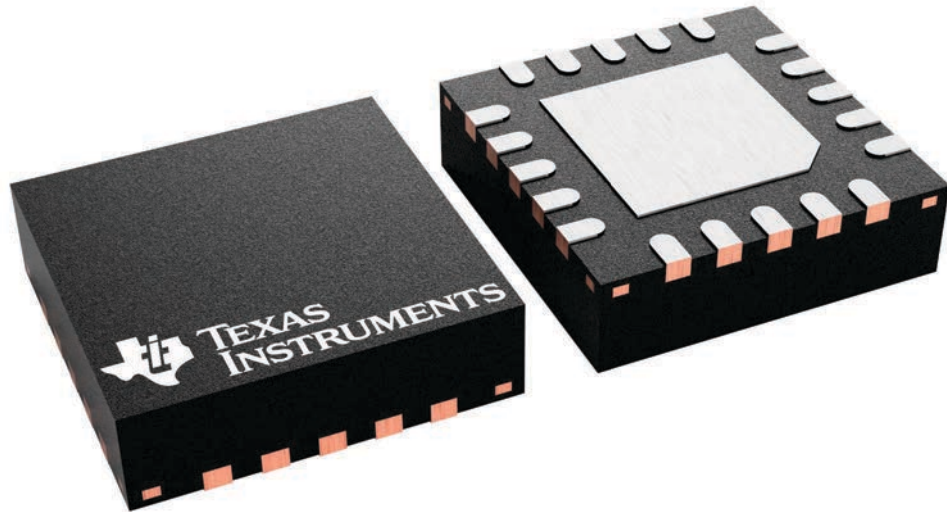

4228482/A

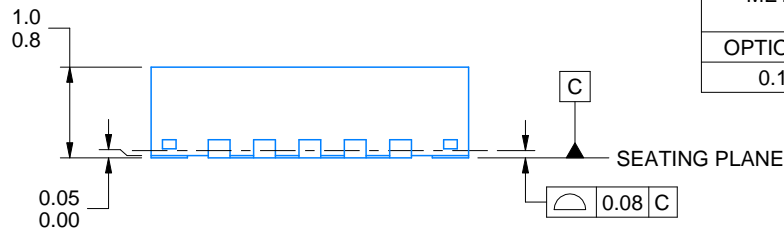
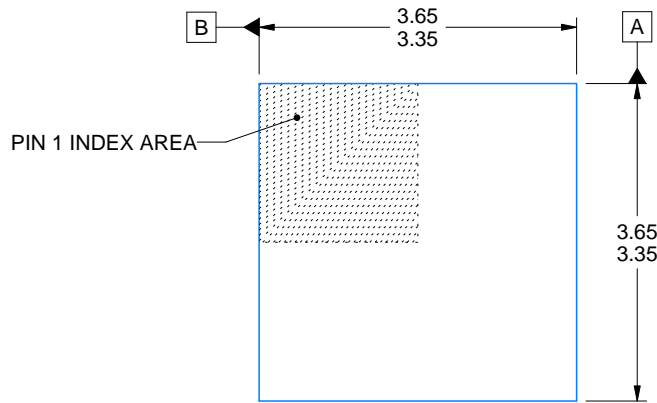

SIDE WALL METAL THICKNESS DIM A	
OPTION 1	OPTION 2
0.1	0.2

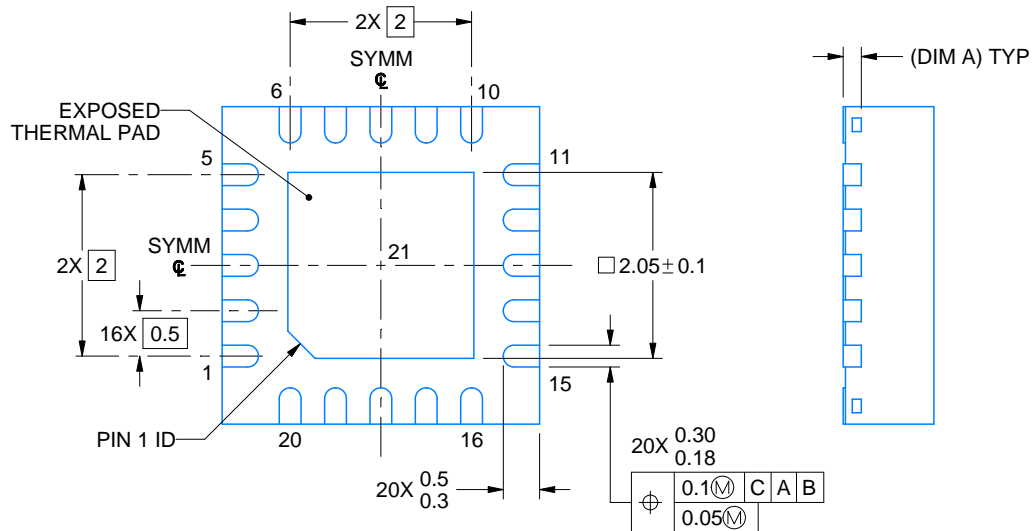

4219031/B 04/2022

NOTES:

1. All linear dimensions are in millimeters. Any dimensions in parenthesis are for reference only. Dimensioning and tolerancing per ASME Y14.5M.
2. This drawing is subject to change without notice.
3. The package thermal pad must be soldered to the printed circuit board for thermal and mechanical performance.

EXAMPLE BOARD LAYOUT

RGR0020A

VQFN - 1 mm max height

PLASTIC QUAD FLATPACK - NO LEAD

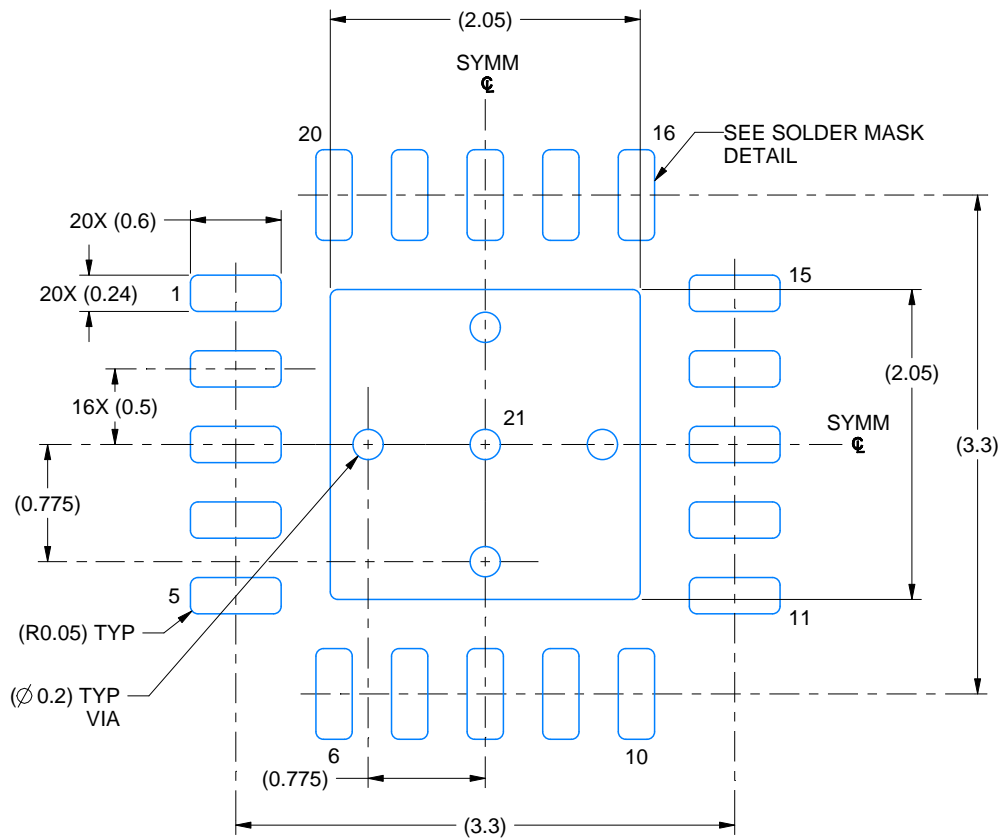

LAND PATTERN EXAMPLE
EXPOSED METAL SHOWN
SCALE: 20X

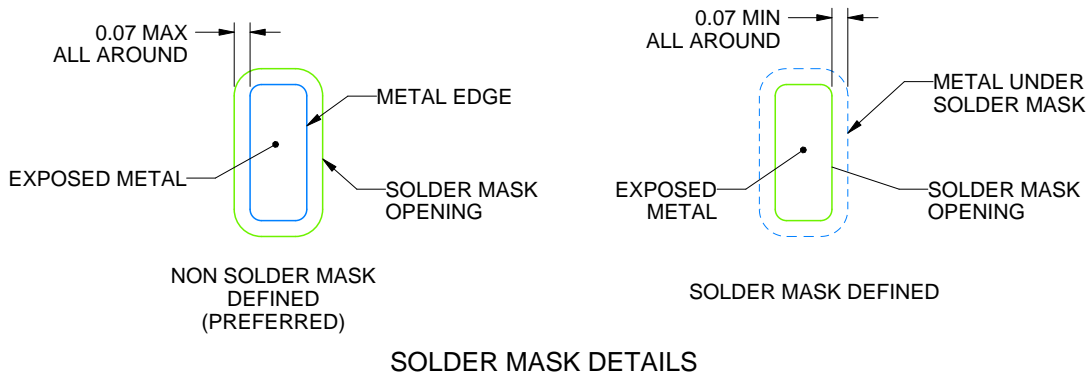

4219031/B 04/2022

NOTES: (continued)

- This package is designed to be soldered to a thermal pad on the board. For more information, see Texas Instruments literature number SLUA271 (www.ti.com/lit/sluea271).
- Vias are optional depending on application, refer to device data sheet. If any vias are implemented, refer to their locations shown on this view. It is recommended that vias under paste be filled, plugged or tented.

EXAMPLE STENCIL DESIGN

RGR0020A

VQFN - 1 mm max height

PLASTIC QUAD FLATPACK - NO LEAD

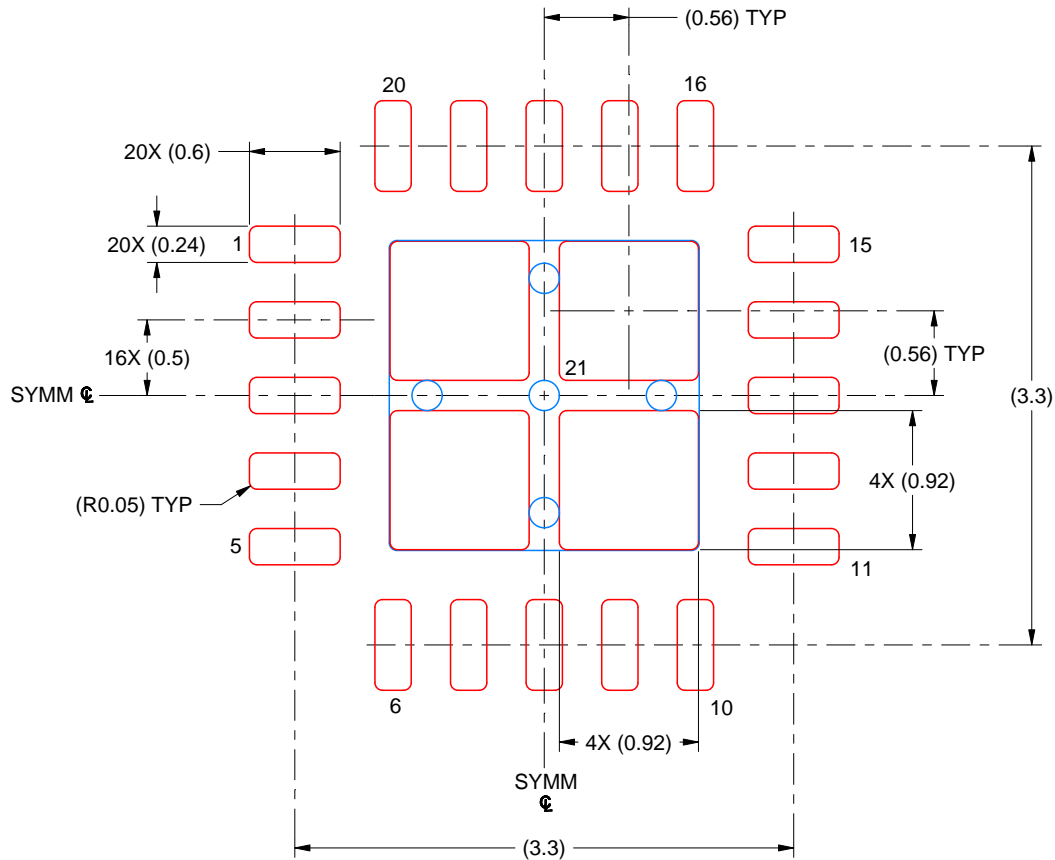

SOLDER PASTE EXAMPLE
BASED ON 0.125 MM THICK STENCIL
SCALE: 20X

EXPOSED PAD 21
81% PRINTED SOLDER COVERAGE BY AREA UNDER PACKAGE

4219031/B 04/2022

NOTES: (continued)

6. Laser cutting apertures with trapezoidal walls and rounded corners may offer better paste release. IPC-7525 may have alternate design recommendations.

KTW (R-PSFM-G7)

PLASTIC FLANGE-MOUNT

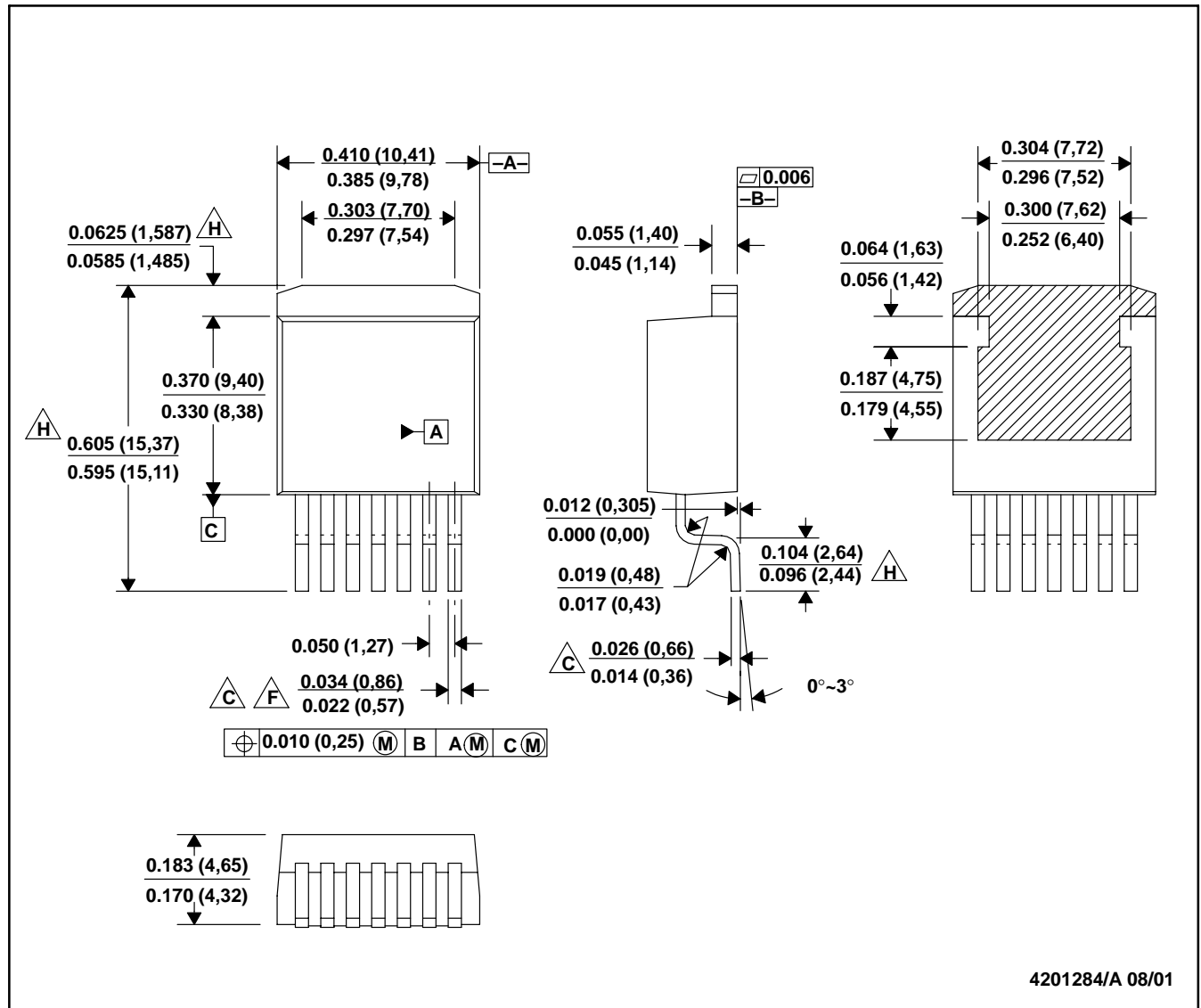

4201284/A 08/01

- NOTES:
- All linear dimensions are in inches (millimeters).
 - This drawing is subject to change without notice.
 - $\triangle C$ Lead width and height dimensions apply to the plated lead.
 - Leads are not allowed above the Datum B.
 - Stand-off height is measured from lead tip with reference to Datum B.
 - $\triangle F$ Lead width dimension does not include dambar protrusion. Allowable dambar protrusion shall not cause the lead width to exceed the maximum dimension by more than 0.003".
 - Cross-hatch indicates exposed metal surface.
 - $\triangle H$ Falls within JEDEC MO-169 with the exception of the dimensions indicated.

IMPORTANT NOTICE AND DISCLAIMER

TI PROVIDES TECHNICAL AND RELIABILITY DATA (INCLUDING DATA SHEETS), DESIGN RESOURCES (INCLUDING REFERENCE DESIGNS), APPLICATION OR OTHER DESIGN ADVICE, WEB TOOLS, SAFETY INFORMATION, AND OTHER RESOURCES "AS IS" AND WITH ALL FAULTS, AND DISCLAIMS ALL WARRANTIES, EXPRESS AND IMPLIED, INCLUDING WITHOUT LIMITATION ANY IMPLIED WARRANTIES OF MERCHANTABILITY, FITNESS FOR A PARTICULAR PURPOSE OR NON-INFRINGEMENT OF THIRD PARTY INTELLECTUAL PROPERTY RIGHTS.

These resources are intended for skilled developers designing with TI products. You are solely responsible for (1) selecting the appropriate TI products for your application, (2) designing, validating and testing your application, and (3) ensuring your application meets applicable standards, and any other safety, security, regulatory or other requirements.

These resources are subject to change without notice. TI grants you permission to use these resources only for development of an application that uses the TI products described in the resource. Other reproduction and display of these resources is prohibited. No license is granted to any other TI intellectual property right or to any third party intellectual property right. TI disclaims responsibility for, and you will fully indemnify TI and its representatives against, any claims, damages, costs, losses, and liabilities arising out of your use of these resources.

TI's products are provided subject to [TI's Terms of Sale](#) or other applicable terms available either on [ti.com](https://www.ti.com) or provided in conjunction with such TI products. TI's provision of these resources does not expand or otherwise alter TI's applicable warranties or warranty disclaimers for TI products.

TI objects to and rejects any additional or different terms you may have proposed.

Mailing Address: Texas Instruments, Post Office Box 655303, Dallas, Texas 75265
Copyright © 2024, Texas Instruments Incorporated

Looking for pricing, stock, or lifecycle information?

Click below to explore more details on WIN SOURCE:

 [View TPS74401KTWR on WIN SOURCE](#)

 [Texas Instruments](#) Information

Optimize Your Supply Chain with WIN SOURCE Solutions

-  Global Sourcing Solution
-  Obsolete Management
-  Cost Control Management
-  Shortage Management
-  Alternative Solution
-  Excess Inventory Management