



**THE DATASHEET OF
TPS7A7300RGWR**



TPS7A7300 3-A, Fast-Transient, Low-Dropout Voltage Regulator

1 Features

- Low-dropout voltage: 240 mV at 3 A
- V_{IN} range: 1.5 V to 6.5 V
- Configurable fixed V_{OUT} range: 0.9 V to 3.5 V
- Adjustable V_{OUT} range: 0.9 V to 5 V
- Very good load- and line-transient response
- Stable with ceramic output capacitor
- 2% accuracy overline, overload, and overtemperature
- Programmable soft-start
- Power-good (PG) output
- Package: 5-mm × 5-mm, 20-pin VQFN

2 Applications

- [Wireless infrastructure](#)
- [RF components](#)
- [Set-top boxes](#)
- [PCs and printers](#)
- [Audio and visual](#)

3 Description

The TPS7A7300 low-dropout (LDO) voltage regulator is designed for applications requiring very-low dropout capability (240 mV at 3 A) with an input voltage from 1.5 V to 6.5 V. The TPS7A7300 offers an innovative, user-configurable, output-voltage setting from 0.9 V to 3.5 V, thus eliminating external resistors and any associated errors.

The TPS7A7300 has very fast load-transient response, is stable with ceramic output capacitors, and supports a better than 2% accuracy over line, load, and temperature. A soft-start pin allows for an application to reduce inrush into the load. Additionally, an open-drain, power-good signal allows for sequencing power rails.

The TPS7A7300 is available in a 5-mm × 5-mm, 20-pin VQFN package.

Package Information

PART NUMBER	PACKAGE ⁽¹⁾	PACKAGE SIZE ⁽²⁾
TPS7A7300	RGW (VQFN, 20)	5 mm × 5 mm

- (1) For all available packages, see the orderable addendum at the end of the data sheet.
- (2) The package size (length × width) is a nominal value and includes pins, where applicable.

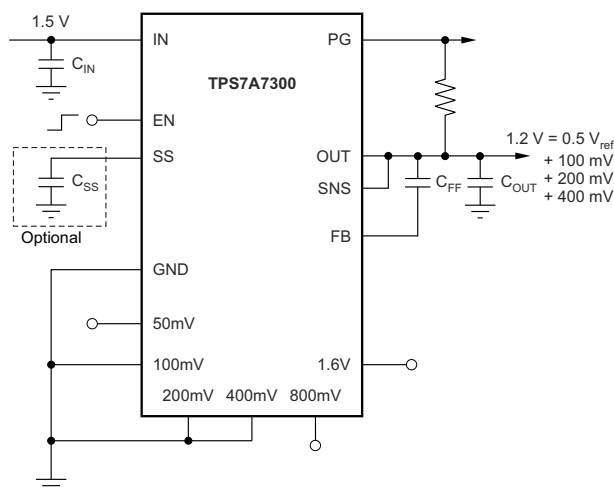

Typical Application

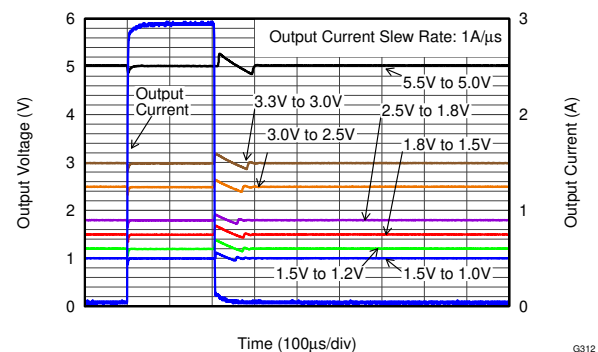

Load Transient Response With Seven Different Outputs



Table of Contents

1 Features	1	7 Application and Implementation	23
2 Applications	1	7.1 Application Information.....	23
3 Description	1	7.2 Typical Application.....	23
4 Pin Configurations	3	7.3 Power Supply Recommendations.....	26
5 Specifications	4	7.4 Layout.....	27
5.1 Absolute Maximum Ratings.....	4	8 Device And Documentation Support	31
5.2 ESD Ratings.....	4	8.1 Documentation Support.....	31
5.3 Recommended Operating Conditions.....	4	8.2 Receiving Notification of Documentation Updates...31	
5.4 Thermal Information.....	5	8.3 Support Resources.....	31
5.5 Electrical Characteristics.....	6	8.4 Trademarks.....	31
5.6 Typical Characteristics.....	7	8.5 Electrostatic Discharge Caution.....	31
6 Detailed Description	11	8.6 Glossary.....	31
6.1 Overview.....	11	9 Revision History	31
6.2 Functional Block Diagram.....	11	10 Mechanical, Packaging, And Orderable	
6.3 Feature Description.....	12	Information	32
6.4 Device Functional Modes.....	22		

4 Pin Configurations

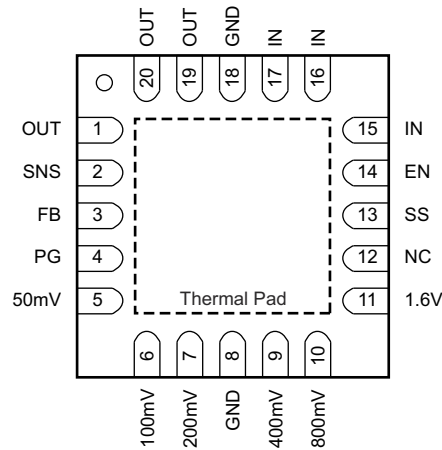

Figure 4-1. RGW Package, 20-Pin VQFN With Exposed Thermal Pad (Top View)

Table 4-1. Pin Functions

PIN		I/O	DESCRIPTION
NAME	RGW		
50mV, 100mV, 200mV, 400mV, 800mV, 1.6V	5, 6, 7, 9, 10, 11	I	Output voltage setting pins. These pins must be connected to ground or left floating. Connecting these pins to ground increases the output voltage by the value of the pin name; multiple pins can be simultaneously connected to GND to select the desired output voltage. Leave these pins floating (open) when not in use. See the User-Configurable Output Voltage section for more details.
EN	14	I	Enable pin. Driving this pin to logic high enables the device; driving the pin to logic low disables the device. See the Enable section for more details.
FB	3	I	Output voltage feedback pin. Connected to the error amplifier. See the User-Configurable Output Voltage and Traditional Adjustable Configuration sections for more details. Connect a 220-pF ceramic capacitor from the FB pin to OUT.
GND	8, 18	—	Ground pin.
IN	15, 16, 17	I	Unregulated supply voltage pin. Connect an input capacitor to this pin. See the Input Capacitor Requirements section for more details.
NC	12	—	Not internally connected. The NC pin is not connected to any electrical node. This pin and the thermal pad must be connected to a large-area ground plane. See the Power Dissipation section for more details.
OUT	1, 19, 20	O	Regulated output pin. A 4.7- μ F or larger capacitance is required for stability. See the Output Capacitor Requirements section for more details.
PG	4	O	Active-high power good pin. An open-drain output that indicates when the output voltage reaches 90% of the target. See the Power-Good section for more details.
SNS	2	I	Output voltage sense input pin. See the User-Configurable Output Voltage and Traditional Adjustable Configuration sections for more details.
SS	13	—	Soft-start pin. Leaving this pin open provides a soft start of the default setting. Connecting an external capacitor between this pin and ground enables the soft-start function by forming an RC-delay circuit in combination with the integrated resistance on the silicon. See the Soft-Start section for more details.
Thermal Pad		—	The thermal pad must be connected to a large-area ground plane. If available, connect an electrically-floating, dedicated thermal plane to the thermal pad as well.

5 Specifications

5.1 Absolute Maximum Ratings

over operating junction temperature range (unless otherwise noted)⁽¹⁾

		MIN	MAX	UNIT
Voltage	IN, PG, EN	-0.3	7	V
	SS, FB, SNS, OUT	-0.3	$V_{IN} + 0.3^{(2)}$	V
	50 mV, 100 mV, 200 mV, 400 mV, 800 mV, 1.6 V	-0.3	$V_{OUT} + 0.3^{(2)}$	V
Current	OUT	Internally limited		A
	PG (sink current into IC)	5		mA
Temperature	Operating virtual junction, T_J	-55	160	°C
	Storage, T_{stg}	-55	150	°C

- (1) Stresses beyond those listed under *Absolute Maximum Ratings* may cause permanent damage to the device. These are stress ratings only, and functional operation of the device at these or any other conditions beyond those indicated is not implied. Exposure to absolute-maximum-rated conditions for extended periods may affect device reliability.
- (2) The absolute maximum rating is $V_{IN} + 0.3$ V or +7 V, whichever is smaller.

5.2 ESD Ratings

			VALUE	UNIT
$V_{(ESD)}$	Electrostatic discharge	Human-body model (HBM), per ANSI/ESDA/JEDEC JS-001 ⁽¹⁾	±2000	V
		Charged-device model (CDM), per JEDEC specification JESD22-C101 ⁽²⁾	±500	

- (1) JEDEC document JEP155 states that 500-V HBM allows safe manufacturing with a standard ESD control process.
- (2) JEDEC document JEP157 states that 250-V CDM allows safe manufacturing with a standard ESD control process.

5.3 Recommended Operating Conditions

over operating junction temperature range (unless otherwise noted)

		MIN	NOM	MAX	UNIT
V_{IN}	Supply voltage	1.425		6.5	V
V_{OUT}	Output voltage	0.9		5	V
V_{EN}	Enable voltage	0		6.5	V
V_{PG}	Pullup voltage	0		6.5	V
	Any-out voltage: 50 mV, 100 mV, 200 mV, 400 mV, 800 mV, 1.6 V	0		V_{OUT}	V
I_{OUT}	Output current	0		3	A
C_{OUT}	Output capacitance	4.7		200 ⁽¹⁾	µF
C_{FB}	Feedforward capacitance	0		100	nF
T_J	Junction temperature	-40		125	°C

- (1) For output capacitors larger than 47 µF, a feedforward capacitor of at least 220 pF must be used.

5.4 Thermal Information

THERMAL METRIC ⁽¹⁾		TPS7A7300	UNIT
		RGW (VQFN)	
		20 PINS	
$R_{\theta JA}$	Junction-to-ambient thermal resistance	35.7	°C/W
$R_{\theta JC(top)}$	Junction-to-case (top) thermal resistance	33.6	°C/W
$R_{\theta JB}$	Junction-to-board thermal resistance	15.2	°C/W
ψ_{JT}	Junction-to-top characterization parameter	0.4	°C/W
ψ_{JB}	Junction-to-board characterization parameter	15.4	°C/W
$R_{\theta JC(bot)}$	Junction-to-case (bottom) thermal resistance	3.8	°C/W

- (1) For more information about traditional and new thermal metrics, see the [Semiconductor and IC Package Thermal Metrics application note](#).

5.5 Electrical Characteristics

over operating temperature range ($T_J = -40^\circ\text{C}$ to $+125^\circ\text{C}$), $1.425\text{ V} \leq V_{IN} \leq 6.5\text{ V}$, $V_{IN} \geq V_{OUT(\text{TARGET})} + 0.3\text{ V}$ or $V_{IN} \geq V_{OUT(\text{TARGET})} + 0.7\text{ V}$ ⁽¹⁾ ⁽²⁾, OUT connected to $50\ \Omega$ to GND⁽⁴⁾, $V_{EN} = 1.1\text{ V}$, $C_{OUT} = 10\ \mu\text{F}$, $C_{SS} = 10\ \text{nF}$, $C_{FF} = 0\ \text{pF}$ (RGW package), $C_{FF} = 220\ \text{pF}$ (RGT package)⁽⁸⁾, and PG pin pulled up to V_{IN} with $100\ \text{k}\Omega$, $27\ \text{k}\Omega \leq R_2 \leq 33\ \text{k}\Omega$ for adjustable configuration⁽³⁾ (unless otherwise noted); typical values are at $T_J = +25^\circ\text{C}$

PARAMETER		TEST CONDITIONS	MIN	TYP	MAX	UNIT
V_{IN}	Input voltage range		1.425		6.5	V
$V_{(SS)}$	SS pin voltage			0.5		V
V_{OUT}	Output voltage range	Adjustable with external feedback resistors	0.9		5	V
		Fixed with voltage setting pins	0.9		3.5	
	Output voltage accuracy ⁽⁵⁾ ⁽⁶⁾	Adjustable, $25\ \text{mA} \leq I_{OUT} \leq 3\ \text{A}$	-2.0%		2.0%	
		Fixed, $25\ \text{mA} \leq I_{OUT} \leq 3\ \text{A}$	-3.0%		3%	
$\Delta V_{O(\Delta V)}$	Line regulation	$I_{OUT} = 25\ \text{mA}$		0.01		%/V
$\Delta V_{O(\Delta I)}$	Load regulation	$25\ \text{mA} \leq I_{OUT} \leq 3\ \text{A}$		0.1		%/A
$V_{(DO)}$	Dropout voltage ⁽⁷⁾	$V_{OUT} \leq 3.3\ \text{V}$, $I_{OUT} = 3\ \text{A}$, $V_{(FB)} = \text{GND}$			240	mV
		$3.3\ \text{V} < V_{OUT}$, $I_{OUT} = 3\ \text{A}$, $V_{(FB)} = \text{GND}$			700	
$I_{(LIM)}$	Output current limit	V_{OUT} forced at $0.9 \times V_{OUT(\text{TARGET})}$, $V_{IN} = 3.3\ \text{V}$, $V_{OUT(\text{TARGET})} = 0.9\ \text{V}$		3.6		A
$I_{(GND)}$	GND pin current	Full load, $I_{OUT} = 3\ \text{A}$		3.7		mA
		Minimum load, $V_{IN} = 6.5\ \text{V}$, $V_{OUT(\text{TARGET})} = 0.9\ \text{V}$, $I_{OUT} = 25\ \text{mA}$			4	
		Shutdown, PG = (open), $V_{IN} = 6.5\ \text{V}$, $V_{OUT(\text{TARGET})} = 0.9\ \text{V}$, $V_{(EN)} < 0.5\ \text{V}$		0.1	5	μA
$I_{(EN)}$	EN pin current	$V_{IN} = 6.5\ \text{V}$, $V_{(EN)} = 0\ \text{V}$ and $6.5\ \text{V}$			± 0.1	μA
$V_{IL(EN)}$	EN pin low-level input voltage (disable device)		0		0.5	V
$V_{IH(EN)}$	EN pin high-level input voltage (enable device)		1.1		6.5	V
$V_{IT(PG)}$	PG pin threshold	For the direction PG \downarrow with decreasing V_{OUT}	$0.85V_{OUT}$	$0.9V_{OUT}$	$0.96V_{OUT}$	V
$V_{hys(PG)}$	PG pin hysteresis	For PG \uparrow		$0.02V_{OUT}$		V
$V_{OL(PG)}$	PG pin low-level output voltage	$V_{OUT} < V_{IT(PG)}$, $I_{PG} = -1\ \text{mA}$ (current into device)			0.4	V
$I_{kg(PG)}$	PG pin leakage current	$V_{OUT} > V_{IT(PG)}$, $V_{(PG)} = 6.5\ \text{V}$			1	μA
$I_{(SS)}$	SS pin charging current	$V_{(SS)} = \text{GND}$, $V_{IN} = 3.3\ \text{V}$	3.5	5.1	7.2	μA
V_n	Output noise voltage	BW = 100 Hz to 100 kHz, $V_{IN} = 1.5\ \text{V}$, $V_{OUT} = 1.2\ \text{V}$, $I_{OUT} = 3\ \text{A}$		39.46		μV_{RMS}
T_{sd}	Thermal shutdown temperature	Shutdown, temperature increasing		160		$^\circ\text{C}$
		Reset, temperature decreasing		140		
T_J	Operating junction temperature		-40		125	$^\circ\text{C}$

- (1) When $V_{OUT} \leq 3.5\ \text{V}$, $V_{IN} \geq (V_{OUT} + 0.3\ \text{V})$ or $1.425\ \text{V}$, whichever is greater; when $V_{OUT} > 3.5\ \text{V}$, $V_{IN} \geq (V_{OUT} + 0.7\ \text{V})$.
- (2) $V_{OUT(\text{TARGET})}$ is the calculated target V_{OUT} value from the output voltage setting pins: 50mV, 100mV, 200mV, 400mV, 800mV, and 1.6V in fixed configuration, or the expected V_{OUT} value set by external feedback resistors in adjustable configuration.
- (3) R_2 is the bottom-side of the feedback resistor between the FB pin and GND. See the [Traditional Adjustable Configuration](#) section for details.
- (4) This 50- Ω load is disconnected when the test conditions specify an I_{OUT} value.
- (5) When the TPS7A7300 is connected to external feedback resistors at the FB pin, external resistor tolerances are not included.
- (6) The TPS7A7300 is not tested at $V_{OUT} = 0.9\ \text{V}$, $2.7\ \text{V} \leq V_{IN} \leq 6.5\ \text{V}$, and $500\ \text{mA} \leq I_{OUT} \leq 3\ \text{A}$ because the power dissipation is higher than the maximum rating of the package. Also, this accuracy specification does not apply on any application condition that exceeds the power dissipation limit of the package.
- (7) $V_{(DO)}$ is not defined for output voltage settings less than 1.2 V.
- (8) C_{FF} is the capacitor between FB pin and OUT.

5.6 Typical Characteristics

at $T_J = 25^\circ\text{C}$, $V_{IN} = V_{OUT(TARGET)} + 0.3\text{ V}$, $I_{OUT} = 25\text{ mA}$, $V_{(EN)} = V_{IN}$, $C_{IN} = 10\ \mu\text{F}$, $C_{OUT} = 10\ \mu\text{F}$, $C_{(SS)} = 10\ \text{nF}$, and the PG pin pulled up to V_{IN} with a 100-k Ω pullup resistor (unless otherwise noted)

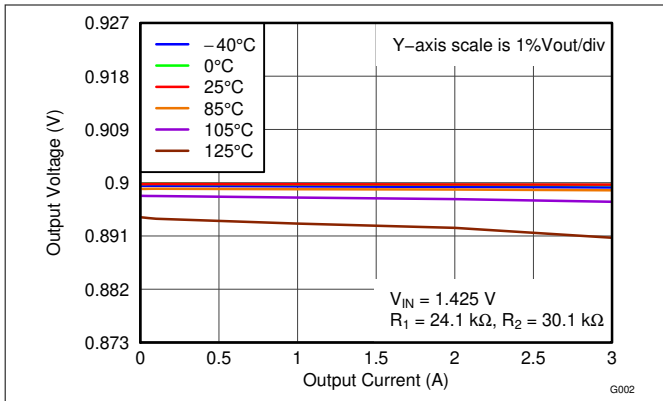

Figure 5-1. Load Regulation (0.9 V, Adjustable)

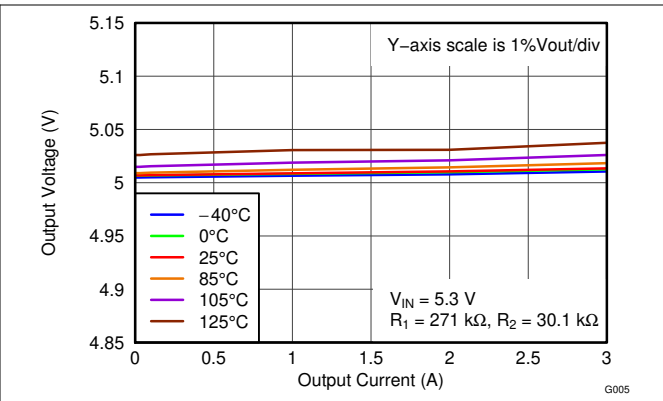

Figure 5-2. Load Regulation (5.0 V, Adjustable)

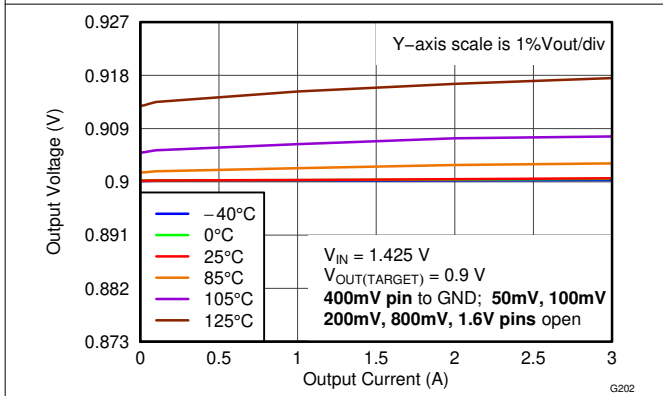

Figure 5-3. Load Regulation (0.9 V, Fixed By Setting Pins)

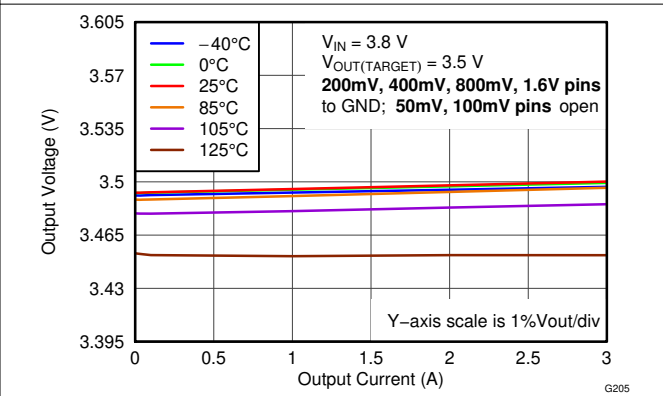

Figure 5-4. Load Regulation (3.5 V, Fixed By Setting Pins)

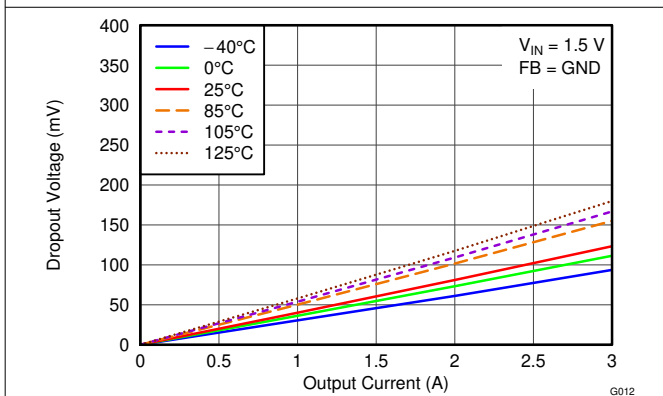

Figure 5-5. Dropout Voltage vs Output Current

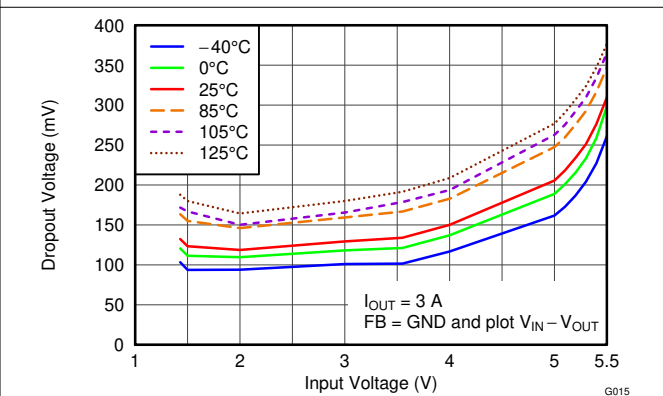

Figure 5-6. Dropout Voltage vs Temperature

5.6 Typical Characteristics (continued)

at $T_J = 25^\circ\text{C}$, $V_{IN} = V_{OUT(TARGET)} + 0.3\text{ V}$, $I_{OUT} = 25\text{ mA}$, $V_{(EN)} = V_{IN}$, $C_{IN} = 10\text{ }\mu\text{F}$, $C_{OUT} = 10\text{ }\mu\text{F}$, $C_{(SS)} = 10\text{ nF}$, and the PG pin pulled up to V_{IN} with a 100-k Ω pullup resistor (unless otherwise noted)

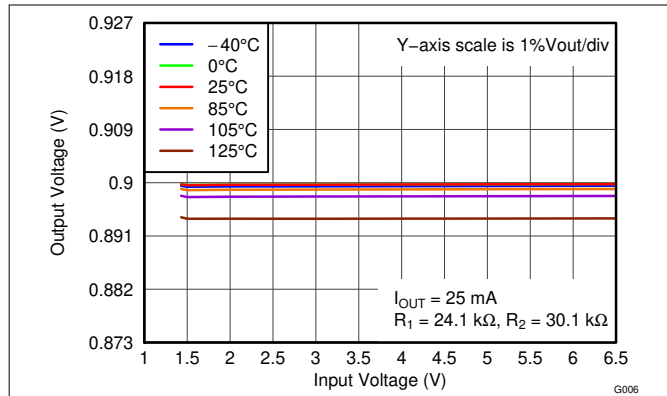

Figure 5-7. Line Regulation (0.9 V, Adjustable)

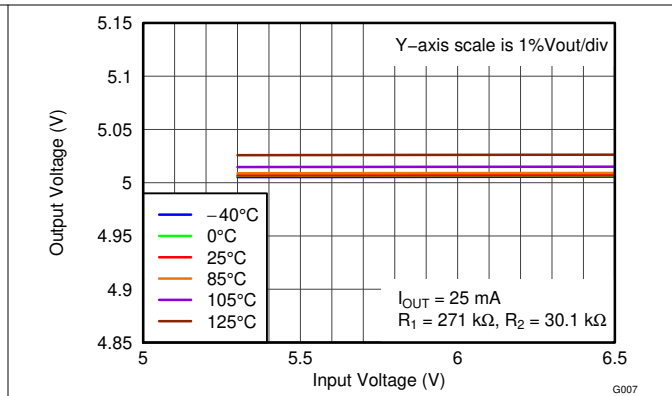

Figure 5-8. Line Regulation (5 V, Adjustable)

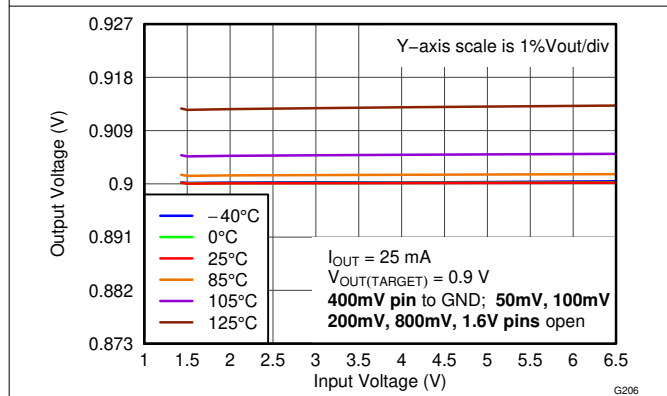

Figure 5-9. Line Regulation (0.9 V, Fixed By Setting Pins)

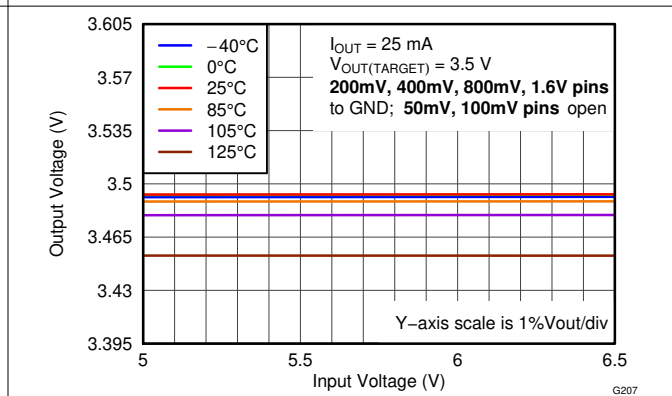

Figure 5-10. Line Regulation (3.5 V, Fixed By Setting Pins)

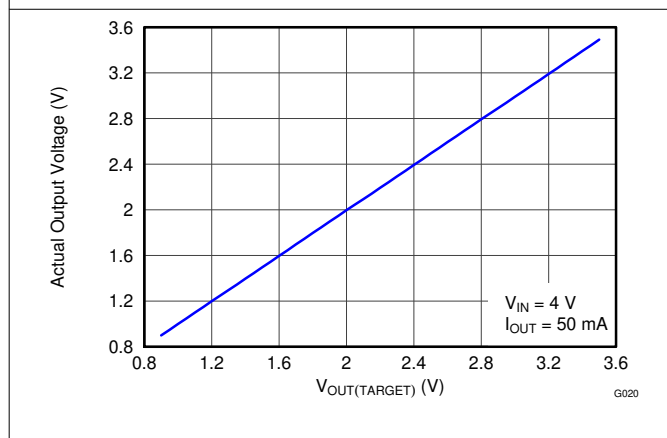

Figure 5-11. Measured Output Voltage vs Pin Setting

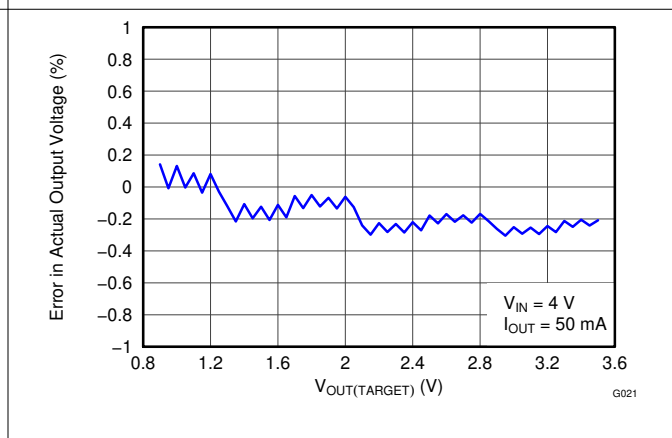

Figure 5-12. Accuracy vs Pin Setting

5.6 Typical Characteristics (continued)

at $T_J = 25^\circ\text{C}$, $V_{IN} = V_{OUT(TARGET)} + 0.3\text{ V}$, $I_{OUT} = 25\text{ mA}$, $V_{(EN)} = V_{IN}$, $C_{IN} = 10\ \mu\text{F}$, $C_{OUT} = 10\ \mu\text{F}$, $C_{(SS)} = 10\ \text{nF}$, and the PG pin pulled up to V_{IN} with a 100-k Ω pullup resistor (unless otherwise noted)

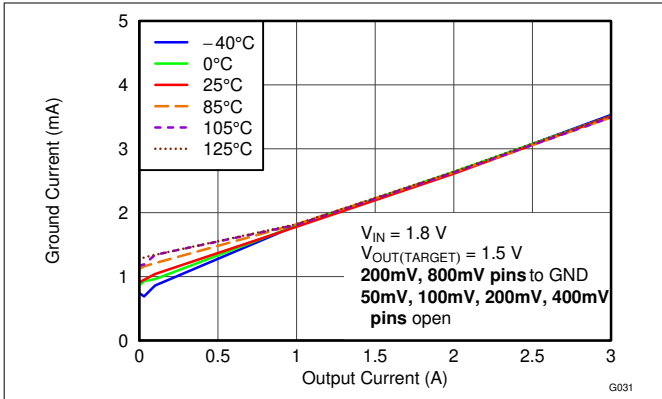

Figure 5-13. GND Pin Current vs Output Current

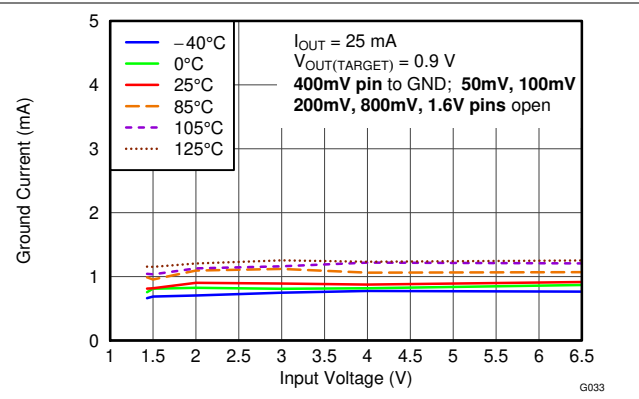

Figure 5-14. GND Pin Current vs Input Voltage

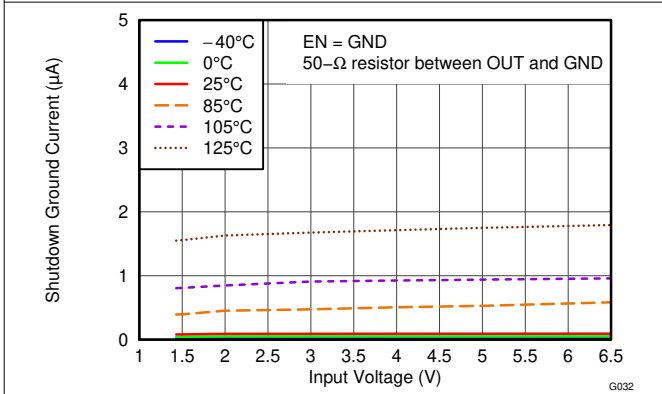

Figure 5-15. GND Pin Current In Shutdown vs Temperature

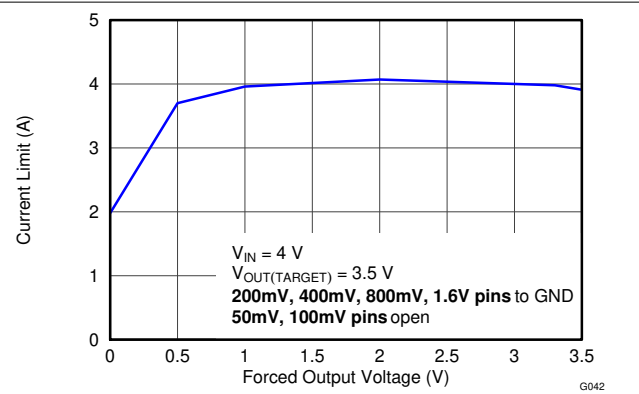

Figure 5-16. Current Limit vs Output Voltage (Foldback)

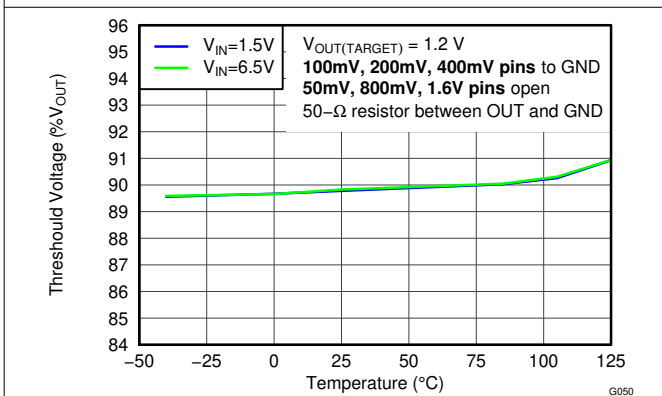

Figure 5-17. Power-Good Threshold Voltage vs Temperature

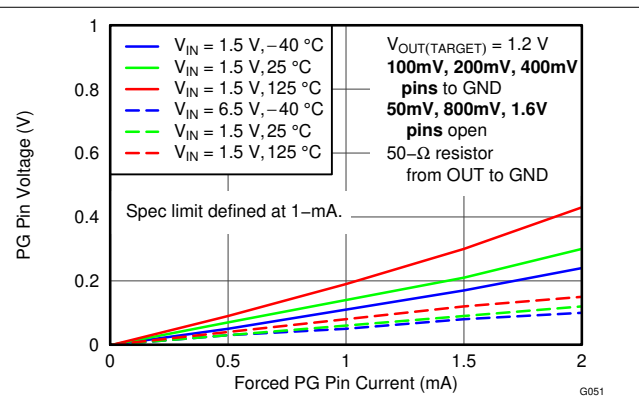

Figure 5-18. Power-Good Pin Drive Capability

5.6 Typical Characteristics (continued)

at $T_J = 25^\circ\text{C}$, $V_{IN} = V_{OUT(TARGET)} + 0.3\text{ V}$, $I_{OUT} = 25\text{ mA}$, $V_{(EN)} = V_{IN}$, $C_{IN} = 10\text{ }\mu\text{F}$, $C_{OUT} = 10\text{ }\mu\text{F}$, $C_{(SS)} = 10\text{ nF}$, and the PG pin pulled up to V_{IN} with a 100-k Ω pullup resistor (unless otherwise noted)

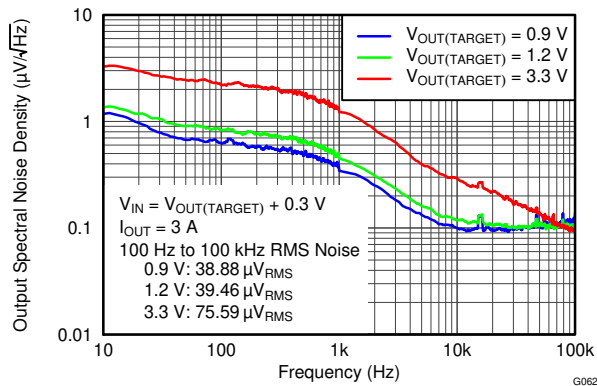

Figure 5-19. Noise Spectral Density By Output Voltage

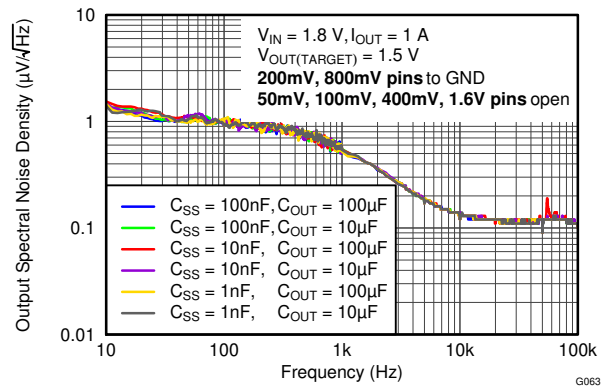

Figure 5-20. Noise Spectral Density By External Capacitors

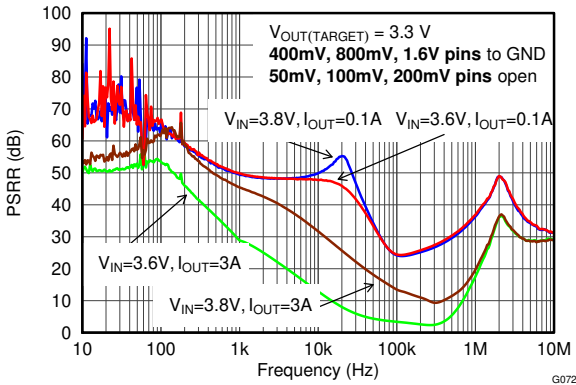

Figure 5-21. Power-Supply Ripple Rejection vs Frequency

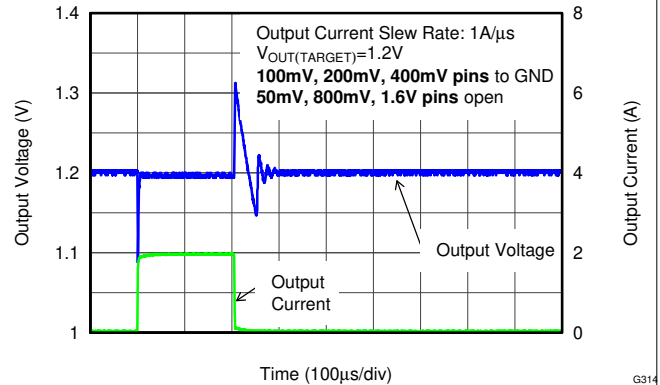

Figure 5-22. Load Transient Response ($V_{OUT} = 1.2\text{ V}$)

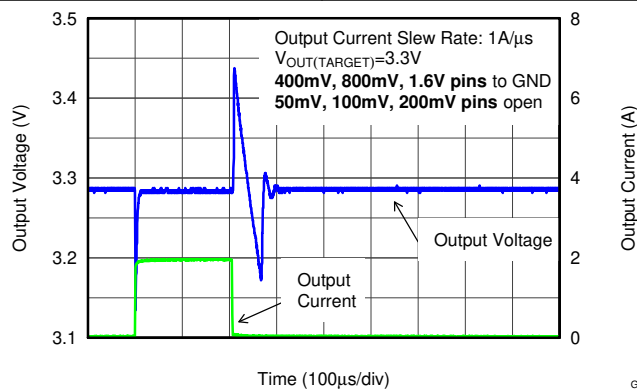

Figure 5-23. Load Transient Response ($V_{OUT} = 3.3\text{ V}$)

6 Detailed Description

6.1 Overview

The TPS7A7300 is a low-dropout (LDO) regulator that uses innovative circuitry to offer very low dropout voltage along with the flexibility of a programmable output voltage.

The dropout voltage for this LDO regulator is 0.24 V at 3 A. This voltage makes the TPS7A7300 into a point-of-load (POL) regulator because 0.24 V at 3 A is lower than any voltage gap among the most common voltage rails: 1.2 V, 1.5 V, 1.8 V, 2.5 V, 3 V, and 3.3 V. This device offers a fully user-configurable output voltage setting method. The TPS7A7300 output voltage can be programmed to any target value from 0.9 V to 3.5 V in 50-mV steps.

Another big advantage of using the TPS7A7300 is the wide range of available operating input voltages: from 1.5 V to 6.5 V. The TPS7A7300 also has very good line and load transient response. All these features allow the TPS7A7300 to meet most voltage-regulator needs for under 6-V applications, using only one device so less time is spent on inventory control.

Texas Instruments also offers different output current ratings with other family devices: the [TPS7A7100](#) (1 A) and [TPS7A7200](#) (2 A).

6.2 Functional Block Diagram

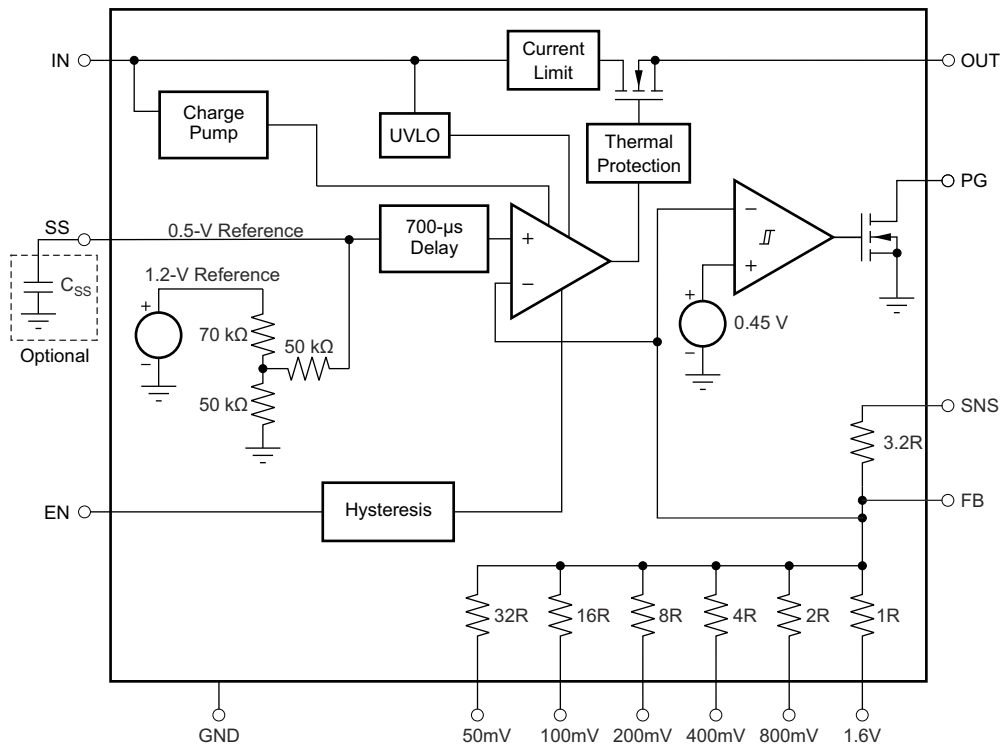

NOTE: 32R = 1.024 MΩ (that is, 1R = 32 kΩ).

6.3 Feature Description

6.3.1 User-Configurable Output Voltage

Unlike traditional LDO devices, the TPS7A7300 comes with only one orderable part number. There is no adjustable or fixed output voltage option. The output voltage of the TPS7A7300 is selectable in accordance with the names given to the output voltage setting pins: 50 mV, 100 mV, 200 mV, 400 mV, 800 mV, and 1.6 V. For each pin connected to the ground, the output voltage setting increases by the value associated with that pin name, starting from the value of the reference voltage of 0.5 V. Floating the pins has no effect on the output voltage. [Figure 6-1](#) through [Figure 6-6](#) show examples of how to program the output voltages.

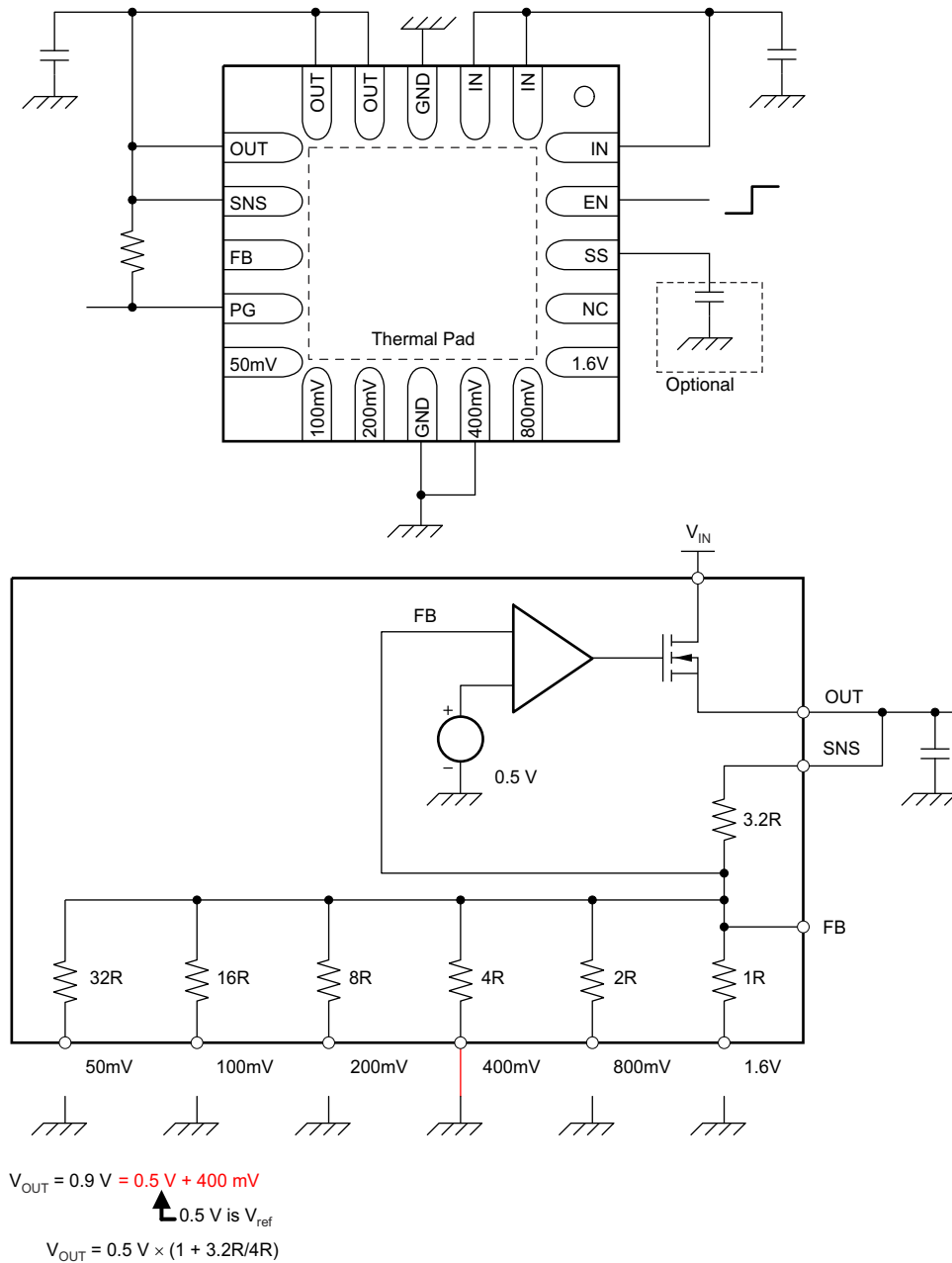
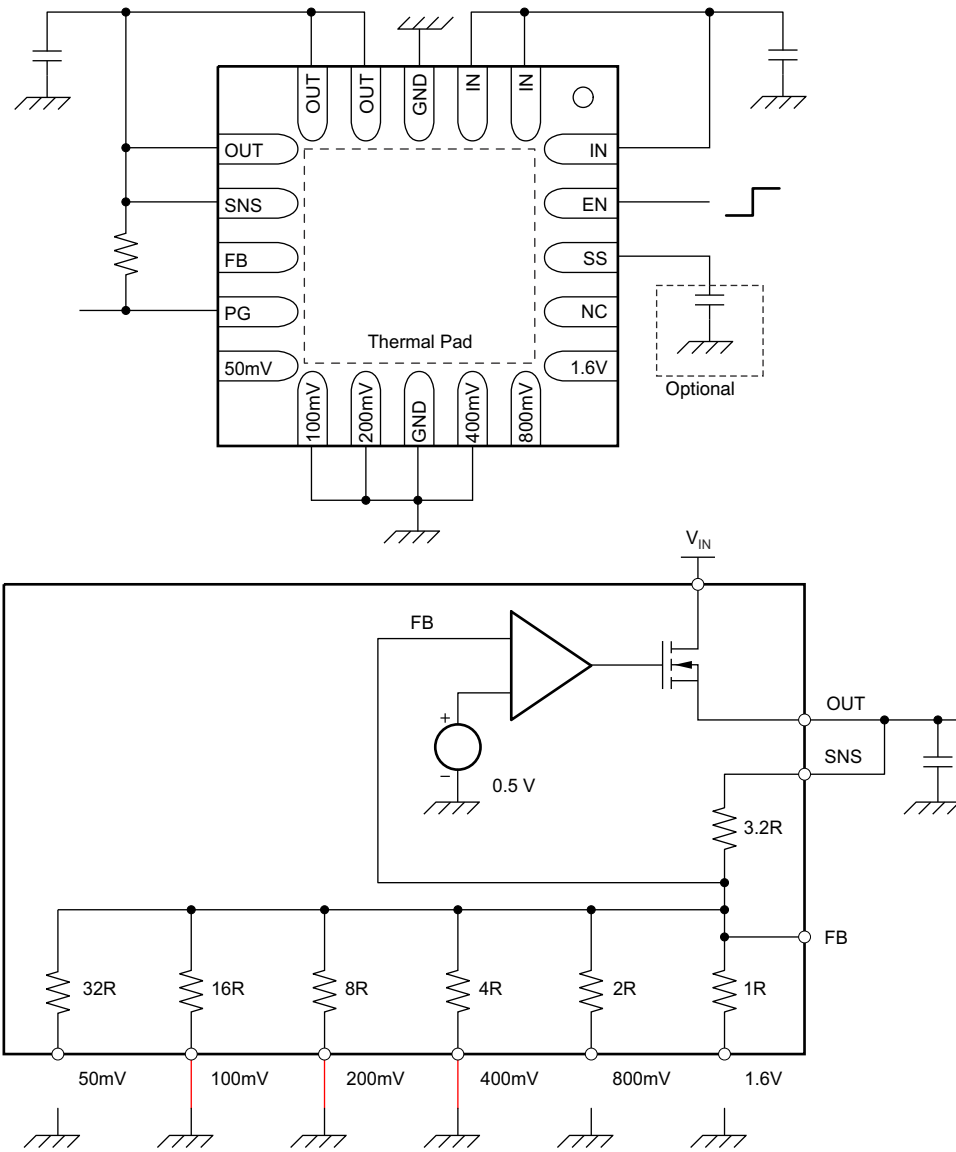

Figure 6-1. 0.9-V Configuration



$$V_{OUT} = 1.2\text{ V} = 0.5\text{ V} + 100\text{ mV} + 200\text{ mV} + 400\text{ mV}$$

↑ 0.5 V is V_{ref}

$$V_{OUT} = 0.5\text{ V} \times (1 + 3.2R/2.29R) \quad 2.29R \text{ is parallel resistance of } 16R, 8R, \text{ and } 4R.$$

Figure 6-2. 1.2-V Configuration

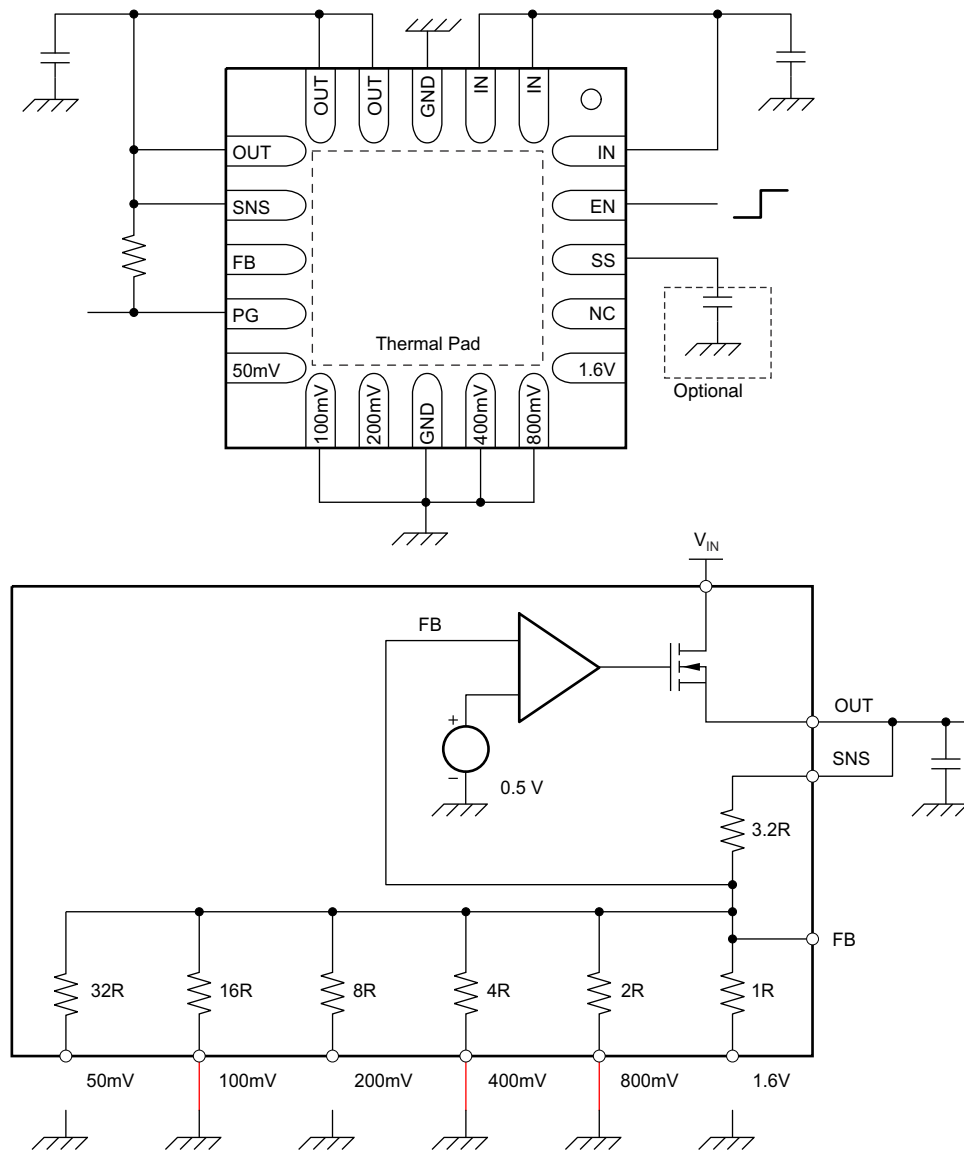

$$V_{OUT} = 1.8\text{ V} = 0.5\text{ V} + 100\text{ mV} + 400\text{ mV} + 800\text{ mV}$$

↑ 0.5 V is V_{ref}

$$V_{OUT} = 0.5\text{ V} \times (1 + 3.2R/1.23R) \quad \text{1.23R is parallel resistance of 16R, 4R, and 2R.}$$

Figure 6-3. 1.8-V Configuration

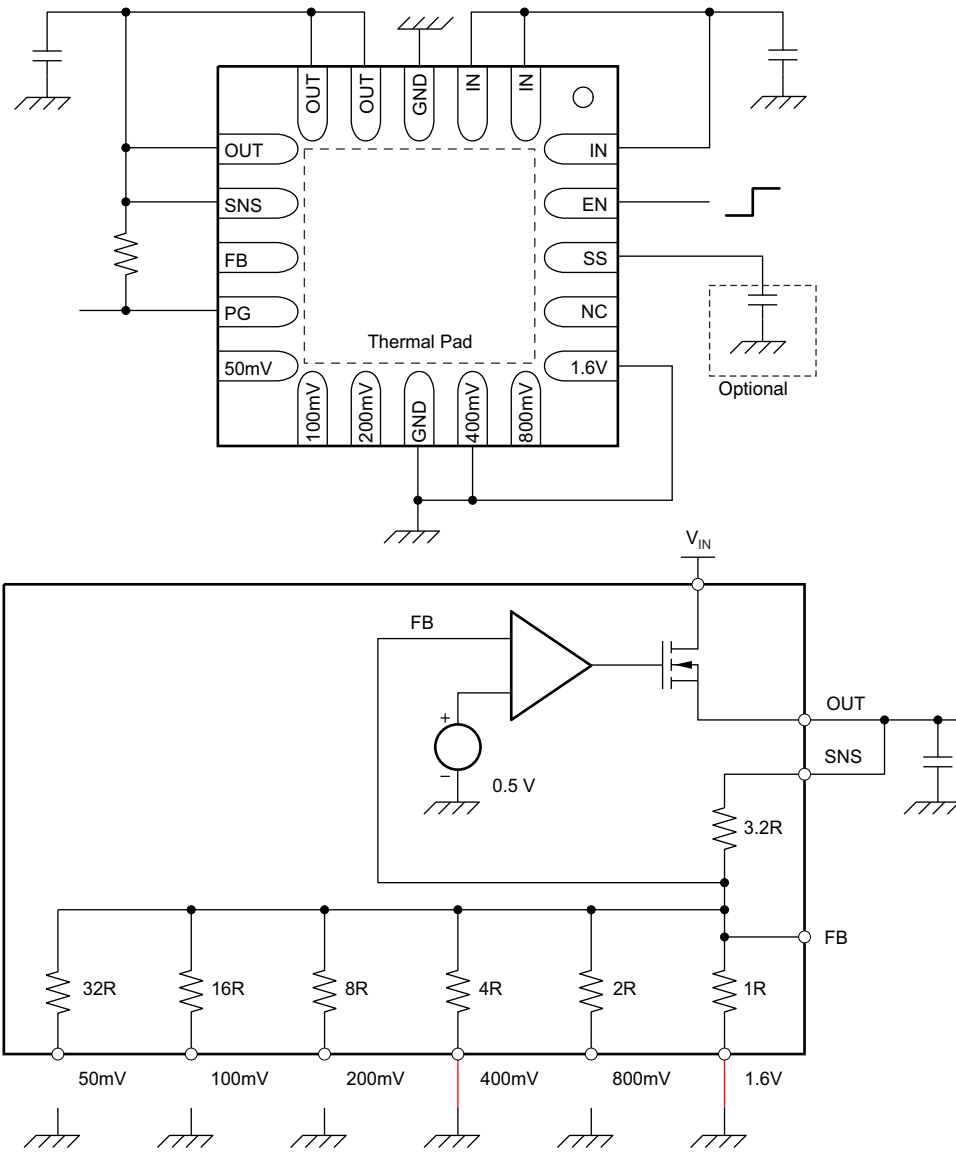

$$V_{OUT} = 2.5 \text{ V} = 0.5 \text{ V} + 400 \text{ mV} + 1.6 \text{ V}$$

↑ 0.5 V is V_{ref}

$$V_{OUT} = 0.5 \text{ V} \times (1 + 3.2R/0.8R) \quad 0.8R \text{ is parallel resistance of } 4R \text{ and } 1R.$$

Figure 6-4. 2.5-V Configuration

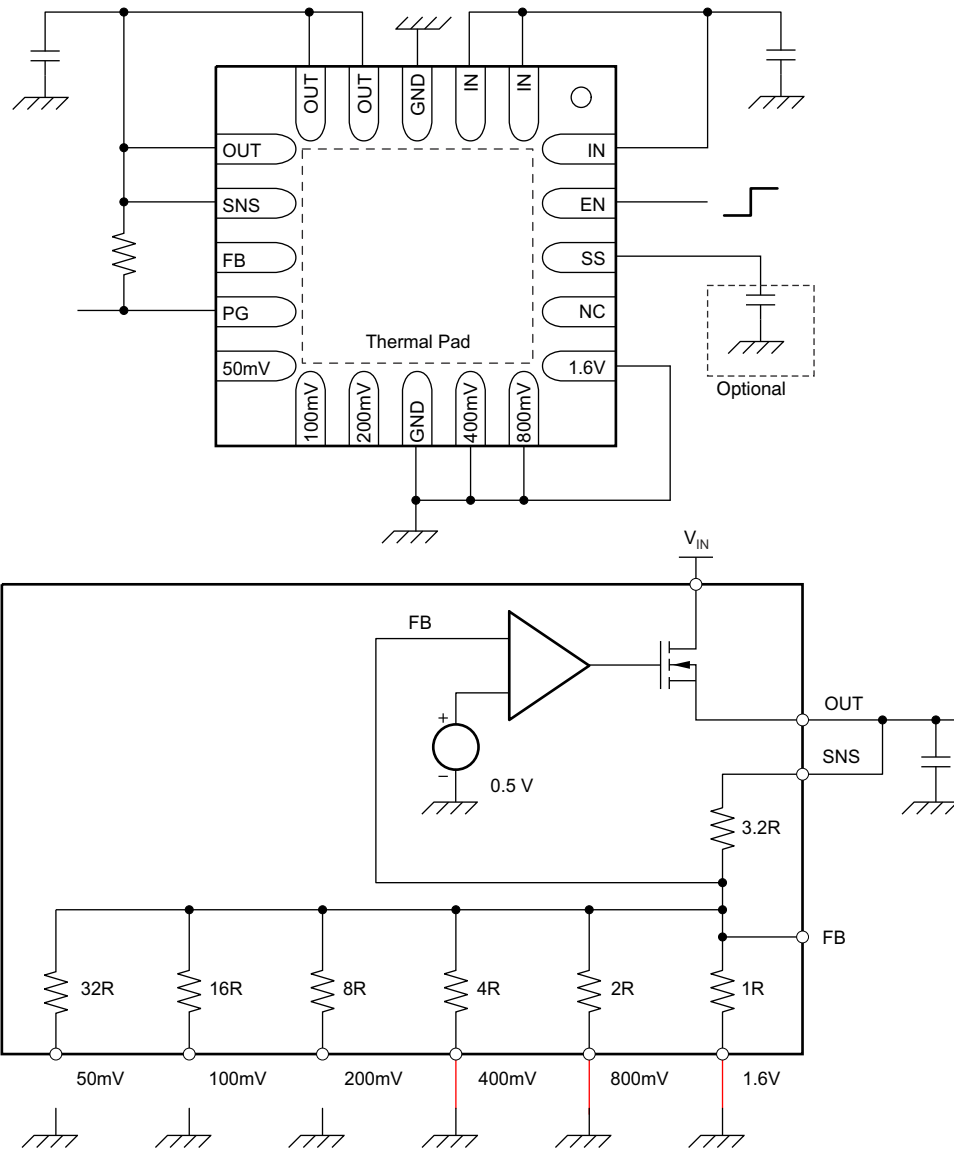

$$V_{OUT} = 3.3\text{ V} = 0.5\text{ V} + 400\text{ mV} + 800\text{ mV} + 1.6\text{ V}$$

↑ 0.5 V is V_{ref}

$$V_{OUT} = 0.5\text{ V} \times (1 + 3.2R/0.571R) \quad 0.571R \text{ is parallel resistance of } 4R, 2R, \text{ and } 1R.$$

Figure 6-5. 3.3-V Configuration

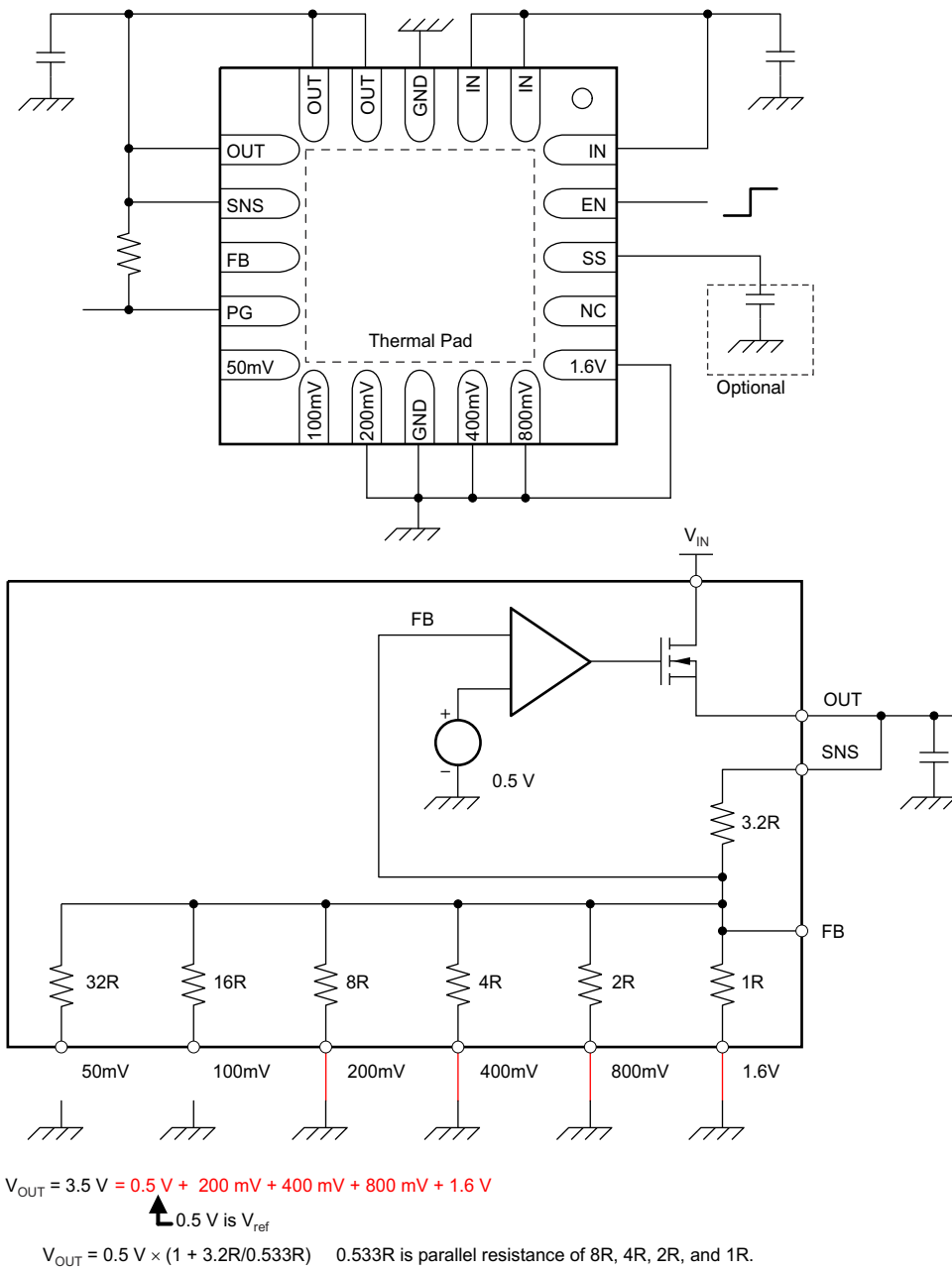

Figure 6-6. 3.5-V Configuration

See [Table 6-1](#) for a full list of target output voltages and corresponding pin settings. The voltage setting pins have a binary weight; therefore, the output voltage can be programmed to any value from 0.9 V to 3.5 V in 50-mV steps.

[Figure 5-11](#) and [Figure 5-12](#) illustrate this output voltage programming performance.

Note

Any output voltage setting that is not listed in [Table 6-1](#) is not covered in the *Electrical Characteristics*. For output voltages greater than 3.5 V, use a traditional adjustable configuration (see the [Traditional Adjustable Configuration](#) section).

Table 6-1. User Configurable Output Voltage Setting

$V_{OUT(TARGET)}$ (V)	50 mV	100 mV	200 mV	400 mV	800 mV	1.6 V
0.9	open	open	open	GND	open	open
0.95	GND	open	open	GND	open	open
1	open	GND	open	GND	open	open
1.05	GND	GND	open	GND	open	open
1.1	open	open	GND	GND	open	open
1.15	GND	open	GND	GND	open	open
1.2	open	GND	GND	GND	open	open
1.25	GND	GND	GND	GND	open	open
1.3	open	open	open	open	GND	open
1.35	GND	open	open	open	GND	open
1.4	open	GND	open	open	GND	open
1.45	GND	GND	open	open	GND	open
1.5	open	open	GND	open	GND	open
1.55	GND	open	GND	open	GND	open
1.6	open	GND	GND	open	GND	open
1.65	GND	GND	GND	open	GND	open
1.7	open	open	open	GND	GND	open
1.75	GND	open	open	GND	GND	open
1.8	open	GND	open	GND	GND	open
1.85	GND	GND	open	GND	GND	open
1.9	open	open	GND	GND	GND	open
1.95	GND	open	GND	GND	GND	open
2	open	GND	GND	GND	GND	open
2.05	GND	GND	GND	GND	GND	open
2.1	open	open	open	open	open	GND
2.15	GND	open	open	open	open	GND
2.2	open	GND	open	open	open	GND
2.25	GND	GND	open	open	open	GND
2.3	open	open	GND	open	open	GND
2.35	GND	open	GND	open	open	GND
2.4	open	GND	GND	open	open	GND
2.45	GND	GND	GND	open	open	GND
2.5	open	open	open	GND	open	GND
2.55	GND	open	open	GND	open	GND
2.6	open	GND	open	GND	open	GND
2.65	GND	GND	open	GND	open	GND
2.7	open	open	GND	GND	open	GND
2.75	GND	open	GND	GND	open	GND
2.8	open	GND	GND	GND	open	GND
2.85	GND	GND	GND	GND	open	GND
2.9	open	open	open	open	GND	GND

Table 6-1. User Configurable Output Voltage Setting (continued)

$V_{OUT(TARGET)}$ (V)	50 mV	100 mV	200 mV	400 mV	800 mV	1.6 V
2.95	GND	open	open	open	GND	GND
3	open	GND	open	open	GND	GND
3.05	GND	GND	open	open	GND	GND
3.1	open	open	GND	open	GND	GND
3.15	GND	open	GND	open	GND	GND
3.2	open	GND	GND	open	GND	GND
3.25	GND	GND	GND	open	GND	GND
3.3	open	open	open	GND	GND	GND
3.35	GND	open	open	GND	GND	GND
3.4	open	GND	open	GND	GND	GND
3.45	GND	GND	open	GND	GND	GND
3.5	open	open	GND	GND	GND	GND

6.3.2 Traditional Adjustable Configuration

For any output voltage target that is not supported in the *User-Configurable Output Voltage* section, a traditional adjustable configuration with external-feedback resistors can be used with the TPS7A7300. Figure 6-7 shows how to configure the TPS7A7300 as an adjustable regulator with an equation and Table 6-2 lists recommended pairs of feedback resistor values.

Note

The bottom side of feedback resistor R2 in Figure 6-7 must be in the range of 27 kΩ to 33 kΩ to maintain the specified regulation accuracy.

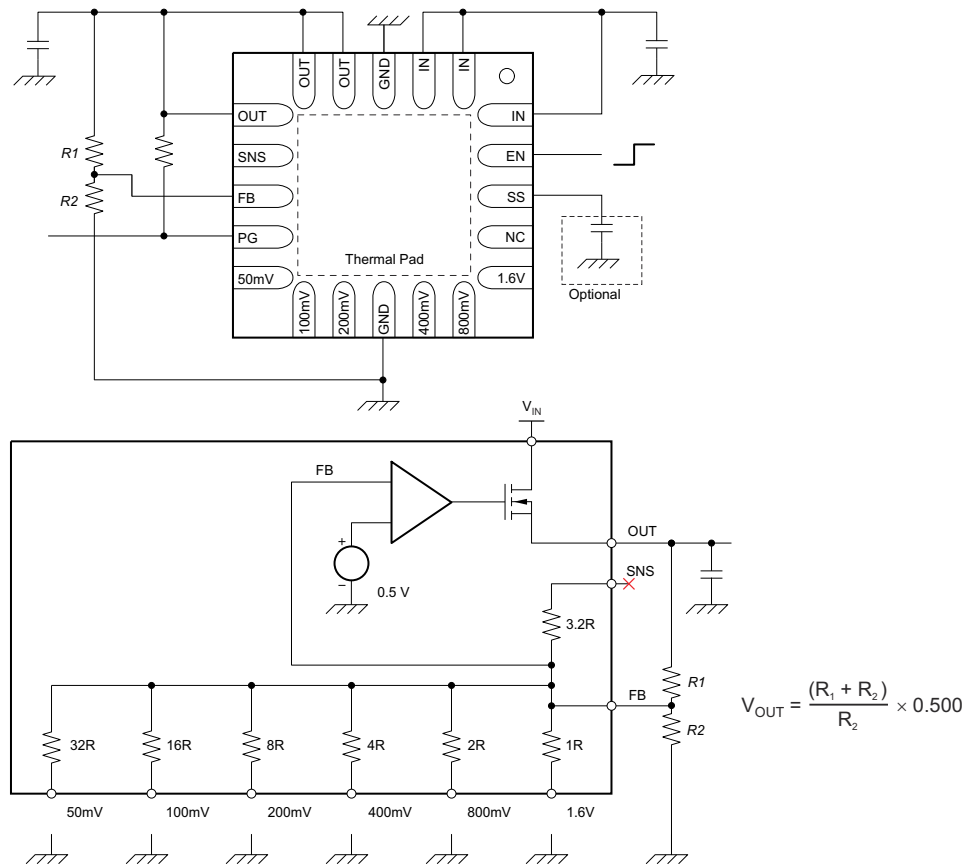

Figure 6-7. Traditional Adjustable Configuration With External Resistors

Table 6-2. Recommended Feedback-Resistor Values

V _{OUT(TARGET)} (V)	E96 SERIES		R40 SERIES	
	R1 (kΩ)	R2 (kΩ)	R1 (kΩ)	R2 (kΩ)
1	30.1	30.1	30	30
1.2	39.2	28	43.7	31.5
1.5	61.9	30.9	60	30
1.8	80.6	30.9	80	30.7
1.9	86.6	30.9	87.5	31.5
2.5	115	28.7	112	28
3	147	29.4	150	30
3.3	165	29.4	175	31.5
5	280	30.9	243	27.2

6.3.3 Undervoltage Lockout (UVLO)

The TPS7A7300 uses an undervoltage lockout circuit to keep the output shut off until the internal circuitry is operating properly. The UVLO circuit has a deglitch feature that typically ignores undershoot of the input voltage upon the event of device start-up. Still, a poor input line impedance can cause a severe input voltage drop when the device powers on. As explained in the [Input Capacitor Requirements](#) section, the input line impedance must be well-designed.

6.3.4 Soft-Start

The TPS7A7300 has an SS pin that provides a soft-start (slow start) function.

By leaving the SS pin open, the TPS7A7300 performs a soft-start by default.

As shown in the [Functional Block Diagram](#), by connecting a capacitor between the SS pin and ground, the C_{SS} capacitor forms an RC pair together with the integrated 50-k Ω resistor. The RC pair operates as an RC-delay circuit for the soft-start with the internal 700- μ s delay circuit.

The relationship between C_{SS} and the soft-start time is illustrated in the [Application Curves](#).

6.3.5 Current Limit

The TPS7A7300 internal current limit circuitry protects the regulator during fault conditions. During a current limit event, the output sources a fixed amount of current that is mostly independent of the output voltage. The current limit function is provided as a fail-safe mechanism and is not intended to be used regularly. Do **not** design any applications to use this current-limit function as a part of expected normal operation. Extended periods of current-limit operation degrade device reliability.

Powering on the device with the enable pin, or increasing the input voltage above the minimum operating voltage while a low-impedance short exists on the output of the device, can result in a sequence of high-current pulses from the input to the output of the device. The energy consumed by the device is minimal during these events; therefore, there is no failure risk. Additional input capacitance helps mitigate the load transient requirement of the upstream supply during these events.

6.3.6 Enable

The EN pin switches the enable and disable (shutdown) states of the TPS7A7300. A logic high input at the EN pin enables the device; a logic low input disables the device. When disabled, the device current consumption is reduced.

6.3.7 Power-Good

The TPS7A7300 has a power-good function that works with the PG output pin. When the output voltage undershoots the threshold voltage $V_{IT(PG)}$ during normal operation, the PG open-drain output turns from a high-impedance state to a low-impedance state. When the output voltage exceeds the $V_{IT(PG)}$ threshold by an amount greater than the PG hysteresis, $V_{hys(PG)}$, the PG open-drain output turns from a low-impedance state to high-impedance state. By connecting a pullup resistor (usually between the OUT and PG pins), any downstream device can receive an active-high enable logic signal.

When setting the output voltage to less than 1.8 V and using a pullup resistor between OUT and PG pins, depending on the downstream device specifications, the downstream device can possibly be unable to accept the PG output as a valid high-level logic voltage. In such cases, place a pullup resistor between the IN and PG pins, not between the OUT and PG pins.

[Figure 5-18](#) illustrates the open-drain output drive capability. The on-resistance of the open-drain transistor is calculated using [Figure 5-18](#), and is approximately 200 Ω . Any pullup resistor greater than 10 k Ω works fine for this purpose.

6.4 Device Functional Modes

6.4.1 Normal Operation

The device regulates to the nominal output voltage under the following conditions:

- The input voltage is at least as high as $V_{IN(MIN)}$
- The input voltage is greater than the nominal output voltage added to the dropout voltage
- The enable voltage has previously exceeded the enable rising threshold voltage and has not decreased below the enable falling threshold
- The output current is less than the current limit
- The device junction temperature is less than the maximum specified junction temperature

6.4.2 Dropout Operation

If the input voltage is lower than the nominal output voltage plus the specified dropout voltage, but all other conditions are met for normal operation, the device operates in dropout mode. In this mode of operation, the output voltage is the same as the input voltage minus the dropout voltage. The transient performance of the device is significantly degraded because the pass device (such as a bipolar junction transistor, or BJT) is in saturation and no longer controls the current through the LDO. Line or load transients in dropout can result in large output voltage deviations.

6.4.3 Disabled

The device is disabled under the following conditions:

- The enable voltage is less than the enable falling threshold voltage or has not yet exceeded the enable rising threshold
- The device junction temperature is greater than the thermal shutdown temperature

Table 6-3 lists the conditions that lead to the different modes of operation.

Table 6-3. Device Functional Mode Comparison

OPERATING MODE	PARAMETER			
	V_{IN}	V_{EN}	I_{OUT}	T_J
Normal mode	$V_{IN} > V_{OUT(NOM)} + V_{DO}$ and $V_{IN} > V_{IN(MIN)}$	$V_{EN} > V_{IH(EN)}$	$I_{OUT} < I_{(LIM)}$	$T_J < 125^{\circ}\text{C}$
Dropout mode	$V_{IN} < V_{OUT(NOM)} + V_{DO}$	$V_{EN} > V_{IH(EN)}$	—	$T_J < 125^{\circ}\text{C}$
Disabled mode (any true condition disables the device)	—	$V_{EN} < V_{IL(EN)}$	—	$T_J > 160^{\circ}\text{C}$

7 Application and Implementation

Note

Information in the following applications sections is not part of the TI component specification, and TI does not warrant its accuracy or completeness. TI's customers are responsible for determining suitability of components for their purposes, as well as validating and testing their design implementation to confirm system functionality.

7.1 Application Information

The TPS7A7300 is a very-low dropout LDO with very fast load transient response. The TPS7A7300 provides a number of features (such as a power-good signal for output monitoring and a soft-start pin to reduce inrush currents during start-up), and the device is designed for applications that require up to 3 A of output current.

7.2 Typical Application

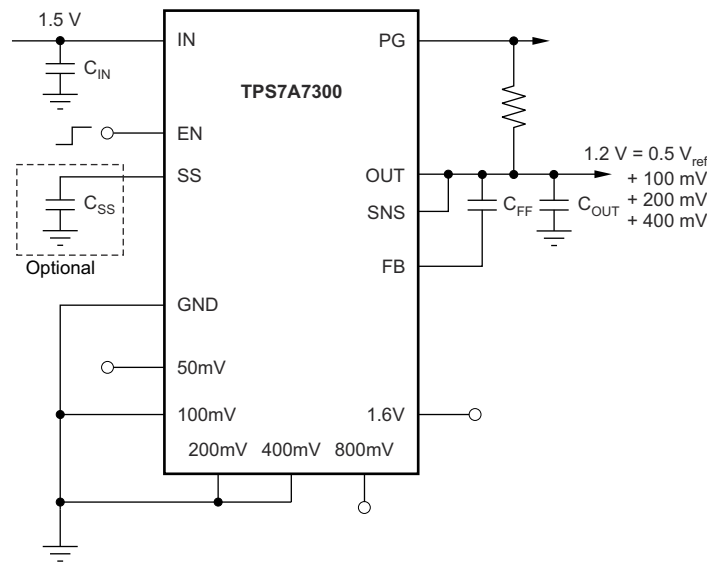

Figure 7-1. 1.2-V Output Using ANY-OUT Pins

7.2.1 Design Requirements

Table 7-1 lists the design parameters for this example.

Table 7-1. Design Parameters

DESIGN PARAMETER	EXAMPLE VALUE
Input voltage range	1.425 V to 6.5 V
Output voltage	1.2 V
Output current rating	3 A
Output capacitor range	4.7 μ F to 200 μ F
feedforward capacitor range	220 pF to 100 nF
Soft-start capacitor range	0 μ F to 1 μ F

7.2.2 Detailed Design Procedure

7.2.2.1 ANY-OUT Programmable Output Voltage

For ANY-OUT operation, the TPS7A7300 does not use any external resistors to set the output voltage, but uses device pins labeled 50 mV, 100 mV, 200 mV, 400 mV, 800 mV, and 1.6 V to set the regulated output voltage. Each pin is either connected to ground (active) or is left open (floating). The ANY-OUT programming is set as

the sum of the internal reference voltage ($V_{(SS)} = 0.5\text{ V}$) plus the sum of the respective voltages assigned to each active pin. By leaving all ANY-OUT pins open, or floating, the output is set to the minimum possible output voltage equal to $V_{(SS)}$. By grounding all of the ANY-OUT pins, the output is set to 3.65 V.

When using the ANY-OUT pins, the SNS pin must always be connected between the OUT and FB pins. However, the feedforward capacitor must be connected to the FB pin, not the SNS pin.

7.2.2.2 Traditional Adjustable Output Voltage

For applications that need the regulated output voltage to be greater than 3.65 V (or those that require more resolution than the 50 mV that the ANY-OUT pins provide), the TPS7A7300 can also be use the traditional adjustable method of setting the regulated output.

When using the traditional method of setting the output, the FB pin must be connected to the node connecting the top and bottom resistors of the resistor divider. The SNS pin must be left floating.

7.2.2.3 Input Capacitor Requirements

As a result of the very fast transient response and low-dropout operation support, the line impedance must be reduced at the input pin of the TPS7A7300. The line impedance depends heavily on various factors, such as wire (PCB trace) resistance, wire inductance, and output impedance of the upstream voltage supply (power supply to the TPS7A7300). Therefore, a specific value for the input capacitance cannot be recommended until the previously listed factors are finalized.

In addition, simple usage of large input capacitance can form an unwanted LC resonance in combination with input wire inductance. For example, a 5-nH inductor and a 10- μF input capacitor form an LC filter that has a resonance at 712 kHz. This value of 712 kHz is well inside the bandwidth of the TPS7A7300 control loop.

The best guideline is to use a capacitor of up to 1 μF with well-designed wire connections (PCB layout) to the upstream supply. If optimizing the input line is difficult, use a large tantalum capacitor in combination with a good-quality, low-ESR, 1- μF ceramic capacitor.

7.2.2.4 Output Capacitor Requirements

The TPS7A7300 is designed to be stable with standard ceramic capacitors with capacitance values from 4.7 μF to 47 μF without a feedforward capacitor. For output capacitors from 47 μF to 200 μF a feedforward capacitor of at least 220 pF must be used. The TPS7A7300 is evaluated using an X5R-type, 10- μF ceramic capacitor. Use X5R- and X7R-type capacitors because they have minimal variation in value and ESR over temperature. Maximum ESR must be less than 1 Ω .

As with any regulator, increasing the size of the output capacitor reduces overshoot and undershoot magnitude, but increases duration of the transient response.

7.2.3 Application Curves

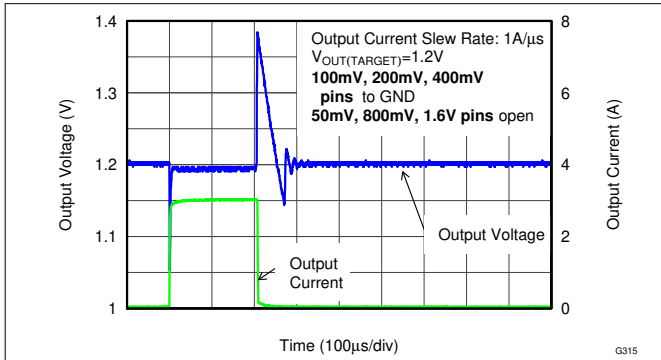

Figure 7-2. Load Transient Response ($V_{OUT} = 1.2\text{ V}$)

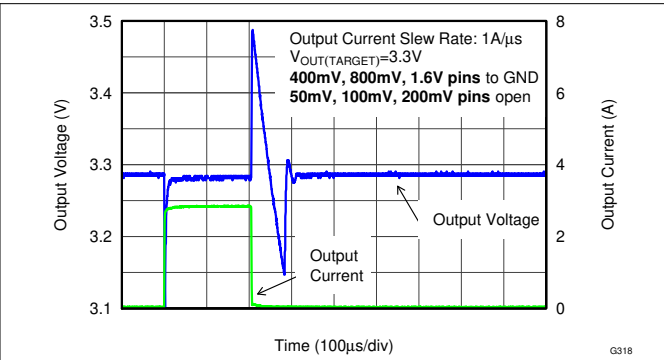

Figure 7-3. Load Transient Response ($V_{OUT} = 3.3\text{ V}$)

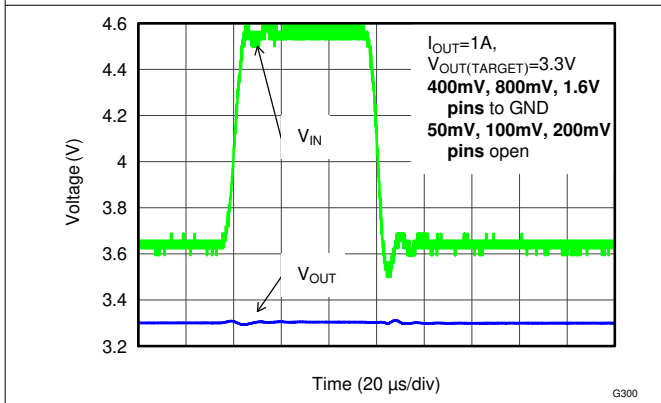

Figure 7-4. Line Transient Response

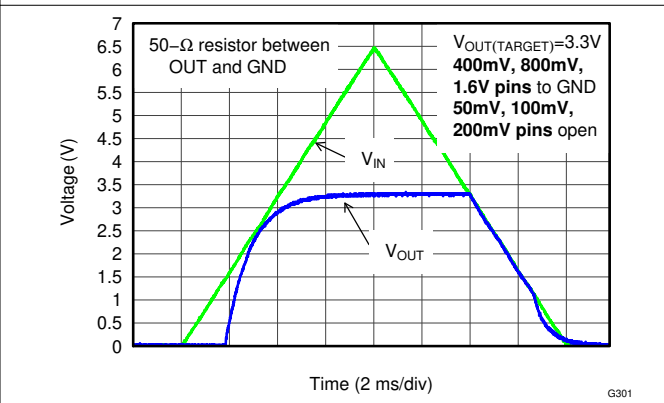

Figure 7-5. Power Up and Power Down ($I_N = E_N$)

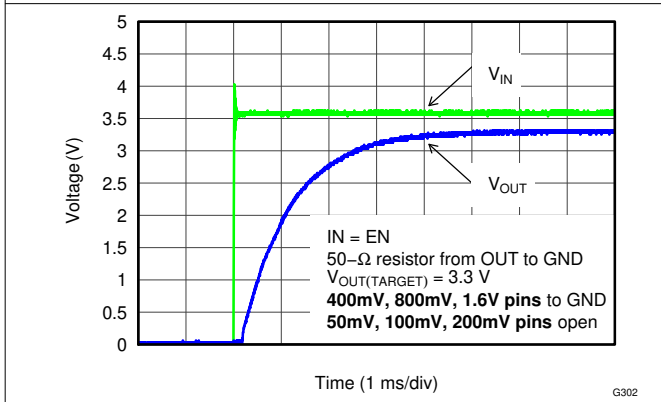

Figure 7-6. Turnon Response ($I_N = E_N$)

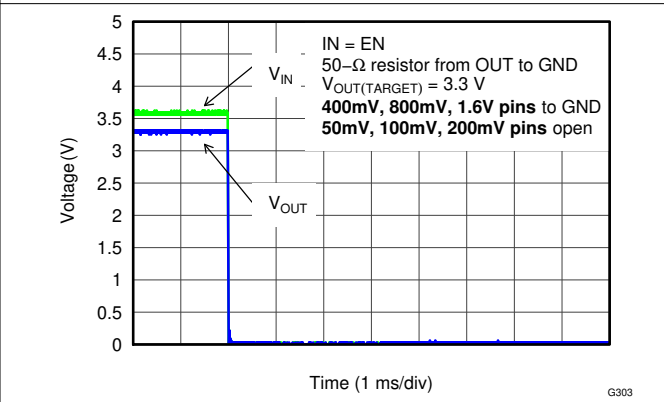

Figure 7-7. Turnoff Response ($I_N = E_N$)

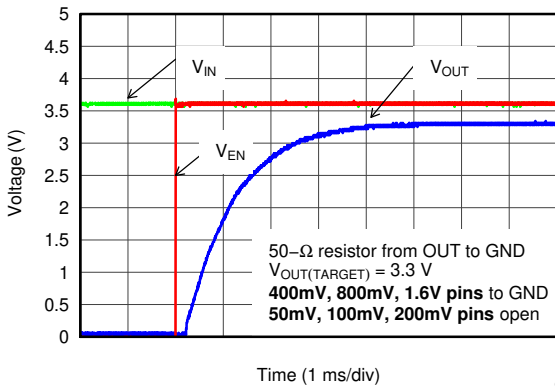

Figure 7-8. EN Pulse On Response (Over Stable V_{IN})

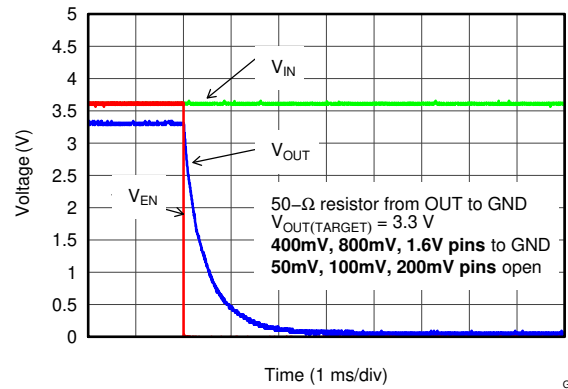

Figure 7-9. EN Pulse Off Response (Over Stable V_{IN})

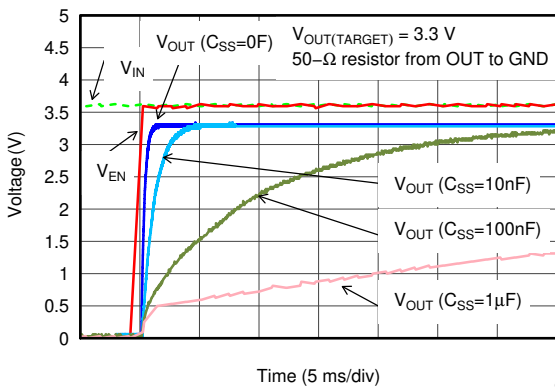

Figure 7-10. Soft-Start Delay vs C_{SS} (Enlarged View)

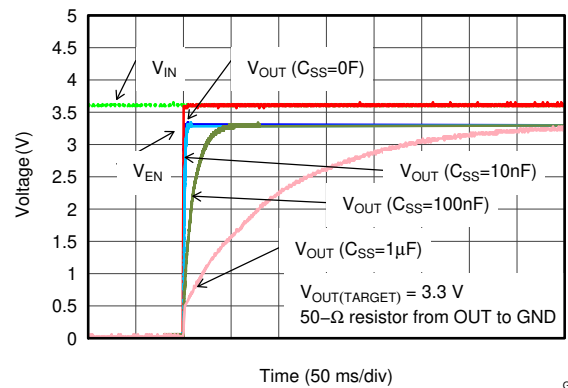

Figure 7-11. Soft-Start Delay vs C_{SS} (Reduced View)

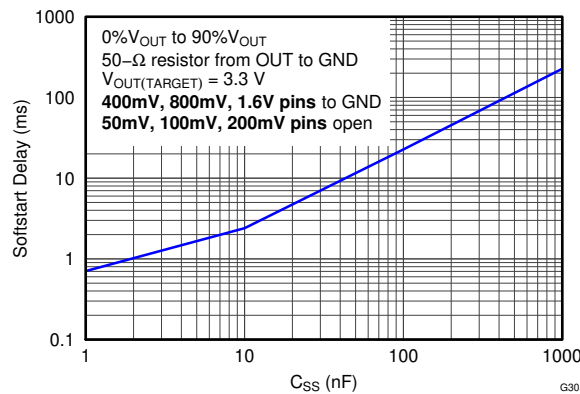

Figure 7-12. Soft-Start Delay vs C_{SS}

7.3 Power Supply Recommendations

This device is designed for operation from an input voltage supply ranging from 1.425 V to 6.5 V. This input supply must be well regulated. The TPS7A7300 fast-transient, low-dropout linear regulator achieves stability with a minimum output capacitance of 4.7 μF ; however, use 10- μF ceramic capacitors for both the input and output to maximize AC performance.

7.4 Layout

7.4.1 Layout Guidelines

- To improve AC performance (such as PSRR, output noise, and transient response), design the board with separate ground planes for IN and OUT, with each ground plane connected only at the GND pin of the device.
- In addition, the ground connection for the output capacitor must connect directly to the GND pin of the device.
- Equivalent series inductance (ESL) and ESR must be minimized to maximize performance and ensure stability.
- Every capacitor must be placed as close as possible to the device and on the same side of the PCB as the regulator.
- Do **not** place any of the capacitors on the opposite side of the PCB from where the regulator is installed.
- The use of vias and long traces is strongly discouraged because these components can impact system performance negatively and even cause instability.
- If possible, and to provide the maximum performance denoted in this product data sheet, use the same layout pattern used for the TPS7A7300 evaluation board, see the [TPS7A7x00EVM-718 Evaluation Module user guide](#).

7.4.1.1 Thermal Considerations

The thermal protection feature disables the output when the junction temperature rises to approximately 160°C, allowing the device to cool. When the junction temperature cools to approximately 140°C, the output circuitry is enabled. Depending on power dissipation, thermal resistance, and ambient temperature, the thermal-protection circuit can cycle on and off. This thermal limit protects the device from damage as a result of overheating.

Any tendency to activate the thermal protection circuit indicates excessive power dissipation or an inadequate heat sink. For reliable operation, junction temperature must be limited to 125°C maximum. To estimate the margin of safety in a complete design (including heat sink), increase the ambient temperature until the thermal protection is triggered; use worst-case loads and signal conditions. For good reliability, thermal protection must trigger at least 35°C above the maximum expected ambient condition of your particular application. This configuration produces a worst-case junction temperature of 125°C at the highest-expected ambient temperature and worst-case load.

The internal-protection circuitry of the TPS7A7300 is designed to protect against overload conditions. This circuitry is not intended to replace proper heat sinking. Continuously running the TPS7A7300 into thermal shutdown degrades device reliability.

7.4.1.2 Power Dissipation

Knowing the device power dissipation and proper sizing of the thermal plane that is connected to the tab or pad is critical to avoiding thermal shutdown and providing reliable operation.

Power dissipation of the device depends on input voltage and load conditions and can be calculated using [Equation 1](#):

$$P_D = (V_{IN} - V_{OUT}) \times I_{OUT} \quad (1)$$

Power dissipation can be minimized and greater efficiency can be achieved by using the lowest possible input voltage necessary to achieve the required output voltage regulation.

On the VQFN (RGW) package, the primary conduction path for heat is through the exposed pad to the PCB. The pad can be connected to ground or be left floating; however, the pad must be attached to an appropriate amount of copper PCB area to make sure the device does not overheat. The maximum junction-to-ambient thermal resistance depends on the maximum ambient temperature, maximum device junction temperature, and power dissipation of the device and can be calculated using [Equation 2](#):

$$R_{\theta JA} = \left(\frac{+125^{\circ}\text{C} - T_A}{P_D} \right) \quad (2)$$

Knowing the maximum $R_{\theta JA}$, the minimum amount of PCB copper area needed for appropriate heat sinking can be estimated using [Figure 7-13](#).

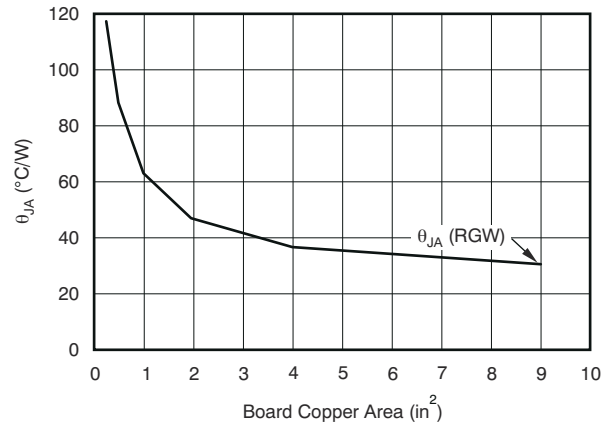

The $R_{\theta JA}$ value at a board size of 9-in² (that is, 3-in × 3-in) is a JEDEC standard.

Figure 7-13. $R_{\theta JA}$ vs Board Size

[Figure 7-13](#) shows the variation of $R_{\theta JA}$ as a function of ground plane copper area in the board. This figure is intended only as a guideline to demonstrate the effects of heat spreading in the ground plane and must not be used to estimate actual thermal performance in real application environments.

Note

When the device is mounted on an application PCB, Ψ_{JT} and Ψ_{JB} must be used as explained in the [Estimating Junction Temperature](#) section.

7.4.1.3 Estimating Junction Temperature

Using the thermal metrics Ψ_{JT} and Ψ_{JB} , as listed in the *Thermal Information* table, the junction temperature can be estimated with corresponding formulas (given in [Equation 3](#)). For backwards compatibility, an older $\theta_{JC, Top}$ parameter is listed as well.

$$\begin{aligned} \Psi_{JT}: T_J &= T_T + \Psi_{JT} \cdot P_D \\ \Psi_{JB}: T_J &= T_B + \Psi_{JB} \cdot P_D \end{aligned} \quad (3)$$

where:

- P_D is the power dissipation shown by [Equation 2](#)
- T_T is the temperature at the center-top of the device package
- T_B is the PCB temperature measured 1 mm away from the device package *on the PCB surface* (see [Figure 7-14](#))

Note

Both T_T and T_B can be measured on actual application boards using a thermo-gun (an infrared thermometer).

For more information about measuring T_T and T_B , see the [Using New Thermal Metrics](#) application note.

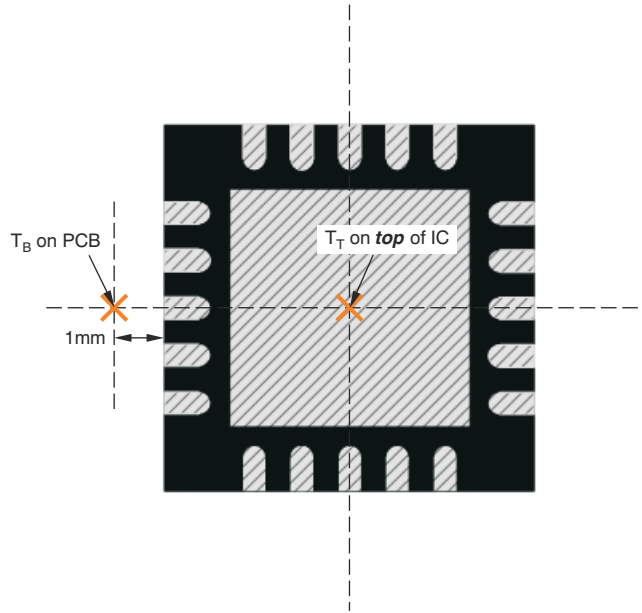

(a) Example RGW (QFN) Package Measurement

Figure 7-14. Measuring Points For T_T and T_B

From [Figure 7-15](#), the new thermal metrics (Ψ_{JT} and Ψ_{JB}) are shown to have very little dependency on board size. That is, using Ψ_{JT} or Ψ_{JB} with [Equation 3](#) is a good way to estimate T_J by simply measuring T_T or T_B , regardless of the application board size.

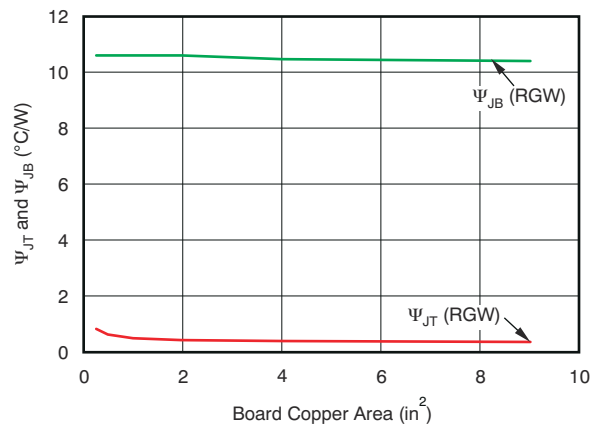
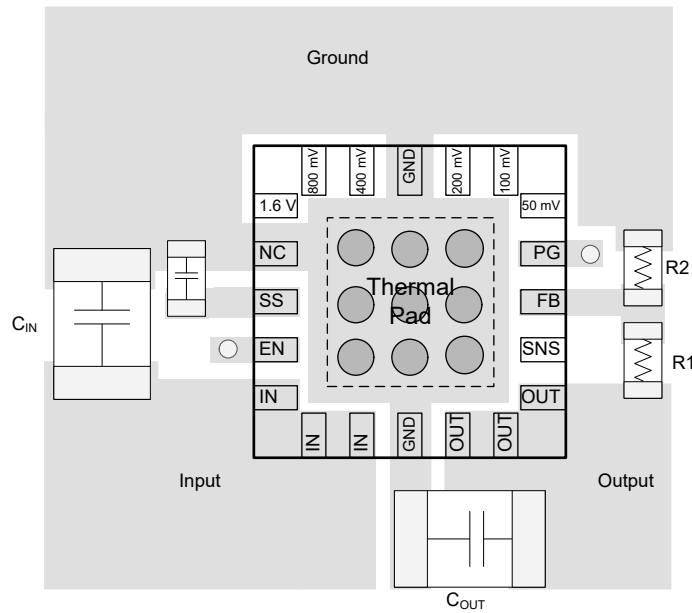

Figure 7-15. Ψ_{JT} And Ψ_{JB} vs Board Size

For a more detailed discussion of why TI does not recommend using $\theta_{JC(top)}$ to determine thermal characteristics, see the [Using New Thermal Metrics application note](#). For further information, see the [Semiconductor and IC Package Thermal Metrics application note](#).

7.4.2 Layout Example



- Notes: C_{in} and C_{out} are 0805 packages
- C_{SS}, R₁, and R₂ are 0402 packages
- R₁ and R₂ only needed for adjustable operation
- Denotes a via to a connection made on another layer

Figure 7-16. TPS7A7300 Recommended Layout

8 Device And Documentation Support

8.1 Documentation Support

8.1.1 Related Documentation

For related documentation see the following:

- Texas Instruments, [Pros and Cons of Using a Feedforward Capacitor with a Low-Dropout Regulator application note](#)
- Texas Instruments, [Using New Thermal Metrics application note](#)
- Texas Instruments, [TPS7A7x00EVM-718 Evaluation Module user guide](#)
- Texas Instruments, [Semiconductor and IC Package Thermal Metrics application note](#)

8.2 Receiving Notification of Documentation Updates

To receive notification of documentation updates, navigate to the device product folder on ti.com. Click on *Notifications* to register and receive a weekly digest of any product information that has changed. For change details, review the revision history included in any revised document.

8.3 Support Resources

[TI E2E™ support forums](#) are an engineer's go-to source for fast, verified answers and design help — straight from the experts. Search existing answers or ask your own question to get the quick design help you need.

Linked content is provided "AS IS" by the respective contributors. They do not constitute TI specifications and do not necessarily reflect TI's views; see TI's [Terms of Use](#).

8.4 Trademarks

TI E2E™ is a trademark of Texas Instruments.
All trademarks are the property of their respective owners.

8.5 Electrostatic Discharge Caution



This integrated circuit can be damaged by ESD. Texas Instruments recommends that all integrated circuits be handled with appropriate precautions. Failure to observe proper handling and installation procedures can cause damage.

ESD damage can range from subtle performance degradation to complete device failure. Precision integrated circuits may be more susceptible to damage because very small parametric changes could cause the device not to meet its published specifications.

8.6 Glossary

[TI Glossary](#) This glossary lists and explains terms, acronyms, and definitions.

9 Revision History

NOTE: Page numbers for previous revisions may differ from page numbers in the current version.

Changes from October 4, 2023 to October 30, 2023 (from Revision E (December 2015) to Revision F (October 2023))

	Page
• Added links to <i>Applications</i> section.....	1
• Changed name of section from <i>Enable and Shutdown the Device</i> to <i>Enable</i>	21
• Changed SS and EN position in <i>Layout Example</i> to match device pinout.....	30

Changes from Revision D (January 2013) to Revision E (December 2015)

	Page
• Added <i>ESD Ratings</i> table, <i>Feature Description</i> section, <i>Device Functional Modes</i> , <i>Application and Implementation</i> section, <i>Power Supply Recommendations</i> section, <i>Layout</i> section, <i>Device and Documentation Support</i> section, and <i>Mechanical, Packaging, and Orderable Information</i> section	1

10 Mechanical, Packaging, And Orderable Information

The following pages include mechanical, packaging, and orderable information. This information is the most current data available for the designated devices. This data is subject to change without notice and revision of this document. For browser-based versions of this data sheet, refer to the left-hand navigation.

PACKAGING INFORMATION

Orderable Device	Status (1)	Package Type	Package Drawing	Pins	Package Qty	Eco Plan (2)	Lead finish/ Ball material (6)	MSL Peak Temp (3)	Op Temp (°C)	Device Marking (4/5)	Samples
TPS7A7300RGWR	ACTIVE	VQFN	RGW	20	3000	RoHS & Green	NIPDAU	Level-2-260C-1 YEAR	-40 to 125	SBR	Samples
TPS7A7300RGWT	ACTIVE	VQFN	RGW	20	250	RoHS & Green	NIPDAU	Level-2-260C-1 YEAR	-40 to 125	SBR	Samples

(1) The marketing status values are defined as follows:

ACTIVE: Product device recommended for new designs.

LIFEBUY: TI has announced that the device will be discontinued, and a lifetime-buy period is in effect.

NRND: Not recommended for new designs. Device is in production to support existing customers, but TI does not recommend using this part in a new design.

PREVIEW: Device has been announced but is not in production. Samples may or may not be available.

OBSOLETE: TI has discontinued the production of the device.

(2) **RoHS:** TI defines "RoHS" to mean semiconductor products that are compliant with the current EU RoHS requirements for all 10 RoHS substances, including the requirement that RoHS substance do not exceed 0.1% by weight in homogeneous materials. Where designed to be soldered at high temperatures, "RoHS" products are suitable for use in specified lead-free processes. TI may reference these types of products as "Pb-Free".

RoHS Exempt: TI defines "RoHS Exempt" to mean products that contain lead but are compliant with EU RoHS pursuant to a specific EU RoHS exemption.

Green: TI defines "Green" to mean the content of Chlorine (Cl) and Bromine (Br) based flame retardants meet JS709B low halogen requirements of <=1000ppm threshold. Antimony trioxide based flame retardants must also meet the <=1000ppm threshold requirement.

(3) MSL, Peak Temp. - The Moisture Sensitivity Level rating according to the JEDEC industry standard classifications, and peak solder temperature.

(4) There may be additional marking, which relates to the logo, the lot trace code information, or the environmental category on the device.

(5) Multiple Device Markings will be inside parentheses. Only one Device Marking contained in parentheses and separated by a "~" will appear on a device. If a line is indented then it is a continuation of the previous line and the two combined represent the entire Device Marking for that device.

(6) Lead finish/Ball material - Orderable Devices may have multiple material finish options. Finish options are separated by a vertical ruled line. Lead finish/Ball material values may wrap to two lines if the finish value exceeds the maximum column width.

Important Information and Disclaimer:The information provided on this page represents TI's knowledge and belief as of the date that it is provided. TI bases its knowledge and belief on information provided by third parties, and makes no representation or warranty as to the accuracy of such information. Efforts are underway to better integrate information from third parties. TI has taken and continues to take reasonable steps to provide representative and accurate information but may not have conducted destructive testing or chemical analysis on incoming materials and chemicals. TI and TI suppliers consider certain information to be proprietary, and thus CAS numbers and other limited information may not be available for release.

In no event shall TI's liability arising out of such information exceed the total purchase price of the TI part(s) at issue in this document sold by TI to Customer on an annual basis.

TAPE AND REEL INFORMATION

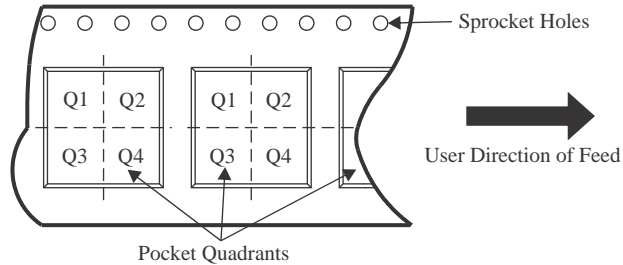
QUADRANT ASSIGNMENTS FOR PIN 1 ORIENTATION IN TAPE

*All dimensions are nominal

Device	Package Type	Package Drawing	Pins	SPQ	Reel Diameter (mm)	Reel Width W1 (mm)	A0 (mm)	B0 (mm)	K0 (mm)	P1 (mm)	W (mm)	Pin1 Quadrant
TPS7A7300RGWR	VQFN	RGW	20	3000	330.0	12.4	5.3	5.3	1.1	8.0	12.0	Q2
TPS7A7300RGWT	VQFN	RGW	20	250	180.0	12.4	5.3	5.3	1.1	8.0	12.0	Q2

TAPE AND REEL BOX DIMENSIONS

*All dimensions are nominal

Device	Package Type	Package Drawing	Pins	SPQ	Length (mm)	Width (mm)	Height (mm)
TPS7A7300RGWR	VQFN	RGW	20	3000	346.0	346.0	33.0
TPS7A7300RGWT	VQFN	RGW	20	250	210.0	185.0	35.0

GENERIC PACKAGE VIEW

RGW 20

VQFN - 1 mm max height

5 x 5, 0.65 mm pitch

PLASTIC QUAD FLATPACK - NO LEAD

This image is a representation of the package family, actual package may vary.
Refer to the product data sheet for package details.

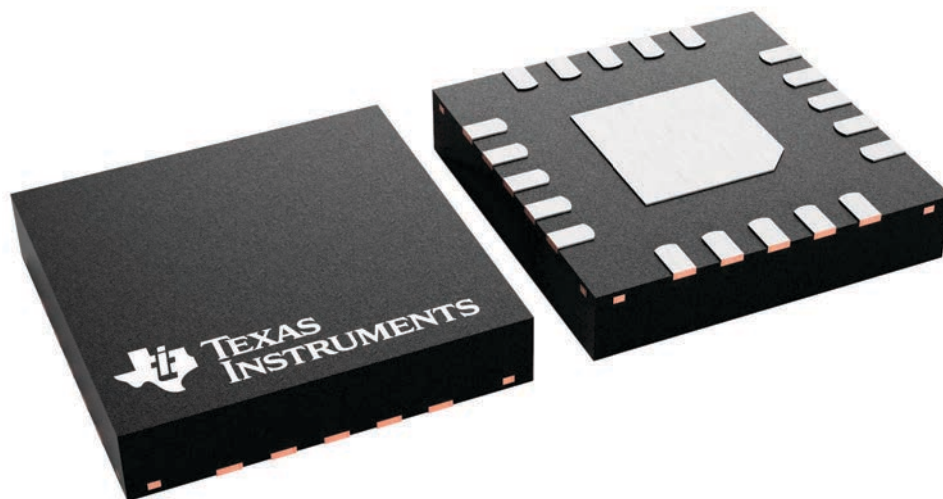

4227157/A

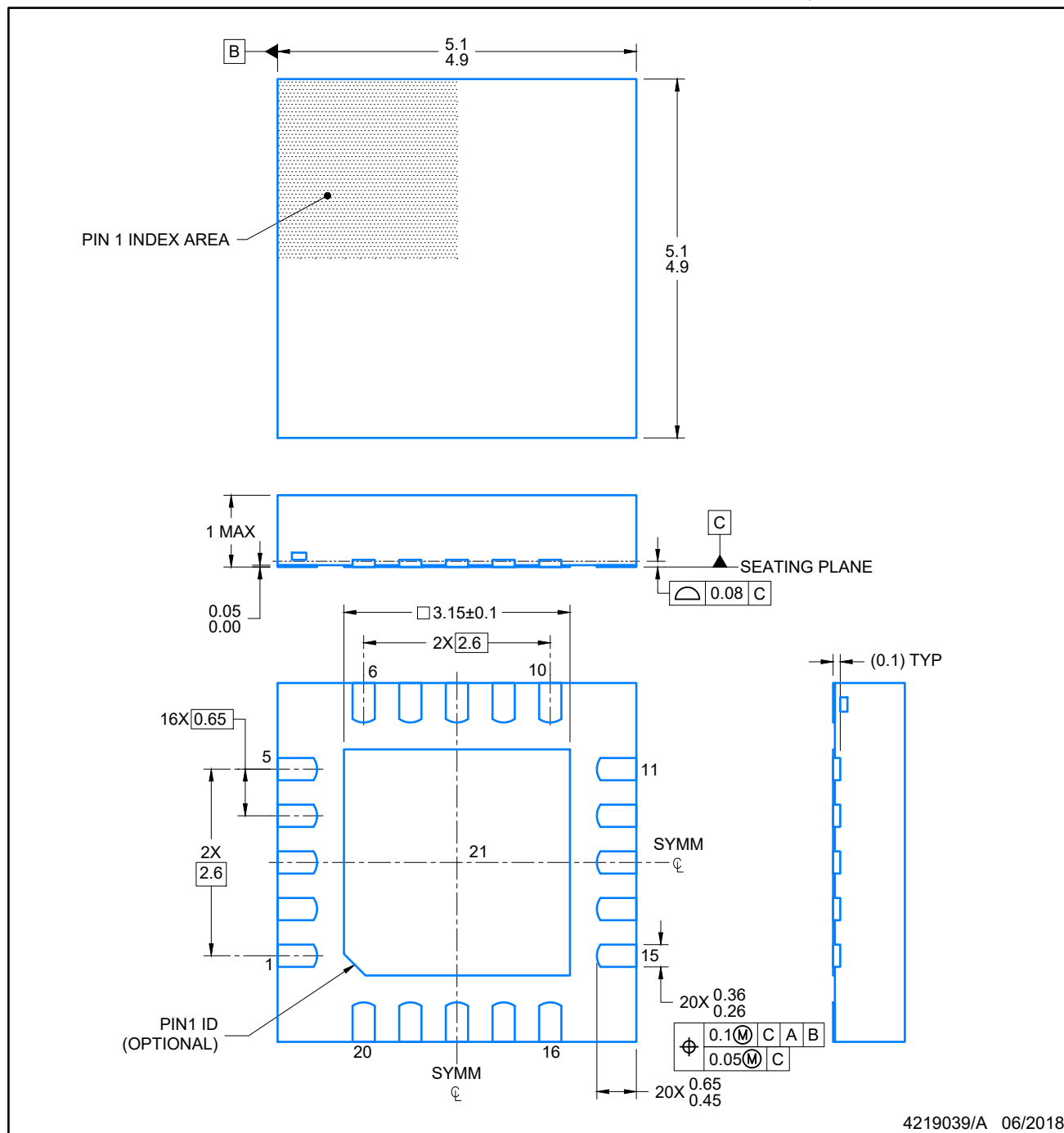

NOTES:

1. All linear dimensions are in millimeters. Any dimensions in parenthesis are for reference only. Dimensioning and tolerancing per ASME Y14.5M.
2. This drawing is subject to change without notice.
3. The package thermal pad must be soldered to the printed circuit board for optimal thermal and mechanical performance.

EXAMPLE STENCIL DESIGN

VQFN - 1 mm max height

RGW0020A

PLASTIC QUAD FLATPACK-NO LEAD

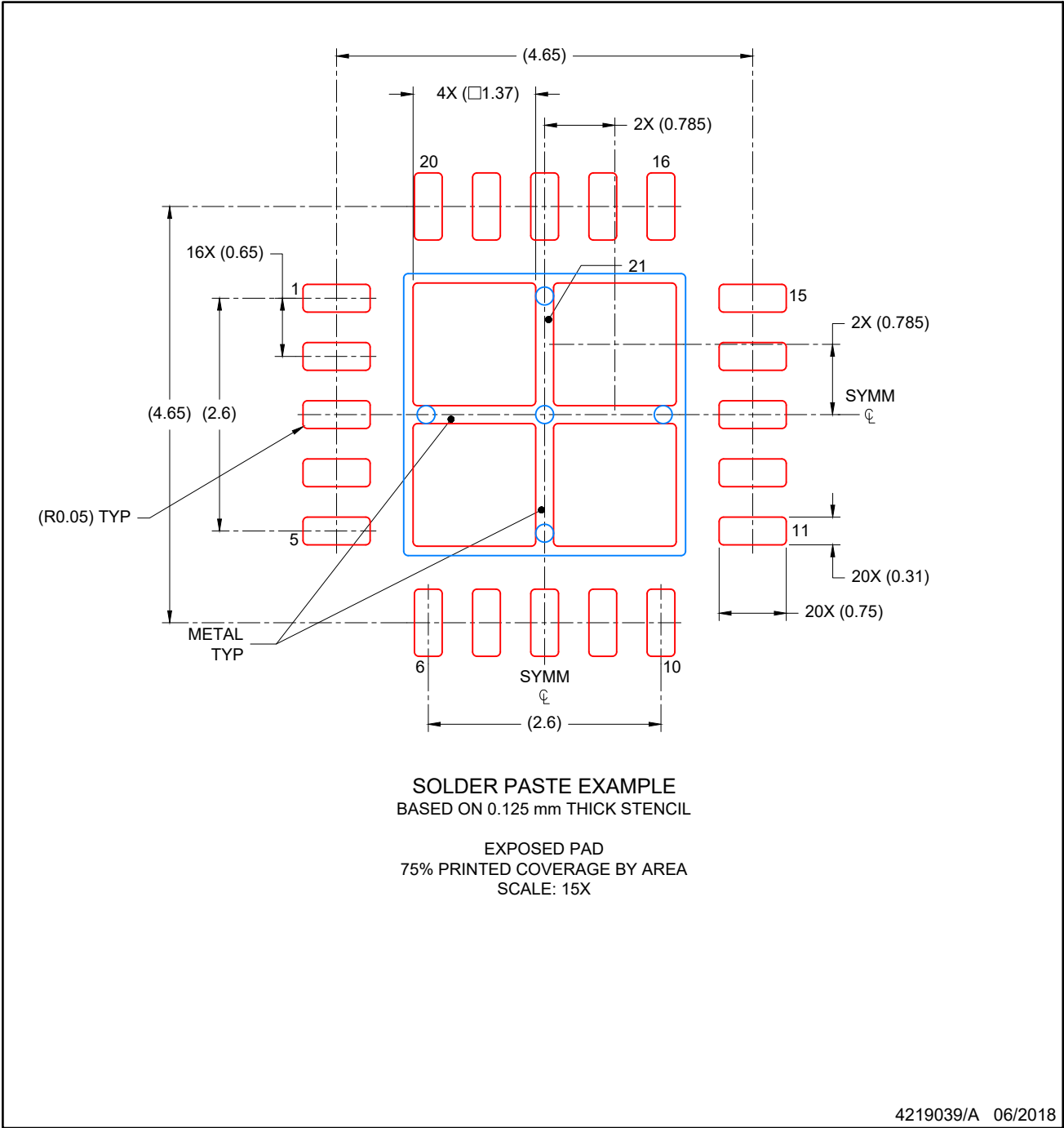

NOTES: (continued)

- 6. Laser cutting apertures with trapezoidal walls and rounded corners may offer better paste release. IPC-7525 may have alternate design recommendations.

IMPORTANT NOTICE AND DISCLAIMER

TI PROVIDES TECHNICAL AND RELIABILITY DATA (INCLUDING DATA SHEETS), DESIGN RESOURCES (INCLUDING REFERENCE DESIGNS), APPLICATION OR OTHER DESIGN ADVICE, WEB TOOLS, SAFETY INFORMATION, AND OTHER RESOURCES "AS IS" AND WITH ALL FAULTS, AND DISCLAIMS ALL WARRANTIES, EXPRESS AND IMPLIED, INCLUDING WITHOUT LIMITATION ANY IMPLIED WARRANTIES OF MERCHANTABILITY, FITNESS FOR A PARTICULAR PURPOSE OR NON-INFRINGEMENT OF THIRD PARTY INTELLECTUAL PROPERTY RIGHTS.

These resources are intended for skilled developers designing with TI products. You are solely responsible for (1) selecting the appropriate TI products for your application, (2) designing, validating and testing your application, and (3) ensuring your application meets applicable standards, and any other safety, security, regulatory or other requirements.

These resources are subject to change without notice. TI grants you permission to use these resources only for development of an application that uses the TI products described in the resource. Other reproduction and display of these resources is prohibited. No license is granted to any other TI intellectual property right or to any third party intellectual property right. TI disclaims responsibility for, and you will fully indemnify TI and its representatives against, any claims, damages, costs, losses, and liabilities arising out of your use of these resources.



TI's products are provided subject to [TI's Terms of Sale](#) or other applicable terms available either on [ti.com](https://www.ti.com) or provided in conjunction with such TI products. TI's provision of these resources does not expand or otherwise alter TI's applicable warranties or warranty disclaimers for TI products.

TI objects to and rejects any additional or different terms you may have proposed.





Mailing Address: Texas Instruments, Post Office Box 655303, Dallas, Texas 75265
Copyright © 2024, Texas Instruments Incorporated

Looking for pricing, stock, or lifecycle information?

Click below to explore more details on WIN SOURCE:

-  [View TPS7A7300RGWR on WIN SOURCE](#)
-  [Texas Instruments](#) Information

Optimize Your Supply Chain with WIN SOURCE Solutions

-  Global Sourcing Solution
-  Obsolete Management
-  Cost Control Management
-  Shortage Management
-  Alternative Solution
-  Excess Inventory Management