

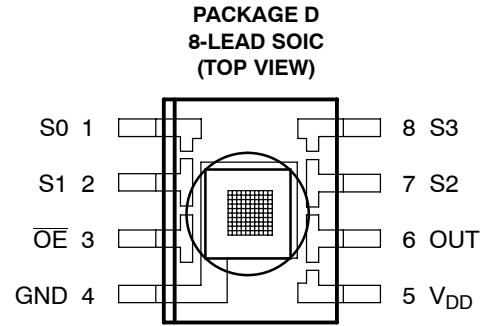

**THE DATASHEET OF
TSL230RD-TR**



- High-Resolution Conversion of Light Intensity to Frequency With No External Components
- Programmable Sensitivity and Full-Scale Output Frequency
- Communicates Directly With a Microcontroller
- High Irradiance Responsivity . . . 790 Hz/($\mu\text{W}/\text{cm}^2$) Typical at 640 nm
- Single-Supply Operation . . . 2.7 V to 5.5 V
- Power-Down Feature . . . 5 μA Typical
- Nonlinearity Error Typically 0.2% at 100 kHz
- Stable 200 ppm/ $^{\circ}\text{C}$ Temperature Coefficient
- Low-Profile Lead (Pb) Free and RoHS Compliant Surface-Mount Package



Description

The TSL230RD, TSL230ARD, and TSL230BRD programmable light-to-frequency converters combine a configurable silicon photodiode and a current-to-frequency converter on single monolithic CMOS integrated circuit. The output can be either a pulse train or a square wave (50% duty cycle) with frequency directly proportional to light intensity. Device sensitivity is selectable in three ranges, providing two decades of adjustment. The full-scale output frequency can be scaled by one of four preset values. All inputs and the output are TTL compatible, allowing direct two-way communication with a microcontroller for programming and output interface. The output enable ($\overline{\text{OE}}$) places the output in the high-impedance state for multiple-unit sharing of a microcontroller input line.

The devices are available with absolute output frequency tolerances of $\pm 10\%$ (TSL230BRD), $\pm 15\%$ (TSL230ARD), and $\pm 20\%$ (TSL230RD). They have been temperature compensated for the ultraviolet-to-visible light range of 320 nm to 700 nm and respond over the light range of 320 nm to 1050 nm. The devices are characterized over the temperature range of -25°C to 70°C .

Functional Block Diagram

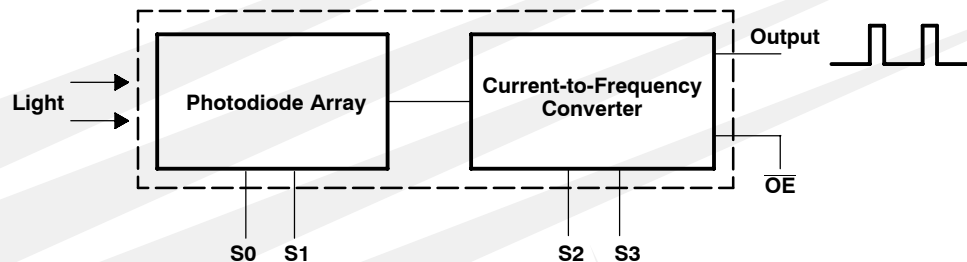

TSL230RD, TSL230ARD, TSL230BRD PROGRAMMABLE LIGHT-TO-FREQUENCY CONVERTERS

TAOS054P – OCTOBER 2007

Terminal Functions

TERMINAL NAME	NO.	TYPE	DESCRIPTION
GND	4		Ground
\overline{OE}	3	I	Enable for f_O (active low)
OUT	6	O	Scaled-frequency (f_O) output
S0, S1	1, 2	I	Sensitivity-select inputs
S2, S3	7, 8	I	f_O scaling-select inputs
V _{DD}	5		Supply voltage

Selectable Options

S1	S0	SENSITIVITY
L	L	Power down
L	H	1x
H	L	10x
H	H	100x

S3	S2	f_O SCALING (divide-by)
L	L	1
L	H	2
H	L	10
H	H	100

Available Options

DEVICE	T _A	PACKAGE – LEADS	PACKAGE DESIGNATOR	ORDERING NUMBER
TSL230RD	-25°C to 70°C	SOIC-8	D	TSL230RD
TSL230ARD	-25°C to 70°C	SOIC-8	D	TSL230ARD
TSL230BRD	-25°C to 70°C	SOIC-8	D	TSL230BRD

Absolute Maximum Ratings over operating free-air temperature range (unless otherwise noted)[†]

Supply voltage, V _{DD} (see Note 1)	6 V
Input voltage range, all inputs, V _I	-0.3 V to V _{DD} + 0.3 V
Operating free-air temperature range, T _A	-40°C to 85°C
Storage temperature range	-40°C to 85°C
Solder conditions in accordance with JEDEC J-STD-020A, maximum temperature (see Note 2)	260°C

[†] Stresses beyond those listed under “absolute maximum ratings” may cause permanent damage to the device. These are stress ratings only, and functional operation of the device at these or any other conditions beyond those indicated under “recommended operating conditions” is not implied. Exposure to absolute-maximum-rated conditions for extended periods may affect device reliability.

- NOTES: 1. All voltage values are with respect to GND.
2. The device may be hand soldered provided that heat is applied only to the solder pad and no contact is made between the tip of the solder iron and the device lead. The maximum time heat should be applied to the device is 5 seconds.

Recommended Operating Conditions

	MIN	NOM	MAX	UNIT
Supply voltage, V _{DD}	2.7	5	5.5	V
High-level input voltage, V _{IH}	V _{DD} = 4.5 V to 5.5 V		V _{DD}	V
Low-level input voltage, V _{IL}	V _{DD} = 4.5 V to 5.5 V		0.8	V
Operating free-air temperature range, T _A	-25		70	°C

TSL230RD, TSL230ARD, TSL230BRD PROGRAMMABLE LIGHT-TO-FREQUENCY CONVERTERS

TAOS054P – OCTOBER 2007

Electrical Characteristics at $T_A = 25^\circ\text{C}$, $V_{DD} = 5\text{ V}$ (unless otherwise noted)

PARAMETER		TEST CONDITIONS	MIN	TYP	MAX	UNIT
V_{OH}	High-level output voltage	$I_{OH} = -4\text{ mA}$	4	4.5		V
V_{OL}	Low-level output voltage	$I_{OL} = 4\text{ mA}$		0.25	0.4	V
I_{IH}	High-level input current				5	μA
I_{IL}	Low-level input current				5	μA
I_{DD}	Supply current	Power-on mode		2	3	mA
		Power-down mode		5	12	μA
F.S.	Full-scale frequency (See Note 3)	$S0=S1=H, S2=S3=L$	1.1			MHz
	Temperature coefficient of output frequency	$\lambda \leq 700\text{ nm}$ (See Note 4)		± 200		ppm/ $^\circ\text{C}$
k_{SVS}	Supply voltage sensitivity	$V_{DD} = 5\text{ V} \pm 10\%$		± 0.5		%/V

- NOTES: 3. Full-scale frequency is the maximum operating frequency of the device without saturation.
 4. The temperature coefficient of output frequency is measured with constant irradiance as the temperature is varied between -25°C and 70°C . The constant irradiance is sufficiently high that the output frequency is much greater than the dark frequency over the entire temperature range.

Operating Characteristics at $V_{DD} = 5\text{ V}$, $T_A = 25^\circ\text{C}$, $E_e = 126\ \mu\text{W}/\text{cm}^2$, $\lambda_p = 640\text{ nm}$ (unless otherwise noted)

PARAMETER	TEST CONDITIONS	TSL230RD			TSL230ARD			TSL230BRD			UNIT	
		MIN	TYP	MAX	MIN	TYP	MAX	MIN	TYP	MAX		
f_O	Output frequency	$S0 = S1 = H,$ $S2 = S3 = L$	80	100	120	85	100	115	90	100	110	kHz
		$S1 = H,$ $S0 = S2 = S3 = L$	8	10	12	8.5	10	11.5	9	10	11	
		$S0 = H,$ $S1 = S2 = S3 = L$	0.8	1	1.2	0.85	1	1.15	0.9	1	1	
		$S0 = S1 = S2 = H,$ $S3 = L$	40	50	60	42.5	50	57.5	45	50	55	
		$S0 = S1 = S3 = H,$ $S2 = L$	8	10	12	8.5	10	11.5	9	10	11	
		$S0 = S1 = S2 = S3 = H$	0.8	1	1.2	0.85	1	1.15	0.9	1	1.1	
f_D	Dark frequency	$E_e = 0,$ $S0 = S1 = H,$ $S2 = S3 = L$		0.4	10		0.4	10		0.4	10	Hz
R_e	Responsivity	$S0 = S1 = H,$ $S2 = S3 = L$		0.79			0.79			0.79		kHz/ ($\mu\text{W}/\text{cm}^2$)
t_w	Output pulse duration	$S2 = S3 = L$	125		600	125		600	125		600	ns
		$S2$ or $S3 = H$		$1/2f_O$			$1/2f_O$			$1/2f_O$		s
Nonlinearity (See Notes 5 and 6)		$f_O = 0\text{ MHz to }10\text{ kHz}$	$\pm 0.1\%$			$\pm 0.1\%$			$\pm 0.1\%$			%F.S.
		$f_O = 0\text{ MHz to }100\text{ kHz}$	$\pm 0.2\%$			$\pm 0.2\%$			$\pm 0.2\%$			
		$f_O = 0\text{ MHz to }1\text{ MHz}$	$\pm 0.5\%$			$\pm 0.5\%$			$\pm 0.5\%$			
Recovery from power down				100			100			100	μs	
Step response to full-scale step input		1 pulse of new frequency plus $1\ \mu\text{s}$										
Response time to programming change		2 periods of new principal frequency plus $1\ \mu\text{s}$ (Note 7)										
Response time to output enable (\overline{OE})			50	150		50	150		50	150	ns	

- NOTES: 5. Nonlinearity is defined as the deviation of f_O from a straight line between zero and full scale, expressed as a percent of full scale.
 6. Nonlinearity test condition: $S0 = S1 = H, S2 = S3 = L$.
 7. Principal frequency is the internal oscillator frequency, equivalent to divide-by-1 output selection.

TSL230RD, TSL230ARD, TSL230BRD PROGRAMMABLE LIGHT-TO-FREQUENCY CONVERTERS

TAOS054P – OCTOBER 2007

TYPICAL CHARACTERISTICS

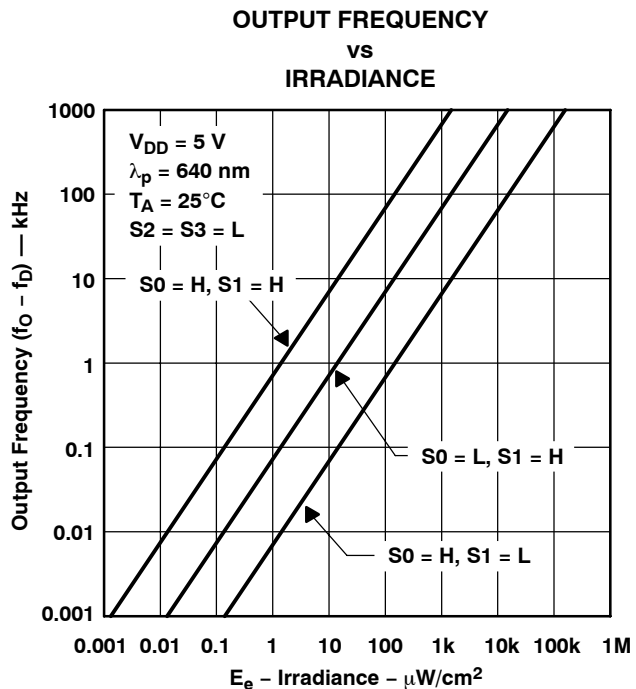

Figure 1

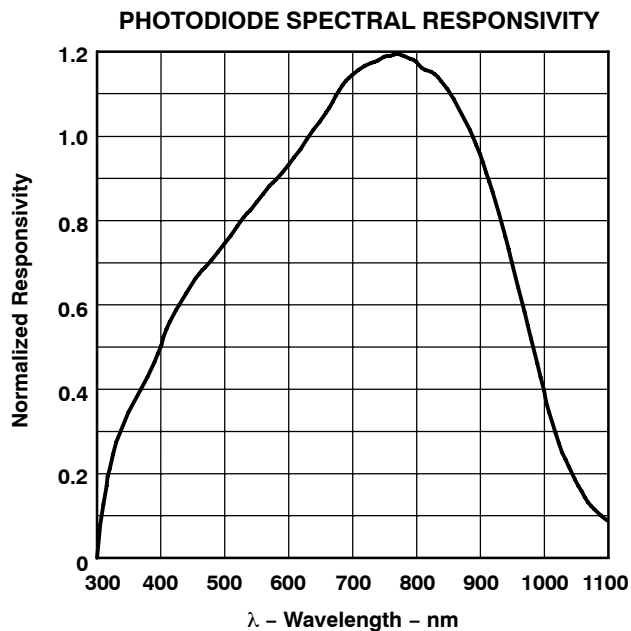

Figure 2

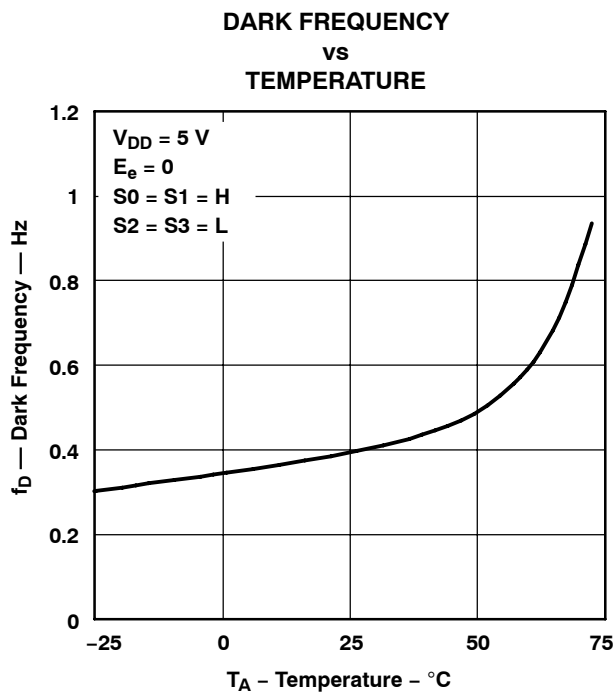

Figure 3

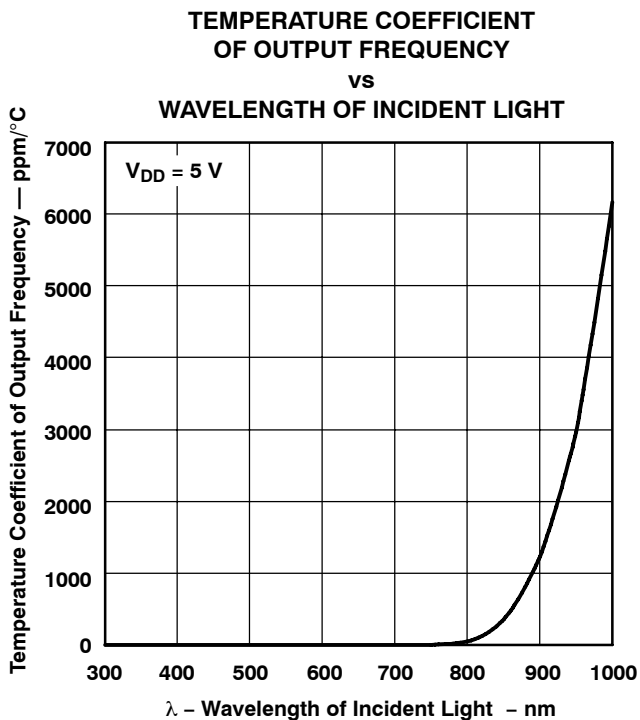

Figure 4



TYPICAL CHARACTERISTICS

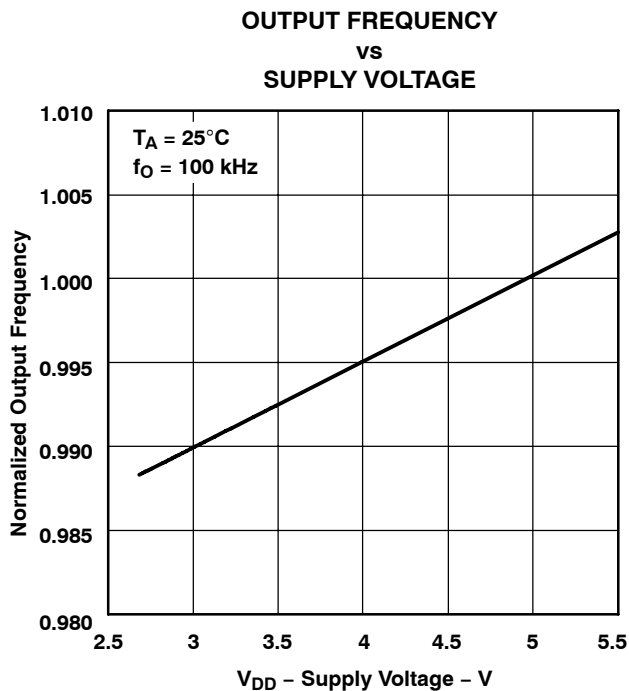

Figure 5

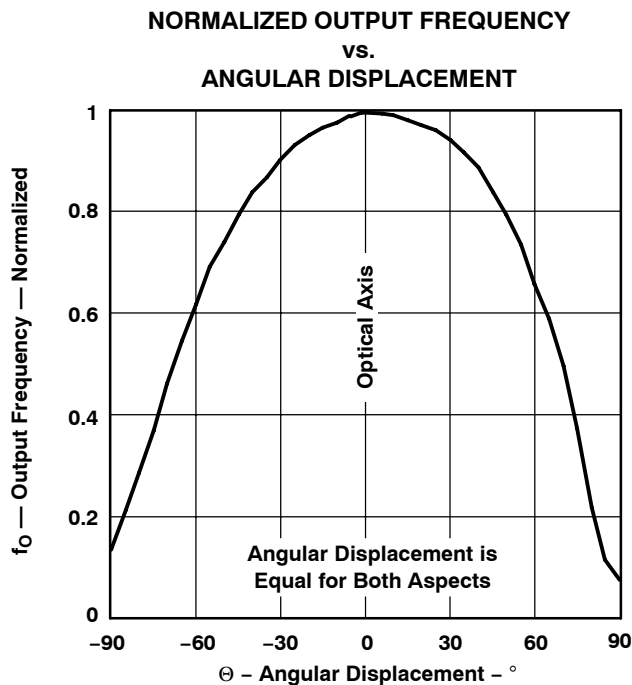

Figure 6

TSL230RD, TSL230ARD, TSL230BRD PROGRAMMABLE LIGHT-TO-FREQUENCY CONVERTERS

TAOS054P – OCTOBER 2007

APPLICATION INFORMATION

Power-Supply Considerations

Power-supply lines must be decoupled by a 0.01- μ F to 0.1- μ F capacitor with short leads placed close to the TSL230RD device package. A low-noise power supply is required to minimize jitter on output pulses.

Device Operational Details

The frequency at the output pin (OUT) is given by:

$$f_O = f_D + (R_e) (E_e)$$

where:

- f_O is the output frequency
- f_D is the output frequency for dark condition ($E_e = 0$)
- R_e is the device responsivity for a given wavelength of light given in kHz/(μ W/cm²)
- E_e is the incident irradiance in μ W/cm²

f_D is an output frequency resulting from leakage currents. As shown in the equation above, this frequency represents a light-independent term in the total output frequency f_O . At very low light levels, this dark frequency can be a significant portion of f_O . The dark frequency is temperature dependent. For optimum performance of any given device over the full output range, the value of f_D should be measured (in the absence of light) and later subtracted from subsequent light measurement (see Figure 1).

Input Interface

A low-impedance electrical connection between the device \overline{OE} pin and the device GND pin is required for improved noise immunity.

Output Interface

The output of the device is designed to drive a standard TTL or CMOS logic input over short distances. If lines greater than 12 inches are used on the output, a buffer or line driver is recommended.

Sensitivity Adjustment

Sensitivity is controlled by two logic inputs, S0 and S1. Sensitivity is adjusted using an electronic iris technique — effectively an aperture control — to change the response of the device to a given amount of light. The sensitivity can be set to one of three levels: 1 \times , 10 \times , or 100 \times , providing two decades of adjustment. This allows the responsivity of the device to be optimized to a given light level while preserving the full-scale output-frequency range. Changing of sensitivity also changes the effective photodiode area by the same factor.

APPLICATION INFORMATION

Output-Frequency Scaling

Output-frequency scaling is controlled by two logic inputs, S2 and S3. Scaling is accomplished on chip by internally connecting the pulse-train output of the converter to a series of frequency dividers. Divided outputs available are divide-by 2, 10, 100, and 1 (no division). Divided outputs are 50 percent-duty-cycle square waves while the direct output (divide-by 1) is a fixed-pulse-width pulse train. Because division of the output frequency is accomplished by counting pulses of the principal (divide-by 1) frequency, the final-output period represents an average of n (where n is 2, 10, or 100) periods of the principal frequency. The output-scaling-counter registers are cleared upon the next pulse of the principal frequency after any transition of the S0, S1, S2, S3, or OE lines. The output goes high upon the next subsequent pulse of the principal frequency, beginning a new valid period. This minimizes the time delay between a change on the input lines and the resulting new output period in the divided output modes. In contrast with the sensitivity adjust, use of the divided outputs lowers both the full-scale frequency and the dark frequency by the selected scale factor.

The frequency-scaling function allows the output range to be optimized for a variety of measurement techniques. The divide-by-1 or straight-through output can be used with a frequency counter, pulse accumulator, or high-speed timer (period measurement). The divided-down outputs may be used where only a slower frequency counter is available, such as a low-cost microcontroller, or where period measurement techniques are used. The divide-by-10 and divide-by-100 outputs provide lower frequency ranges for high resolution-period measurement.

Measuring the Frequency

The choice of interface and measurement technique depends on the desired resolution and data acquisition rate. For maximum data-acquisition rate, period-measurement techniques are used.

Using the divide-by-2 output, data can be collected at a rate of twice the output frequency or one data point every microsecond for full-scale output. Period measurement requires the use of a fast reference clock with available resolution directly related to reference-clock rate. Output scaling can be used to increase the resolution for a given clock rate or to maximize resolution as the light input changes. Period measurement is used to measure rapidly varying light levels or to make a very fast measurement of a constant light source.

Maximum resolution and accuracy may be obtained using frequency-measurement, pulse-accumulation, or integration techniques. Frequency measurements provide the added benefit of averaging out random or high-frequency variations (jitter) resulting from noise in the light signal or from noise in the power supply. Resolution is limited mainly by available counter registers and allowable measurement time. Frequency measurement is well suited for slowly varying or constant light levels and for reading average light levels over short periods of time. Integration (the accumulation of pulses over a very long period of time) can be used to measure exposure, the amount of light present in an area over a given time period.

TSL230RD, TSL230ARD, TSL230BRD PROGRAMMABLE LIGHT-TO-FREQUENCY CONVERTERS

TAOS054P – OCTOBER 2007

APPLICATION INFORMATION

PCB Pad Layout

Suggested PCB pad layout guidelines for the D package are shown in Figure 7.

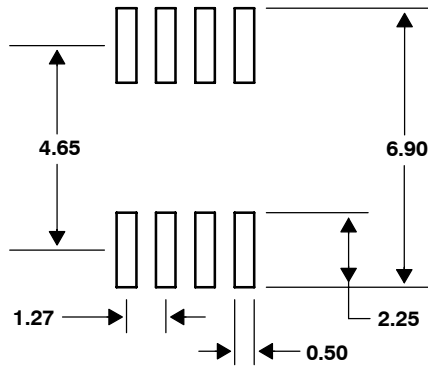

- NOTES: A. All linear dimensions are in millimeters.
B. This drawing is subject to change without notice.

Figure 7. Suggested D Package PCB Layout

TSL230RD, TSL230ARD, TSL230BRD PROGRAMMABLE LIGHT-TO-FREQUENCY CONVERTERS

TAOS054P – OCTOBER 2007

MECHANICAL DATA

This SOIC package consists of an integrated circuit mounted on a lead frame and encapsulated with an electrically nonconductive clear plastic compound. The TSL230RD has a 10 × 10 array of photodiodes with a total size of 0.96 mm by 0.96 mm. The photodiodes are 0.084 mm × 0.084 mm in size and are positioned on 0.096 mm centers.

PACKAGE D

PLASTIC SMALL-OUTLINE

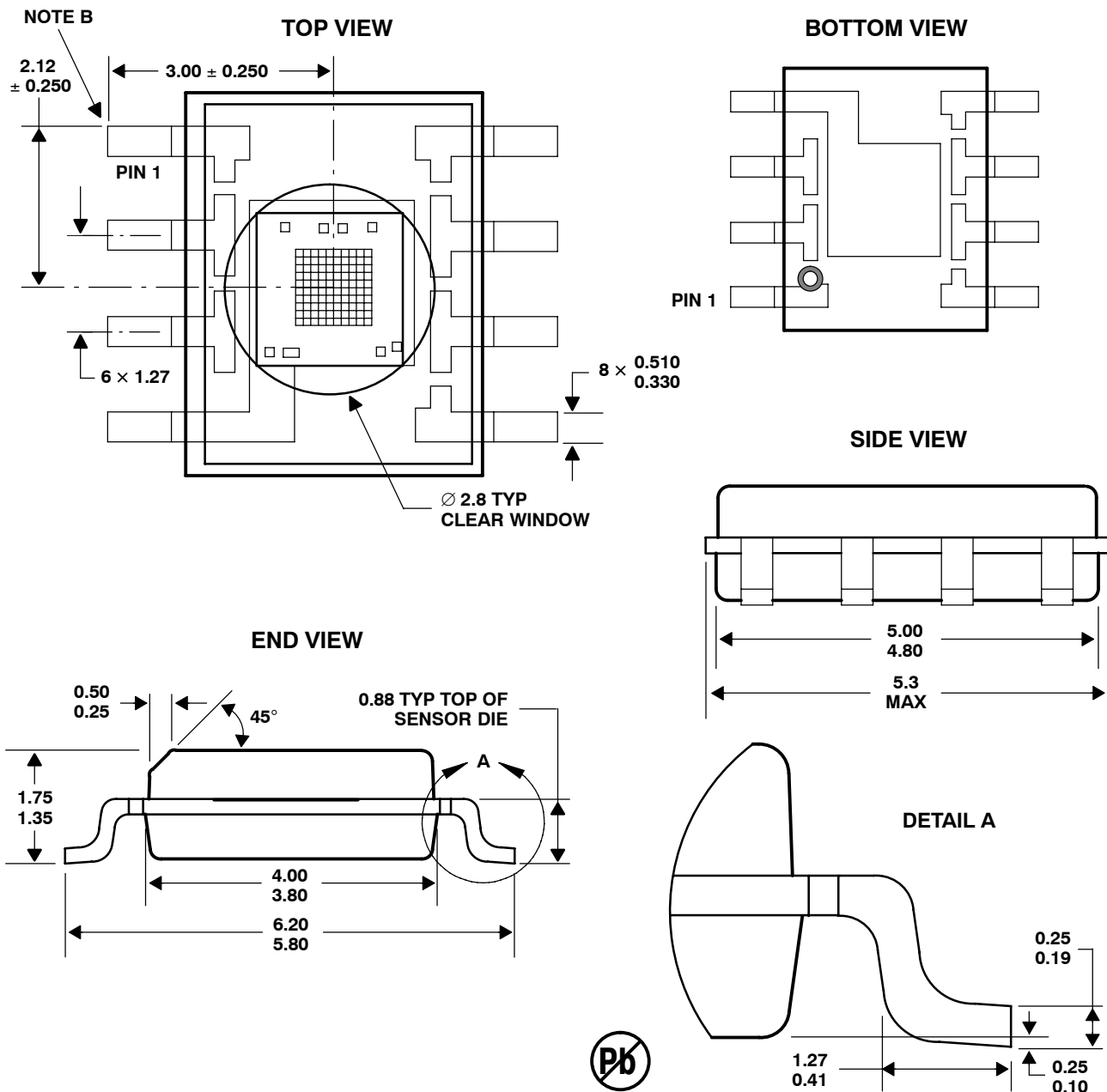

- NOTES: A. All linear dimensions are in millimeters.
 B. The center of the 0.96-mm by 0.96-mm photo-active area is referenced to the upper left corner tip of the lead frame (Pin 1).
 C. Package is molded with an electrically nonconductive clear plastic compound having an index of refraction of 1.55.
 D. This drawing is subject to change without notice.

Figure 8. Package D — Plastic Small Outline IC Packaging Configuration

TSL230RD, TSL230ARD, TSL230BRD PROGRAMMABLE LIGHT-TO-FREQUENCY CONVERTERS

TAOS054P – OCTOBER 2007

MECHANICAL DATA

SIDE VIEW

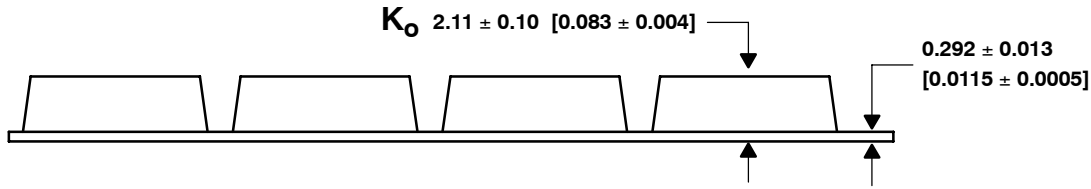

TOP VIEW

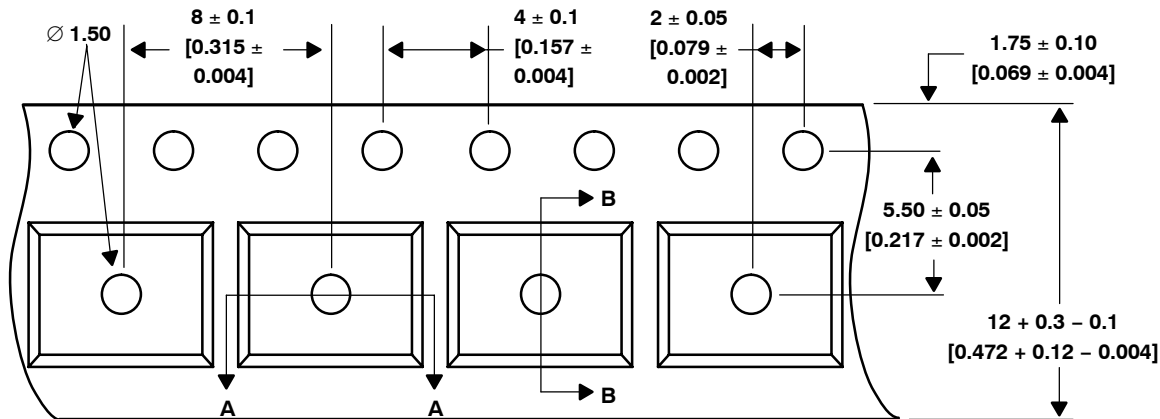

END VIEW



DETAIL A

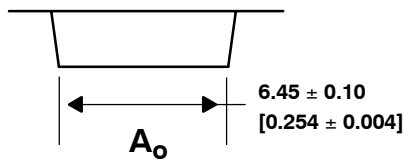

DETAIL B

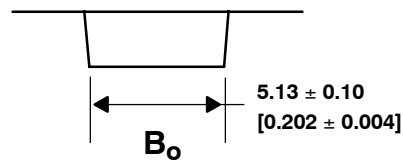

- NOTES: A. All linear dimensions are in millimeters [inches].
 B. The dimensions on this drawing are for illustrative purposes only. Dimensions of an actual carrier may vary slightly.
 C. Symbols on drawing A_o , B_o , and K_o are defined in ANSI EIA Standard 481-B 2001.
 D. Each reel is 178 millimeters in diameter and contains 1000 parts.
 E. TAOS packaging tape and reel conform to the requirements of EIA Standard 481-B.
 F. This drawing is subject to change without notice.

Figure 9. Package D Carrier Tape

MANUFACTURING INFORMATION

The Plastic Small Outline IC package (D) has been tested and has demonstrated an ability to be reflow soldered to a PCB substrate.

The solder reflow profile describes the expected maximum heat exposure of components during the solder reflow process of product on a PCB. Temperature is measured on top of component. The component should be limited to a maximum of three passes through this solder reflow profile.

Table 1. TSL230RD Solder Reflow Profile

PARAMETER	REFERENCE	TSL230RD
Average temperature gradient in preheating		2.5°C/sec
Soak time	t_{soak}	2 to 3 minutes
Time above 217°C	t_1	Max 60 sec
Time above 230°C	t_2	Max 50 sec
Time above $T_{peak} - 10^\circ\text{C}$	t_3	Max 10 sec
Peak temperature in reflow	T_{peak}	260° C (-0°C/+5°C)
Temperature gradient in cooling		Max -5°C/sec

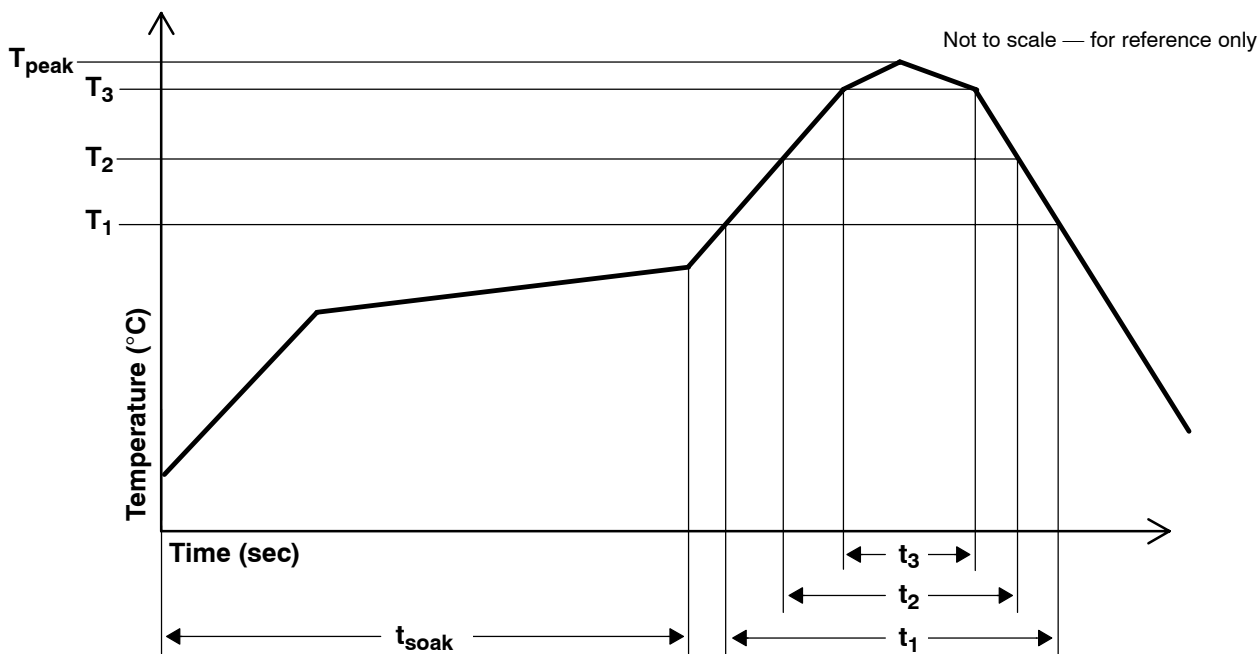

Figure 10. TSL230RD Solder Reflow Profile Graph

TSL230RD, TSL230ARD, TSL230BRD PROGRAMMABLE LIGHT-TO-FREQUENCY CONVERTERS

TAOS054P – OCTOBER 2007

Moisture Sensitivity

Optical characteristics of the device can be adversely affected during the soldering process by the release and vaporization of moisture that has been previously absorbed into the package molding compound. To prevent these adverse conditions, all devices shipped in carrier tape have been pre-baked and shipped in a sealed moisture-barrier bag. No further action is necessary if these devices are processed through solder reflow within 24 hours of the seal being broken on the moisture-barrier bag.

However, for all devices shipped in tubes or if the seal on the moisture barrier bag has been broken for 24 hours or longer, it is recommended that the following procedures be used to ensure the package molding compound contains the smallest amount of absorbed moisture possible.

For devices shipped in tubes:

1. Remove devices from tubes
2. Bake devices for 4 hours, at 90°C
3. After cooling, load devices back into tubes
4. Perform solder reflow within 24 hours after bake

Bake only a quantity of devices that can be processed through solder reflow in 24 hours. Devices can be re-baked for 4 hours, at 90°C for a cumulative total of 12 hours (3 bakes for 4 hours at 90°C).

For devices shipped in carrier tape:

1. Bake devices for 4 hours, at 90°C in the tape
2. Perform solder reflow within 24 hours after bake

Bake only a quantity of devices that can be processed through solder reflow in 24 hours. Devices can be re-baked for 4 hours in tape, at 90°C for a cumulative total of 12 hours (3 bakes for 4 hours at 90°C).

PRODUCTION DATA — information in this document is current at publication date. Products conform to specifications in accordance with the terms of Texas Advanced Optoelectronic Solutions, Inc. standard warranty. Production processing does not necessarily include testing of all parameters.

LEAD-FREE (Pb-FREE) and GREEN STATEMENT

Pb-Free (RoHS) TAOS' terms *Lead-Free* or *Pb-Free* mean semiconductor products that are compatible with the current RoHS requirements for all 6 substances, including the requirement that lead not exceed 0.1% by weight in homogeneous materials. Where designed to be soldered at high temperatures, TAOS Pb-Free products are suitable for use in specified lead-free processes.

Green (RoHS & no Sb/Br) TAOS defines *Green* to mean Pb-Free (RoHS compatible), and free of Bromine (Br) and Antimony (Sb) based flame retardants (Br or Sb do not exceed 0.1% by weight in homogeneous material).

Important Information and Disclaimer The information provided in this statement represents TAOS' knowledge and belief as of the date that it is provided. TAOS bases its knowledge and belief on information provided by third parties, and makes no representation or warranty as to the accuracy of such information. Efforts are underway to better integrate information from third parties. TAOS has taken and continues to take reasonable steps to provide representative and accurate information but may not have conducted destructive testing or chemical analysis on incoming materials and chemicals. TAOS and TAOS suppliers consider certain information to be proprietary, and thus CAS numbers and other limited information may not be available for release.

NOTICE

Texas Advanced Optoelectronic Solutions, Inc. (TAOS) reserves the right to make changes to the products contained in this document to improve performance or for any other purpose, or to discontinue them without notice. Customers are advised to contact TAOS to obtain the latest product information before placing orders or designing TAOS products into systems.

TAOS assumes no responsibility for the use of any products or circuits described in this document or customer product design, conveys no license, either expressed or implied, under any patent or other right, and makes no representation that the circuits are free of patent infringement. TAOS further makes no claim as to the suitability of its products for any particular purpose, nor does TAOS assume any liability arising out of the use of any product or circuit, and specifically disclaims any and all liability, including without limitation consequential or incidental damages.

TEXAS ADVANCED OPTOELECTRONIC SOLUTIONS, INC. PRODUCTS ARE NOT DESIGNED OR INTENDED FOR USE IN CRITICAL APPLICATIONS IN WHICH THE FAILURE OR MALFUNCTION OF THE TAOS PRODUCT MAY RESULT IN PERSONAL INJURY OR DEATH. USE OF TAOS PRODUCTS IN LIFE SUPPORT SYSTEMS IS EXPRESSLY UNAUTHORIZED AND ANY SUCH USE BY A CUSTOMER IS COMPLETELY AT THE CUSTOMER'S RISK.

LUMENOLOGY, TAOS, the TAOS logo, and Texas Advanced Optoelectronic Solutions are registered trademarks of Texas Advanced Optoelectronic Solutions Incorporated.

TSL230RD, TSL230ARD, TSL230BRD PROGRAMMABLE LIGHT-TO-FREQUENCY CONVERTERS

TAOS054P – OCTOBER 2007

Looking for pricing, stock, or lifecycle information?

Click below to explore more details on WIN SOURCE:

 [View TSL230RD-TR on WIN SOURCE](#)

 [ams Information](#)

Optimize Your Supply Chain with WIN SOURCE Solutions

-  Global Sourcing Solution
-  Obsolete Management
-  Cost Control Management
-  Shortage Management
-  Alternative Solution
-  Excess Inventory Management