

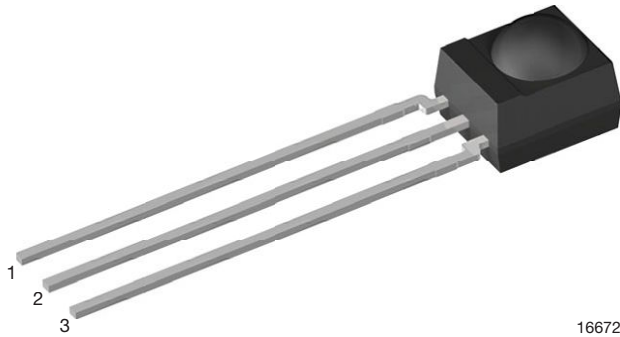

**THE DATASHEET OF
TSOP2136SA1**



IR Receiver Modules for Remote Control Systems



DESIGN SUPPORT TOOLS

[click logo to get started](#)



MECHANICAL DATA

Pinning for TSOP41..., TSOP43..., TSOP45..:

1 = OUT, 2 = GND, 3 = V_S

Pinning for TSOP21..., TSOP23..., TSOP25..:

1 = OUT, 2 = V_S , 3 = GND

FEATURES

- Improved immunity against HF and RF noise
- Low supply current
- Photo detector and preamplifier in one package
- Internal filter for PCM frequency
- Improved shielding against EMI
- Supply voltage: 2.5 V to 5.5 V
- Improved immunity against ambient light
- Insensitive to supply voltage ripple and noise
- Material categorization: for definitions of compliance please see www.vishay.com/doc?99912



DESCRIPTION

These products are miniaturized receivers for infrared remote control systems. A PIN diode and a preamplifier are assembled on a lead frame, the epoxy package contains an IR filter. The demodulated output signal can be directly connected to a microprocessor for decoding.

The TSOP23..., TSOP43.. series devices are optimized to suppress almost all spurious pulses from Wi-Fi and CFL sources. They may suppress some data signals if continuously transmitted.

The TSOP21..., TSOP41.. series devices are provided primarily for compatibility with old AGC1 designs. New designs should prefer the TSOP23..., TSOP43.. series containing the newer AGC3. The TSOP25..., TSOP45.. series are useful to suppress even extreme levels of optical noise, but may also suppress some data signals. Please check compatibility with your codes.

These components have not been qualified according to automotive specifications.

PARTS TABLE							
AGC	LEGACY, FOR SHORT BURST REMOTE CONTROLS (AGC1)		NOISY ENVIRONMENTS AND SHORT BURSTS (AGC3)		VERY NOISY ENVIRONMENTS AND SHORT BURSTS (AGC5)		
Carrier frequency	30 kHz	TSOP4130	TSOP2130	TSOP4330	TSOP2330	TSOP4530	TSOP2530
	33 kHz	TSOP4133	TSOP2133	TSOP4333	TSOP2333	TSOP4533	TSOP2533
	36 kHz	TSOP4136	TSOP2136	TSOP4336 ⁽¹⁾	TSOP2336 ⁽¹⁾	TSOP4536	TSOP2536 ⁽¹⁾
	38 kHz	TSOP4138	TSOP2138	TSOP4338 ⁽²⁾⁽³⁾⁽⁴⁾⁽⁵⁾	TSOP2338 ⁽²⁾⁽³⁾⁽⁴⁾⁽⁵⁾	TSOP4538	TSOP2538 ⁽²⁾⁽³⁾⁽⁴⁾
	40 kHz	TSOP4140	TSOP2140	TSOP4340	TSOP2340	TSOP4540	TSOP2540
	56 kHz	TSOP4156	TSOP2156	TSOP4356	TSOP2356	TSOP4556	TSOP2556
Package	Mold						
Pinning	1 = OUT, 2 = GND, 3 = V_S	1 = OUT, 2 = V_S , 3 = GND	1 = OUT, 2 = GND, 3 = V_S	1 = OUT, 2 = V_S , 3 = GND	1 = OUT, 2 = GND, 3 = V_S	1 = OUT, 2 = GND, 3 = V_S	1 = OUT, 2 = V_S , 3 = GND
Dimensions (mm)	6.0 W x 6.95 H x 5.6 D						
Mounting	Leaded						
Application	Remote control						
Best choice for	⁽¹⁾ MCIR ⁽²⁾ Mitsubishi ⁽³⁾ RECS-80 Code ⁽⁴⁾ r-map ⁽⁵⁾ XMP-1, XMP-2						

BLOCK DIAGRAM

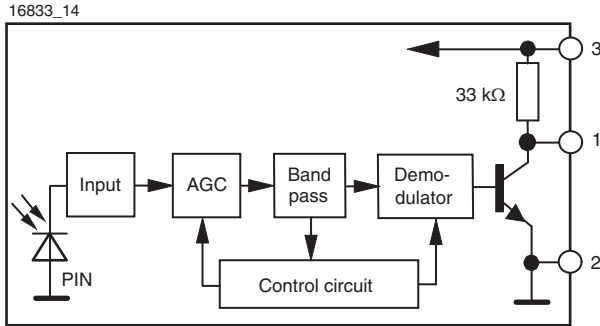

APPLICATION CIRCUIT



ABSOLUTE MAXIMUM RATINGS

PARAMETER	TEST CONDITION	SYMBOL	VALUE	UNIT
Supply voltage		V_S	-0.3 to +6	V
Supply current		I_S	5	mA
Output voltage		V_O	-0.3 to 5.5	V
Voltage at output to supply		$V_S - V_O$	-0.3 to $(V_S + 0.3)$	V
Output current		I_O	5	mA
Junction temperature		T_j	100	°C
Storage temperature range		T_{stg}	-25 to +85	°C
Operating temperature range		T_{amb}	-25 to +85	°C
Power consumption	$T_{amb} \leq 85\text{ °C}$	P_{tot}	10	mW
Soldering temperature	$t \leq 10\text{ s}$, 1 mm from case	T_{sd}	260	°C

Note

- Stresses beyond those listed under “Absolute Maximum Ratings” may cause permanent damage to the device. This is a stress rating only and functional operation of the device at these or any other conditions beyond those indicated in the operational sections of this specification is not implied. Exposure to absolute maximum rating conditions for extended periods may affect the device reliability

ELECTRICAL AND OPTICAL CHARACTERISTICS ($T_{amb} = 25\text{ °C}$, unless otherwise specified)

PARAMETER	TEST CONDITION	SYMBOL	MIN.	TYP.	MAX.	UNIT
Supply current	$E_v = 0$, $V_S = 5\text{ V}$	I_{SD}	0.55	0.7	0.9	mA
	$E_v = 40\text{ klx}$, sunlight	I_{SH}	-	0.8	-	mA
Supply voltage		V_S	2.5	-	5.5	V
Transmission distance	$E_v = 0$, test signal see Fig. 1, IR diode TSAL6200, $I_F = 50\text{ mA}$	d	-	24	-	m
Output voltage low	$I_{OSL} = 0.5\text{ mA}$, $E_e = 0.7\text{ mW/m}^2$, test signal see Fig. 1	V_{OSL}	-	-	100	mV
Minimum irradiance	Pulse width tolerance: $t_{pi} - 5/f_o < t_{po} < t_{pi} + 6/f_o$, test signal see Fig. 1	$E_e\text{ min.}$	-	0.12	0.25	mW/m ²
Maximum irradiance	$t_{pi} - 5/f_o < t_{po} < t_{pi} + 6/f_o$, test signal see Fig. 1	$E_e\text{ max.}$	50	-	-	W/m ²
Directivity	Angle of half transmission distance	$\phi_{1/2}$	-	± 45	-	deg

TYPICAL CHARACTERISTICS ($T_{amb} = 25\text{ }^{\circ}\text{C}$, unless otherwise specified)

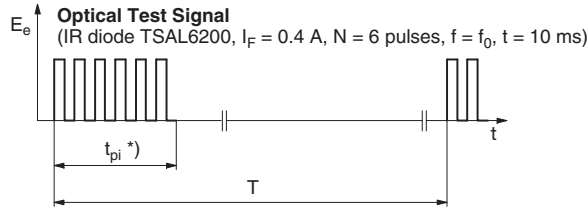

*) $t_{pi} \geq 6/f_0$ is recommended for optimal function

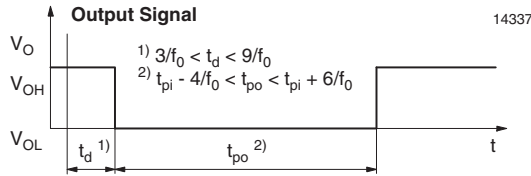

Fig. 1 - Output Active Low

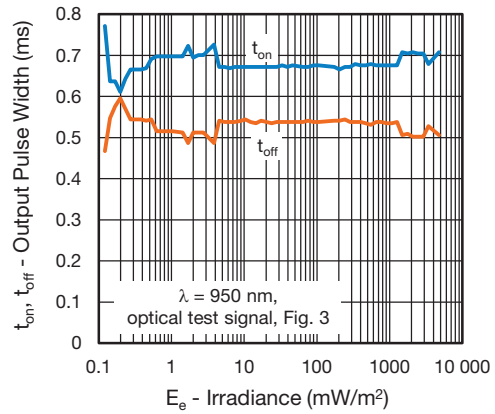

Fig. 4 - Output Pulse Diagram

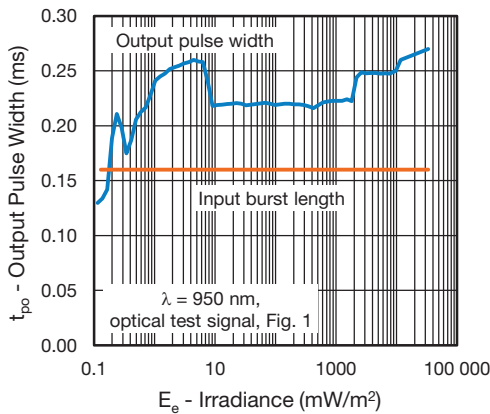

Fig. 2 - Pulse Length and Sensitivity in Dark Ambient

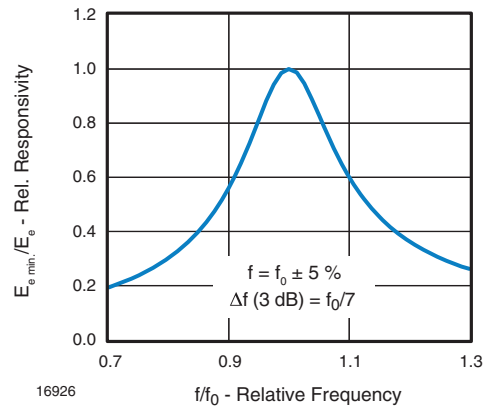

Fig. 5 - Frequency Dependence of Responsivity

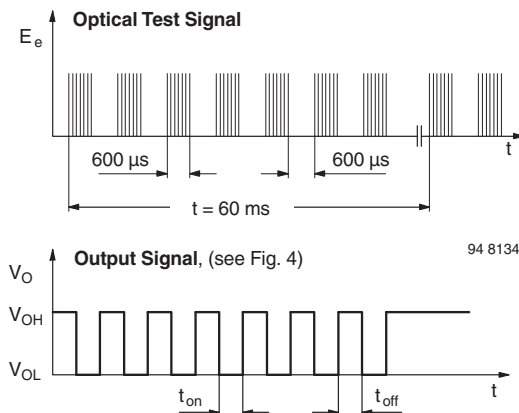

Fig. 3 - Output Function

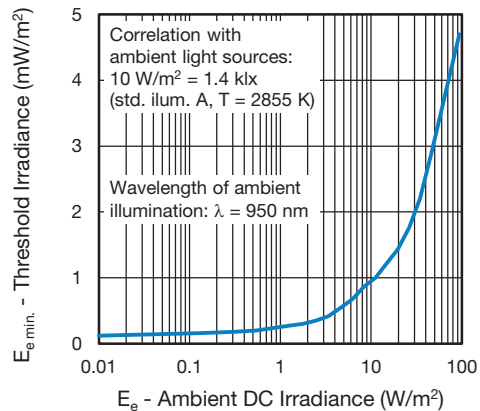

Fig. 6 - Sensitivity in Bright Ambient

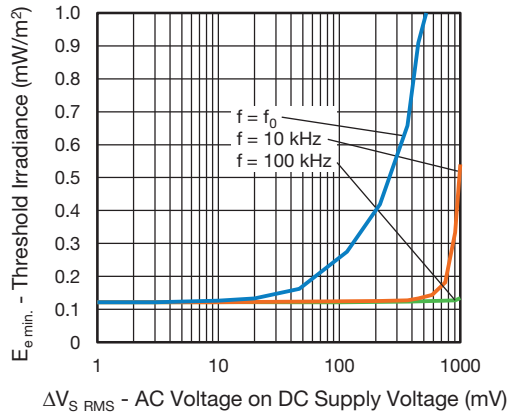

Fig. 7 - Sensitivity vs. Supply Voltage Disturbances

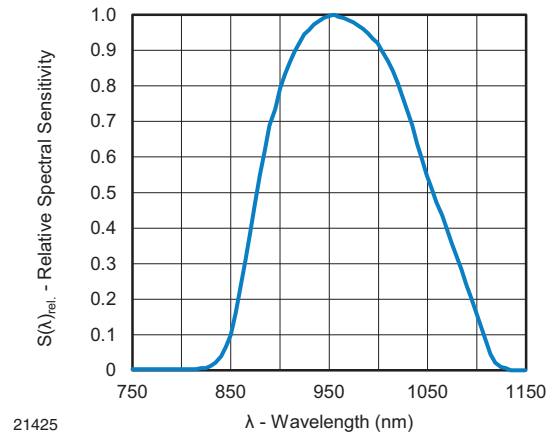

Fig. 10 - Relative Spectral Sensitivity vs. Wavelength

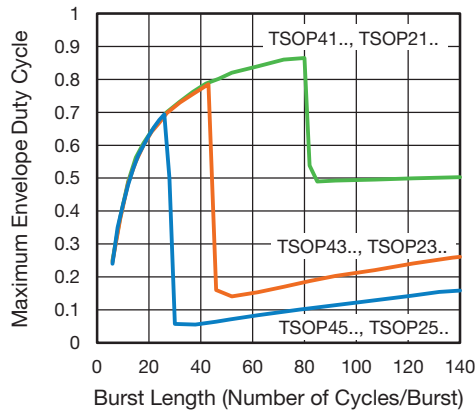

Fig. 8 - Max. Envelope Duty Cycle vs. Burst Length

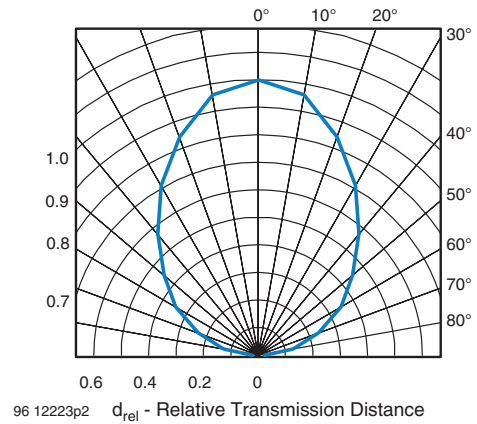

Fig. 11 - Horizontal Directivity

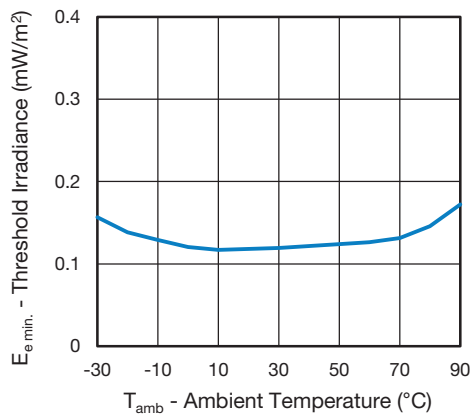

Fig. 9 - Sensitivity vs. Ambient Temperature

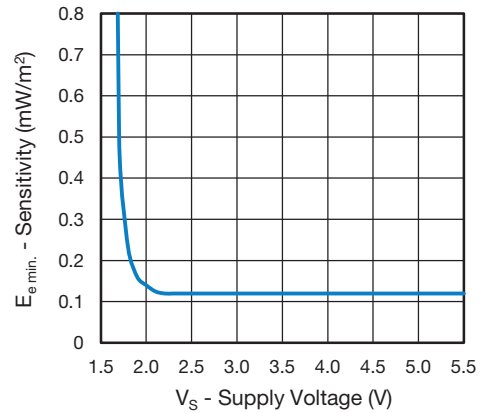

Fig. 12 - Sensitivity vs. Supply Voltage

SUITABLE DATA FORMAT

This series is designed to suppress spurious output pulses due to noise or disturbance signals. The devices can distinguish data signals from noise due to differences in frequency, burst length, and envelope duty cycle. The data signal should be close to the device’s band-pass center frequency (e.g. 38 kHz) and fulfill the conditions in the table below.

When a data signal is applied to the product in the presence of a disturbance, the sensitivity of the receiver is automatically reduced by the AGC to insure that no spurious pulses are present at the receiver’s output. Some examples which are suppressed are:

- DC light (e.g. from tungsten bulbs sunlight)
- Continuous signals at any frequency
- Strongly or weakly modulated patterns from fluorescent lamps with electronic ballasts (see Fig. 13 or Fig. 14).
- 2.4 GHz and 5 GHz Wi-Fi

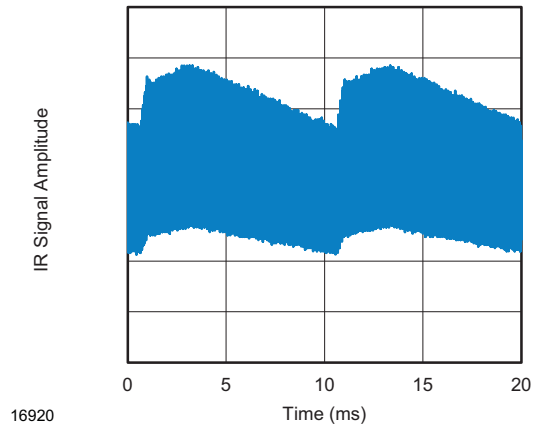

Fig. 13 - IR Disturbance from Fluorescent Lamp With Low Modulation

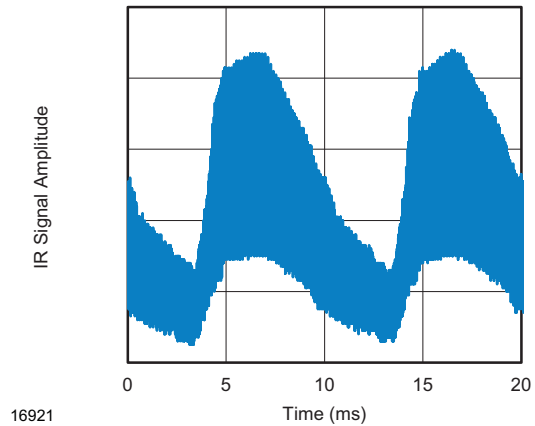

Fig. 14 - IR Disturbance from Fluorescent Lamp With High Modulation

	TSOP41..., TSOP21..	TSOP43..., TSOP23..	TSOP45..., TSOP25..
Minimum burst length	6 cycles/burst	6 cycles/burst	6 cycles/burst
After each burst of length A gap time is required of	6 to 70 cycles ≥ 10 cycles	6 to 35 cycles ≥ 10 cycles	6 to 24 cycles ≥ 10 cycles
For bursts greater than a minimum gap time in the data stream is needed of	70 cycles > 1.2 x burst length	35 cycles > 6 x burst length	24 cycles > 25 ms
Maximum number of continuous short bursts/second	2000	2000	2000
MCIR code	Yes	Preferred	Yes
XMP-1, XMP-2 code	Yes	Preferred	Yes
Suppression of interference from fluorescent lamps	Mild disturbance patterns are suppressed (example: signal pattern of Fig. 13)	Complex disturbance patterns are suppressed (example: signal pattern of Fig. 14)	Critical disturbance patterns are suppressed, e.g. highly dimmed LCDs

Note

- For data formats with long bursts (more than 10 carrier cycles) please see the datasheet for TSOP48..., TSOP44..., TSOP22..., TSOP24..



PACKAGE DIMENSIONS in millimeters

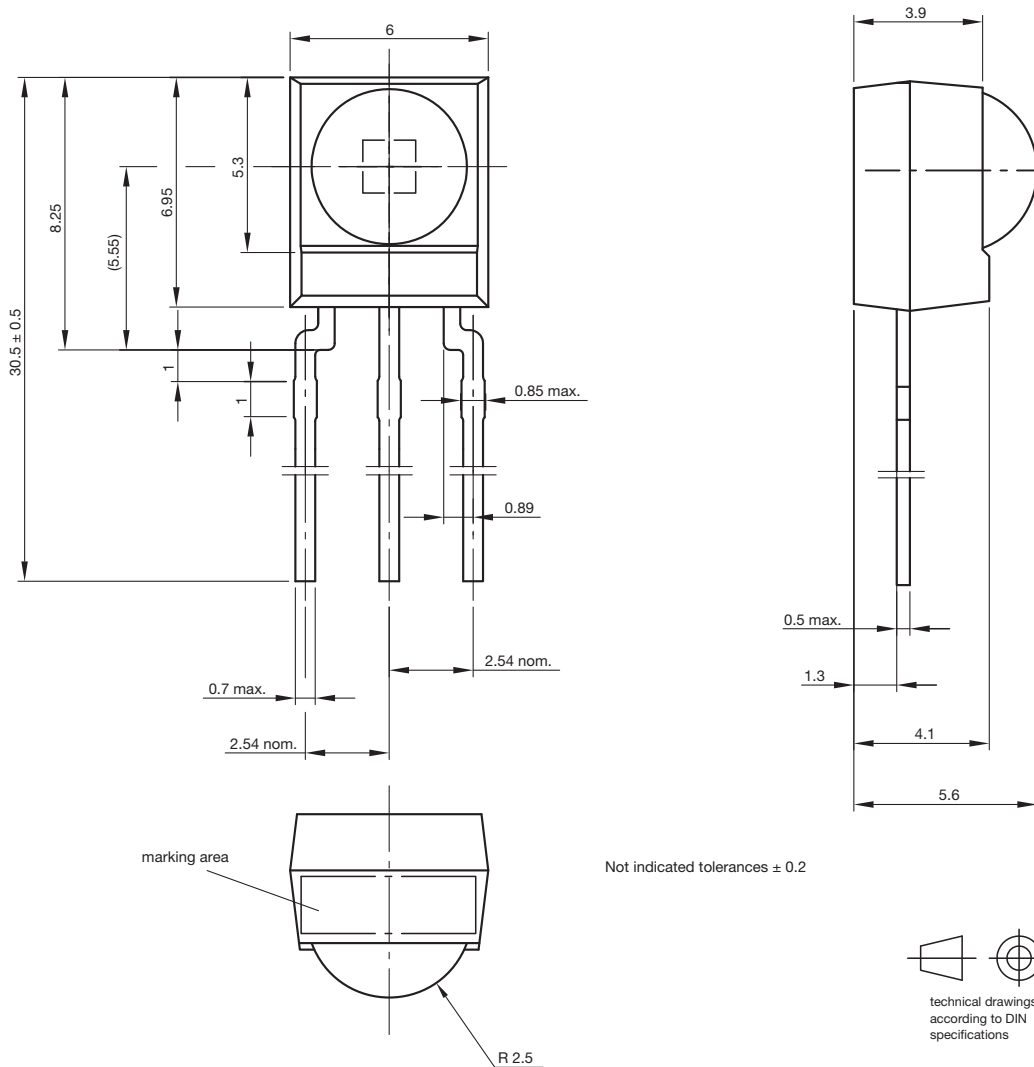

Drawing-No.: 6.550-5169.01-4
Issue: 9; 03.11.10
13655



Disclaimer

ALL PRODUCT, PRODUCT SPECIFICATIONS AND DATA ARE SUBJECT TO CHANGE WITHOUT NOTICE TO IMPROVE RELIABILITY, FUNCTION OR DESIGN OR OTHERWISE.

Vishay Intertechnology, Inc., its affiliates, agents, and employees, and all persons acting on its or their behalf (collectively, "Vishay"), disclaim any and all liability for any errors, inaccuracies or incompleteness contained in any datasheet or in any other disclosure relating to any product.

Vishay makes no warranty, representation or guarantee regarding the suitability of the products for any particular purpose or the continuing production of any product. To the maximum extent permitted by applicable law, Vishay disclaims (i) any and all liability arising out of the application or use of any product, (ii) any and all liability, including without limitation special, consequential or incidental damages, and (iii) any and all implied warranties, including warranties of fitness for particular purpose, non-infringement and merchantability.

Statements regarding the suitability of products for certain types of applications are based on Vishay's knowledge of typical requirements that are often placed on Vishay products in generic applications. Such statements are not binding statements about the suitability of products for a particular application. It is the customer's responsibility to validate that a particular product with the properties described in the product specification is suitable for use in a particular application. Parameters provided in datasheets and / or specifications may vary in different applications and performance may vary over time. All operating parameters, including typical parameters, must be validated for each customer application by the customer's technical experts. Product specifications do not expand or otherwise modify Vishay's terms and conditions of purchase, including but not limited to the warranty expressed therein.

Except as expressly indicated in writing, Vishay products are not designed for use in medical, life-saving, or life-sustaining applications or for any other application in which the failure of the Vishay product could result in personal injury or death. Customers using or selling Vishay products not expressly indicated for use in such applications do so at their own risk. Please contact authorized Vishay personnel to obtain written terms and conditions regarding products designed for such applications.

No license, express or implied, by estoppel or otherwise, to any intellectual property rights is granted by this document or by any conduct of Vishay. Product names and markings noted herein may be trademarks of their respective owners.

Looking for pricing, stock, or lifecycle information?

Click below to explore more details on WIN SOURCE:

 [View TSOP2136SA1 on WIN SOURCE](#)

 [Vishay Information](#)

Optimize Your Supply Chain with WIN SOURCE Solutions

-  Global Sourcing Solution
-  Obsolete Management
-  Cost Control Management
-  Shortage Management
-  Alternative Solution
-  Excess Inventory Management