



**THE DATASHEET OF  
UF1006-T**



### Features

- Diffused Junction
- Ultra-Fast Switching for High Efficiency
- High Current Capability and Low Forward Voltage Drop
- Low Reverse Leakage Current
- Surge Overload Rating to 30A Peak
- Low Reverse Leakage Current
- Plastic Material: UL Flammability Classification Rating 94V-0

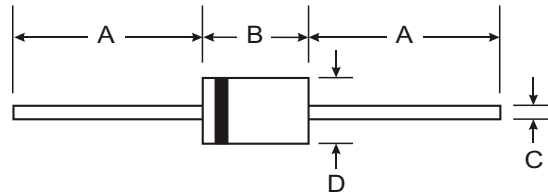

### Mechanical Data

- Case: Molded Plastic
- Terminals: Plated Leads Solderable per MIL-STD-202, Method 208
- Polarity: Cathode Band
- Marking: Type Number
- Weight: 0.35 grams (approx.)
- Mounting Position: Any

DO-41		
Dim	Min	Max
A	25.40	—
B	4.06	5.21
C	0.71	0.864
D	2.00	2.72
All Dimensions in mm		

### Maximum Ratings and Electrical Characteristics @ T<sub>A</sub> = 25°C unless otherwise specified

Single phase, half wave, 60Hz, resistive or inductive load.  
For capacitive load, derate current by 20%.

Characteristic	Symbol	UF 1001	UF 1002	UF 1003	UF 1004	UF 1005	UF 1006	UF 1007	Unit
Peak Repetitive Reverse Voltage	V <sub>RRM</sub>	50	100	200	400	600	800	1000	V
Working Peak Reverse Voltage	V <sub>RWM</sub>								
DC Blocking Voltage	V <sub>R</sub>								
RMS Reverse Voltage	V <sub>R(RMS)</sub>	35	70	140	280	420	560	700	V
Average Rectified Output Current (Note 1) @ T <sub>A</sub> = 55°C	I <sub>O</sub>	1.0							A
Non-Repetitive Peak Forward Surge Current (JEDEC Method) 8.3ms Single half sine-wave Superimposed on Rated Load	I <sub>FSM</sub>	30							A
Forward Voltage @ I <sub>F</sub> = 1.0A	V <sub>FM</sub>	1.0		1.3		1.7		V	
Peak Reverse Current at Rated DC Blocking Voltage @ T <sub>A</sub> = 25°C @ T <sub>A</sub> = 100°C	I <sub>RM</sub>	5.0 100							μA
Reverse Recovery Time (Note 3)	t <sub>rr</sub>	50				75			ns
Typical Junction Capacitance (Note 2)	C <sub>j</sub>	20				10			pF
Typical Thermal Resistance Junction to Ambient	R <sub>θJA</sub>	95							K/W
Operating and Storage Temperature Range	T <sub>j</sub> , T <sub>STG</sub>	-65 to +150							°C

- Notes:
1. Valid provided that leads are maintained at ambient temperature at a distance of 9.5mm from the case.
  2. Measured at 1.0MHz and applied reverse voltage of 4.0V DC.
  3. Measured with I<sub>F</sub> = 0.5A, I<sub>R</sub> = 1.0A, I<sub>rr</sub> = 0.25A. See figure 5.

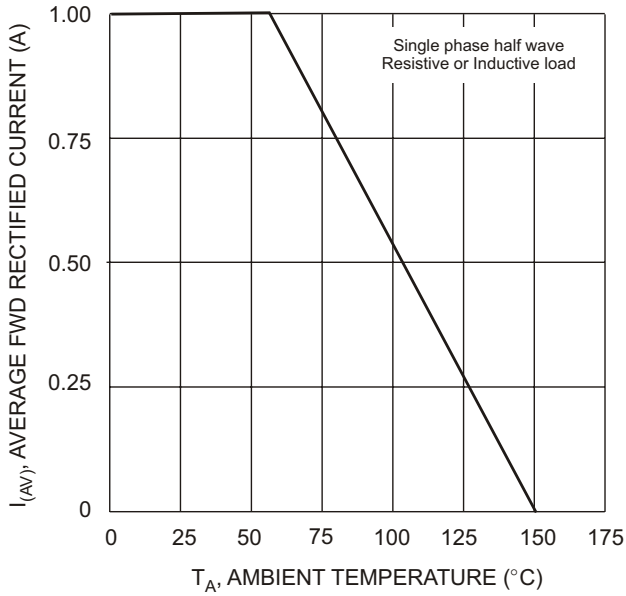

Fig. 1 Forward Current Derating Curve

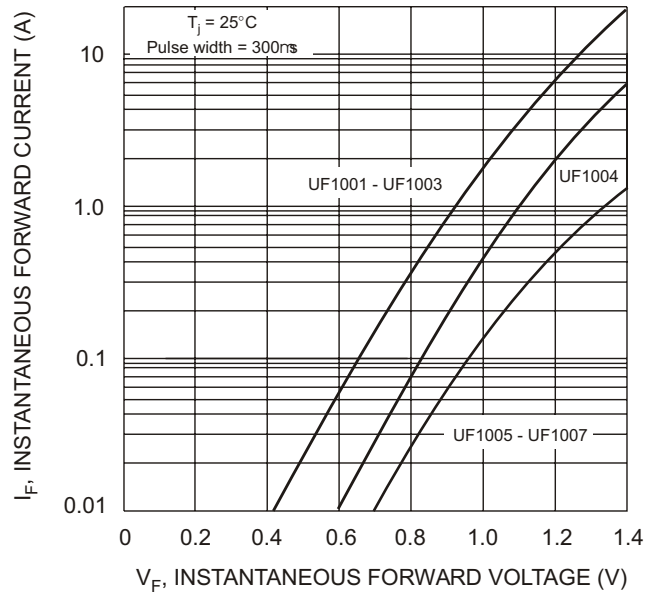

Fig. 2 Typical Forward Characteristics

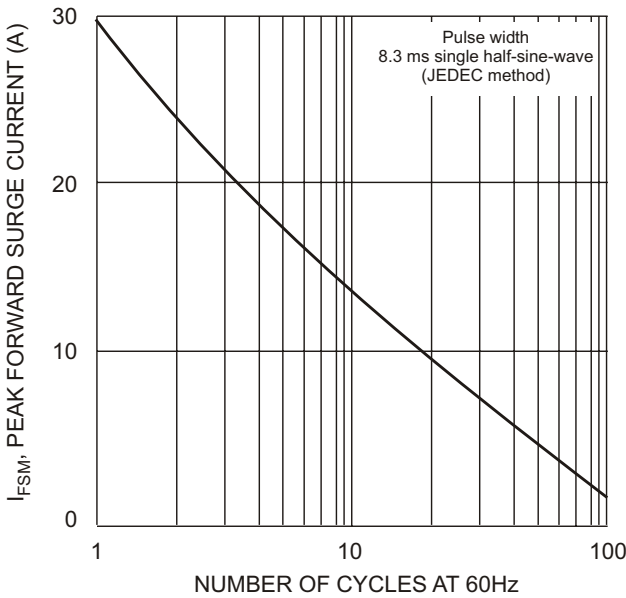

Fig. 3 Peak Forward Surge Current

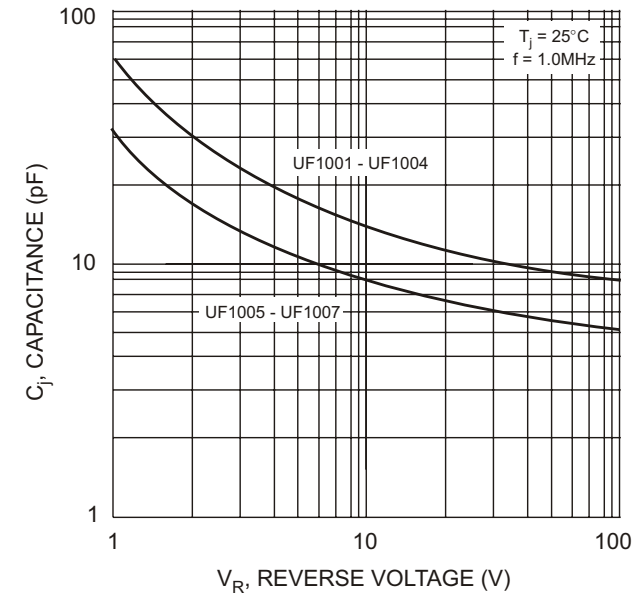
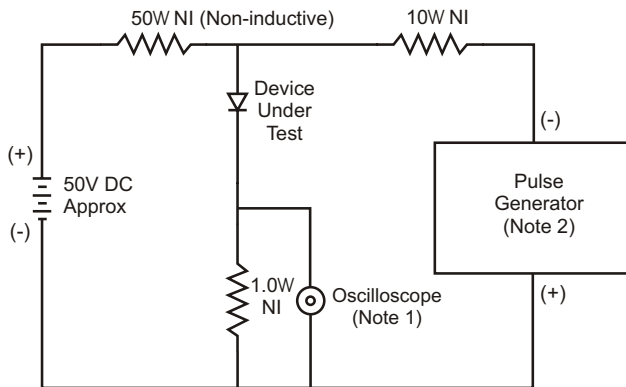
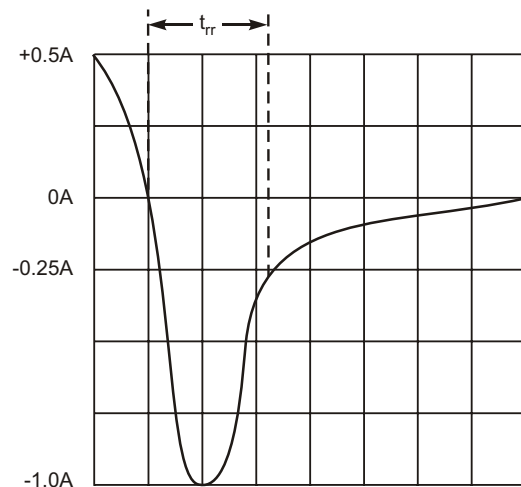

Fig. 4 Typical Junction Capacitance



- Notes:  
 1. Rise Time = 7.0ns max. Input Impedance = 1.0MW, 22pF.  
 2. Rise Time = 10ns max. Input Impedance = 50W.





Set time base for 50/100 ns/cm

Fig. 5 Reverse Recovery Time Characteristic and Test Circuit

## Looking for pricing, stock, or lifecycle information?

Click below to explore more details on WIN SOURCE:

-  [View UF1006-T on WIN SOURCE](#)
-  [Diodes Incorporated Information](#)

## Optimize Your Supply Chain with WIN SOURCE Solutions

-  Global Sourcing Solution
-  Obsolete Management
-  Cost Control Management
-  Shortage Management
-  Alternative Solution
-  Excess Inventory Management