



Powermite 3 Surface Mount 8 Amp 40 Volt Schottky Rectifier

DESCRIPTION

The UPS840e3 offers an exceptionally small and powerful RoHS compliant package for a 40 V, 8 Amp Schottky rectifier. Competing solutions typically come only in much larger packages. It is an ideal, small footprint, surface mount solution with a full metallic bottom side and is compatible with automatic insertion equipment. In combination with Microsemi's unique internal locking tab on the die, it provides a very low thermal resistance path to move heat out of the package. The resulting lowering of junction temperature in the die provides for lower leakage current and power loss.

Important: For the latest information, visit our website <http://www.microsemi.com>.

FEATURES

- Low profile package (<1.1 mm)
- Small footprint: 32 mm² (4.826 x 6.604 mm) or 0.05 in² (0.190 x 0.260 inches). See mounting pad details on the [last page](#).
- Plastic package has Underwriters Laboratory Flammability classification 94V-0
- RoHS compliant

APPLICATIONS / BENEFITS

- High current capability with low forward voltage drop
- Guard ring construction for transient protection
- Silicon Schottky (hot carrier) rectifier for minimal t_{rr} and minimal reverse recovery voltage
- Elimination of reverse-recovery oscillations to reduce need for EMI filtering.
- For use in high-frequency switching power supplies, inverters, free-wheeling diode applications, charge pump circuits, and polarity protection applications.
- Low forward power loss and high efficiency
- Low inductive parasitics (<2nH) for minimal L (di/dt) effects
- Robust package configuration for pick-and-place handling
- Full-metallic bottom eliminates flux entrapment

MAXIMUM RATINGS

Parameters/Test Conditions	Symbol	Value	Unit
Storage Temperature	T _{STG}	-55 to +150	°C
Junction Temperature	T _J	-55 to +125	°C
Thermal Resistance Junction-to-Ambient ⁽¹⁾	R _{θJA}	65	°C/W
Thermal Resistance Junction-to-Case	R _{θJC}	2.5	°C/W
Forward Surge Current ⁽²⁾	I _{FSM}	150	A
Total Capacitance @ 1 MHz and V _R of 4.0 V	C _T	700	pF
Average Rectified Output Current @ T _C = 75 °C	I _O	8.0	A
Solder Temperature @ 10 s		260	°C

Notes: 1. On PCB with FR4 using 2 oz copper and recommended mounting pad size (see [pad layout](#)).
2. At 8.3 ms single half-sine waveform superimposed on rated load (JEDEC method).

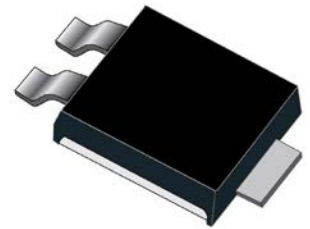

**Powermite 3
Package**

MSC – Lawrence
6 Lake Street,
Lawrence, MA 01841
Tel: 1-800-446-1158 or
(978) 620-2600
Fax: (978) 689-0803

MSC – Ireland
Gort Road Business Park,
Ennis, Co. Clare, Ireland
Tel: +353 (0) 65 6840044
Fax: +353 (0) 65 6822298

Website:
www.microsemi.com

MECHANICAL and PACKAGING

- CASE: Molded epoxy package meets UL94V-0
- TERMINALS: Copper with annealed matte-tin plating for RoHS compliance. Solderable per MIL-STD-750 method 2026. (Consult factory for tin-lead plating).
- MARKING: Body marked with "S840•" (dot indicates RoHS compliance)
- POLARITY: Two-leads on side are internally connected together for anode and bottom side is the cathode.
- TAPE & REEL option: Packaging per EIA-481-2 with 16 mm tape. Consult factory for quantities.
- WEIGHT: Approximately 0.072 grams
- See [Package Dimensions](#) on last page.

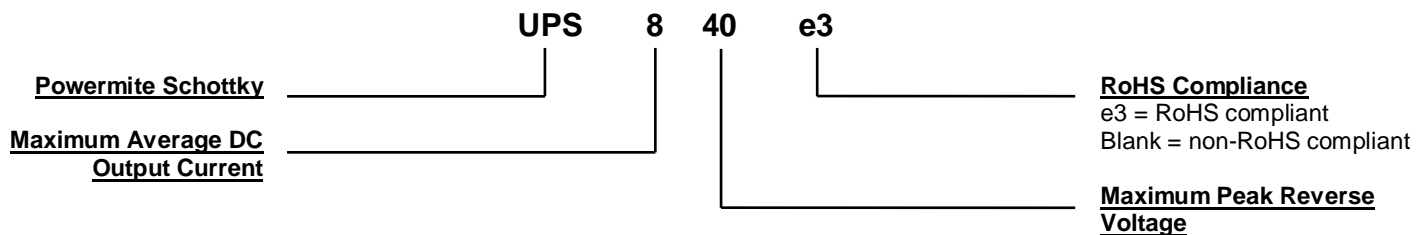
PART NOMENCLATURE

SYMBOLS & DEFINITIONS

Symbol	Definition
C_T	Total Capacitance: The total small signal capacitance between the diode terminals of a complete device.
I_F	Forward Current: The forward current dc value, no alternating component.
I_{FSM}	Maximum Forward Surge Current: The forward current, surge peak or rated forward surge current.
I_O	Average Rectified Output Current: The output current averaged over a full cycle with a 50 Hz or 60 Hz sine-wave input and a 180 degree conduction angle.
I_R	Reverse Current: The maximum reverse (leakage) current that will flow at the specified voltage and temperature.
V_F	Maximum Forward Voltage: The maximum forward voltage the device will exhibit at a specified current.
V_R	Reverse Voltage: The reverse voltage dc value, no alternating component.
V_{RRM}	Repetitive Peak Reverse Voltage: The peak reverse voltage including all repetitive transient voltages but excluding all non-repetitive transient voltages.
V_{RWM}	Working Peak Reverse Voltage: The maximum peak voltage that can be applied over the operating temperature range excluding all transient voltages (ref JESD282-B). Also sometimes known as PIV.

ELECTRICAL CHARACTERISTICS

Part Number	Working Peak Reverse Voltage V_{RWM}	Maximum RMS Voltage V_{RMS}	Maximum Peak Repetitive Voltage V_{RRM}	Maximum Forward Voltage (Note 1)			Maximum Reverse Current I_R @ V_{RWM}	Maximum Voltage Rate of Change dV/dt
				V_F @ 3 A	V_F @ 8 A	V_F @ 10 A		
	Volts	Volts	Volts	Volts	Volts	Volts	mA	V/ μ s
UPS840e3	40	28	40	0.39	0.45	0.49	0.5	1000

NOTES: (1) Pulse test, 1% duty cycle.

GRAPHS

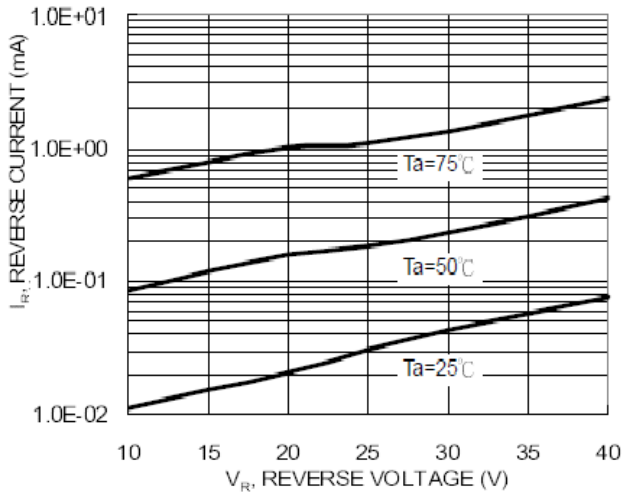

Fig 1. Typical Reverse Characteristics

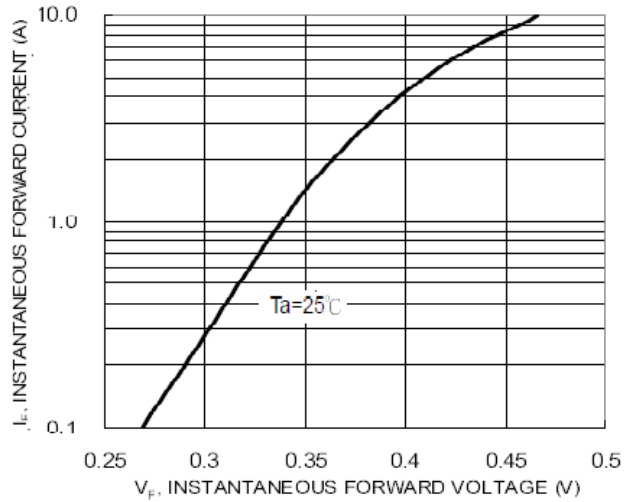
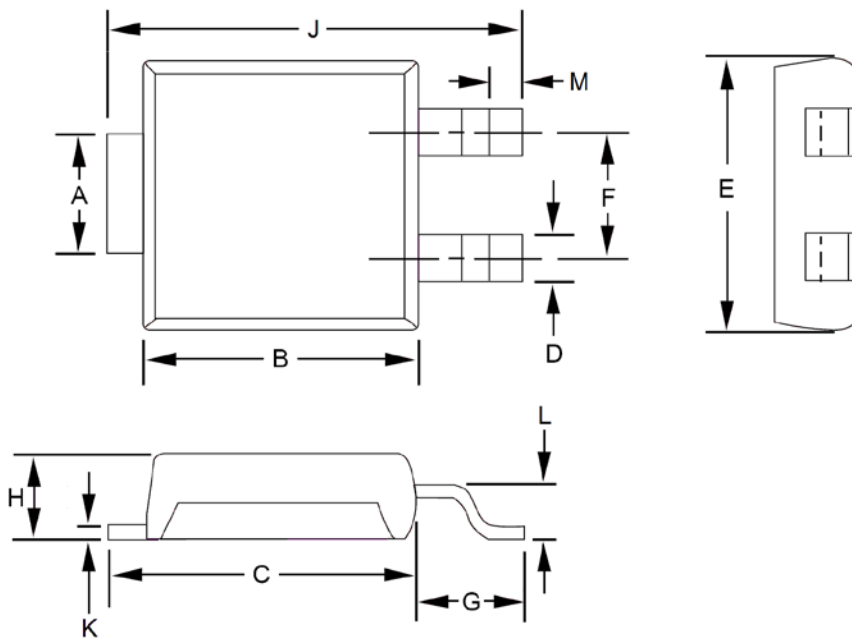
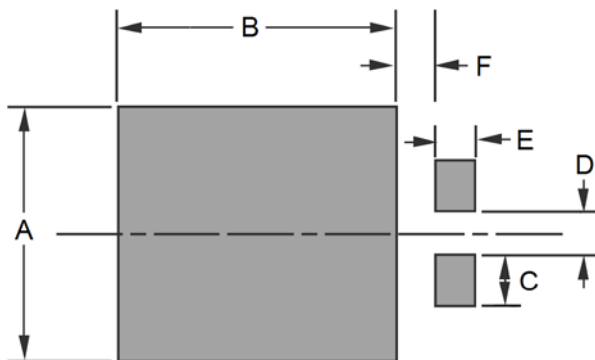

Fig 2. Typical Reverse Characteristics

PACKAGE DIMENSIONS

DIM	INCH		MILLIMETERS	
	MIN	MAX	MIN	MAX
A	0.068	0.072	1.73	1.83
B	0.172	0.174	4.37	4.43
C	0.197	0.204	5.01	5.17
D	0.035 NOM		0.889 NOM	
E	0.159	0.161	4.03	4.09
F	0.072 NOM		1.83 NOM	
G	0.056 NOM		1.422 NOM	
H	0.043	0.045	1.10	1.14
J	0.252	0.260	6.40	6.61
K	0.007 NOM		0.178 NOM	
L	0.028	0.030	0.71	0.77
M	0.014	0.018	0.36	0.46

PAD LAYOUT

DIM	INCH	MILLIMETERS
	NOMINAL	NOMINAL
A	0.190	4.826
B	0.210	5.344
C	0.038	0.965
D	0.034	0.864
E	0.030	0.762
F	0.030	0.762

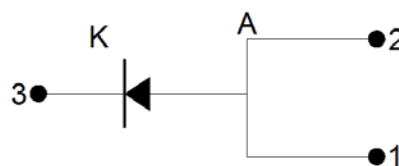
SCHEMATIC

Looking for pricing, stock, or lifecycle information?

Click below to explore more details on WIN SOURCE:

-  [View UPS840E3/TR13 on WIN SOURCE](#)
-  [Microsemi Corporation](#) Information

Optimize Your Supply Chain with WIN SOURCE Solutions

-  Global Sourcing Solution
-  Obsolete Management
-  Cost Control Management
-  Shortage Management
-  Alternative Solution
-  Excess Inventory Management