



**THE DATASHEET OF  
A8737EEJTR-T**





[Home](#) / [Products](#) / [Part Numbers](#) / A8737 and A8738

## A8737 and A8738 Xenon Photoflash Drivers with Fixed IGBT Gate Driver

### Data sheet

- [Contact Allegro Marketing](#)

### Features

- Primary side sense technology
- Fixed IGBT Drive Voltage (3 V or 5 V)
- 3 × 3 10 pin TDFN package

### Applications

- Cell phone camera modules

### Description

The Allegro® A8737 and A8738 Xenon photoflash charger ICs are designed to meet the needs of ultra-low power, small form factor cameras, particularly camera-phones.

These devices integrate a fixed regulator to precisely control the IGBT flash current over a wide range of battery voltages. The A8737 provides regulated 5 V, and the A8738 provides 3 V, gate drive. The IGBT driver also has separate source and sink connections, for flexibility in controlling IGBT rise and fall times.

The charge current time is adjustable by setting the charge current limit from 0.4 to 0.9 A maximum. By using primary side voltage sensing, the need for a secondary-side resistive voltage divider is eliminated. This has the additional benefit of reducing leakage currents on the secondary side of the transformer. To extend battery life, the A8737 and A8738 feature very low supply current draw-typically 0.5  $\mu$ A maximum in shutdown mode.

The charge and trigger voltage logic thresholds are set at 1.1 VHI(min) to support applications implementing low voltage control logic.

The devices are available in a 10-contact, 3 mm × 3 mm MLP/TDFN package with exposed pad for enhanced thermal performance. It is lead (Pb) free, with 100% matte-tin leadframe plating. For an even smaller PCB footprint, a wafer-level chip scale package (WLCSF) option is available (contact factory for availability).

### Functional Block Diagram



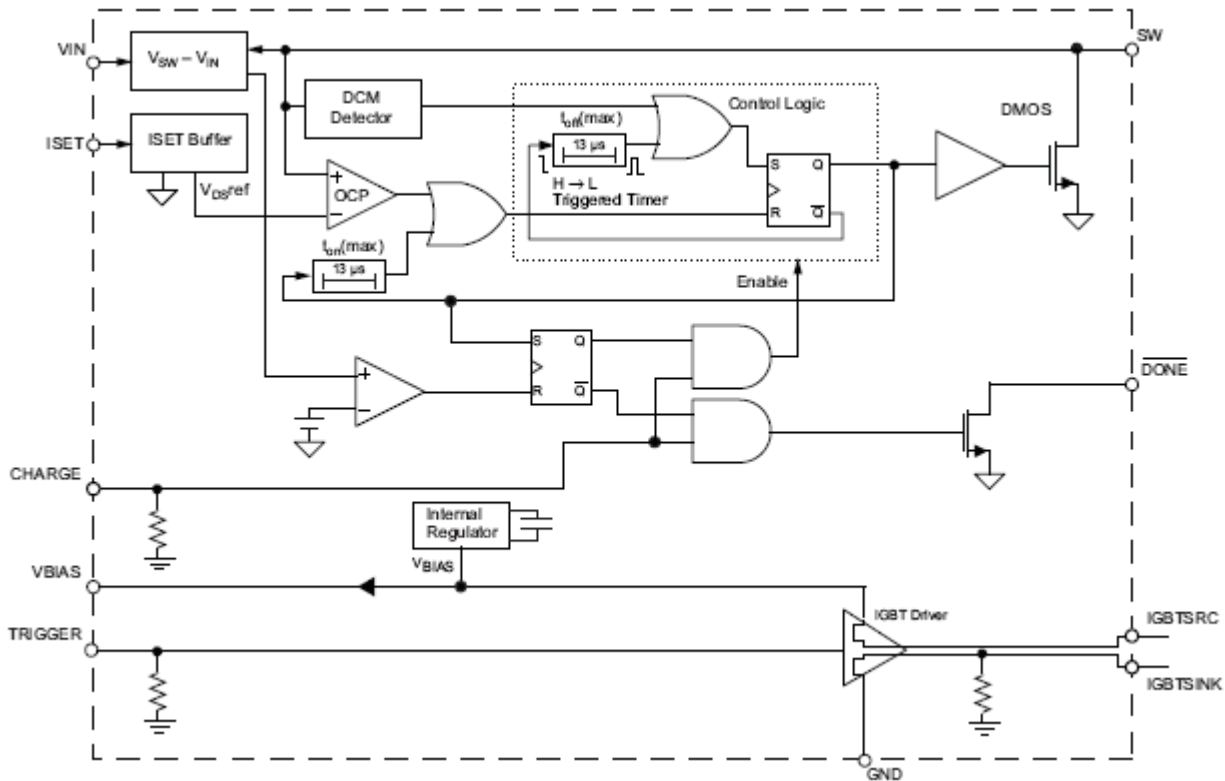

### Complete Part Numbers

Part Number	Package Type	RoHS Compliant	Part Composition/ RoHS Data	Temperature	Comments	Samples	Distributor Stock
A8737EEJTR-T	10-lead MLP	Yes	<a href="#">view data</a>	-40 °C to 85 °C	<i>new</i>	<a href="#">Contact Local Sales Representative</a> or check distributor stock	<input type="button" value="Check Stock"/>
A8738EEJTR-T	10-lead MLP	Yes	<a href="#">view data</a>	-40 °C to 85 °C	<i>new</i>	<a href="#">Contact Local Sales Representative</a> or check distributor stock	<input type="button" value="Check Stock"/>

*Allegro's products are not to be used in life support devices or systems, if a failure of an Allegro product can reasonably be expected to cause the failure of that life support device or system, or to affect the safety or effectiveness of that device or system.*

Copyright © 2009 Allegro MicroSystems, Inc. • 115 Northeast Cutoff, Worcester, MA 01606 USA • Phone: 1.508.853.5000 • Fax: 1.508.853.7895

## Looking for pricing, stock, or lifecycle information?

Click below to explore more details on WIN SOURCE:

- ⊖ [View A8737EEJTR-T on WIN SOURCE](#)
- ⊖ [Allegro MicroSystems, LLC Information](#)

## Optimize Your Supply Chain with WIN SOURCE Solutions

- ✓ Global Sourcing Solution
- ✓ Obsolete Management
- ✓ Cost Control Management
- ✓ Shortage Management
- ✓ Alternative Solution
- ✓ Excess Inventory Management