



**THE DATASHEET OF
AAT1219IWP-1-1.2-T1**



High Current Step-Up Converter with Adjustable Current Limit**General Description**

The AAT1219 is a high current synchronous boost converter with programmable low side MOSFET peak current limit of 500mA to 2.5A. It is ideal for preventing input current from overloading system power in PCI-E card applications based on WCDMA/Edge/GPRS/TD-SCDMA PCI-E card GSM high load pulse applications. With a suitable UltraCap or SuperCap, the AAT1219 ensures that output voltage meets load power requirements when large load pulses are applied. It is also ideal for CDMA/Evdo-A/Evdo-B and other industry modem continuous load current applications.

The output voltage of the adjustable version of the AAT1219 is programmed from 3.0V to 5.0V by an external resistive divider; the FB pin is left floating in the fixed output voltage version. Optimized internal compensation provides fast transient response with no external components. Light load switching frequency modulation and low quiescent current maintain high efficiency performance for light load mode conditions.

The low-side power MOSFET peak current limit of 500mA to 2.5A is set via an external resistor to protect the system power from overload. The high-side current limit operates in a linear mode to limit inrush current to 500mA.

Reverse blocking is integrated to prevent current from flowing back to the input. The AAT1219's true load disconnect function isolates the output from the input when the device is disabled. Output over-voltage, short-circuit, and over-temperature protection are also integrated to protect the AAT1219 from these fault conditions.

The AAT1219 is available in a Pb-free, 12-pin, low-profile TDFN33 package and is rated over the -40°C to 85°C temperature range.

Features

- V_{IN} Range: 2.4V to $V_{OUT} + 0.25V$
- V_{OUT} Range
 - Adjustable and Fixed Voltage Versions
 - Adjustable: 3.0V to 5.0V
- Programmable NMOS Peak Current Limit: 500mA to 2.5A
- Startup Inrush Current Limit: 500mA
- Reverse Current Blocking
- True Load Disconnect when Shutdown
- Up to 95% Efficiency
- 1.2MHz Switching Frequency
- Low $R_{DS(ON)}$
- Synchronous Boost Rectification and Internal Compensation
- Output Ready Indicator
- Fault Protection
 - Programmable Over-Voltage Protection
 - Short-Circuit Protection
 - Over-Temperature Protection
- Low-profile TDFN33-12 Package

Applications

- PC Cards (PCMCIA) Modems
- PCI-E Modem Cards
 - WCDMA/Edge/GPRS/TD-SCDMA
 - CDMA/Evdo-A/Evdo-B
 - Industry Modems
- USB Modems

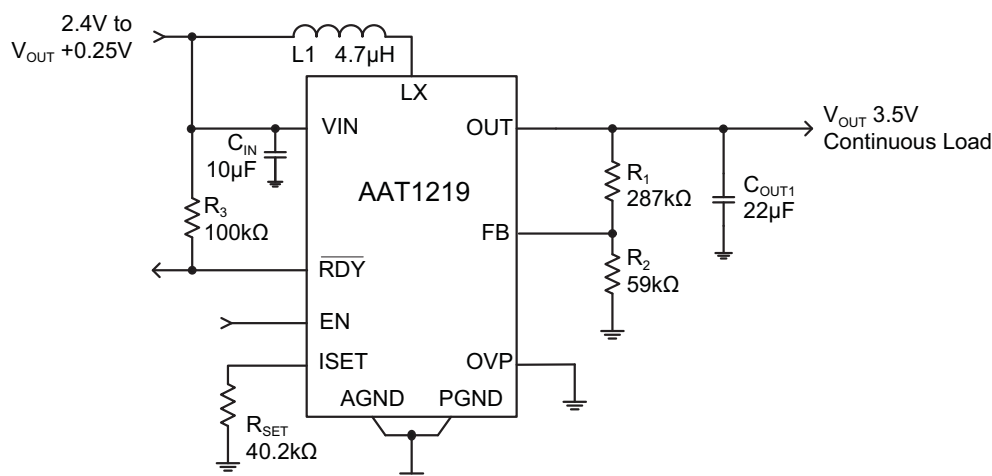
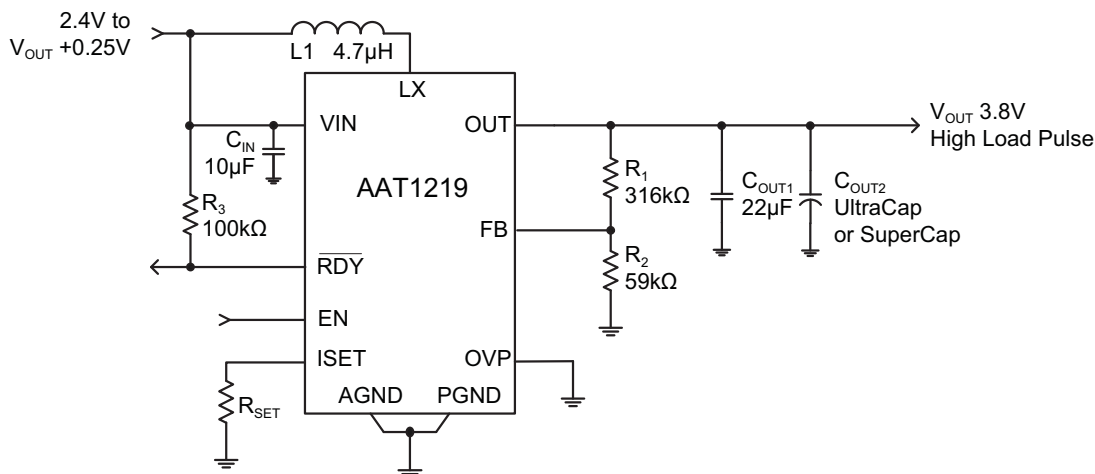
High Current Step-Up Converter with Adjustable Current Limit**Typical Application****Pin Descriptions**

Pin #	Symbol	Description
4	IN	Battery input voltage. Supplies the IC at startup.
1,2	LX	Switching node tied to drain of internal N-channel MOSFET and source of internal P-channel MOSFET. Connect this pin to the external power inductor.
8	FB	Feedback input pin. This pin is connected to an external resistor divider which programs the output voltage for adjustable version with feedback voltage of 0.6V.
10	OUT	Boost converter output voltage; connects to the P-channel synchronous MOSFET source. Bypass with ceramic capacitor to GND.
11, 12	PGND	Power ground.
7	AGND	Non-power signal ground pin.
3	EN	Input enable pin. Logic high to enable the boost. Logic low to disable the IC.
6	RDY	System ready pin. Open drain, active low, initiated when the output capacitor is 95% charged.
9	ISET	Peak current limit programmable input. An external resistor from ISET to ground is adopted to program the low-side MOSFET peak current limit between 500mA and 2.5A.
5	OVP	Over voltage protection pin. This pin is connected to an external resistor divider to set the over voltage threshold. To disable the over voltage feature, short this pin to ground.

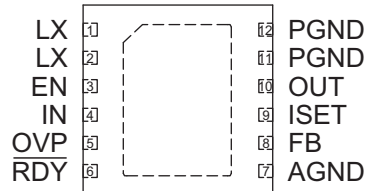
High Current Step-Up Converter with Adjustable Current Limit**Pin Configuration****TDFN33-12
(Top View)****Absolute Maximum Ratings¹**

Symbol	Description	Value	Units
	LX, VIN, EN, $\overline{\text{RDY}}$, FB Voltage to PGND	-0.3 to 6.0	V
	PGND Voltage to GND	-0.3 to 0.3	V
T_J	Operating Junction Temperature Range	-40 to 150	°C
T_S	Storage Temperature Range	-65 to 150	°C
T_{LEAD}	Maximum Soldering Temperature (at leads, 10 sec)	300	°C

Thermal Information

Symbol	Description	Value	Units
P_D	Maximum Power Dissipation ²	2	W
Θ_{JA}	Maximum Thermal Resistance ³	50	°C/W

1. Stresses above those listed in Absolute Maximum Ratings may cause permanent damage to the device. Functional operation at conditions other than the operating conditions specified is not implied. Only one Absolute Maximum rating should be applied at any one time.
2. Mounted on 1.6mm thick FR4 circuit board.
3. Derate 25mW/°C above 25 °C ambient temperature.

High Current Step-Up Converter with Adjustable Current Limit

Electrical Characteristics

$V_{IN} = 3.3V$, $C_{IN} = 10\mu F$, $C_{OUT} = 22\mu F$, $L = 4.7\mu H$, $T_A = 25^\circ C$ unless otherwise noted.

Symbol	Description	Conditions	Min	Typ	Max	Units
V_{IN}	Minimum Start-Up Voltage			2.3	2.4	V
V_{OUT_RANGE}	Output Voltage Range		3.0		5.0	V
V_{OP}	Input Operating Voltage Range		2.4		$V_{OUT} + 0.25$	V
V_{UVLO}	UVLO Threshold	V_{IN} Rising		2.1	2.3	V
		Hysteresis		100		mV
I_Q	Quiescent Supply Current	No Load, No Switching		58	80	μA
I_{SHDN}	Shutdown Current	$EN = 0V$, $V_{IN} = 5.5V$		0.01	1	μA
V_{FB_ACC}	Feedback Voltage Accuracy	$T_A = 25^\circ C$, $V_{FB} = 600mV$	-2		2	%
		$T_A = -40^\circ C$ to $+85^\circ C$, $V_{FB} = 600mV$	-3		3	%
$\frac{\Delta V_{OUT}}{\Delta I_{OUT}}$	Load Regulation	0A to 1.2A, $V_{OUT} = 3.8V$		0.5		%
$\frac{\Delta V_{OUT}}{\Delta V_{IN}}$	Line Regulation	$V_{IN} = 2.4V$ to V_{OUT}		0.2		%/V
$R_{DS(ON)_N}$	NMOS Switch On Resistance	$V_{OUT} = 3.8V$		250		m Ω
$R_{DS(ON)_P}$	PMOS Switch On Resistance	$V_{OUT} = 3.8V$		300		m Ω
V_{OVP}	Over-Voltage Protection Threshold	V_{OVP} Rising, $T_A = 25^\circ C$	570	600	630	mV
		V_{OVP} Hysteresis		20		mV
$I_{LIMIT,P}$	PMOS Current Limit	$V_{OUT} = 0V$		500		mA
$I_{LIMIT,N}$	NMOS Current Limit	$R_{SET} = 100k\Omega$	0.8	1.0	1.2	A
F_{OSC}	Switching Frequency			1.2		MHz
D_{TYMAX}	Maximum Duty Cycle			90		%
Logic						
$V_{EN(L)}$	Logic Input Low Threshold for EN				0.4	V
$V_{EN(H)}$	Logic Input High Threshold for EN		1.4			V
I_{EN}	Enable Input Low Current	$V_{IN} = V_{OUT} = 5.5V$	-1.0		1.0	μA
V_{RDY}	\overline{RDY} Threshold	V_{OUT} Rising		95		% V_{OUT}
		V_{OUT} Hysteresis		10		% V_{OUT}
Thermal						
T_{SD}	Over-Temperature Shutdown Threshold			140		$^\circ C$
$T_{SD(HYS)}$	Over-Temperature Shutdown Hysteresis			15		$^\circ C$

High Current Step-Up Converter with Adjustable Current Limit

Typical Characteristics

$L = 4.7\mu\text{H}$, $C_{\text{OUT}} = 22\mu\text{F}$.

Input Current vs. Input Voltage
($V_{\text{OUT}} = 3.8\text{V}$)

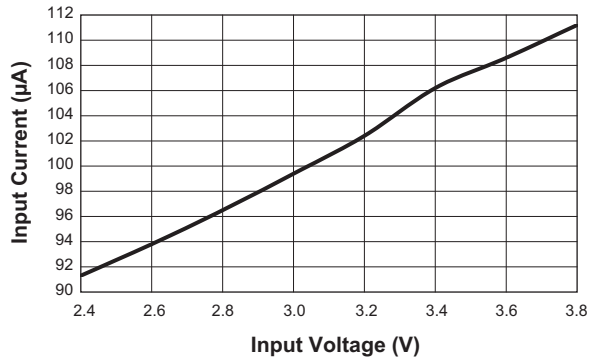

Input Current vs. Input Voltage
($V_{\text{OUT}} = 5\text{V}$)

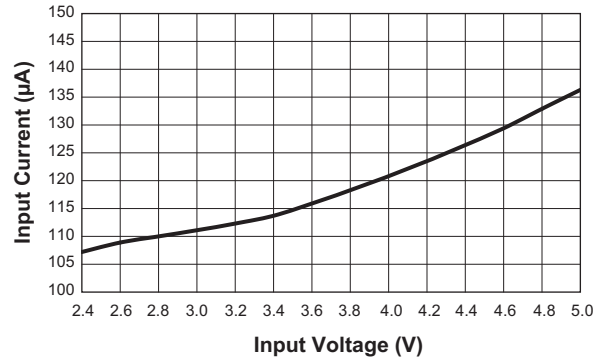

Quiescent Current vs. Temperature
(Measured from V_{OUT})

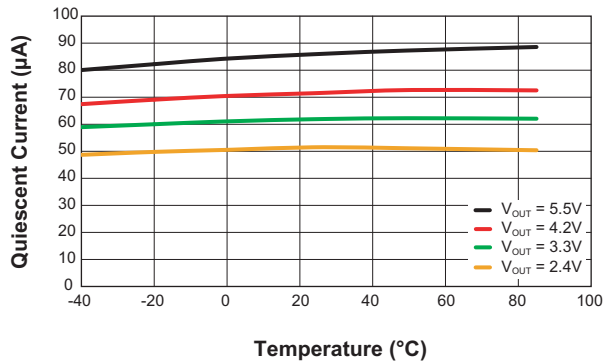

Efficiency vs. Output Current
($V_{\text{OUT}} = 3.3\text{V}$)

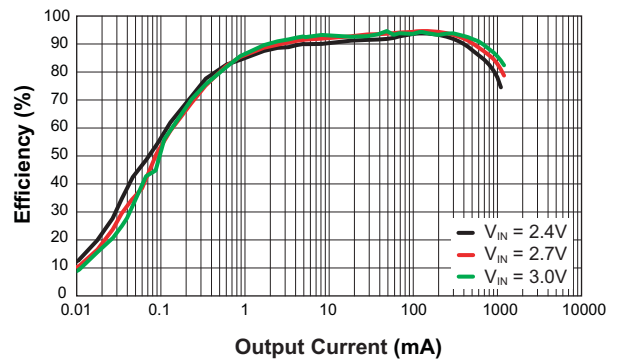

Efficiency vs. Output Current
($V_{\text{OUT}} = 3.8\text{V}$)

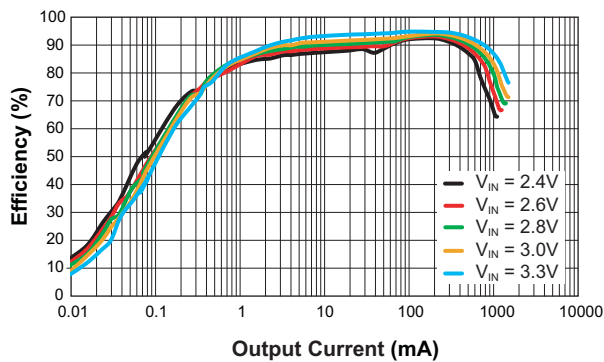

Efficiency vs. Output Current
($V_{\text{OUT}} = 5.0\text{V}$)

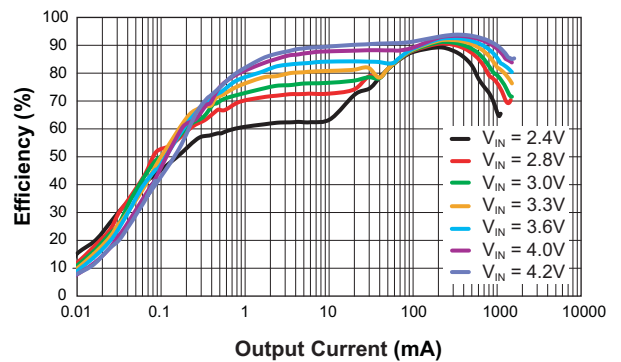

High Current Step-Up Converter with Adjustable Current Limit

Typical Characteristics

$L = 4.7\mu\text{H}$, $C_{\text{OUT}} = 22\mu\text{F}$.

Load Regulation vs. Output Current
($V_{\text{OUT}} = 3.8\text{V}$)

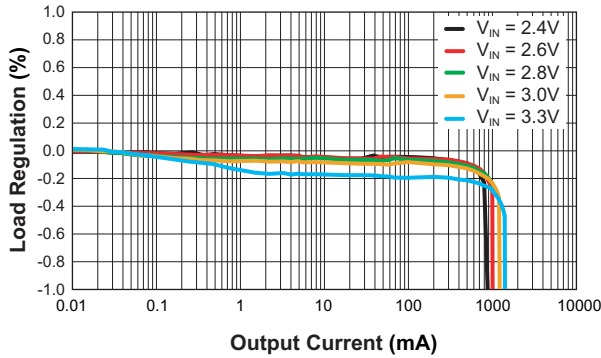

Load Regulation vs. Output Current
($V_{\text{OUT}} = 5.0\text{V}$)

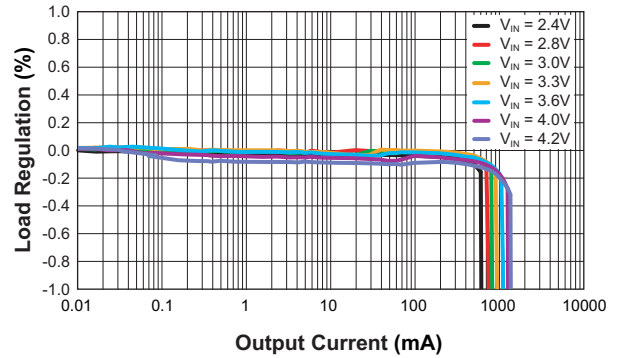

Feedback Voltage vs. Input Voltage

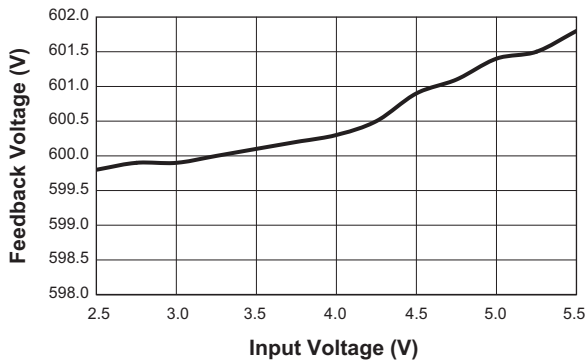

Feedback Voltage Error vs. Temperature

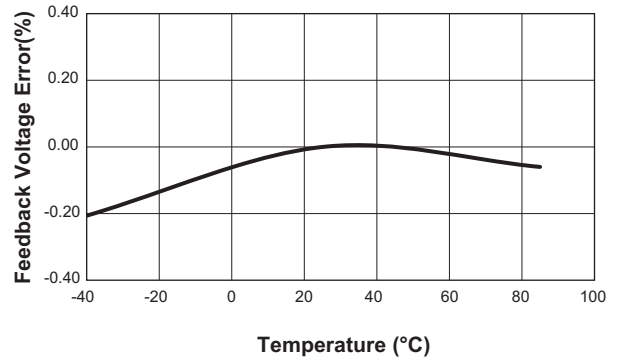

$V_{\text{EN(H)}}$ vs. Temperature
($V_{\text{IN}} = 3.6\text{V}$; $V_{\text{OUT}} = 5\text{V}$)

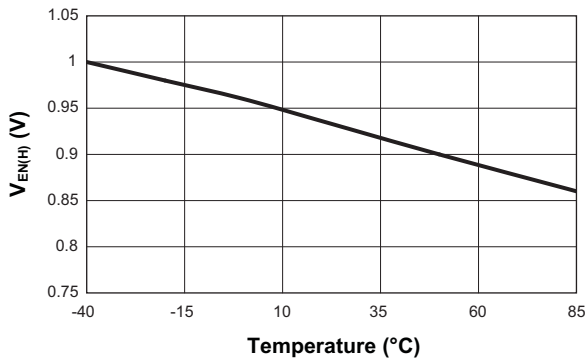

$V_{\text{EN(L)}}$ vs. Temperature
($V_{\text{IN}} = 3.6\text{V}$; $V_{\text{OUT}} = 5\text{V}$)

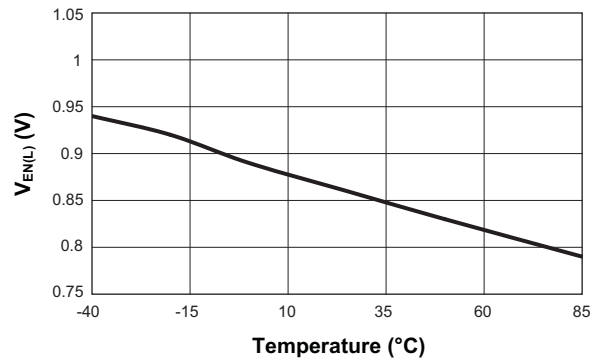

High Current Step-Up Converter with Adjustable Current Limit

Typical Characteristics

$L = 4.7\mu\text{H}$, $C_{\text{OUT}} = 22\mu\text{F}$.

$R_{\text{DS(ON)_P}}$ vs. Input Voltage

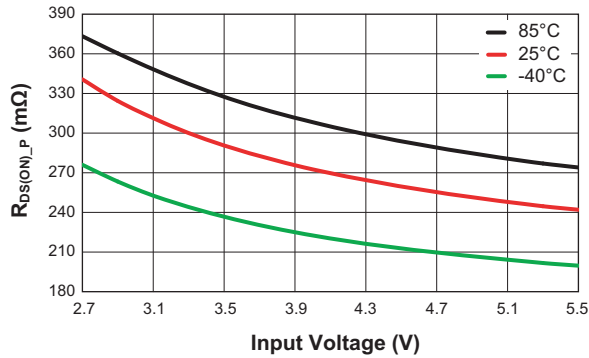

$R_{\text{DS(ON)_N}}$ vs. Input Voltage

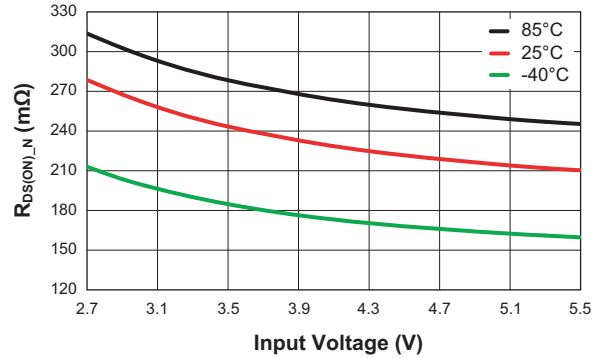

Enable Threshold vs. Input Voltage

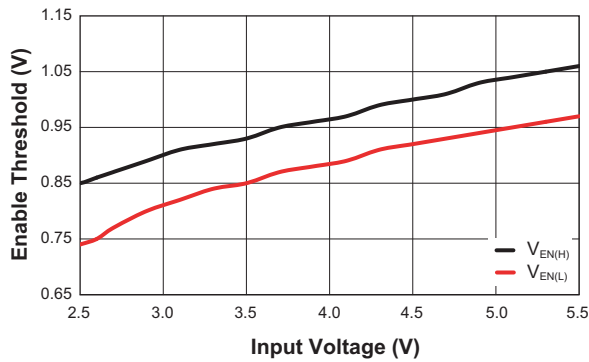

Switching Frequency vs. Temperature
($V_{\text{IN}} = 3.6\text{V}$; $V_{\text{OUT}} = 5\text{V}$)

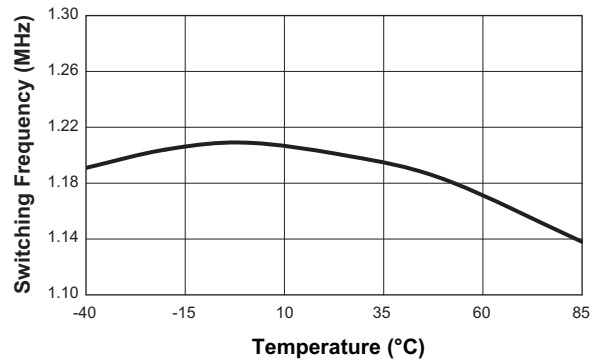

Line Transient

($V_{\text{IN}} = 2.4\text{V}$ to 3.3V ; $V_{\text{OUT}} = 3.8\text{V}$; $I_{\text{OUT}} = 200\text{mA}$; $C_{\text{FF}} = 0\text{pF}$)

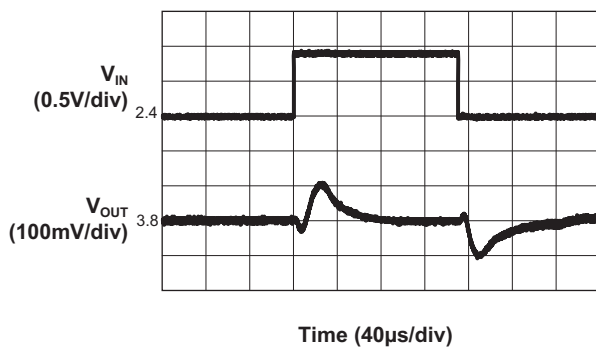

Load Transient

($V_{\text{IN}} = 3.3\text{V}$; $V_{\text{OUT}} = 3.8\text{V}$; $C_{\text{FF}} = 47\text{pF}$)

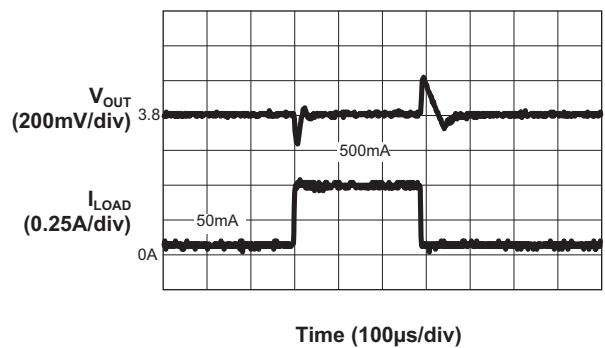

High Current Step-Up Converter with Adjustable Current Limit

Typical Characteristics

$L = 4.7\mu\text{H}$, $C_{\text{OUT}} = 22\mu\text{F}$.

Soft Start
($V_{\text{IN}} = 3.6\text{V}$; $V_{\text{OUT}} = 5\text{V}$; $I_{\text{OUT}} = 100\text{mA}$)

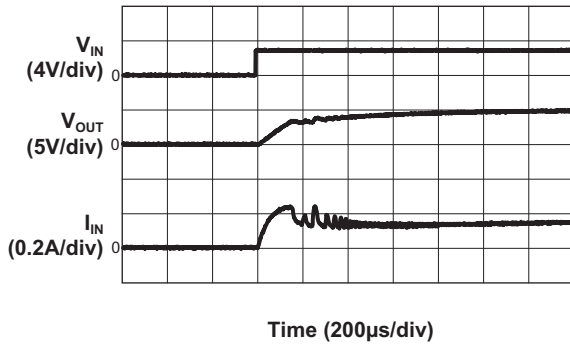

Output Ripple
($V_{\text{IN}} = 3.3\text{V}$; $V_{\text{OUT}} = 3.8\text{V}$; $I_{\text{OUT}} = 1\text{mA}$)

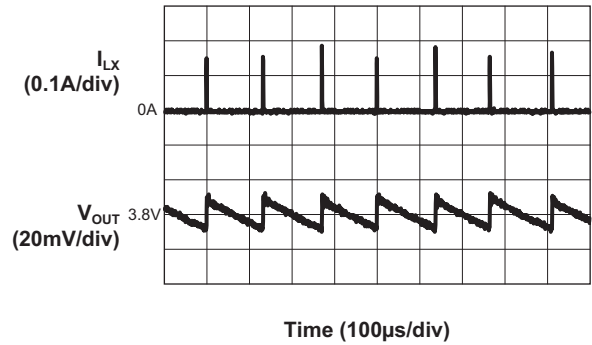

Output Ripple
($V_{\text{IN}} = 3.3\text{V}$; $V_{\text{OUT}} = 3.8\text{V}$; $I_{\text{OUT}} = 500\text{mA}$)

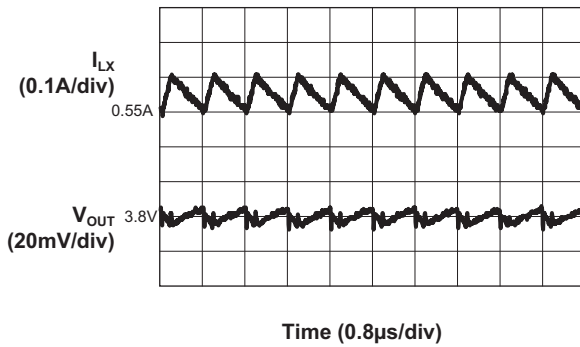

Maximum Output Current vs. Input Voltage
($V_{\text{OUT}} = 3.8\text{V}$; $C_{\text{FF}} = 0\text{F}$)

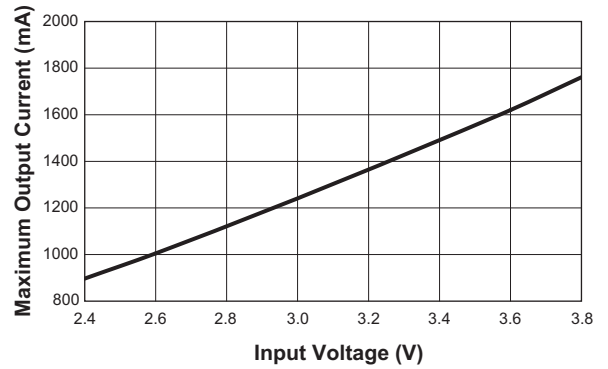

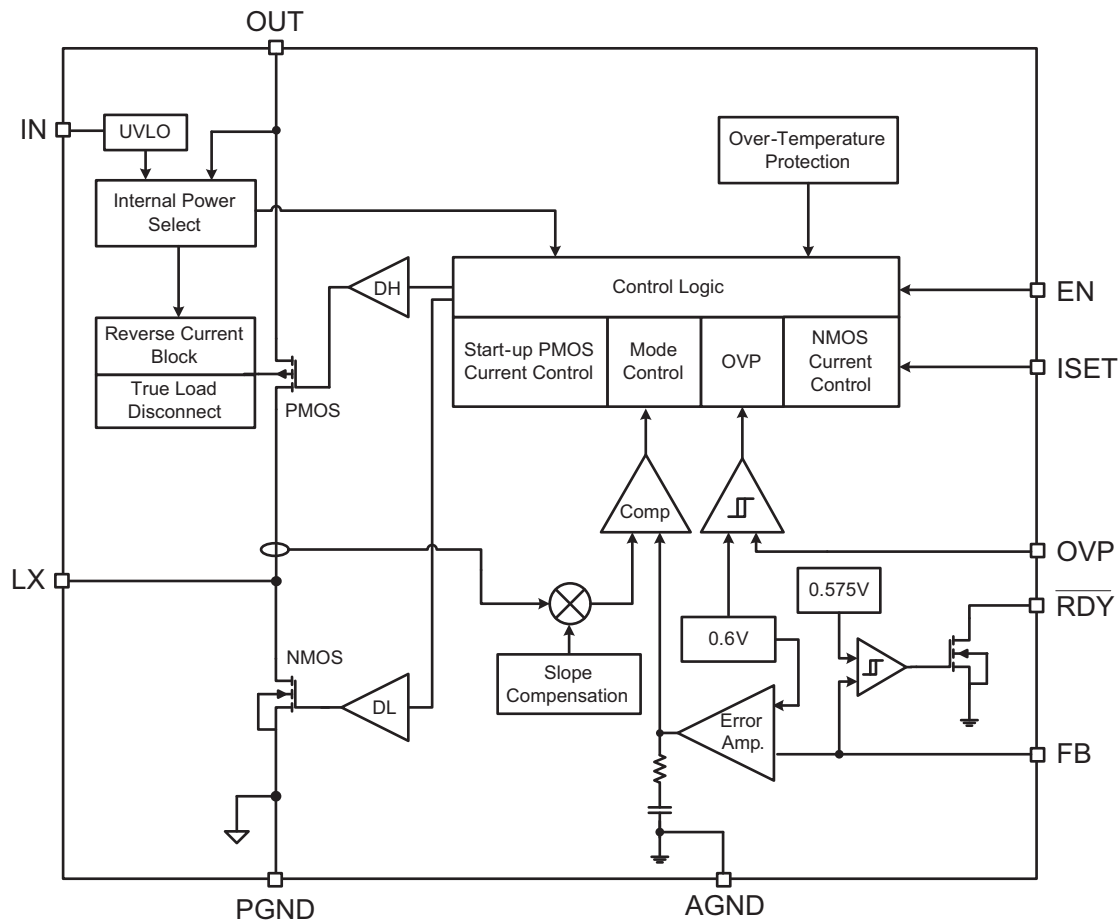
High Current Step-Up Converter with Adjustable Current Limit**Functional Block Diagram****Functional Description**

The AAT1219 synchronous step-up converter is targeted for PC card GSM/GPRS/3G and WiMax modem card applications. It includes two current limits to ensure fast, controlled startup and continuous operation with the PCMCIA specifications.

The high 1.2MHz switching frequency of the AAT1219 facilitates output filter component size reduction for improved power density and reduced overall footprint. It also provides greater bandwidth and improved transient

response over other lower frequency step-up converters. The compensation and feedback is integrated with only three external components (C_{IN} , C_{OUT} , L). Low $R_{DS(ON)}$ synchronous power switches provide high efficiency for heavy load conditions. Switching frequency modulation and low quiescent current maintains this high efficiency for light load mode condition. In addition to the improved efficiency, the synchronous rectifier has the added performance advantage of true load disconnect during shutdown ($<1\mu A$ shutdown current), reverse current blocking, inrush current limit, and short-circuit protection.

High Current Step-Up Converter with Adjustable Current Limit**PWM/Light Load Control**

The AAT1219 is a fixed frequency PWM peak current mode control step-up converter. For light load condition (70 to 80mA and below), the converter remains in variable frequency (Light Load) mode to reduce the dominant switching losses. In addition to Light Load operation, a zero current comparator blocks reverse current in the P-channel synchronous MOSFET and no noise control removes the EMI effect caused by inductor current ring. These controls, along with very low quiescent current, help to maintain high efficiency over the complete load range without increased output voltage ripple during light load conditions.

Start-up and Inrush Current Limit

When the AAT1219's output voltage is less than the input voltage at start-up, the device operates the limited P-channel power MOSFET in a linear status to charge large output capacitive loads. The fixed current limit of the PMOS controls the maximum input inrush current to 500mA until output voltage is above input voltage. After V_{OUT} exceeds V_{IN} , the converter enters step-up status with internal circuitry power changed from V_{IN} to V_{OUT} .

Programmable NMOS Peak Current Limit

When the output voltage of the AAT1219 is in boost mode with the output voltage greater than the input voltage, the NMOS peak current limit takes over. During the inductor charge cycle, the current through the NMOS device is sensed. When this current reaches the value set by the R_{SET} resistor, the low-side NMOS switch is turned off. The NMOS current limit is an instantaneous peak current measurement and should be set high enough to allow the desired average current. The applications section discusses proper selection of R_{SET} resistor values.

True Load Disconnect and Shutdown

A typical synchronous step-up (boost) converter has a conduction path from the input to the output via the parasitic body diode of the P-channel MOSFET when the converter shuts down. The AAT1219 design uses a special power selection for the substrate to keep the parasitic body diode in off-state during shutdown and startup. This enables the AAT1219 to provide true load disconnect during shutdown and inrush current limit at startup.

When EN is set to logic low, the step-up converter is forced into shutdown state with less than 1 μ A input current.

Short-Circuit Protection

When a short-circuit fault occurs and the AAT1219 detects that the V_{OUT} voltage is lower than V_{IN} minus 400mV, the internal control circuit changes the device operation status from normal PWM regulation to startup status with startup current limit active to limit the input current. When the fault is removed, AAT1219 recovers to normal operation automatically.

Over-Temperature Protection

An over-temperature event occurs when the AAT1219's junction temperature exceeds the over-temperature protection threshold. In the case, the AAT1219's over-temperature protection circuitry completely disables switching and the PMOS current limit serves to control the current level to avoid damage to the step-up converter. When the over-temperature fault condition is removed, the boost recovers regulation automatically.

Power Ready Indicator (\overline{RDY})

To indicate output voltage OK, an open-drain output \overline{RDY} pin is designed to pull down when the output voltage increases to 95% of the nominal voltage level. The pin will be pulled up when the output voltage drops below 87% of the nominal output level.

High Current Step-Up Converter with Adjustable Current Limit

Application Information

R_{SET} Selection for Current Limit Programming

The current limit of the internal low-side NMOS power switch is programmable from 500mA to 2.5A by an external resistor connected from ISET to ground. The resistor value can be calculated using the following formula:

$$R_{SET} = \frac{10^5}{I_{LIM}}$$

When the inductor's peak current reaches the current limit, the RDY indicator is pulled high. Table 1 gives standard 1% standard metal film resistor example values for NMOS current limit programming.

NMOS Peak Current Limit (A)	R _{SET} (kΩ)
0.5	200
0.6	165
0.7	143
0.8	124
0.9	110
1.0	100
1.25	78.7
1.5	66.5
1.75	56.2
2.0	49.9
2.25	44.2
2.5	40.2

Table 1: 1% Standard R_{SET} Value Examples for NMOS Current Limit Programming

Output Voltage Programming

The output voltage of the AAT1219 adjustable version may be programmed from 3.0V to 5.5V with an external resistor divider. Resistors R1 and R2 in Figure 2 program the output voltage as shown by the following equation:

$$R_1 = \frac{R_2 \cdot V_{OUT}}{0.6} - R_2$$

0.6V is the feedback reference voltage. To limit the bias current required for the external feedback resistor string while maintaining good noise immunity, the suggested value for R2 is 59kΩ. Table 2 summarizes the resistor values with R2 set to 59kΩ for good noise immunity and 6μA increased load current and gives some 1% standard metal film resistor values for R1 at different output voltage settings.

V _{OUT} (V)	R2 = 59kΩ R1 (kΩ)
3.3	267
3.6	294
3.7	309
3.8	316
4.0	340
4.2	353
5.0	432

Table 2: 1% Standard Resistor Examples for Different Output Voltages.

Over-Voltage Protection

The AAT1219's over-voltage protection function prevents the output voltage from exceeding the programmed over-voltage point via an external resistor divider when output voltage has the possible risk of over-shoot. Resistors R3 and R4 in Figure 2 program the over-voltage trip point. 100kΩ is a good resistance for R4 with good noise immunity and reduced no load input current. Calculate the value of R3 using the following formula:

$$R_3 = \frac{R_4 \cdot V_{OUT_OVP}}{0.6} - R_4$$

As an example, for a 5.5V OVP setting, R3 is 820kΩ when R4 is 100kΩ. If the over-voltage protection function is not used, connect the OVP pin to ground.

Inductor Selection

The AAT1219 is designed to operate with a 4.7μH inductor for all input/output voltage combinations. For high efficiency, choose a ferrite inductor with a high frequency core material to reduce core losses. The inductor should have low ESR (equivalent series resistance) to reduce the I²R losses, and must be able to handle the peak inductor current without saturating. To minimize radiated noise, use a shielded inductor.

Input Capacitor

Select a low ESR ceramic capacitor with a value of at least 10μF as the input capacitor. The input capacitor should be placed as close to the VIN and PGND pins as possible in order to minimize the stray resistance from the converter to the input power source.

High Current Step-Up Converter with Adjustable Current Limit

Output Capacitor

The output capacitor provides energy to the load when the high-side MOSFET is switched off. The output capacitance together with the boost switching frequency, duty cycle, and load current value determine the output voltage ripple when the boost operation is in the continuous PWM state.

$$\Delta V_{OUT} = \frac{I_{OUT} \cdot D}{C_{OUT} \cdot f_{SW}}$$

D is the duty ratio of low-side MOSFET turn-on time divided by the switching period. It is calculated using the equation

$$D = 1 - \frac{V_{IN}}{V_{OUT}}$$

The output capacitor's ESR increases the output ripple by $I_{OUT} \cdot ESR$. The total output ripple is:

$$\Delta V_{OUT} = \frac{I_{OUT} \cdot D}{C_{OUT} \cdot f_{SW}} + I_{OUT} \cdot ESR$$

So the minimum output capacitor value is:

$$C_{OUT_MIN} = \frac{(\Delta V_{OUT} - I_{OUT} \cdot ESR) \cdot f_{SW}}{D \cdot I_{OUT}}$$

High Load Pulse Application

Together with a large value output capacitor or supercap, the AAT1219 can support a higher load pulse in lower input current limited applications such as GSM burst mode in WCDMA, Edge, GPRS and TD-SCDMA applications. The large capacitance is determined by NMOS peak current limit, inductor current ripple, V_{IN} , V_{OUT} , load pulse high current level and elapsed time. It can be calculated as follows:

First calculate the AAT1219's load current from on the expected I_{LIM} based on an approximation of input current equaling I_{LIM} because the inductor current ripple is low enough when compared to the input current:

$$I_{OUT_BOOST} = \frac{V_{IN} \cdot I_{LIM} \cdot \eta}{V_{OUT}}$$

Second, calculate the maximum current the large capacitor C_{OUT} should provide:

$$I_{COUT} = I_{LOAD_PEAK} - I_{OUT_BOOST}$$

Finally, derive the C_{OUT} at a certain load on period T_{ON} :

$$C_{OUT} = \frac{I_{COUT} \cdot T_{ON}}{\Delta V_{OUT}}$$

To consider the real tantalum capacitor having 20% tolerance, the selected capacitance should be 20% higher than the calculated value.

Example: A 2A, 217Hz 12.5% duty cycle load pulse is applied on 3.8V V_{OUT} at 3.3V V_{IN} . An input peak current limit of 1.1A and a V_{OUT} drop of less than 450mV are required. Under these conditions, with 89% efficiency, the AAT1219's output current is

$$I_{OUT_BOOST} = \frac{3.3 \cdot 1 \cdot 89\%}{3.8} = 0.85A$$

The maximum current necessary for the large capacitor value is:

$$I_{COUT} = 2 - 0.85 = 1.15A$$

T_{ON} is 577 μ s for a 217Hz 12.5% duty cycle load pulse.

Considering 20% capacitance tolerance, the minimum capacitance should be 1843 μ F. Figure 1 shows the AAT1219 operating waveform under a 2A 577 μ s load pulse with 6x330 μ F tantalum capacitor as C_{OUT} , as well as a 22 μ F ceramic capacitor to closely filter the output voltage.

Supercapacitors have large capacitance and can also be used in this application. One supercapacitor has a maximum voltage of 1V or 2.5V depending on its electrode material types (aqueous or organic). For higher voltage applications, supercapacitors are connected in series. To prevent any cell from charging over-voltage, a balance resistor is required on a string of more than three cells.

AAT1219

High Current Step-Up Converter with Adjustable Current Limit

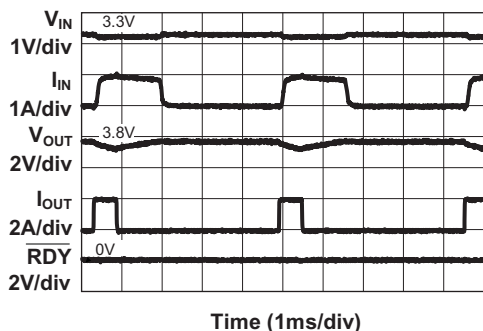

Figure 1: AAT1219 Operation Waveform When 2A 577 μ s Load Pulse is Applied.

Layout Guidance

For best performance of the AAT1219, the following guidelines should be followed when designing the PCB layout:

1. Make the power trace as short and wide as possible, including the input/output power lines and switching node, etc.
2. Connect the analog and power grounds together with a single short line and connect all low current loop grounds to analog ground to decrease the power ground noise on the analog ground and achieve better load regulation.
3. For good power dissipation, the exposed pad under the package should be connected to the top and bottom ground planes by PCB vias.

Evaluation Board Schematic

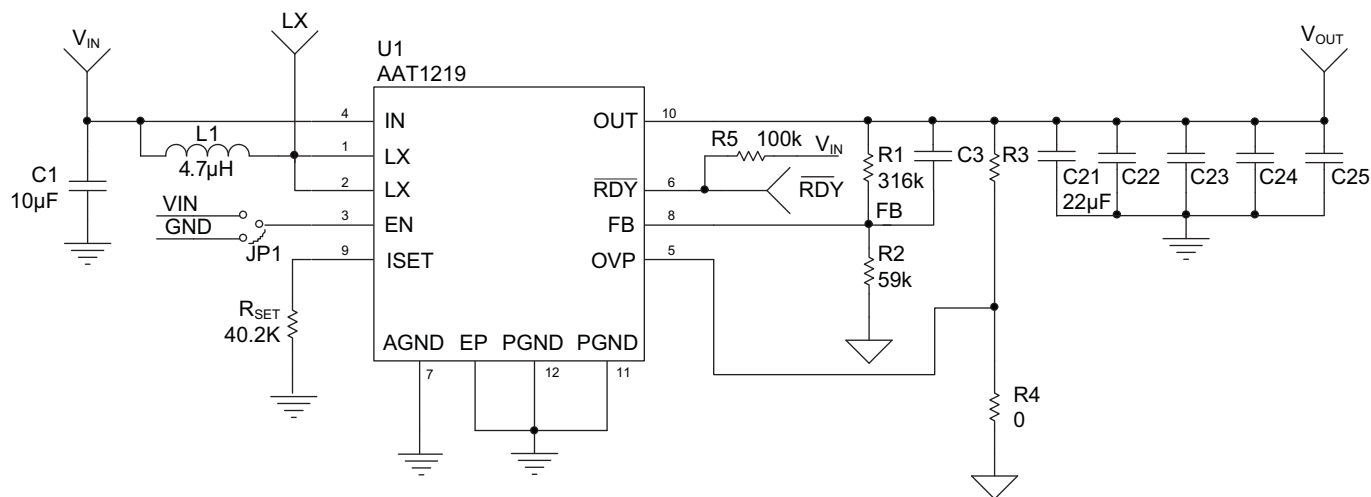

Figure 2: AAT1219 Evaluation Board Schematic.

High Current Step-Up Converter with Adjustable Current Limit

Evaluation Board Layout

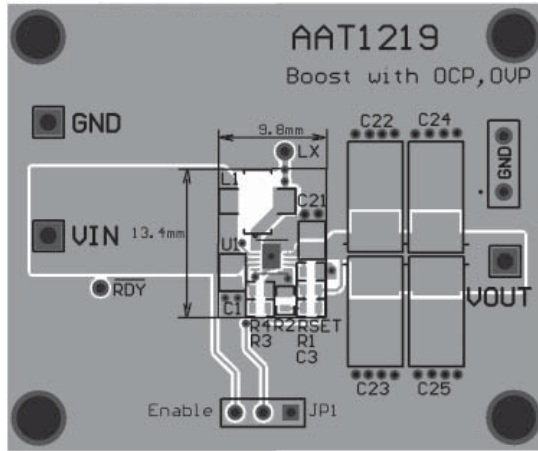

Figure 3: AAT1219 Evaluation Board Top Side Layout.

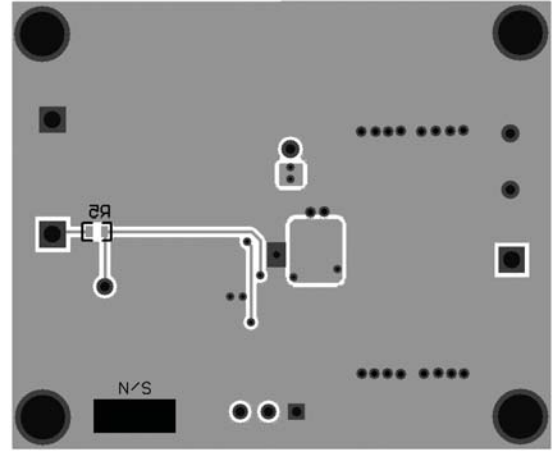

Figure 4: AAT1219 Evaluation Board Bottom Side Layout

Component	Part Number	Description	Manufacturer
U1	AAT1219IWP-1-1.2	High Current Step-Up Converter with Adjustable Current Limit	Skyworks
R1	RC0603FR-07316KL	Res 316kΩ 1/10W 1% 0603 SMD	Yageo
R2	RC0603FR-0759KL	Res 59kΩ 1/10W 1% 0603 SMD	
R4	RC0603FR-070RL	Res 0Ω 1/10W 1% 0603 SMD	
R5	RC0603FR-07100KL	Res 100kΩ 1/10W 1% 0603 SMD	
RSET	RC0603FR-0740K2L	Res 40.2kΩ 1/10W 1% 0603 SMD	
C1	GRM21BR61C106K	Cap Ceramic 10μF 0805 X5R 16V 10%	Murata
C21	GRM21BR60J226M	Cap Ceramic 22μF 0805 X5R 6.3V 20%	
L1	SD53-4R7	Inductor 4.7μH 2.1A SMD	Coiltronics
R3, C3, C22, C23, C24, C25	Not Populated		

Table 3: AAT1219 Evaluation Board Bill of Materials.

Manufacturer	Part Number	L (μH)	Max DCR (mΩ)	Saturation Current (A)	Size WxLxH (mm)
Coiltronics	SD3118	4.7	162	1.31	3.1x3.1x1.8
	SD53	4.7	45	2.1	5.2x5.2x3.0
	SD8328	4.7	24.7	3.6	8.3x9.5x3.0
Sumida	CDRH4D14HPNP	4.7	140	1.4	4.6x4.6x1.5
	CDRH4D22	4.7	82.6	2.2	5.0x5.0x2.4
	CDRH8D28	4.7	19	3.4	8.3x8.3x3.0
Coilcraft	LPS4018	4.7	125	1.9	4.0x4.0x1.7
	LPS5030	4.7	83	2.0	4.8x4.8x2.9

Table 4: Surface Mount Inductors.

High Current Step-Up Converter with Adjustable Current Limit

Manufacturer	Part Number	Value (μ F)	Voltage	Tolerance	Temp. Co.	ESR (m Ω)	Case
Murata	GRM21BR60J226ME39	22	6.3	20%	X5R	26	0805
AVX	TAJD337M006R	330	6.3	20%	X5R	400	7343
	TPSD337M006R0150	330	6.3	20%	X5R	150	7343
	TAJD477M006R	470	6.3	20%	X5R	400	7343
	TPSD477M006R0150	470	6.3	20%	X5R	150	7343
	TAJD687M006R	680	6.3	20%	X5R	500	7343
	TPSD687M006R0100	680	6.3	20%	X5R	100	7343
KEMET	T491D337M006AT	330	6.3	20%	X5R	400	7343
	T495D337M006ATE100	330	6.3	20%	X5R	100	7343
	T491D477M006AT	470	6.3	20%	X5R	400	7343
	T495D477M006ATE150	470	6.3	20%	X5R	150	7343
	T491D687M006ZT	680	6.3	20%	X5R	500	7343
	T495D687M006ZTE150	680	6.3	20%	X5R	150	7343

Table 5: Surface Mount Capacitors.

Manufacturer	Part Number	Capacitance (mF)	Rated Voltage (V)	ESR (m Ω)	Size WxLxH (mm)
Cap-xx http://www.cap-xx.com/	GZ 215F	75	4.5	150	20x15x2.6
	HS 203F	250	5.5	70	39x17x2.15
	HS 211F	370	5.5	55	39x17x2.9
	HS 206F	600	5.5	70	39x17x2.4
	HW 207F	450	5.5	100	28.5x17x2.9

Table 6: Supercapacitors.

High Current Step-Up Converter with Adjustable Current Limit

Ordering Information

Package	Output Voltage	Feedback Voltage	Marking ¹	Part Number (Tape and Reel) ²
TDFN33-12	Adjustable	0.6V	8VXY	AAT1219IWP-1-1.2-T1



Skyworks Green™ products are compliant with all applicable legislation and are halogen-free. For additional information, refer to *Skyworks Definition of Green™*, document number SQ04-0074.

Package Information

TDFN33-12³

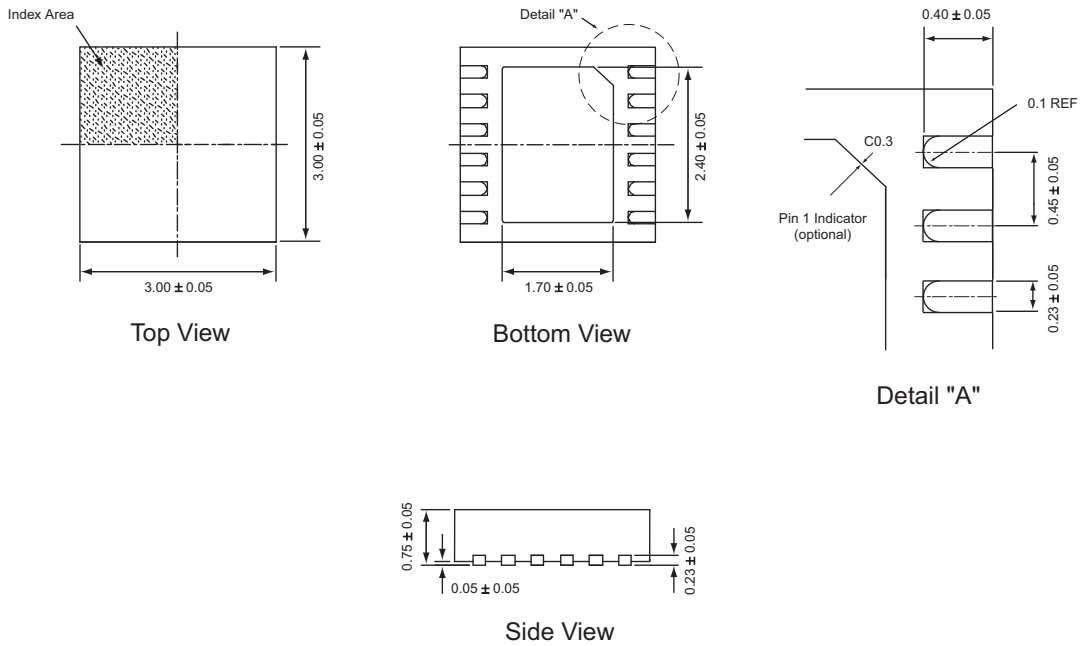

All dimensions in millimeters.

1. XY = assembly and date code.
 2. Sample stock is generally held on part numbers listed in **BOLD**.
 3. The leadless package family, which includes QFN, TQFN, DFN, TDFN and STDFN, has exposed copper (unplated) at the end of the lead terminals due to the manufacturing process. A solder fillet at the exposed copper edge cannot be guaranteed and is not required to ensure a proper bottom solder connection.

High Current Step-Up Converter with Adjustable Current Limit

Copyright © 2012 Skyworks Solutions, Inc. All Rights Reserved.

Information in this document is provided in connection with Skyworks Solutions, Inc. ("Skyworks") products or services. These materials, including the information contained herein, are provided by Skyworks as a service to its customers and may be used for informational purposes only by the customer. Skyworks assumes no responsibility for errors or omissions in these materials or the information contained herein. Skyworks may change its documentation, products, services, specifications or product descriptions at any time, without notice. Skyworks makes no commitment to update the materials or information and shall have no responsibility whatsoever for conflicts, incompatibilities, or other difficulties arising from any future changes.

No license, whether express, implied, by estoppel or otherwise, is granted to any intellectual property rights by this document. Skyworks assumes no liability for any materials, products or information provided hereunder, including the sale, distribution, reproduction or use of Skyworks products, information or materials, except as may be provided in Skyworks Terms and Conditions of Sale.

THE MATERIALS, PRODUCTS AND INFORMATION ARE PROVIDED "AS IS" WITHOUT WARRANTY OF ANY KIND, WHETHER EXPRESS, IMPLIED, STATUTORY, OR OTHERWISE, INCLUDING FITNESS FOR A PARTICULAR PURPOSE OR USE, MERCHANTABILITY, PERFORMANCE, QUALITY OR NON-INFRINGEMENT OF ANY INTELLECTUAL PROPERTY RIGHT; ALL SUCH WARRANTIES ARE HEREBY EXPRESSLY DISCLAIMED. SKYWORKS DOES NOT WARRANT THE ACCURACY OR COMPLETENESS OF THE INFORMATION, TEXT, GRAPHICS OR OTHER ITEMS CONTAINED WITHIN THESE MATERIALS. SKYWORKS SHALL NOT BE LIABLE FOR ANY DAMAGES, INCLUDING BUT NOT LIMITED TO ANY SPECIAL, INDIRECT, INCIDENTAL, STATUTORY, OR CONSEQUENTIAL DAMAGES, INCLUDING WITHOUT LIMITATION, LOST REVENUES OR LOST PROFITS THAT MAY RESULT FROM THE USE OF THE MATERIALS OR INFORMATION, WHETHER OR NOT THE RECIPIENT OF MATERIALS HAS BEEN ADVISED OF THE POSSIBILITY OF SUCH DAMAGE.

Skyworks products are not intended for use in medical, lifesaving or life-sustaining applications, or other equipment in which the failure of the Skyworks products could lead to personal injury, death, physical or environmental damage. Skyworks customers using or selling Skyworks products for use in such applications do so at their own risk and agree to fully indemnify Skyworks for any damages resulting from such improper use or sale.

Customers are responsible for their products and applications using Skyworks products, which may deviate from published specifications as a result of design defects, errors, or operation of products outside of published parameters or design specifications. Customers should include design and operating safeguards to minimize these and other risks. Skyworks assumes no liability for applications assistance, customer product design, or damage to any equipment resulting from the use of Skyworks products outside of stated published specifications or parameters.

Skyworks, the Skyworks symbol, and "Breakthrough Simplicity" are trademarks or registered trademarks of Skyworks Solutions, Inc., in the United States and other countries. Third-party brands and names are for identification purposes only, and are the property of their respective owners. Additional information, including relevant terms and conditions, posted at www.skyworksinc.com, are incorporated by reference.

Looking for pricing, stock, or lifecycle information?

Click below to explore more details on WIN SOURCE:

- ⊖ [View AAT1219IWP-1-1.2-T1 on WIN SOURCE](#)
- ⊖ [Skyworks Solutions Inc. Information](#)

Optimize Your Supply Chain with WIN SOURCE Solutions

- ✓ Global Sourcing Solution
- ✓ Obsolete Management
- ✓ Cost Control Management
- ✓ Shortage Management
- ✓ Alternative Solution
- ✓ Excess Inventory Management