



**THE DATASHEET OF
AAT1236IRN-T1**



High Efficiency White LED Drivers for Backlight and Keypad

General Description

The AAT1236 is a highly integrated, high efficiency power solution for white LED and keypad backlights in mobile/portable devices. It is based on a switching boost converter which steps up the single cell lithium-ion/polymer battery voltage to drive 5 strings of series-connected white LEDs with precision current regulation. The AAT1236 is capable of driving a total of four LEDs per channel.

The boost converter can produce an output drive of up to 24V at 100mA. The high switching frequency (up to 2MHz) provides fast response to load transients and allows the use of small external components. A fully integrated control circuit simplifies the design and reduces total solution size.

A two-wire I²C serial digital interface is used to individually turn each output sink on/off and adjust the LED current by group. Unlike conventional pulse width modulation (PWM) control of LED brightness, the AAT1236 drives the LEDs with constant, non-pulsating current. The interface is fully compliant to the Fast/Standard mode I²C specification, allowing a transfer rate of up to 400kHz.

A similar device is also available with a proprietary Advanced Simple Serial Control™ (AS²Cwire™) single wire interface; please see the AAT1235 datasheet.

The AAT1236 is available in a Pb-free, thermally-enhanced 16-pin 3x4mm TDFN package and is specified for operation over the -40°C to +85°C temperature range.

Features

- Input Supply Voltage Range: 2.7V to 5.5V
- Maximum Boost Output Drive: Up to 24V at 100mA
- Up to 85% Efficient Operation
- Up to 2MHz Switching Frequency with Small Inductor
- User-Programmable Full-Scale LED Current, Up to 30mA
- Two-Wire, I²C Compliant Serial Interface
 - Two Addressable Registers
 - Independent LED Current Control by Group
 - Backlight Group B1-B2, 16 Settings
 - Auxiliary Group A1-A3, 16 Settings
 - Independent LED ON/OFF Control
 - Fast, 400kHz Serial Transfer Rate
- Non-Pulsating, High-Performance LED Current Drive for Uniform Illumination
 - 10% Absolute Accuracy
 - 2% Channel-to-Channel Matching
- Over-Voltage and Over-Temperature Protection
- Automatic Soft-Start Minimizes Large Inrush Current at Startup
- Available in 3x4mm TDFN34-16 Package

Applications

- Digital Still Cameras (DSCs)
- Keypad Backlight
- Large Panel Displays
- Mobile Handsets
- PDAs and Notebook PCs
- Personal Media Players
- White LED Backlight

Typical Application

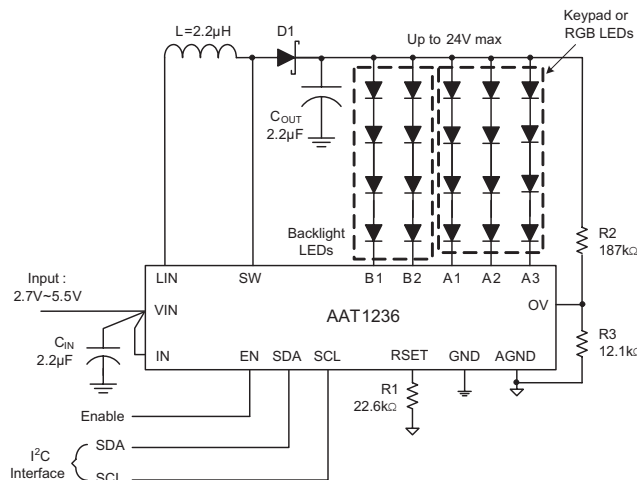

High Efficiency White LED Drivers for Backlight and Keypad**Pin Descriptions**

Pin #	Symbol	Function
1	VIN	Input supply for the converter. Connect a 2.2 μ F or larger ceramic capacitor from VIN to GND.
2	OV	Boost output over voltage detect pin. Use resistor divider to set the circuit's external over-voltage protection. See Applications Information for details.
3	EN	Enable pin.
4	B1	Backlight current sink 1. Connect the cathode of the last LED in the string to B1.
5	B2	Backlight current sink 2. Connect the cathode of the last LED in the string to B2.
6	RSET	LED current set resistor. A 22.6k Ω resistor from RSET to AGND sets the maximum LED current in A1-A3 and B1-B2 to 20mA.
7	IN	Input bias supply for the internal circuitry. Connect IN to VIN directly at the AAT1236.
8	GND	Power ground for the boost converter. Connect GND to AGND at a single point as close to the AAT1236 as practical.
9	SW	Boost converter switching node. A 2.2 μ H inductor, connected between SW and LIN, sets the boost converter's switching frequency.
10	SDA	I ² C interface serial data line.
11	SCL	I ² C interface serial clock line.
12	AGND	Ground pin. Connect AGND to GND at a single point as close to the AAT1236 as practical.
13	A3	Auxiliary current sink 3. Connect the cathode of the last LED in the string to A3.
14	A2	Auxiliary current sink 2. Connect the cathode of the last LED in the string to A2.
15	A1	Auxiliary current sink 1. Connect the cathode of the last LED in the string to A1.
16	LIN	Switched power input. Connect LIN to the external power inductor.
EP		Exposed paddle (bottom). Connected internally to SW. Connect to SW or leave floating.

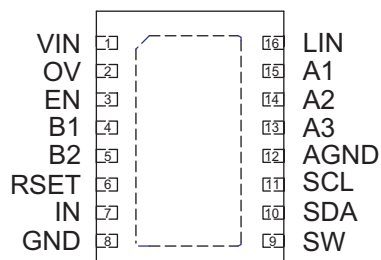
Pin Configuration**TDFN34-16
(Top View)**

High Efficiency White LED Drivers for Backlight and Keypad

Absolute Maximum Ratings¹

$T_A = 25^\circ\text{C}$ unless otherwise noted.

Symbol	Description	Value	Units
V _{IN} , I _N	Input Voltage	-0.3 to 6.0	V
SW	Switching Node	28	V
EN, SCL, SDA, B _x , Ax, RSET, OV, LIN	Maximum Rating	V _{IN} + 0.3	V
T _S	Storage Temperature Range	-65 to 150	°C
T _J	Operating Temperature Range	-40 to 150	°C
T _{LEAD}	Maximum Soldering Temperature (at leads, 10 sec)	300	°C

Thermal Information²

Symbol	Description	Value	Units
θ_{JA}	Thermal Resistance	50	°C/W
P _D	Maximum Power Dissipation ³	2	W

1. Stresses above those listed in Absolute Maximum Ratings may cause permanent damage to the device. Functional operation at conditions other than the operating conditions specified is not implied. Only one Absolute Maximum Rating should be applied at any one time.
 2. Mounted on an FR4 circuit board.
 3. Derate 20mW/°C above 40°C ambient temperature.

High Efficiency White LED Drivers for Backlight and Keypad

Electrical Characteristics¹

$V_{IN} = 3.6V$; $C_{IN} = 2.2\mu F$; $T_A = -40^{\circ}C$ to $+85^{\circ}C$, unless otherwise noted. Typical values are at $T_A = 25^{\circ}C$.

Symbol	Description	Conditions	Min	Typ	Max	Units
Power Supply						
V_{IN}	Input Voltage Range		2.7		5.5	V
$V_{OUT(MAX)}$	Maximum Output Voltage				24	V
V_{UVLO}	UVLO Threshold	V_{IN} Rising			2.7	V
		Hysteresis		150		mV
		V_{IN} Falling	1.8			V
I_{CC}	Operating Current (No Switching)	$B1 = B2 = A1 = A2 = A3 = 1.2V$, 2mA Setting, $R_{SET} = 226k\Omega$			300	μA
$I_{SHDN(MAX)}$	VIN Pin Shutdown Current	EN = GND			1.0	μA
I_{OX}	Maximum Continuous Output Current	$V_O = 24V$	100			mA
I_{DX}	Current Sink Accuracy	$R_{SET} = 22.6k\Omega$	18	20	22	mA
$I_{DX-Matching}$	Current Matching Between Any Sink Channels	$R_{SET} = 22.6k\Omega$, $A1 = A2 = A3 = B1 = B2 = 0.4V$		2	5	%
V_{OV}	OVP Threshold Voltage	V_{OUT} Rising	1.1	1.2	1.3	V
	OVP Threshold Hysteresis			100		mV
$R_{DS(ON)N}$	Low Side Switch On Resistance	$I_{OUT} = 100mA$		80		$m\Omega$
$R_{DS(ON)IN}$	Input Disconnect Switch	$I_{OUT} = 100mA$		200		$m\Omega$
T_{SS}	Soft-Start Time	From Enable to Output Regulation; $V_{FB} = 300mV$		300		μs
I_{SET}	Current Set Ratio	I_{SINK}/I_{RSET} , $V_{RSET} = 0.6V$		760		A/A
I_{LIMIT}	Input Switch Current Limit		1.2			A
Enable Input – EN						
$V_{EN(L)}$	Enable Threshold Low				0.4	V
$V_{EN(H)}$	Enable Threshold High		1.4			V
I²C Serial Interface – SCL, SDA						
F_{SCL}	Clock Frequency				400	kHz
T_{LOW}	Clock Low Period		1.3			μs
T_{HIGH}	Clock High Period		0.6			μs
T_{HD_STA}	Hold Time START Condition		0.6			μs
T_{SU_STA}	Setup Time for Repeat START		0.6			μs
T_{SU_DAT}	Data Setup Time		100			ns
T_{HD_DAT}	Data Hold Low		0		0.9	μs
T_{SU_STO}	Setup Time for STOP Condition		0.6			μs
T_{BUF}	Bus Free Time Between STOP and START Condition		1.3			μs
V_{IL}	Input Threshold Low	$2.7 \leq V_{IN} \leq 5.5$			0.4	V
V_{IH}	Input Threshold High	$2.7 \leq V_{IN} \leq 5.5$	1.4			V
I_I	Input Current		-1.0		1.0	μA
V_{OL}	Output Logic Low (SDA)	$I_{PULLUP} = 3mA$			0.4	V
Thermal Protection						
T_{J-TH}	T_J Thermal Shutdown Threshold			140		$^{\circ}C$
T_{J-HYS}	T_J Thermal Shutdown Hysteresis			15		$^{\circ}C$

1. The AAT1236 is guaranteed to meet performance specifications over the $-40^{\circ}C$ to $+85^{\circ}C$ operating temperature range and is assured by design, characterization, and correlation with statistical process controls.

High Efficiency White LED Drivers for Backlight and Keypad

I²C Interface Timing Details

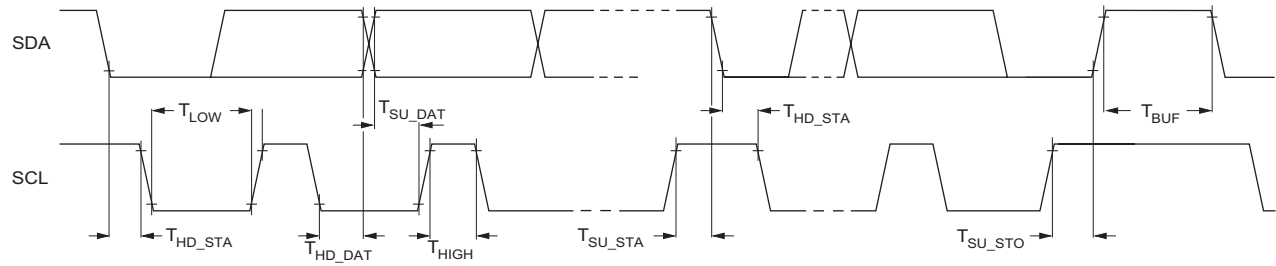

High Efficiency White LED Drivers for Backlight and Keypad

Typical Characteristics

Efficiency vs. LED Current
(Group B On; Group A Off)

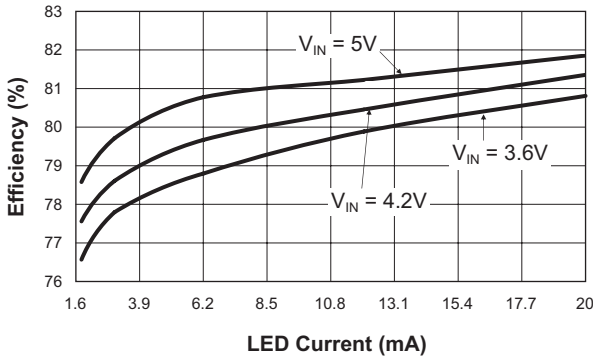

Efficiency vs. LED Current
(Group B Off; Group A On)

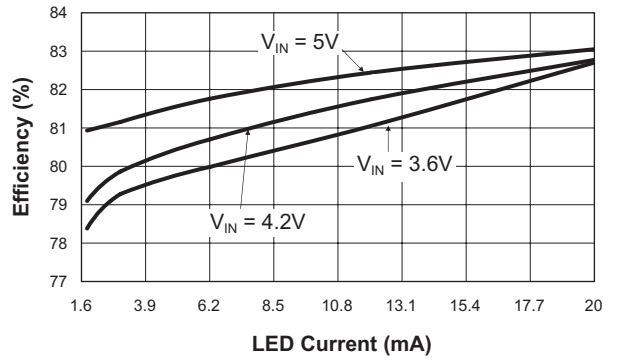

Efficiency vs. LED Current
(Group A and B On)

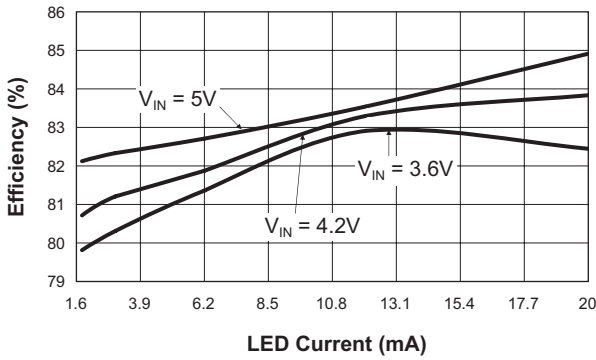

LED Current Accuracy vs. Supply Voltage

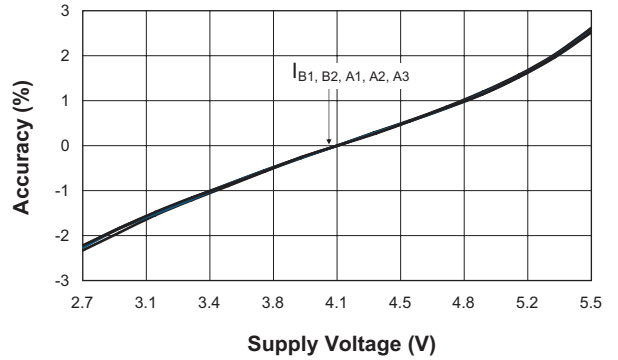

LED Current vs. Supply Voltage

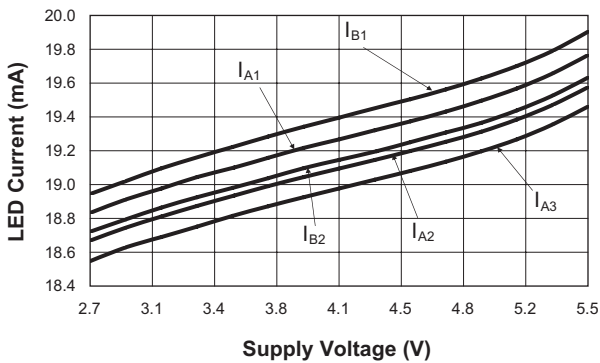

Shutdown Current vs. Supply Voltage and Temperature

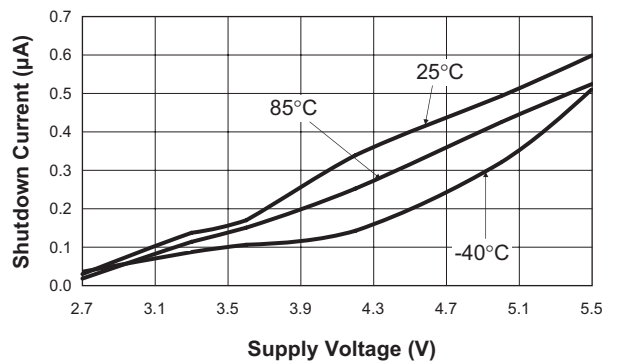

AAT1236

High Efficiency White LED Drivers for Backlight and Keypad

Typical Characteristics

LED Current vs. Temperature
(All Channels = 20mA)

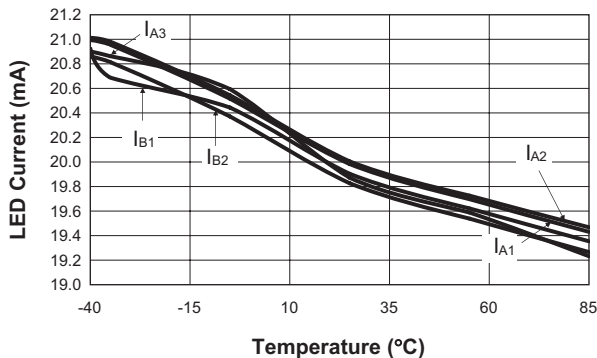

LED Current Accuracy vs. Temperature
(All Channels = 20mA)

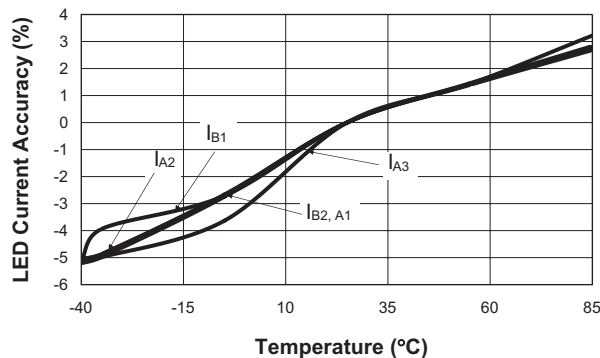

Shutdown Operation
(All Channels)

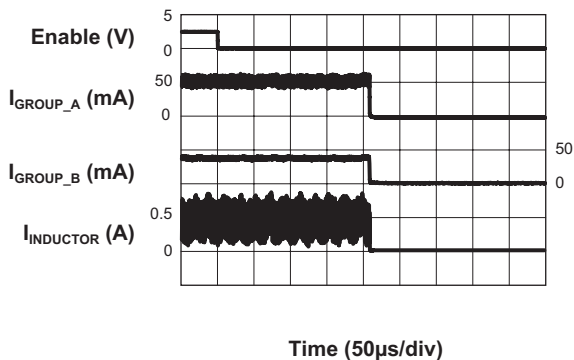

Output Ripple
(All Channels = 20mA)

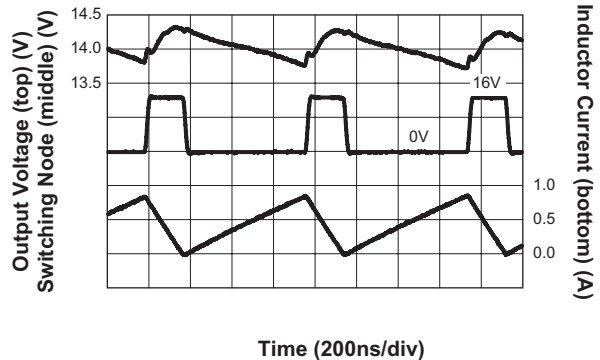

Output Ripple
(All Channels = 10mA)

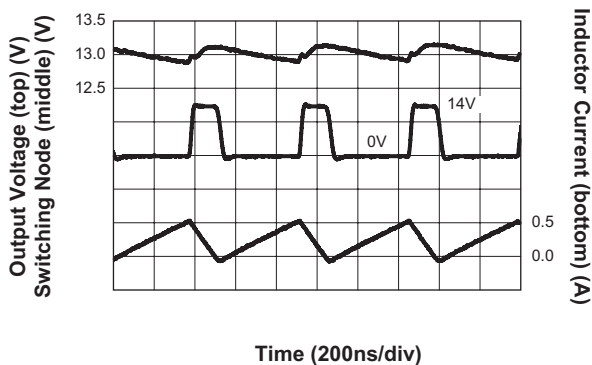

Switching Frequency vs. Supply Voltage and Temperature

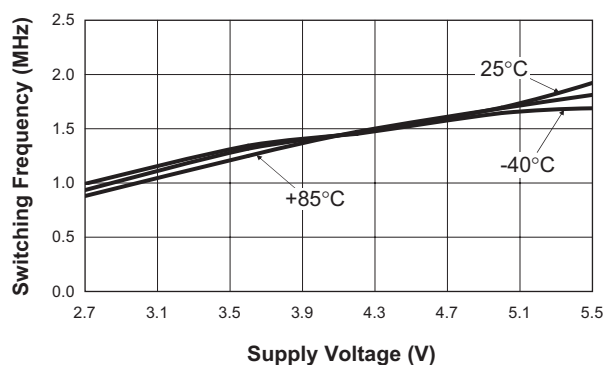

High Efficiency White LED Drivers for Backlight and Keypad

Typical Characteristics

Line Transient
(All Channels = 20mA)

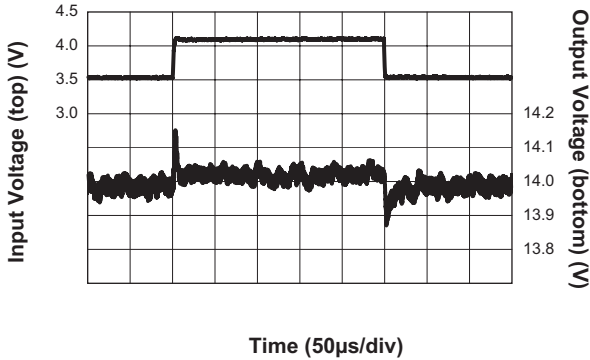

Enable Threshold Low vs. Supply Voltage and Temperature

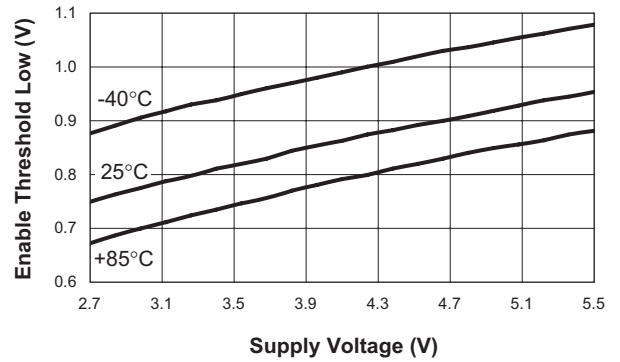

Enable Threshold High vs. Supply Voltage and Temperature

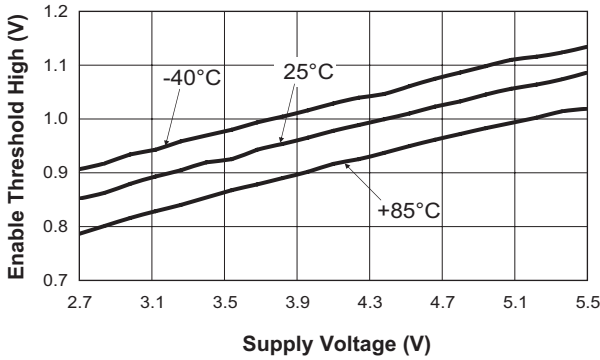

Input Disconnect Switch Resistance vs. Supply Voltage and Temperature

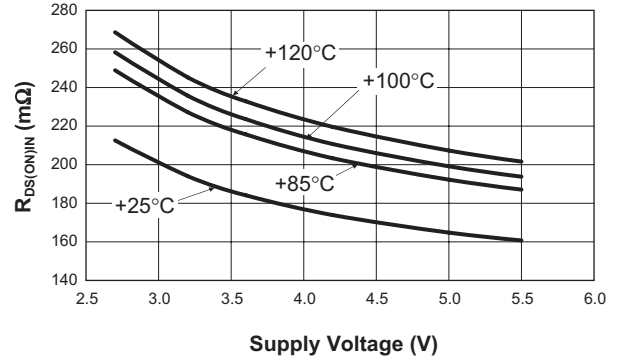

Low Side Switch On Resistance vs. Supply Voltage and Temperature

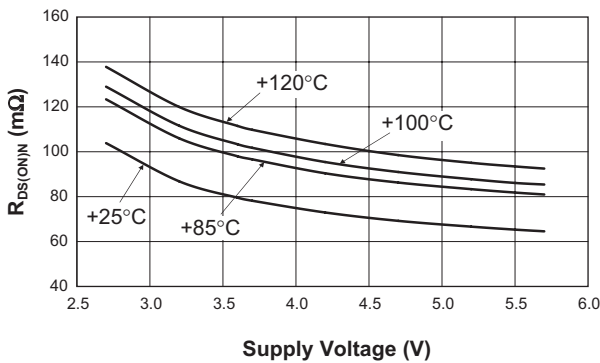

Soft Start Operation
(All Channels = 20mA)

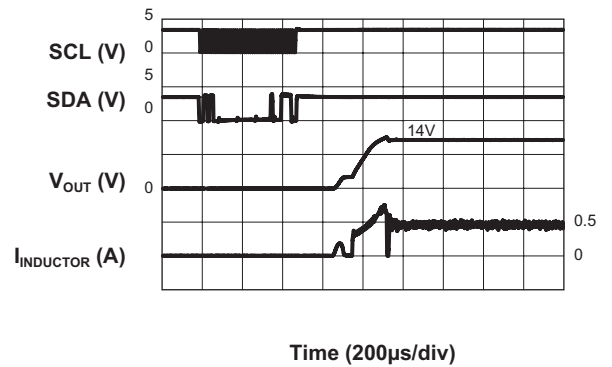

High Efficiency White LED Drivers for Backlight and Keypad

Typical Characteristics

Transition of LED Current
(All Channels = 20mA to 1.8mA)

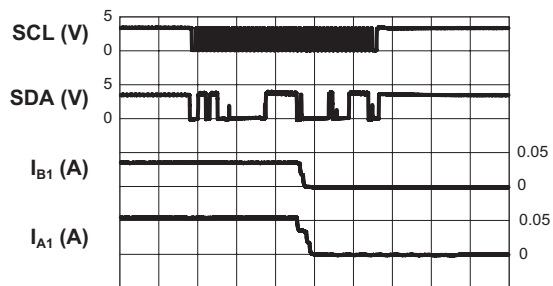

Time (100µs/div)

Transition of LED Current
(Group A= 20mA to 1.8mA; Group B = 20mA)

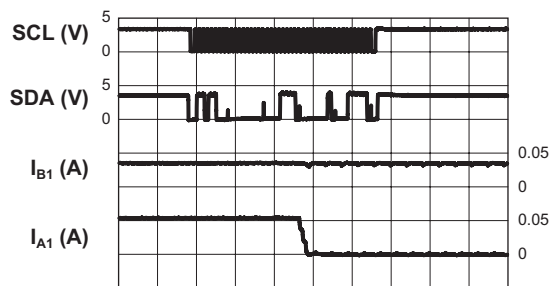

Time (100µs/div)

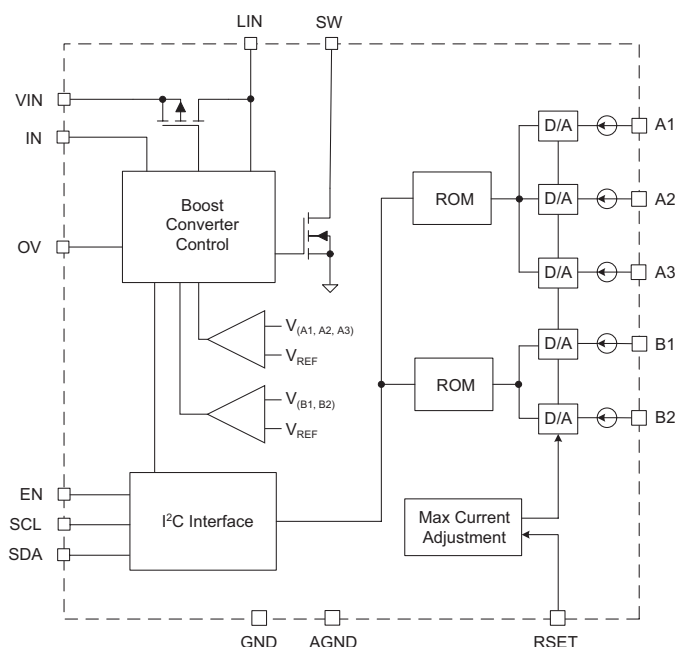
High Efficiency White LED Drivers for Backlight and Keypad**Functional Block Diagram****Functional Description**

The AAT1236 consists of a controller for the step-up switching converter and its power switch, and five regulated current sinks programmable over 16 levels into two groups, which can be turned on/off individually. An external Schottky diode, a power inductor, an output capacitor, and a resistor divider are required to complete the solution.

The AAT1236's boost controller is designed to deliver 100mA up to 24V. The AAT1236 is capable of driving a total of five channels divided into two groups with four white LEDs connected in series at each channel.

The output load current can be programmed by the current sink magnitudes. I²C interface programming allows independent control of two groups of current sinks (A1 to A3 and B1 to B2) and control on/off with a different configuration on each channel. Unused sink channel(s) must be connected to AGND to ensure proper function of the AAT1236.

Control Loop

The AAT1236 provides the benefits of current mode control with a simple hysteretic output current loop providing exceptional stability and fast response with minimal design effort. The device maintains exceptional constant current regulation, transient response, and cycle-by-

cycle current limit without additional compensation components.

The AAT1236 modulates the power MOSFET switching current to maintain the programmed sink current through each channel. The sink voltage at each channel is monitored and the controller provides direct feedback in order to maintain the desired LED currents.

The switching cycle initiates when the N-channel MOSFET is turned ON and current ramps up in the inductor. The ON interval is terminated when the inductor current reaches the programmed peak current level. During the OFF interval, the input current decays until the lower threshold, or zero inductor current, is reached. The lower current is equal to the peak current minus a preset hysteresis threshold, which determines the inductor ripple current. Peak current is adjusted by the controller until the desired LED output current level is met.

The magnitude of the feedback error signal determines the average input current. Therefore, the AAT1236 controller implements a programmed current source connected to the output capacitor, parallel with the LED channels. There is no right-half plane zero, and loop stability is achieved with no additional compensation components. The controller responds by increasing the peak inductor current, resulting in higher average current in the inductor and LED channels.

High Efficiency White LED Drivers for Backlight and Keypad

Under light load conditions, the inductor OFF interval current goes below zero and the boost converter enters discontinuous mode operation. Further reduction in the load current results in a corresponding reduction in the switching frequency. The AAT1236 provides pulsed frequency operation which reduces switching losses and maintains high efficiency under light load conditions.

Operating frequency varies with changes in the input voltage, output voltage, and inductor size. Once the boost converter has reached continuous mode, further increases in the LED current will not significantly change the operating frequency. A small 2.2 μ H ($\pm 20\%$) inductor is selected to maintain high frequency switching (up to 2MHz) and high efficiency operation for outputs up to 24V.

Soft Start / Enable

The input disconnect switch is activated when a valid supply voltage is present and the EN/SET pin is strobed high. Slew rate control on the input disconnect switch ensures minimal inrush current as the output voltage is charged to the input voltage, prior to switching of the N-channel power MOSFET. A monotonic turn-on is guaranteed by the built-in soft-start circuitry, which eliminates output current overshoot across the full input voltage range and over all load conditions.

Current Limit and Over-Temperature Protection

The switching of the N-channel MOSFET terminates when a current limit of 1.5A (typical) is exceeded. This minimizes power dissipation and component stresses under overload and short-circuit conditions. Switching resumes when the current decays below the current limit.

Thermal protection disables the AAT1236 when internal power dissipation becomes excessive, as it disables both MOSFETs. The junction over-temperature threshold is 140°C with 15°C of temperature hysteresis. The output voltage automatically recovers when the over-temperature fault condition is removed.

Over-Voltage Protection

Over-voltage protection prevents damage to the AAT1236 during open-circuit on any LED channel causing high output voltage conditions. An over-voltage event is defined as a condition where the voltage on the OV pin exceeds the over-voltage threshold limit ($V_{OV} = 1.2V$ typical). When the voltage on the OV pin has reached

the threshold limit, the converter stops switching and the output voltage decays. Switching resumes when the voltage on the OV pin drops below the lower hysteresis limit, maintaining an average output voltage between the upper and lower OV thresholds multiplied by the resistor divider scaling factor.

Under-Voltage Lockout

Internal bias of all circuits is controlled via the V_{IN} input. Under-voltage lockout (UVLO) guarantees sufficient V_{IN} bias and proper operation of all internal circuitry prior to soft start.

I²C Serial Interface and Programmability

The current sink magnitude of each group and the on/off status of each channel is controlled via an I²C serial interface. I²C is a widely used interface which requires a master to initiate all the communications with the device. I²C protocol consists of two active wire SDA (serial data line) and SCL (serial clock line). Both wires are open drain and require an external pull-up resistor to V_{CC} . The SDA pin serves the I/O function, and the SCL pin controls and references the I²C bus. The I²C protocol is a bidirectional bus which allows both read and write actions to take place; the AAT1236 supports the write protocol only. Since the protocol has a dedicated bit for Read or Write (R/W), when communicating with the AAT1236, this bit must be set to "0."

I²C Programming Register Address and Register Data

After sending the device address, the I²C master should send an 8-bit register address and 8-bit data for programming. The AAT1236 has two registers; the Brightness Control Register determines the percentage of the maximum current set by R_{SET} applied to each channel and the Channel Control Register determines which channels are enabled or disabled. The programming is as follows:

BR_CTRL – LED Brightness Control Register (Address: 00h)

BR_CTRL	D7	D6	D5	D4	D3	D2	D1	D0
Bit name	BX3	BX2	BX1	BX0	AX3	AX2	AX1	AX0

Control register BR_CTRL can be used to control LED brightness for each group. Control bits BX3, BX2, BX1, BX0 set the percentage of the maximum LED level in Group B. Control bits AX3, AX2, AX1, AX0 set the percentage of the maximum LED level in Group A.

High Efficiency White LED Drivers for Backlight and Keypad

BR_CTRL [BX3:BX0], [AX3:AX0]	All Outputs (%)
0000	100
0001	84
0010	71
0011	60
0100	51
0101	43
0110	35
0111	31
1000	26
1001	21
1010	18
1011	15
1100	13.5
1101	12.0
1110	10.5
1111	9.0

Table 1: LED Current Setting as Percentage of the Maximum Level Set by R_{SET}.

CH_CTRL – Channel ON/OFF Control Register (Address: 01h)

CH_CTRL	D7	D6	D5	D4	D3	D2	D1	D0
Bit name	–	–	–	BY1	BY2	AY1	AY2	AY3

Control register CH_CTRL can be used to disable (OFF) or enable (ON) individual channels.

CH_CTRL [BY1:BY2]	B1	B2
00	OFF	OFF
01	OFF	ON
10	ON	OFF
11	ON	ON

CH_CTRL [AY1:AY3]	A1	A2	A3
000	OFF	OFF	OFF
001	OFF	OFF	ON
010	OFF	ON	OFF
011	OFF	ON	ON
100	ON	OFF	OFF
101	ON	OFF	ON
110	ON	ON	OFF
111	ON	ON	ON

Application Information

I²C Serial Interface

The AAT1236 is fully compliant with the industry-standard I²C interface. The I²C two-wire communications bus consists of SDA and SCL lines. SDA provides data, while SCL provides clock synchronization. SDA data transfers device address followed by a register address and data bits sequence. When using the I²C interface, EN/SET is pulled high to enable the device or low to disable the device. The I²C serial interface requires a master to initiate all the communications with target devices. The AAT1236 is a target device and only supports the write protocol. The AAT1236 is manufactured with a target device address of 0x36 (Hex). See Figure 1 for the I²C interface diagram.

I²C START and STOP Conditions

START and STOP conditions are always generated by the master. Prior to initiating a START, both the SDA and SCL pins are in idle mode (idle mode is when there is no activity on the bus and both SDA and SCL are pulled high by the external pull-up resistors). A START condition occurs when the master pulls the SDA line low and, after a short period, pulls the SCL line low. A START condition acts as a signal to all ICs that transmission activity is about to occur on the BUS. A STOP condition, as shown in Figure 2, is when the master releases the bus and SCL changes from low to high followed by SDA low-to-high transition.

I²C Address Bit Map

Figure 3 illustrates the address bit transfer. The 7-bit address is transferred with the Most Significant Bit (MSB) first and is valid when SCL is high. This is followed by the R/W bit in the Least Significant Bit (LSB) location. The R/W bit determines the direction of the transfer ('1' for read, '0' for write). The AAT1236 is a write-only device and this bit must be set low. The Acknowledge bit (ACK) is set to low by the AAT1236 to acknowledge receipt of the address.

I²C Register Address / Data Bit Map

Figure 4 illustrates the Register Address or the data bit transfer. The 8-bit data is always transferred with the most significant bit first and is valid when SCL is high. The Acknowledge bit (ACK) is set low by the AAT1236 to acknowledge receipt of the register address or the data.

AAT1236

High Efficiency White LED Drivers for Backlight and Keypad

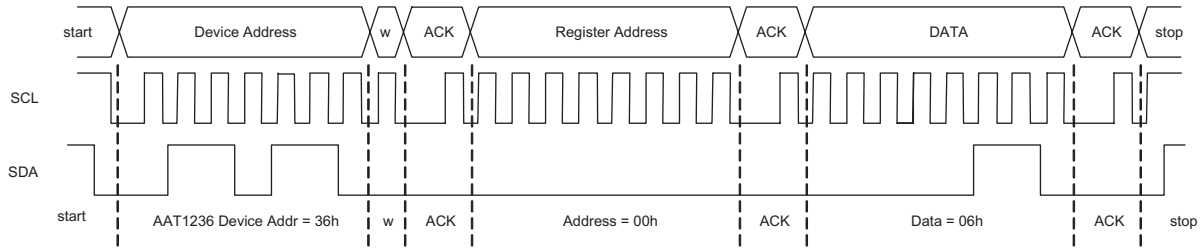

Figure 1: I²C Serial Interface Diagram.

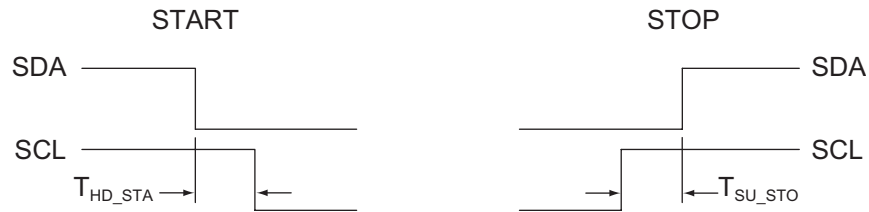

Figure 2: I²C Start and Stop Conditions;
START: A High "1" to Low "0" Transition on the SDA Line While SCL is High "1"
STOP: A Low "0" to High "1" Transition on the SDA Line While SCL is High "1."

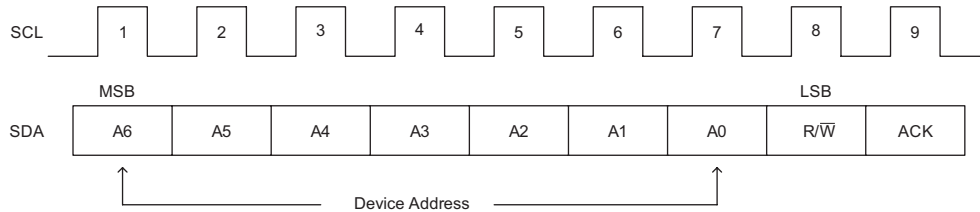

Figure 3: I²C Device Address Bit;
7-bit Slave Address (A6-A0), 1-bit Read/Write (R/W), 1-bit Acknowledge (ACK).

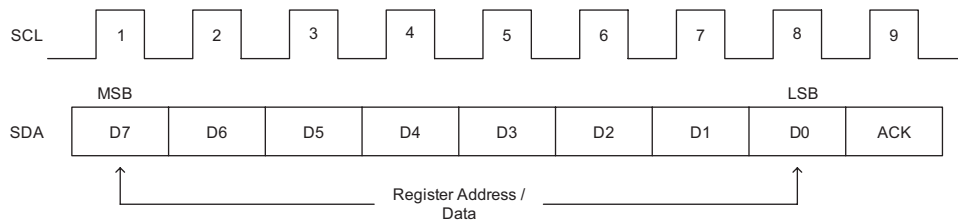

Figure 4: I²C Register Address and Data Bit Map;
8-bit Data (D7-D0), 1-bit Acknowledge (ACK).

AAT1236

High Efficiency White LED Drivers for Backlight and Keypad

I²C Acknowledge Bit (ACK)

The Acknowledge bit is the ninth bit of each transfer on the SDA line. It is used to send back a confirmation to the master that the data has been received properly by the target device. For each ACK to take place, the master must first release the SDA line, then the target device will pull the SDA line low, as shown in Figures 1, 3 and 4.

I²C Software Protocol Example

The AAT1236 I²C programming protocol is shown in the following two examples, detailing the device address, register address and data bits. Figure 5 shows the I²C transfer protocol.

Example 1:

Turn on Group A with 15% from the max current setting and turn on Group B with 51% from the max current setting.

1. Send a start condition
2. Send the AAT1236's I²C device address (0x36) with the R/W bit set low
3. Wait for the acknowledge (ACK) bit within the clock cycle
4. Send the BR_CTRL register address (0x00)
5. Wait for the ACK bit within the clock cycle
6. Send the BR_CTRL Data (0x4B)
7. Wait for the ACK bit within the clock cycle

8. Send the CH_CTRL register address (0x01)
9. Wait for the ACK bit within the clock cycle
10. Send the CH_CTRL Data (0x1F)
11. Wait for the ACK bit within the clock cycle
12. Send the stop condition

Example 2:

Turn on A1 and A3 with 43% for the max LED current setting and turn on Group B with 100% for the max LED current setting. Figure 6 shows the I²C transfer protocol.

1. Send a start condition
2. Send the AAT1236's I²C device address (0x36) with the R/W bit set low
3. Wait for the acknowledge (ACK) bit within the clock cycle
4. Send the BR_CTRL register address (0x00)
5. Wait for the ACK bit within the clock cycle
6. Send the BR_CTRL Data (0x05)
7. Wait for the ACK bit within the clock cycle
8. Send the CH_CTRL register address (0x01)
9. Wait for the ACK bit within the clock cycle
10. Send the CH_CTRL Data (0x1D)
11. Wait for the ACK bit within the clock cycle
12. Send the stop condition

Channel Disable

Tie all unused channels to AGND. On start-up these channels will be automatically disabled.

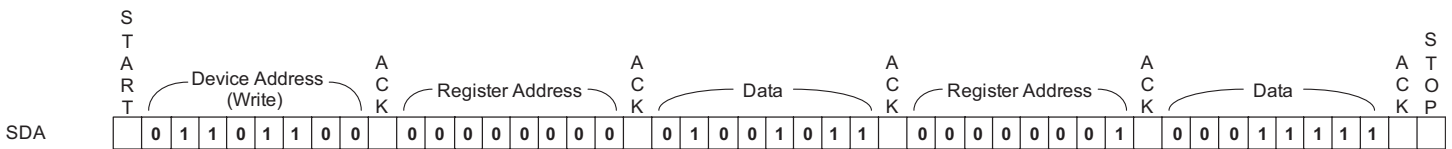

Figure 5: I²C Transfer Protocol for Example 1.

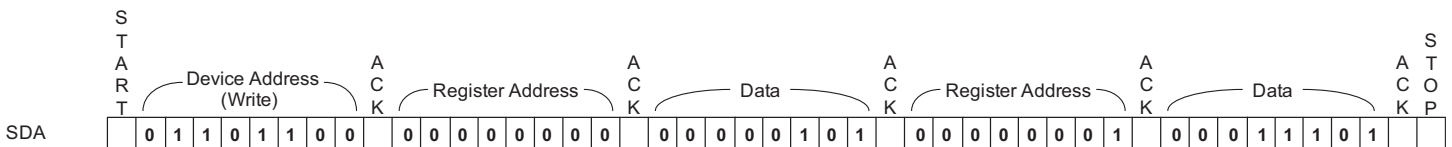

Figure 6: I²C Transfer Protocol for Example 2.

AAT1236

High Efficiency White LED Drivers for Backlight and Keypad

LED Selection

Although the AAT1236 is specifically designed to drive white LEDs, the device can also be used to drive most types of LEDs with forward voltages ranging between 2.0V and 4.7V. Since the A1, A2, A3, and B1, B2 input current sinks are matched with low voltage dependence, the LED-to-LED brightness will be matched regardless of the individual LED forward voltage (V_F) levels. In some instances, it may be necessary to drive high- V_F type LEDs. The low dropout ($\sim 0.1V$ @ $20mA$ I_{LED}) current sinks in the AAT1236 make it capable of driving LEDs with forward voltages as high as 4.7V from an input supply as low as 3.0V. LED outputs A1-A3 and B1-B2 can be combined to drive high-current LEDs without complication, making the AAT1236 a perfect application for large LCD display backlighting and keypad LED applications.

Constant Current Setting

The LED current is controlled by the R_{SET} resistor. For maximum accuracy, a 1% tolerance resistor is recommended. Table 2 shows the R_{SET} resistor value for AAT1236 for various LED full-scale current levels.

I_{LED} (mA)	R_{SET} (k Ω)
30	14.7
25	17.4
20	22.6
15	29.4
10	44.2
5	93.1

Table 2: Maximum LED Current and R_{SET} Resistor Values (1% Resistor Tolerance).

Maximum LED current per channel versus R_{SET} value is shown in Figure 7.

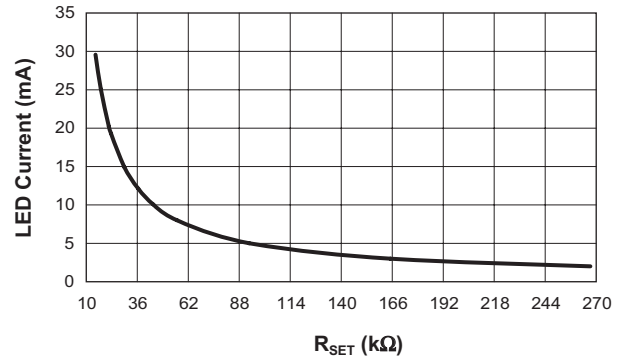

Figure 7: LED Current vs. R_{SET} Values.

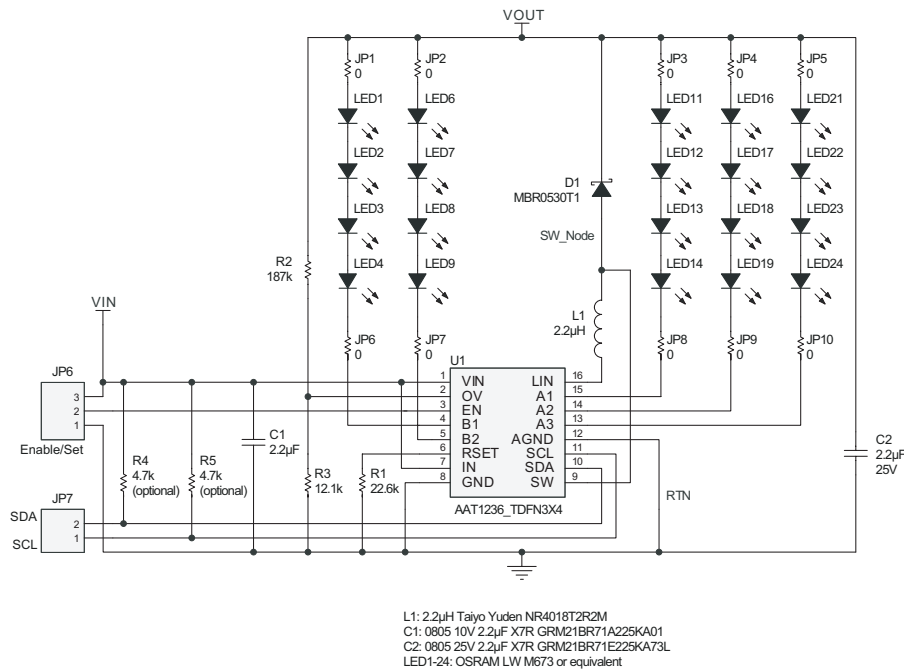

Figure 8: A AAT1236-based High Efficiency White LED Driver Schematic.

High Efficiency White LED Drivers for Backlight and Keypad

Over-Voltage Protection

The over-voltage protection circuit consists of a resistor network connected from the output voltage to the OV pin (see Figure 9). This over voltage protection circuit prevents damage to the device when one of the five channels has an open LED circuit. The AAT1236 continues to operate; however, the LED current in the remaining channels is no longer regulated and the actual LED current will be determined by the externally programmed over-voltage protection threshold, the inductor value, and the switching frequency.

The resistor divider can be selected such that the over-voltage threshold occurs prior to the output reaching 24V ($V_{OUT(MAX)}$). The value of R3 should be selected from 10k Ω to 20k Ω to minimize switching losses without degrading noise immunity.

$$R_2 = R_3 \cdot \frac{V_{OUT(PROTECTION)}}{V_{OV}} - 1$$

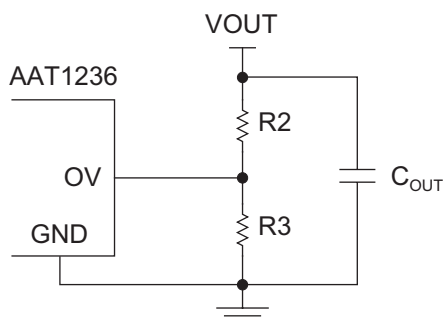

Figure 9: Over-Voltage Protection Circuit.

If four LEDs are connected in series on one channel, the total V_F from the WLEDs could be as high as 18.8V. Therefore, using $R_3 = 12.1k\Omega$ and setting $V_{OUT(PROTECTION)} = 20V$ is recommended. Selecting a 1% resistor, this results in $R_2 = 187k\Omega$ (rounded to the nearest standard 1% value).

It is always recommended to use the same number of WLEDs on each channel and set the appropriate over-voltage protection. Failure to do so may cause any one of the (5) sink pins to exceed the absolute maximum

rating voltage and permanently damage the device in case the channel is disconnected (open circuit failure). Examples of over voltage settings for various strings of series-connected LEDs are shown in Table 3.

Number of WLEDs on Each Channel	Total Maximum V_F (V)	$V_{OUT(PROTECTION)}$ (V)	$R_3 = 12.1k\Omega$ R_2 (k Ω)
4	18.8	20	187
3	14.1	15	140
2	9.4	10	88.7

Table 3: Over-Voltage Protection Settings.

LED Brightness Control

The AAT1236 uses the I²C interface to program and control LED brightness. The output current of the AAT1236 can be changed successively to brighten or dim the LEDs in smooth transitions (i.e., to fade in or fade out) or in discrete steps, giving the user complete programmability and real-time control of LED brightness.

Selecting the Schottky Diode

To ensure minimum forward voltage drop and no recovery, high voltage Schottky diodes are recommended for the AAT1236 boost converter. The output diode is selected to maintain acceptable efficiency and reasonable operating junction temperature under full load operating conditions. Forward voltage (V_F) and package thermal resistance (θ_{JA}) are the dominant factors in selecting a diode. The diode non-repetitive peak forward surge current rating (I_{FSM}) should be considered for high pulsed load applications, such as camera flash. I_{FSM} rating drops with increasing conduction period. Manufacturers' datasheets should be reviewed carefully to verify reliability under peak loading conditions. The diode's published current rating may not reflect actual operating conditions and should be used only as a comparative measure between similarly rated devices.

20V rated Schottky diodes are recommended for output voltages less than 15V, while 30V rated Schottky diodes are recommended for output voltages higher than 15V.

High Efficiency White LED Drivers for Backlight and Keypad

Estimating Schottky Diode Power Dissipation

The switching period is divided between ON and OFF time intervals:

$$\frac{1}{F_S} = T_{ON} + T_{OFF}$$

During the ON time, the N-channel power MOSFET is conducting and storing energy in the boost inductor. During the OFF time, the N-channel power MOSFET is not conducting. Stored energy is transferred from the input battery and boost inductor to the output load through the output diode.

Duty cycle is defined as the ON time divided by the total switching interval:

$$D = \frac{T_{ON}}{T_{ON} + T_{OFF}}$$

$$= T_{ON} \cdot F_S$$

The maximum duty cycle can be estimated from the relationship for a continuous mode boost converter. Maximum duty cycle (D_{MAX}) is the duty cycle at minimum input voltage ($V_{IN(MIN)}$):

$$D_{MAX} = \frac{V_{OUT} - V_{IN(MIN)}}{V_{OUT}}$$

The average diode current during the OFF time can be estimated:

$$I_{AVG(OFF)} = \frac{I_{OUT}}{1 - D_{MAX}}$$

The V_F of the Schottky diode can be estimated from the average current during the off time. The average diode current is equal to the output current:

$$I_{AVG(TOT)} = I_{OUT}$$

The average output current multiplied by the forward diode voltage determines the loss of the output diode:

$$P_{LOSS(DIODE)} = I_{AVG(TOT)} \cdot V_F$$

$$= I_{OUT} \cdot V_F$$

For continuous LED currents, the diode junction temperature can then be estimated:

$$T_{J(DIODE)} = T_{AMB} + \theta_{JA} \cdot P_{LOSS(DIODE)}$$

External Schottky diode junction temperature should be below 110°C, and may vary depending on application and/or system guidelines. The diode θ_{JA} can be minimized with additional metal PCB area on the cathode. However, adding additional heat-sinking metal around the anode may degrade EMI performance. The reverse leakage current of the rectifier must be considered to maintain low quiescent (input) current and high efficiency under light load. The rectifier reverse current increases dramatically at elevated temperatures.

Selecting the Boost Inductor

The AAT1236 controllers utilize hysteretic control and the switching frequency varies with output load and input voltage. The value of the inductor determines the maximum switching frequency of the boost converter. Increased output inductance decreases the switching frequency, resulting in higher peak currents and increased output voltage ripple. To maintain 2MHz maximum switching frequency and stable operation, an output inductor selected between 1.5µH and 2.7µH is recommended.

Manufacturer	Part Number	Rated $I_{F(AV)}$ Current (A)	Rated Voltage (V)	Thermal Resistance (θ_{JA} , °C/W)	Case
Diodes, Inc.	B0520WS	0.50	20	426	SOD-323
ON Semi	MBR130LSFT	1.00	30	325	SOD-123
ON Semi	MBR0530T	0.50	30	206	SOD-123

Table 4: Typical Surface Mount Schottky Rectifiers for Various Output Loads (select $T_j < 110^\circ\text{C}$ in application circuit).

High Efficiency White LED Drivers for Backlight and Keypad

A better estimate of D_{MAX} is possible once V_F is known:

$$D_{MAX} = \frac{(V_{OUT} + V_F - V_{IN(MIN)})}{(V_{OUT} + V_F)}$$

Where V_F is the Schottky diode forward voltage. If not known or not provided by the manufacturer, a starting value of 0.5V can be used.

Manufacturer's specifications list both the inductor DC current rating, which is a thermal limitation, and peak inductor current rating, which is determined by the saturation characteristics. Measurements at full load and high ambient temperature should be performed to ensure that the inductor does not saturate or exhibit excessive temperature rise.

The output inductor (L) is selected to avoid saturation at minimum input voltage and maximum output load conditions. Peak current may be estimated using the following equation, assuming continuous conduction mode. Worst-case peak current occurs at minimum input voltage (maximum duty cycle) and maximum load. Switching frequency (F_S) can be estimated at 500kHz with a 2.2μH inductor:

$$I_{PEAK} = \frac{I_{OUT}}{(1 - D_{MAX})} + \frac{D_{MAX} \cdot V_{IN(MIN)}}{(2 \cdot F_S \cdot L)}$$

At light load and low output voltage, the controller reduces the operating frequency to maintain maximum operating efficiency. As a result, further reduction in output load does not reduce the peak current. Minimum peak current can be estimated between 0.5A and 0.75A.

At high load and high output voltages, the switching frequency is somewhat diminished, resulting in higher I_{PEAK} . Bench measurements are recommended to confirm actual I_{PEAK} and to ensure that the inductor does not saturate at maximum LED current and minimum input supply voltage.

The RMS current flowing through the boost inductor is equal to the DC plus AC ripple components. Under worst-case RMS conditions, the current waveform is critically continuous. The resulting RMS calculation yields worst-case inductor loss. The RMS current value should be compared against the inductor manufacturer's temperature rise, or thermal derating, guidelines:

$$I_{RMS} = \frac{I_{PEAK}}{\sqrt{3}}$$

For a given inductor type, smaller inductor size leads to an increase in DCR winding resistance and, in most cases, increased thermal impedance. Winding resistance degrades boost converter efficiency and increases the inductor's operating temperature:

$$P_{LOSS(INDUCTOR)} = I_{RMS}^2 \cdot DCR$$

To ensure high reliability, the inductor case temperature should not exceed 100°C. In some cases, PCB heatsinking applied to the LIN node (non-switching) can improve the inductor's thermal capability. However, as in the case of adding extra metal around the Schottky's anode, adding extra PCB metal around the AAT1236's SW pin for heatsinking may degrade EMI performance.

Shielded inductors provide decreased EMI and may be required in noise sensitive applications. Unshielded chip inductors provide significant space savings at a reduced cost compared to shielded (wound and gapped) inductors. In general, chip-type inductors have increased winding resistance (DCR) when compared to shielded, wound varieties.

Selecting the Boost Capacitors

The high output ripple inherent in the boost converter necessitates the use of low impedance output filtering.

Multi-layer ceramic (MLC) capacitors provide small size and adequate capacitance, low parasitic equivalent series resistance (ESR) and equivalent series inductance (ESL), and are well suited for use with the AAT1236 boost regulator. MLC capacitors of type X7R or X5R are recommended to ensure good capacitance stability over the full operating temperature range.

The output capacitor is selected to maintain the output load without significant voltage droop (ΔV_{OUT}) during the power switch ON interval, when the output diode is not conducting. A ceramic output capacitor from 2.2μF to 4.7μF is recommended (see Table 6).

Typically, 25V rated capacitors are required for the 24V maximum boost output. Ceramic capacitors selected as small as 0805 are available which meet these requirements.

MLC capacitors exhibit significant capacitance reduction with applied voltage. Output ripple measurements should confirm that output voltage droop and operating stability are within acceptable limits. Voltage derating can minimize this factor, but results may vary with package size and among specific manufacturers.

High Efficiency White LED Drivers for Backlight and Keypad

Manufacturer	Part Number	Inductance (μH)	Max DC I_{SAT} Current (A)	DCR (Ω)	Size (mm) LxWxH	Type
Sumida	CDRH4D22/HP-2R2	2.2	2.50	35	5.0x5.0x2.4	Shielded
Sumida	CDR4D11/HP-2R4	2.4	1.70	105	4.8x4.8x1.2	Shielded
Sumida	CDRH4D18-2R2	2.2	1.32	75	5.0x5.0x2.0	Shielded
Murata	LQH662N2R2M03	2.2	3.30	19	6.3x6.3x4.7	Shielded
Murata	LQH55DN2R2M03	2.2	3.20	29	5.0x5.7x4.7	Non-Shielded
Taiyo Yuden	NR4018T2R2	2.2	2.70	60	4.0x4.0x1.8	Shielded
Taiyo Yuden	NR3015T2R2	2.2	1.48	60	3.0x3.0x1.5	Shielded
Coiltronics	SD3814-2R2	2.2	1.90	77	3.8x3.8x1.4	Shielded
Coiltronics	SD3114-2R2	2.2	1.48	86	3.1x3.1x1.4	Shielded
Coiltronics	SD3112-2R2	2.2	1.12	140	3.1x3.1x1.2	Shielded

Table 5: Typical Surface Mount Inductors for Various Output Loads (select $I_{\text{PEAK}} < I_{\text{SAT}}$).

Manufacturer	Part Number	Value (μF)	Voltage Rating	Temp Co	Case Size
Murata	GRM188R60J225KE19	2.2	6.3	X5R	0603
Murata	GRM21BR71A225KA01	2.2	10	X7R	0805
Murata	GRM219R61E225KA12	2.2	25	X5R	0805
Murata	GRM21BR71E225KA73L	2.2	25	X7R	0805
Murata	GRM21BR61E475KA12	4.7	25	X5R	0805

Table 6: Recommended Ceramic Capacitors.

Output capacitor size can be estimated at a switching frequency (F_s) of 500kHz (worst case):

$$C_{\text{OUT}} = \frac{I_{\text{OUT}} \cdot D_{\text{MAX}}}{F_s \cdot \Delta V_{\text{OUT}}}$$

To maintain stable operation at full load, the output capacitor should be selected to maintain ΔV_{OUT} between 100mV and 200mV.

The boost converter input current flows during both ON and OFF switching intervals. The input ripple current is less than the output ripple and, as a result, less input capacitance is required.

PCB Layout Guidelines

Boost converter performance can be adversely affected by poor layout. Possible impacts include high input and output voltage ripple, poor EMI performance, and reduced operating efficiency. Every attempt should be made to optimize the layout in order to minimize parasitic PCB effects (stray resistance, capacitance, and inductance)

and EMI coupling from the high frequency SW node. A suggested PCB layout for the AAT1236 boost converter is shown in Figures 10 and 11. The following PCB layout guidelines should be considered:

1. Minimize the distance from Capacitor C1 and C2's negative terminals to the GND pins. This is especially true with output capacitor C2, which conducts high ripple current from the output diode back to the GND pins.
2. Minimize the distance between L1 to D1 and switching pin SW; minimize the size of the PCB area connected to the SW pin.
3. Maintain a ground plane and connect to the IC GND pin(s) as well as the GND connections of C1 and C2.
4. Consider additional PCB metal area on D1's cathode to maximize heatsinking capability. This may be necessary when using a diode with a high VF and/or thermal resistance.
5. Do not connect the exposed paddle (bottom of the die) to either AGND or GND because it is connected internally to SW. Connect the exposed paddle to the SW pin or leave floating.

AAT1236

High Efficiency White LED Drivers for Backlight and Keypad

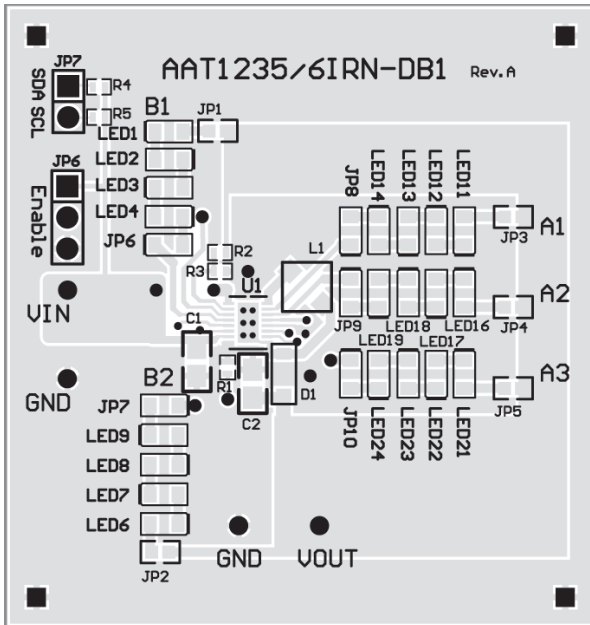

Figure 10: AAT1236 Evaluation Board Top Side Layout.

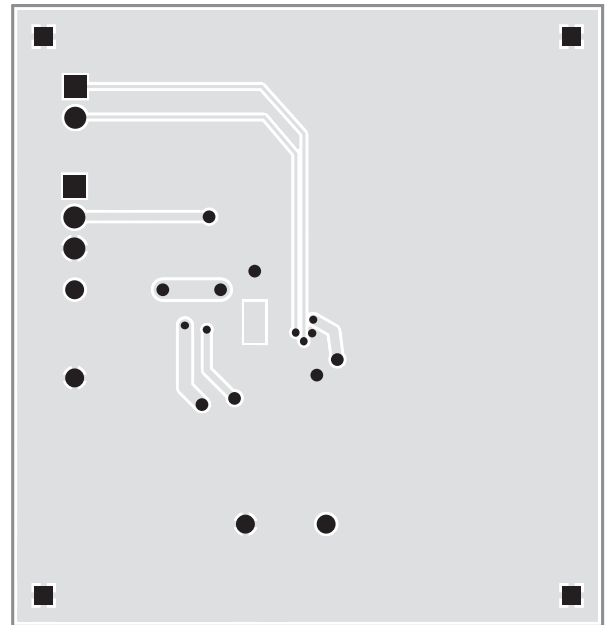

Figure 11: AAT1236 Evaluation Board Bottom Side Layout.

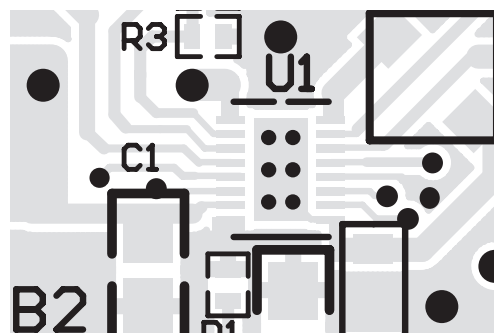

Figure 12: Exploded View of AAT1236 Evaluation Board Top Side Layout Detailing Plated Through Vias.

AAT1236

High Efficiency White LED Drivers for Backlight and Keypad

Ordering Information

Package	Marking ¹	Part Number (Tape and Reel) ²
TDFN34-16	UDXY	AAT1236IRN-T1



Skyworks Green™ products are compliant with all applicable legislation and are halogen-free. For additional information, refer to *Skyworks Definition of Green™*, document number SQ04-0074.

Package Information³

TDFN34-16

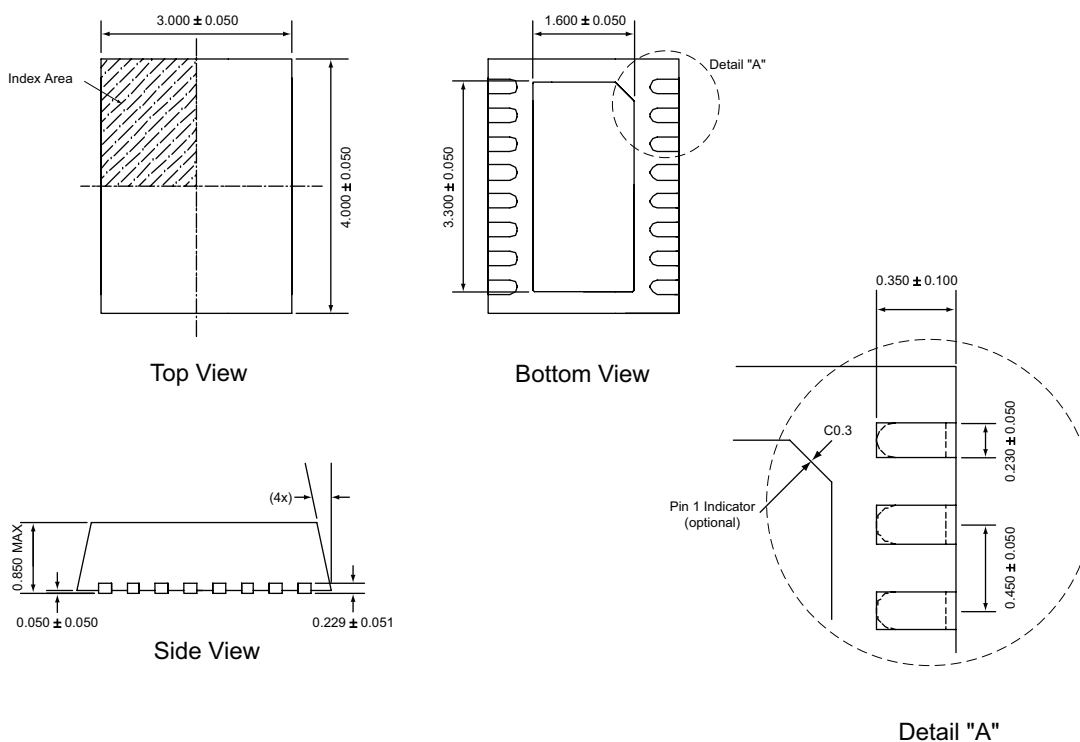

All dimensions in millimeters.

1. XYY = assembly and date code.
 2. Sample stock is generally held on part numbers listed in **BOLD**.
 3. The leadless package family, which includes QFN, TQFN, DFN, TDFN and STDFN, has exposed copper (unplated) at the end of the lead terminals due to the manufacturing process. A solder fillet at the exposed copper edge cannot be guaranteed and is not required to ensure a proper bottom solder connection.

High Efficiency White LED Drivers for Backlight and Keypad

Copyright © 2012 Skyworks Solutions, Inc. All Rights Reserved.

Information in this document is provided in connection with Skyworks Solutions, Inc. ("Skyworks") products or services. These materials, including the information contained herein, are provided by Skyworks as a service to its customers and may be used for informational purposes only by the customer. Skyworks assumes no responsibility for errors or omissions in these materials or the information contained herein. Skyworks may change its documentation, products, services, specifications or product descriptions at any time, without notice. Skyworks makes no commitment to update the materials or information and shall have no responsibility whatsoever for conflicts, incompatibilities, or other difficulties arising from any future changes.

No license, whether express, implied, by estoppel or otherwise, is granted to any intellectual property rights by this document. Skyworks assumes no liability for any materials, products or information provided hereunder, including the sale, distribution, reproduction or use of Skyworks products, information or materials, except as may be provided in Skyworks Terms and Conditions of Sale.

THE MATERIALS, PRODUCTS AND INFORMATION ARE PROVIDED "AS IS" WITHOUT WARRANTY OF ANY KIND, WHETHER EXPRESS, IMPLIED, STATUTORY, OR OTHERWISE, INCLUDING FITNESS FOR A PARTICULAR PURPOSE OR USE, MERCHANTABILITY, PERFORMANCE, QUALITY OR NON-INFRINGEMENT OF ANY INTELLECTUAL PROPERTY RIGHT; ALL SUCH WARRANTIES ARE HEREBY EXPRESSLY DISCLAIMED. SKYWORKS DOES NOT WARRANT THE ACCURACY OR COMPLETENESS OF THE INFORMATION, TEXT, GRAPHICS OR OTHER ITEMS CONTAINED WITHIN THESE MATERIALS. SKYWORKS SHALL NOT BE LIABLE FOR ANY DAMAGES, INCLUDING BUT NOT LIMITED TO ANY SPECIAL, INDIRECT, INCIDENTAL, STATUTORY, OR CONSEQUENTIAL DAMAGES, INCLUDING WITHOUT LIMITATION, LOST REVENUES OR LOST PROFITS THAT MAY RESULT FROM THE USE OF THE MATERIALS OR INFORMATION, WHETHER OR NOT THE RECIPIENT OF MATERIALS HAS BEEN ADVISED OF THE POSSIBILITY OF SUCH DAMAGE.

Skyworks products are not intended for use in medical, lifesaving or life-sustaining applications, or other equipment in which the failure of the Skyworks products could lead to personal injury, death, physical or environmental damage. Skyworks customers using or selling Skyworks products for use in such applications do so at their own risk and agree to fully indemnify Skyworks for any damages resulting from such improper use or sale.

Customers are responsible for their products and applications using Skyworks products, which may deviate from published specifications as a result of design defects, errors, or operation of products outside of published parameters or design specifications. Customers should include design and operating safeguards to minimize these and other risks. Skyworks assumes no liability for applications assistance, customer product design, or damage to any equipment resulting from the use of Skyworks products outside of stated published specifications or parameters.

Skyworks, the Skyworks symbol, and "Breakthrough Simplicity" are trademarks or registered trademarks of Skyworks Solutions, Inc., in the United States and other countries. Third-party brands and names are for identification purposes only, and are the property of their respective owners. Additional information, including relevant terms and conditions, posted at www.skyworksinc.com, are incorporated by reference.

Looking for pricing, stock, or lifecycle information?

Click below to explore more details on WIN SOURCE:

- ⊖ [View AAT1236IRN-T1 on WIN SOURCE](#)
- ⊖ [Skyworks Solutions Inc. Information](#)

Optimize Your Supply Chain with WIN SOURCE Solutions

- ✓ Global Sourcing Solution
- ✓ Obsolete Management
- ✓ Cost Control Management
- ✓ Shortage Management
- ✓ Alternative Solution
- ✓ Excess Inventory Management