



**THE DATASHEET OF
AAT2113BIXS-0.6-T1**



3.3MHz, Fast Transient 1.5A Step-Down Converter in an 2mm x 2mm Package

General Description

The AAT2113B SwitchReg™ is a 1.5A step-down converter with a typical input voltage of 3.3V and a fixed output voltage of 1.2V or an adjustable output. The 3.3MHz switching frequency enables the use of small external components. The ultra-small 2mm x 2mm footprint and high efficiency make the AAT2113B an ideal choice for portable applications.

The AAT2113B delivers 1.5A maximum output current while consuming only 55µA no-load quiescent current. Low $R_{DS(ON)}$ integrated MOSFETs and 100% duty cycle operation make the AAT2113B the ideal choice for high output voltage, high current applications which require a low dropout threshold.

The AAT2113B provides excellent transient response and output accuracy across the operating range. No external compensation is required.

The AAT2113B maintains high efficiency throughout the load range. The unique low-noise architecture reduces ripple and spectral noise. The AAT2113B automatically optimizes efficiency during Light Load mode (LL) and maintains constant frequency and low output ripple during PWM mode.

Over-temperature and short circuit protection safeguard the AAT2113B and system components from damage.

The AAT2113B is available in a Pb-free, ultra-small, low profile, 8-pin 2mm x 2mm FTDFN package. The product is rated over a temperature range of -40°C to 85°C.

Features

- 5mm x 5mm Total Solution Size
- 1.5A Maximum Output Current
- Tiny 0.47µH Chip Inductor
- Excellent Transient Response
- Input Voltage: 2.7V to 5.5V
- Ultra-small, Low Profile 8-pin 2mm x 2mm FTDFN Package
- Fixed or Adjustable Output Voltage Options:
 - Fixed Output Voltage: 1.2V
 - Adjustable Output Voltage: 1.0V to 2.5V
- High Efficiency, Low Noise Architecture
- 3.3MHz Switching Frequency
- No External Compensation Required
- 55µA No Load Quiescent Current
- 100% Duty Cycle Low-Dropout Operation
- Internal Soft Start
- Over-Temperature and Current Limit Protection
- <1µA Shutdown Current
- -40°C to 85°C Temperature Range

Applications

- Cellular Phones
- Digital Cameras
- Hard Disk Drives
- MP3 Players
- PDAs and Handheld Computers
- Portable Media Players
- USB Devices
- Wireless Network Cards

Typical Application

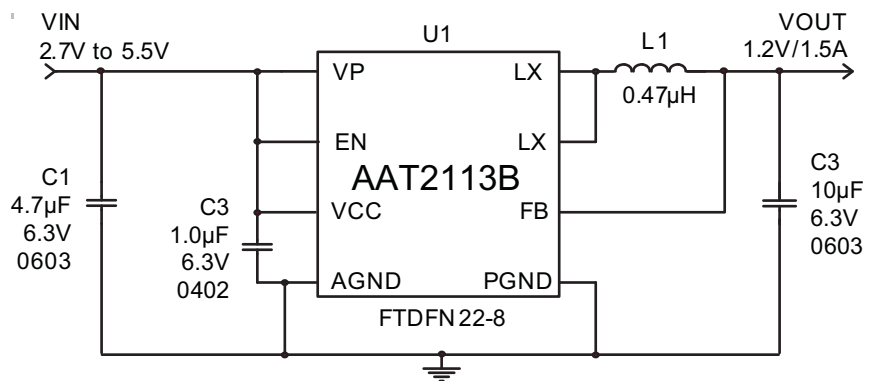
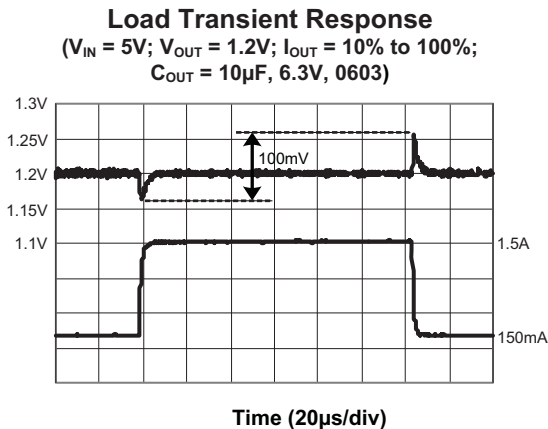

AAT2113B**3.3MHz, Fast Transient 1.5A Step-Down Converter in an 2mm x 2mm Package****Pin Descriptions**

Pin #	Symbol	Function
1	PGND	Main power ground return pin. Connect to the output and input capacitor return.
2	VP	Input power supply tied to the source of the high side P-channel MOSFET.
3	VCC	Power supply; supplies power for the internal circuitry.
4	FB	Feedback input pin. This pin is connected directly to the converter output for the 1.2V fixed output version, or connected to an external resistor divider for the adjustable output version.
5	AGND	Analog ground. This pin is internally connected to the analog ground of the control circuitry.
6	EN	Enable pin. A logic low disables the converter and it consumes less than 1 μ A of current. When connected high, it resumes normal operation.
7, 8	LX	Switching node. Connect the inductor to this pin. It is internally connected to the drain of both high and low side MOSFETs.

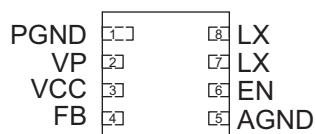
Pin Configuration**FTDFN22-8
(Top View)**

AAT2113B**3.3MHz, Fast Transient 1.5A Step-Down Converter in an 2mm x 2mm Package****Absolute Maximum Ratings¹**

$T_A = 25^\circ\text{C}$ unless otherwise noted.

Symbol	Description	Value	Units
V_{CC}, V_P	VP, VCC to GND	6.0	V
V_{LX}	LX to GND	-0.3 to $V_P + 0.3$	V
V_{FB}	FB to GND	-0.3 to $V_P + 0.3$	V
EN	EN to GND	-0.3 to $V_{CC} + 0.3$	V
T_J	Operating Junction Temperature Range	-40 to 150	$^\circ\text{C}$
T_{LEAD}	Maximum Soldering Temperature (at leads, 10 sec.)	300	$^\circ\text{C}$

Thermal Characteristics

Symbol	Description	Value	Units
Θ_{JA}	Maximum Thermal Resistance	70	$^\circ\text{C}/\text{W}$
P_D	Maximum Power Dissipation ^{2, 3}	1.4	W

1. Stresses above those listed in Absolute Maximum Ratings may cause permanent damage to the device. Functional operation at conditions other than the operating conditions specified is not implied. Only one Absolute Maximum Rating should be applied at any one time.

2. Mounted on an FR4 board.

3. Derate 14mW/ $^\circ\text{C}$ above 25 $^\circ\text{C}$.

3.3MHz, Fast Transient 1.5A Step-Down Converter in an 2mm x 2mm Package**Electrical Characteristics¹**

$V_{IN} = 3.3V$, $T_A = -40^{\circ}C$ to $85^{\circ}C$ unless otherwise noted. Typical values are at $T_A = 25^{\circ}C$.

Symbol	Description	Conditions	Min	Typ	Max	Units
V_{IN}	Input Voltage		2.7	3.3	5.5	V
V_{OUT}	Output Voltage Range		1	1.2	2.5	V
V_{UVLO}	UVLO Threshold	V_{IN} rising			2.4	V
		Hysteresis		180		mV
		V_{IN} falling	1.6			V
V_{OUT}	Output Voltage Tolerance	$I_{OUT} = 0A$ to $1.5A$, $V_{IN} = 3.3V$, $V_{OUT} = 1.2V$ fixed	-3.0		+3.0	%
I_Q	Quiescent Current	No Load		55	90	μA
I_{SHDN}	Shutdown Current	EN = GND			1.0	μA
I_{LIM}	Current Limit		2	3		A
$R_{DS(ON)H}$	High Side Switch On-Resistance			140		$m\Omega$
$R_{DS(ON)L}$	Low Side Switch On-Resistance			100		$m\Omega$
$\Delta V_{LOADREG}$	Load Regulation	$I_{LOAD} = 0A$ to $1.5A$		0.5		%
$\frac{\Delta V_{LINEREG}}{\Delta V_{IN}}$	Line Regulation	$V_{IN} = 3.3V$ to $4.0V$		0.3		%/V
V_{FB}	Feedback Threshold Voltage Accuracy (Adjustable Version)	No load, $T_A = 25^{\circ}C$	0.591	0.60	0.609	V
$I_{LXLEAK,R}$	LX Reverse Leakage Current	V_{IN} unconnected, $V_{LX} = 5.5V$, EN = GND			1.0	μA
I_{FBLEAK}	FB Leakage Current	$V_{OUT} = 1.2V$			0.2	μA
F_{OSC}	Internal Oscillator Frequency		2.6	3.3	3.8	MHz
T_S	Start-up Time	Enable to Output Regulation		60		μs
T_{SD}	Over-Temperature Shutdown Threshold			140		$^{\circ}C$
T_{HYS}	Over-Temperature Shutdown Hysteresis			25		$^{\circ}C$
EN Logic						
V_{IL}	EN Threshold Low				0.4	V
V_{IH}	EN Threshold High		1.4			V
I_{LEAK}	EN Leakage Current	$V_{EN} = 5.5V$	-1.0		1.0	μA

1. The AAT2113B is guaranteed to meet performance specifications over the $-40^{\circ}C$ to $+85^{\circ}C$ operating temperature range and is assured by design, characterization, and correlation with statistical process controls.

AAT2113B

3.3MHz, Fast Transient 1.5A Step-Down Converter in a 2mm x 2mm Package

Typical Characteristics

Efficiency vs. Output Current
($V_{OUT} = 1.2V$; $L = 0.47\mu H$)

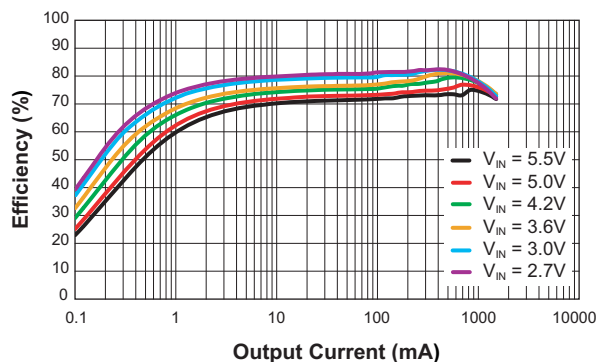

Load Regulation
($V_{OUT} = 1.2V$; $L = 0.47\mu H$)

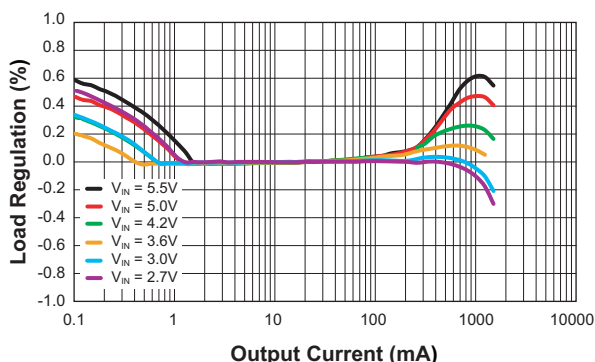

Efficiency vs. Output Current
($V_{OUT} = 1.8V$; $L = 0.82\mu H$)

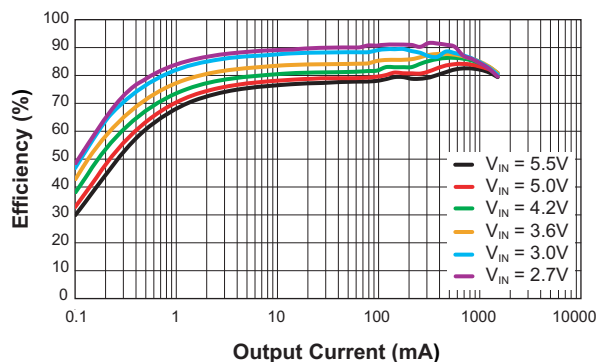

Load Regulation
($V_{OUT} = 1.8V$; $L = 0.82\mu H$)

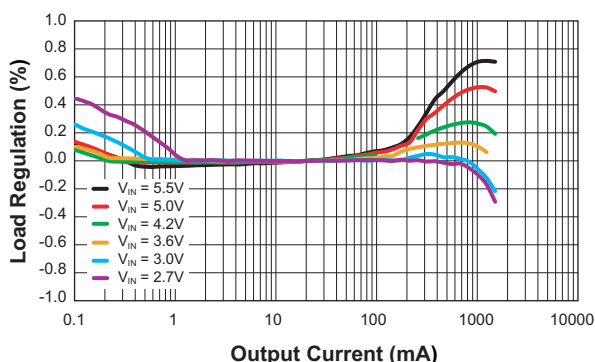

Efficiency vs. Output Current
($V_{OUT} = 2.5V$; $L = 1\mu H$)

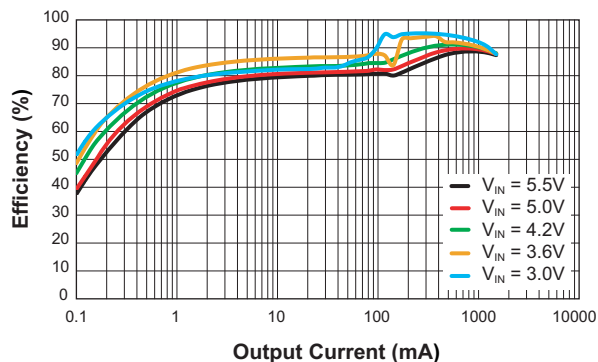

Load Regulation
($V_{OUT} = 2.5V$; $L = 1\mu H$)

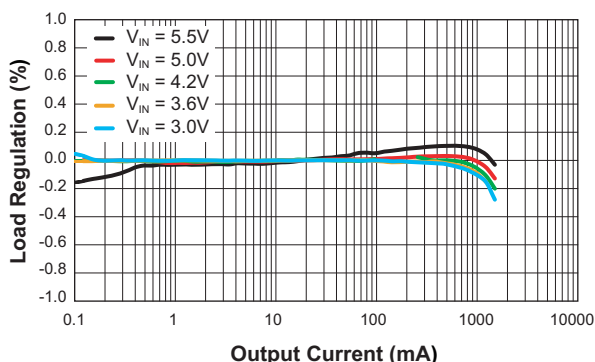

AAT2113B

3.3MHz, Fast Transient 1.5A Step-Down Converter in an 2mm x 2mm Package

Typical Characteristics

Output Voltage Error vs. Temperature
($V_{OUT} = 1.2V$; $V_{IN} = 3.3V$; $I_{OUT} = 1A$)

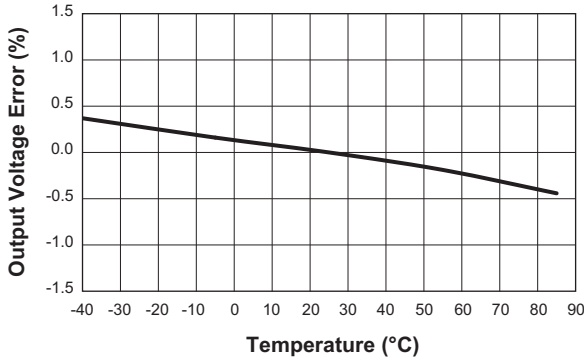

Output Voltage vs. Input Voltage
($V_{OUT} = 1.2V$; $I_{OUT} = 1A$)

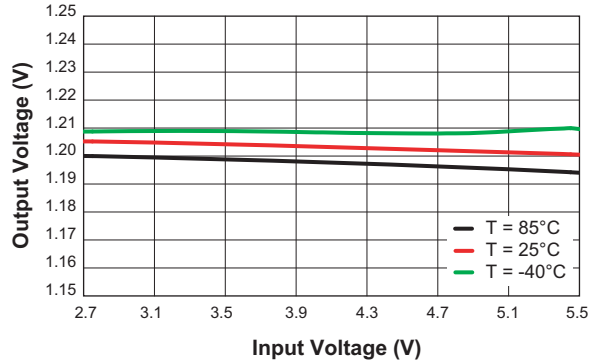

Output Voltage Error vs. Temperature
($V_{OUT} = 1.8V$; $I_{OUT} = 1A$)

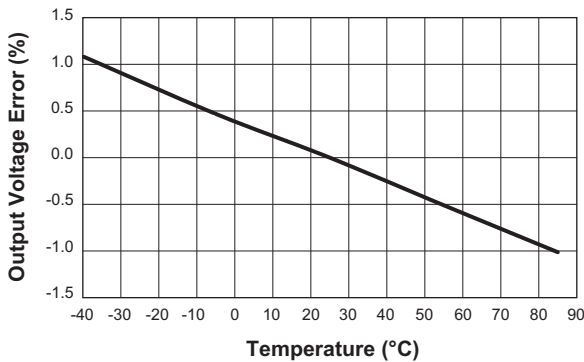

Output Voltage vs. Input Voltage
($V_{OUT} = 1.8V$; $I_{OUT} = 1A$)

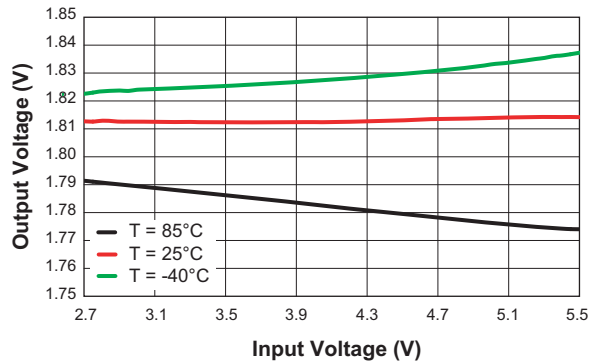

Output Voltage Error vs. Temperature
($V_{OUT} = 2.5V$; $I_{OUT} = 1A$)

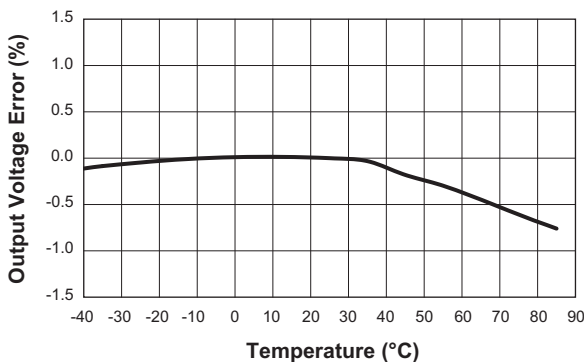

Output Voltage vs. Input Voltage
($V_{OUT} = 2.5V$; $I_{OUT} = 1A$)

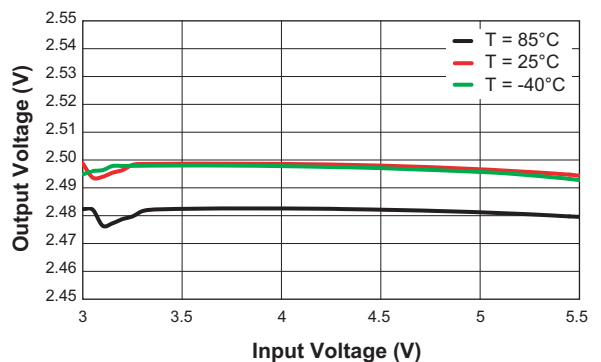

AAT2113B

3.3MHz, Fast Transient 1.5A Step-Down Converter in an 2mm x 2mm Package

Typical Characteristics

Switching Frequency vs. Temperature
($I_{OUT} = 1A$)

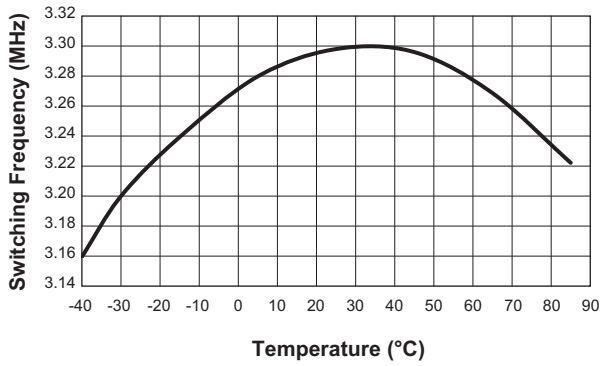

Quiescent Current vs. Input Voltage
(No Load)

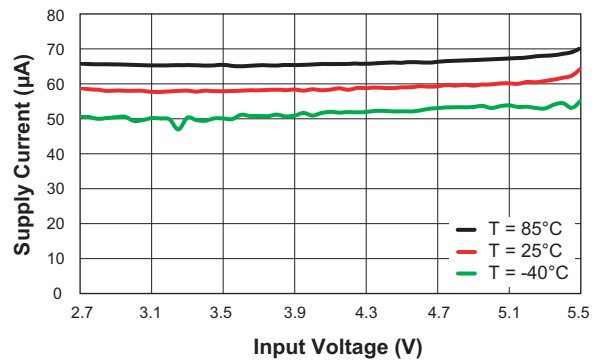

Load Transient

($V_{OUT} = 1.2V$; $V_{IN} = 3.3V$; $I_{OUT} = 0$ to $1.5A$; $C_{OUT} = 10\mu F$)

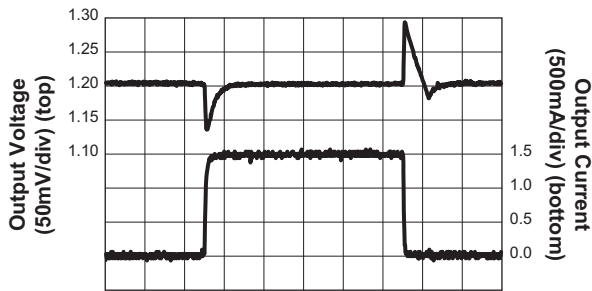

Time (20µs/div)

Load Transient

($V_{OUT} = 1.2V$; $V_{IN} = 3.3V$; $I_{OUT} = 75mA$ to $1350mA$; $C_{OUT} = 10\mu F$)

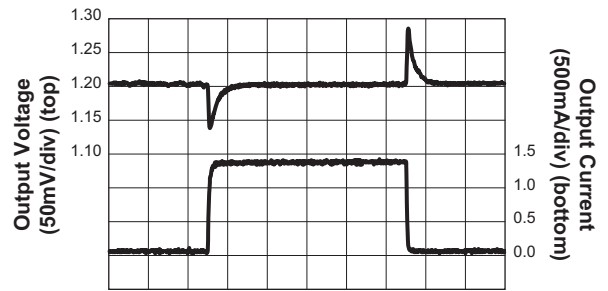

Time (20µs/div)

Load Transient

($V_{OUT} = 1.8V$; $V_{IN} = 3.3V$; $I_{OUT} = 0$ to $1.5A$; $C_{OUT} = 10\mu F$)

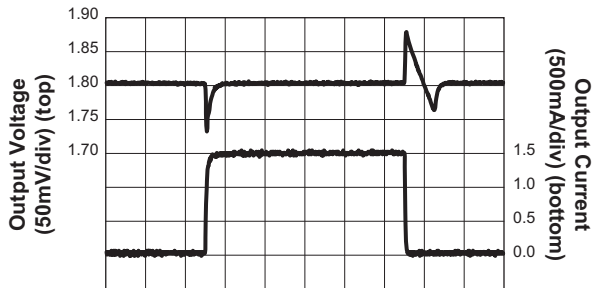

Time (20µs/div)

Load Transient

($V_{OUT} = 1.8V$; $V_{IN} = 3.3V$; $I_{OUT} = 75mA$ to $1350mA$; $C_{OUT} = 10\mu F$)

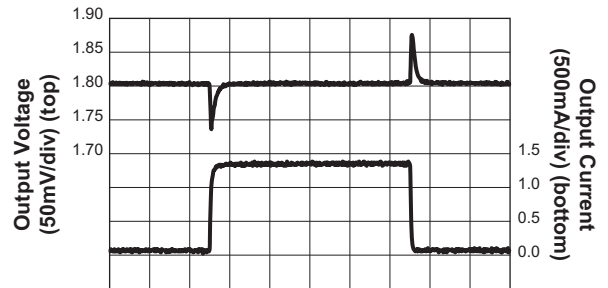

Time (20µs/div)

AAT2113B

3.3MHz, Fast Transient 1.5A Step-Down Converter in a 2mm x 2mm Package

Typical Characteristics

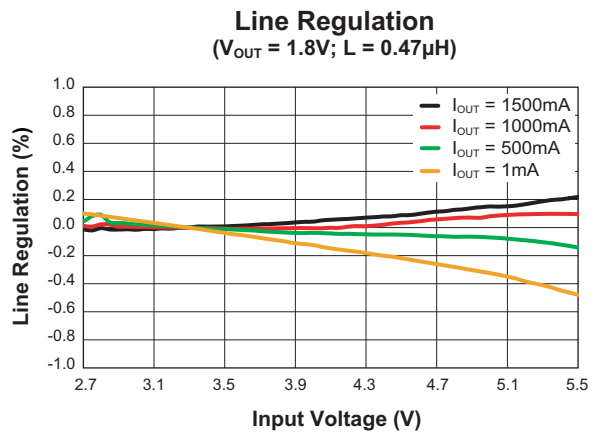
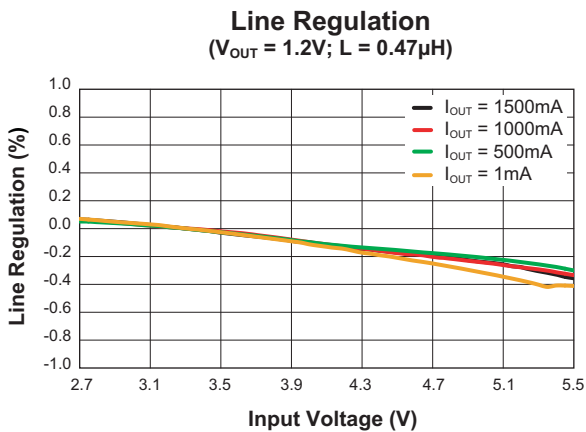
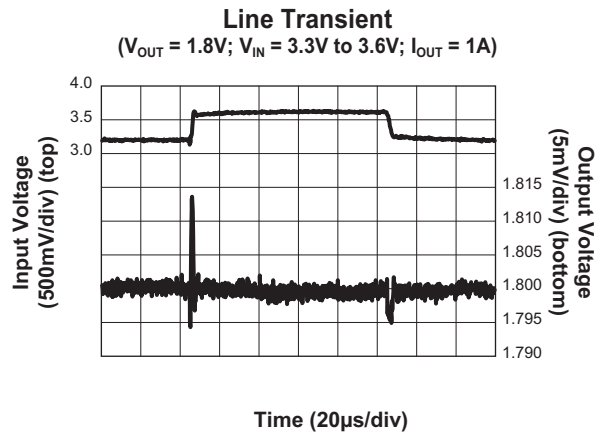
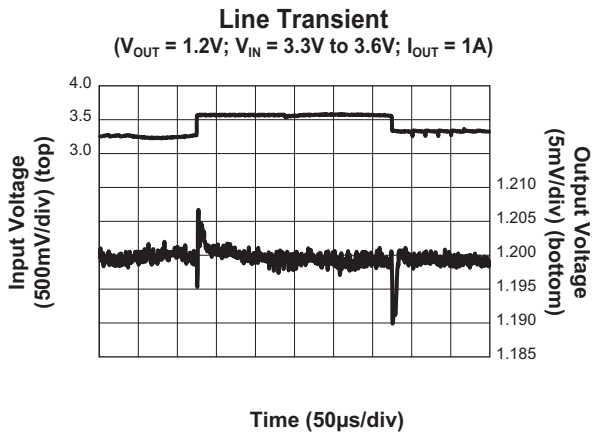
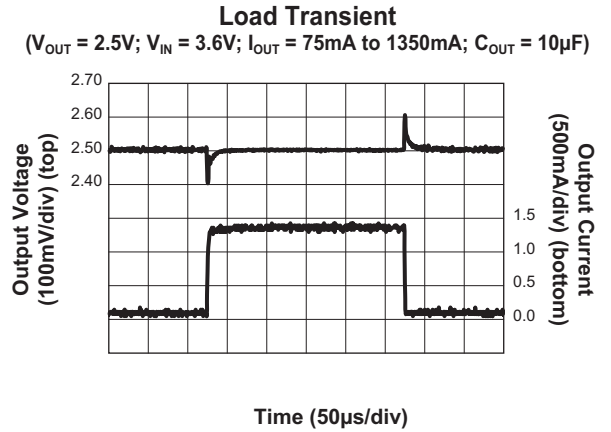
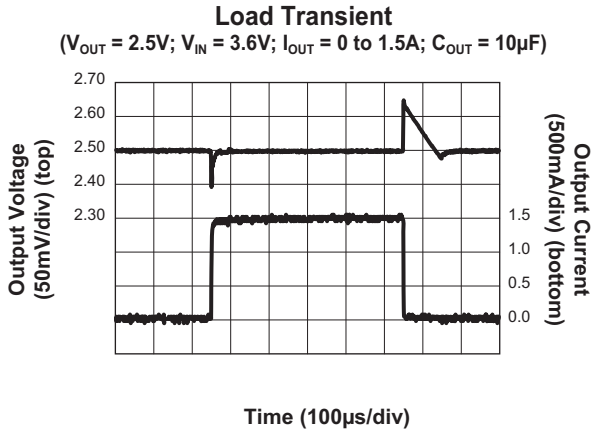

AAT2113B

3.3MHz, Fast Transient 1.5A Step-Down Converter in an 2mm x 2mm Package

Typical Characteristics

Line Regulation
($V_{OUT} = 2.5V$; $L = 1\mu H$)

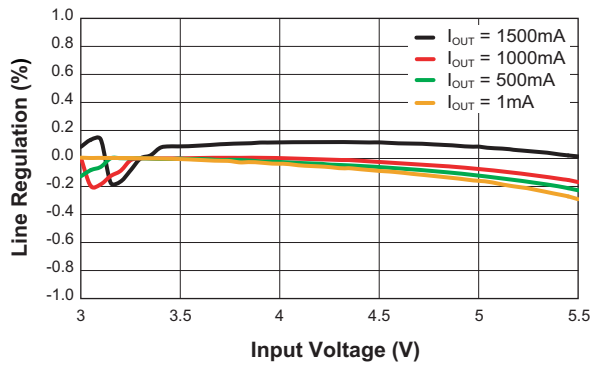

Soft Start
($V_{OUT} = 1.2V$; $V_{IN} = 3.3V$; $I_{OUT} = 1A$)

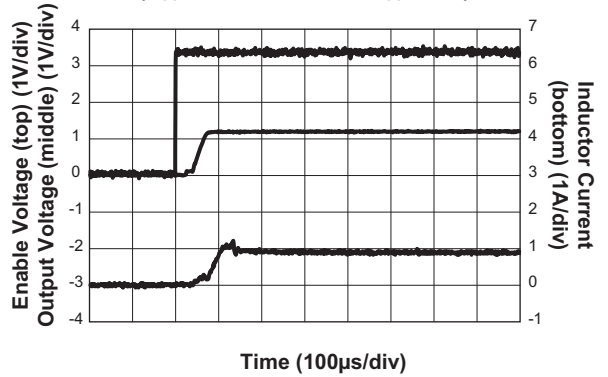

Soft Start
($V_{OUT} = 1.8V$; $V_{IN} = 3.3V$; $I_{OUT} = 1A$)

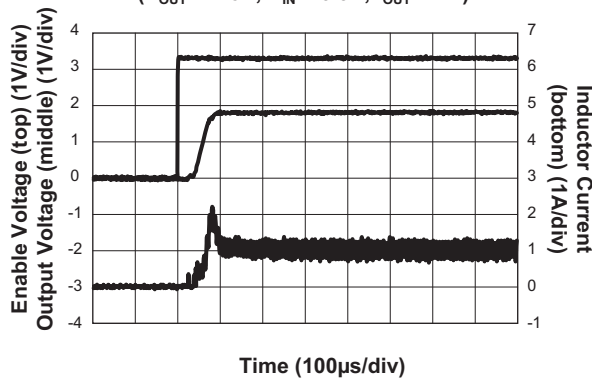

Soft Start
($V_{OUT} = 2.5V$; $V_{IN} = 3.3V$; $I_{OUT} = 1A$)

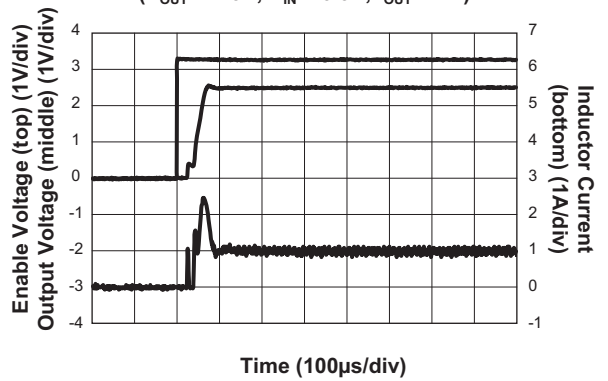

Output Voltage Ripple
($V_{OUT} = 1.2V$; $V_{IN} = 3.3V$; $I_{OUT} = 1.5A$)

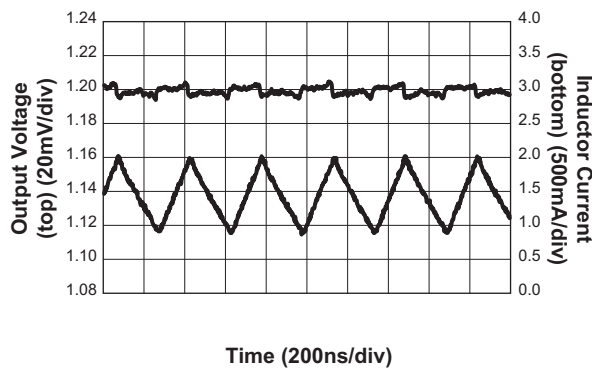

Output Voltage Ripple
($V_{OUT} = 1.2V$; $V_{IN} = 3.3V$; $I_{OUT} = 1mA$)

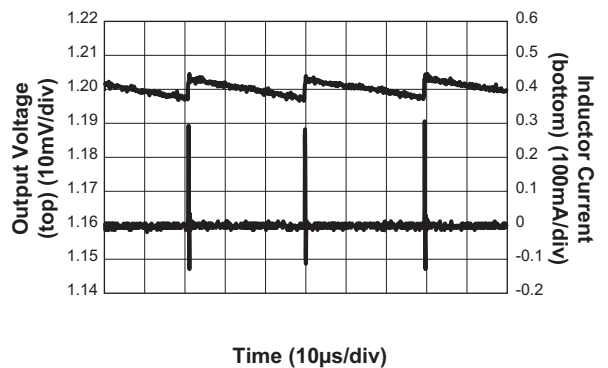

AAT2113B

3.3MHz, Fast Transient 1.5A Step-Down Converter in an 2mm x 2mm Package

Typical Characteristics

Output Voltage Ripple
($V_{OUT} = 1.8V$; $V_{IN} = 3.3V$; $I_{OUT} = 1.5A$)

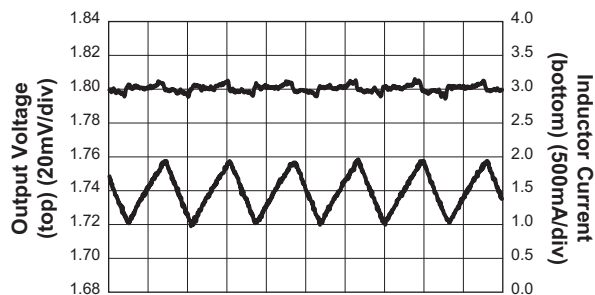

Time (200ns/div)

Output Voltage Ripple
($V_{OUT} = 1.8V$; $V_{IN} = 3.3V$; $I_{OUT} = 1mA$)

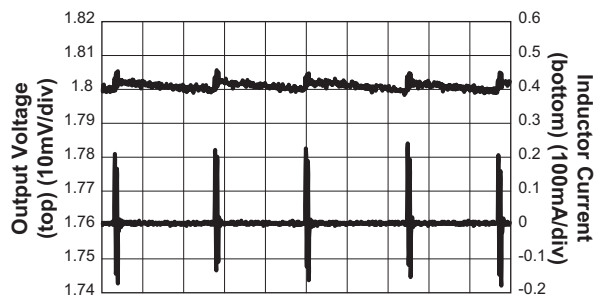

Time (10µs/div)

Output Voltage Ripple
($V_{OUT} = 1.8V$; $V_{IN} = 3.3V$; $I_{OUT} = 1.5A$)

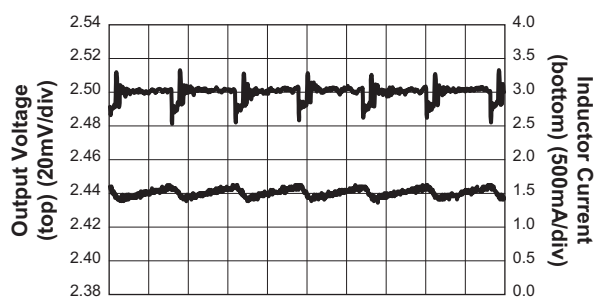

Time (200ns/div)

Output Voltage Ripple
($V_{OUT} = 2.5V$; $V_{IN} = 3.3V$; $I_{OUT} = 1mA$)

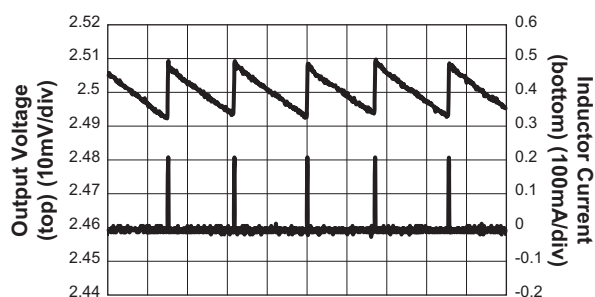

Time (50µs/div)

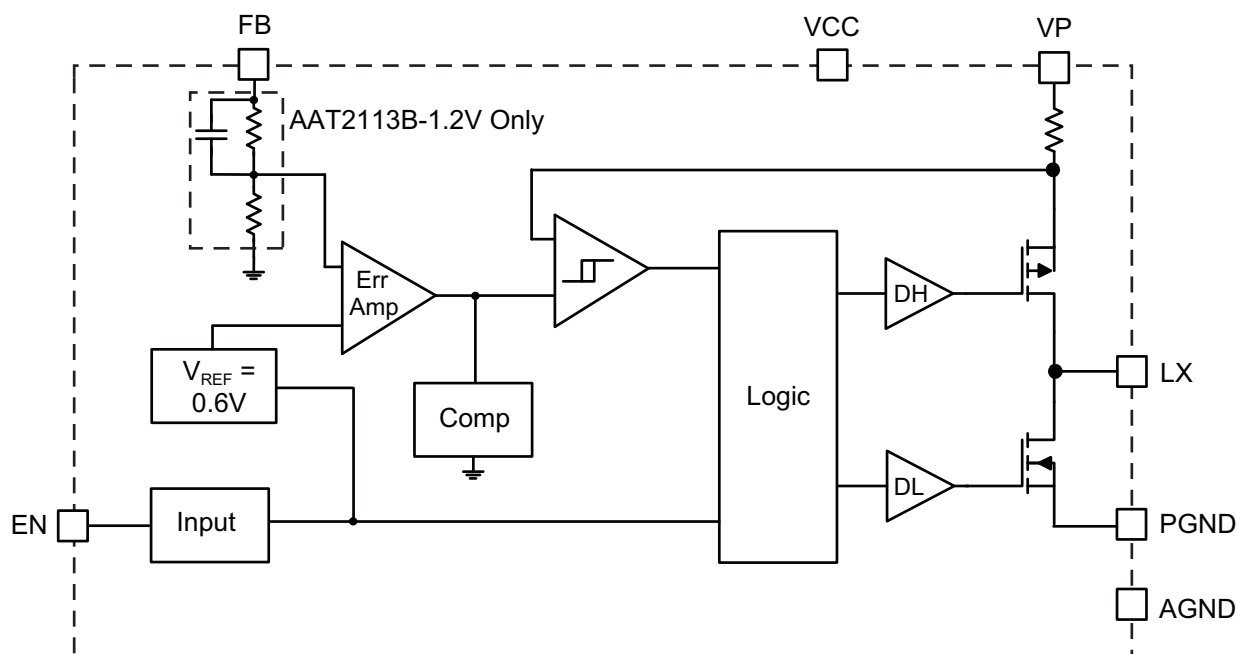
3.3MHz, Fast Transient 1.5A Step-Down Converter in an 2mm x 2mm Package**Functional Block Diagram****Functional Description**

The AAT2113B SwitchReg is a 1.5A step-down converter with a typical input voltage of 3.3V and a fixed output voltage of 1.2V. The 3.3MHz switching frequency enables the use of small external components. The ultra-small, 2mm x 2mm footprint and high efficiency make the AAT2113B an ideal choice for portable applications. Typically, a 0.47 μ H inductor and a 10 μ F ceramic capacitor are recommended for a 1.2V output (see Figure 2 for recommended values).

At dropout, the converter duty cycle increases to 100% and the output voltage tracks the input voltage minus the $R_{DS(ON)}$ drop of the P-channel high-side MOSFET (plus the DC drop of the external inductor). The device integrates extremely low $R_{DS(ON)}$ MOSFETs to achieve low dropout voltage during 100% duty cycle operation.

The integrated low-loss MOSFET switches can provide excellent efficiency at heavy loads. Light load operation maintains high efficiency, low ripple and low spectral noise even at lower currents (typically <150mA). PWM mode operation maintains constant frequency and low output ripple at output loads greater than 200mA.

In battery-powered applications, as V_{IN} decreases, the converter dynamically adjusts the operating frequency prior to dropout to maintain the required duty cycle and provide accurate output regulation. Output regulation is maintained until the dropout voltage, or minimum input voltage, is reached. At 1.5A output load, dropout voltage headroom is approximately 200mV.

The AAT2113B typically achieves better than $\pm 0.5\%$ output regulation across the input voltage and output load range. A current limit of 3.0A (typical) protects the IC and system components from short-circuit damage. Typical no load quiescent current is 55 μ A.

Thermal protection completely disables switching when the maximum junction temperature is detected. The junction over-temperature threshold is 140 $^{\circ}$ C with 25 $^{\circ}$ C of hysteresis. Once an over-temperature or over-current fault condition is removed, the output voltage automatically recovers.

Peak current mode control and optimized internal compensation provide high loop bandwidth and excellent response to input voltage and fast load transient events. Soft start eliminates output voltage overshoot when the enable or the input voltage is applied. Under-voltage lockout prevents spurious start-up events.

AAT2113B

3.3MHz, Fast Transient 1.5A Step-Down Converter in an 2mm x 2mm Package

Control Loop

The AAT2113B is a peak current mode step-down converter. The current through the P-channel MOSFET (high side) is sensed for current loop control, as well as short-circuit and overload protection. A fixed slope compensation signal is added to the sensed current to maintain stability for duty cycles greater than 50%. The peak current mode loop appears as a voltage-programmed current source in parallel with the output capacitor.

The output of the voltage error amplifier programs the current mode loop for the necessary peak switch current to force a constant output voltage for all load and line conditions. Internal loop compensation terminates the transconductance voltage error amplifier output. The reference voltage is internally set to program the converter output voltage greater than or equal to 0.6V.

Soft Start/Enable

Soft start limits the current surge seen at the input and eliminates output voltage overshoot. The enable input, when pulled low, forces the AAT2113B into a low-power, non-switching state. The total input current during shutdown is less than 1 μ A.

Current Limit and Over-Temperature Protection

For overload conditions, the peak input current is limited. To minimize power dissipation and stresses under current limit and short-circuit conditions, switching is terminated after entering current limit for a series of pulses. Switching is terminated for seven consecutive clock cycles after a current limit has been sensed for a series of four consecutive clock cycles.

Thermal protection completely disables switching when internal dissipation becomes excessive. The junction over-temperature threshold is 140°C with 25°C of hys-

teresis. Once an over-temperature or over-current fault condition is removed, the output voltage automatically recovers.

Under-Voltage Lockout

Internal bias of all circuits is controlled via the VCC input. Under-voltage lockout (UVLO) guarantees sufficient V_{IN} bias and proper operation of all internal circuitry prior to activation.

Component Selection

Inductor Selection

The step-down converter uses peak current mode control with slope compensation to maintain stability for duty cycles greater than 50%. The output inductor value must be selected so the inductor current down slope meets the internal slope compensation requirements.

For applications where the duty cycle is less than 50%, the inductor values can be chosen freely.

Manufacturer's specifications list both the inductor DC current rating, which is a thermal limitation, and the peak current rating, which is determined by the saturation characteristics. The inductor should not show any appreciable saturation under normal load conditions.

Some inductors may meet the peak and average current ratings yet result in excessive losses due to a high DCR.

Always consider the losses associated with the DCR and its effect on the total converter efficiency when selecting an inductor.

For low cost application and a sufficiently small footprint in a 5x5mm area, the LQM2HPNR47MG0 shielded chip inductor, which has 40m Ω DCR and 1.8A DC current rating, is selected for 1.2V output.

The inductors listed in Table 1 have been used with the AAT2113B.

Manufacturer	Part Number	Value (μ H)	DC Resistance (Ω)	Size (mm)
Murata	LQM2HPNR47MG0	0.47 \pm 20%	0.04 \pm 25%	2.5x2.0x1.0
Coilcraft	EPL2010-421ML	0.42 \pm 20%	0.04 \pm 25%	2.0x2.0x1.0
	EPL2010-681ML	0.68 \pm 20%	0.058 \pm 25%	2.0x2.0x1.0

Table 1: AAT2113B List of Inductors.

3.3MHz, Fast Transient 1.5A Step-Down Converter in an 2mm x 2mm Package

Input Capacitor

Select a 4.7 μ F to 10 μ F X7R or X5R ceramic capacitor for the input. To estimate the required input capacitor size, determine the acceptable input ripple level (V_{PP}) and solve for C. The calculated value varies with input voltage and is a maximum when V_{IN} is double the output voltage.

$$C_{IN} = \frac{\frac{V_O}{V_{IN}} \cdot \left(1 - \frac{V_O}{V_{IN}}\right)}{\left(\frac{V_{PP}}{I_O} - ESR\right) \cdot F_S}$$

$$\frac{V_O}{V_{IN}} \cdot \left(1 - \frac{V_O}{V_{IN}}\right) = \frac{1}{4} \text{ for } V_{IN} = 2 \cdot V_O$$

$$C_{IN(MIN)} = \frac{1}{\left(\frac{V_{PP}}{I_O} - ESR\right) \cdot 4 \cdot F_S}$$

Always examine the ceramic capacitor DC voltage coefficient characteristics when selecting the proper value. For example, the capacitance of a 10 μ F, 6.3V, X5R ceramic capacitor with 3.5V DC applied is actually about 5 μ F. Some examples of DC bias voltage versus capacitance for different package sizes are shown in Figure 1.

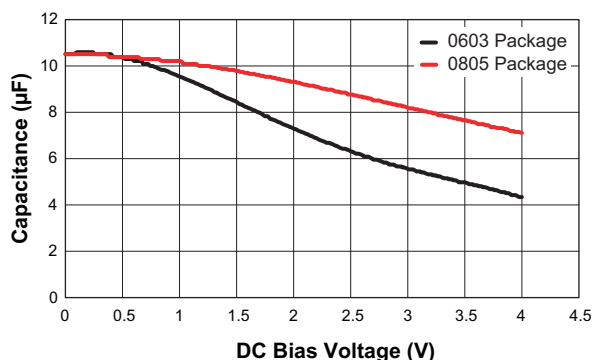

Figure 1: 10 μ F Capacitor Value vs. DC Bias Voltage for Different Package Sizes.

The maximum input capacitor RMS current is:

$$I_{RMS} = I_O \cdot \sqrt{\frac{V_O}{V_{IN}} \cdot \left(1 - \frac{V_O}{V_{IN}}\right)}$$

The input capacitor RMS ripple current varies with the input and output voltage and will always be less than or equal to half of the total DC load current.

$$\sqrt{\frac{V_O}{V_{IN}} \cdot \left(1 - \frac{V_O}{V_{IN}}\right)} = \sqrt{D \cdot (1 - D)} = \sqrt{0.5^2} = \frac{1}{2}$$

for $V_{IN} = 2 \cdot V_O$

$$I_{RMS(MAX)} = \frac{I_O}{2}$$

The term $\frac{V_O}{V_{IN}} \cdot \left(1 - \frac{V_O}{V_{IN}}\right)$ appears in both the input voltage ripple and input capacitor RMS current equations and is a maximum when V_O is twice V_{IN} . This is why the input voltage ripple and the input capacitor RMS current ripple are a maximum at 50% duty cycle. The input capacitor provides a low impedance loop for the edges of pulsed current drawn by the AAT2113B. Low ESR/ESL X7R and X5R ceramic capacitors are ideal for this function. To minimize stray inductance, the capacitor should be placed as closely as possible to the IC. This keeps the high frequency content of the input current localized, minimizing EMI and input voltage ripple. The proper placement of the input capacitor (C1) can be seen in the evaluation board layout in the Layout section of this datasheet (see Figure 3).

A laboratory test set-up typically consists of two long wires running from the bench power supply to the evaluation board input voltage pins. The inductance of these wires, along with the low-ESR ceramic input capacitor, can create a high Q network that may affect converter performance. This problem often becomes apparent in the form of excessive ringing in the output voltage during load transients. Errors in the loop phase and gain measurements can also result.

Since the inductance of a short PCB trace feeding the input voltage is significantly lower than the power leads from the bench power supply, most applications do not exhibit this problem.

In applications where the input power source lead inductance cannot be reduced to a level that does not affect the converter performance, a high ESR tantalum or aluminum electrolytic should be placed in parallel with the low ESR/ESL bypass ceramic capacitor. This dampens the high Q network and stabilizes the system.

3.3MHz, Fast Transient 1.5A Step-Down Converter in an 2mm x 2mm Package

Output Capacitor

The output capacitor limits the output ripple and prevents the output voltage droop during large load transitions. A 10µF to 22µF X5R or X7R ceramic capacitor typically provides sufficient bulk capacitance to stabilize the output during large load transitions and has the ESR and ESL characteristics necessary for low output ripple.

The output voltage droop due to a load transient is dominated by the capacitance of the ceramic output capacitor.

During a step increase in load current, the ceramic output capacitor alone supplies the load current until the loop responds. Within two or three switching cycles, the loop responds and the inductor current increases to match the load current demand. The relationship of the output voltage droop during the three switching cycles to the output capacitance can be estimated by:

$$C_{OUT} = \frac{3 \cdot \Delta I_{LOAD}}{V_{DROOP} \cdot F_S}$$

Once the average inductor current increases to the DC load level, the output voltage recovers. The above equation establishes a limit on the minimum value for the output capacitor with respect to load transients.

The internal voltage loop compensation also limits the minimum output capacitor value to 10µF. This is due to its effect on the loop crossover frequency (bandwidth), phase margin, and gain margin. Increased output capacitance will reduce the crossover frequency with greater phase margin.

Feedback Resistor Selection

Resistors R1 and R2 of Figure 5 program the output to regulate at a voltage higher than 0.6V for the AAT2113B adjustable version. To limit the bias current required for the external feedback resistor string while maintaining good noise immunity, the suggested value for R2 is 200kΩ. Table 1 summarizes the resistor values for various output voltages with R2 set to either 59kΩ or 200kΩ. Alternately, the feedback resistor may be calculated using the following equation:

$$R1 = \left(\frac{V_{OUT}}{V_{REF}} - 1 \right) \cdot R2 = \left(\frac{1.8V}{0.6V} - 1 \right) \cdot 200k\Omega = 400k\Omega$$

The AAT2113B adjustable version, combined with an external feed forward capacitor (C2 in Figure 5), delivers enhanced transient response for extreme pulsed load applications. The suggested value for C2 is in the range of 22pF to 100pF.

V _{OUT} (V)	R2 = 59kΩ R1 (kΩ)	R2 = 200kΩ R1 (kΩ)
1.0	39.2	133
1.1	49.9	165
1.2	59	200
1.3	68.1	232
1.4	78.7	267
1.5	88.7	301
1.6	97.6	332
1.7	107	365
1.8	118	400
2.5	187	634

Table 2: Feedback Resistor Selection for Adjustable Output Voltage Version.

Thermal Calculations

There are three types of losses associated with the AAT2113B step-down converter: switching losses, conduction losses, and quiescent current losses. Conduction losses are associated with the R_{DS(ON)} characteristics of the power output switching devices. Switching losses are dominated by the gate charge of the power output switching devices. At full load, assuming continuous conduction mode (CCM), a simplified form of the losses is given by:

$$P_{TOTAL} = \frac{I_O^2 \cdot (R_{DS(ON)H} \cdot V_O + R_{DS(ON)L} \cdot [V_{IN} - V_O])}{V_{IN}} + (t_{sw} \cdot F_S \cdot I_O + I_Q) \cdot V_{IN}$$

I_Q is the step-down converter quiescent current. The term t_{sw} is used to estimate the full load step-down converter switching losses. For the condition where the step-down converter is in dropout at 100% duty cycle, the total device dissipation reduces to:

$$P_{TOTAL} = I_O^2 \cdot R_{DS(ON)H} + (t_{sw} \cdot F_S \cdot I_O + I_Q) \cdot V_{IN}$$

3.3MHz, Fast Transient 1.5A Step-Down Converter in an 2mm x 2mm Package

Since $R_{DS(ON)}$, quiescent current, and switching losses all vary with input voltage, the total losses should be investigated over the complete input voltage range.

Given the total losses, the maximum junction temperature can be derived from the θ_{JA} for the FTDFN22-8 package, which is 70°C/W.

$$T_{J(MAX)} = P_{TOTAL} \cdot \theta_{JA} + T_{AMB}$$

PCB Layout Considerations

The suggested PCB layout for the AAT2113B is shown in Figures 3 and 4 (fixed version) or Figures 6 and 7 (adjustable version). The following guidelines should be used to help ensure a proper layout:

1. The input capacitor (C1) should be connected as close as possible to VP and PGND.
2. The output capacitor and L1 should be connected as closely as possible. The connection of L1 to the LX pin should be as short as possible.
3. For the fixed output version, the feedback trace or FB pin should be separated from any power trace and connected as closely as possible to the load point. Sensing along a high-current load trace will degrade DC load regulation. For the adjustable version, the trace connecting the FB pin to resistors R1 and R2 should be as short as possible by placing R1 and R2 immediately next to the AAT2113B. The sense trace connection from R1 to the output voltage should be separate from any power trace and connect as closely as possible to the load point. The external feed-forward capacitor C2 should be connected as close as possible in parallel with R1 for enhanced transient response.
4. The resistance of the trace from the load return to PGND should be kept to a minimum. This will help to minimize any error in DC regulation due to differences in the potential of the internal signal ground and the power ground.
5. Connect unused signal pins to ground to avoid unwanted noise coupling.

AAT2113B

3.3MHz, Fast Transient 1.5A Step-Down Converter in an 2mm x 2mm Package

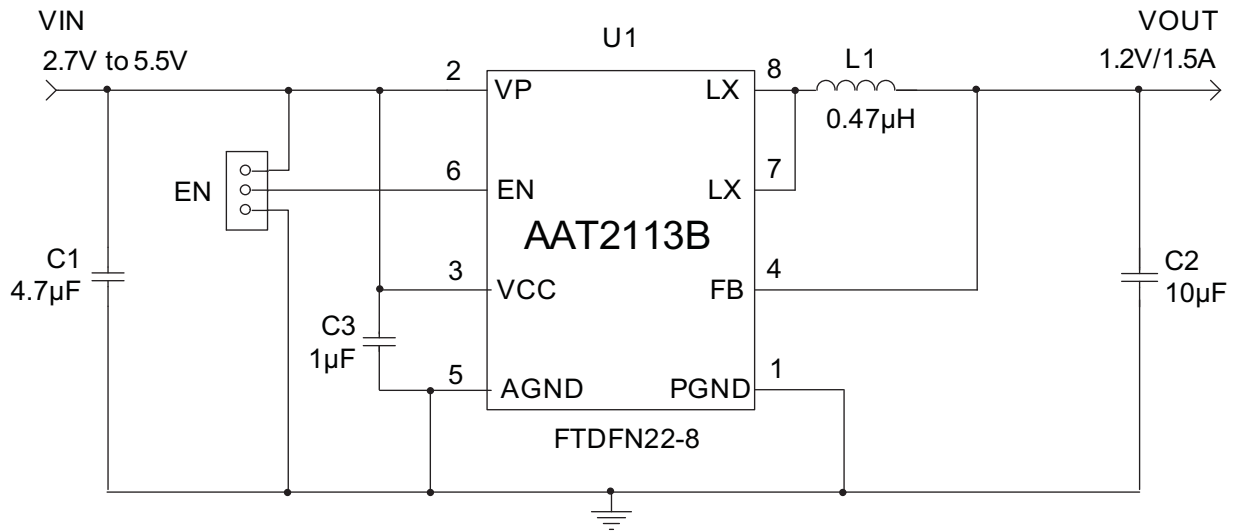

- U1 AAT2113BIXS-1.2V-T1 Skyworks, 3.3MHz Fast Transient, 1.5A Step-Down Converter , FTDFN22-8, 2x2mm
- C1 GRM188R60J475KE19D, Murata, Cap, MLC, 4.7µF/6.3V, 0603 (H_{MAX} = 0.9mm)
- L1 LQM2HPNR47MGO, Murata, 0.47µH, I_{SAT} = 1800mA, DCR = 40mΩ, 2.5 x 2 x 0.9 mm, shielded chip inductor
- C2 GRM188R60J106ME47D, Murata, Cap, MLC, 10µF/6.3V, 0603 (H_{MAX} = 0.9mm)
- C3 GRM155R60J105KE19D, Murata, Cap, MLC, 1µF/6.3V, 0402

Figure 2: AAT2113B Evaluation Board Schematic For 1.2V Fixed Output Voltage Version.

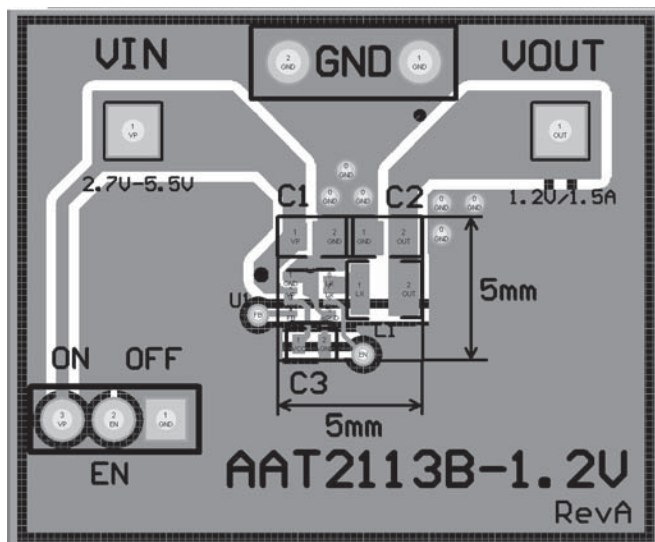

Figure 3: AAT2113B Evaluation Board Top Side Layout for 1.2V Fixed Output Voltage Version.

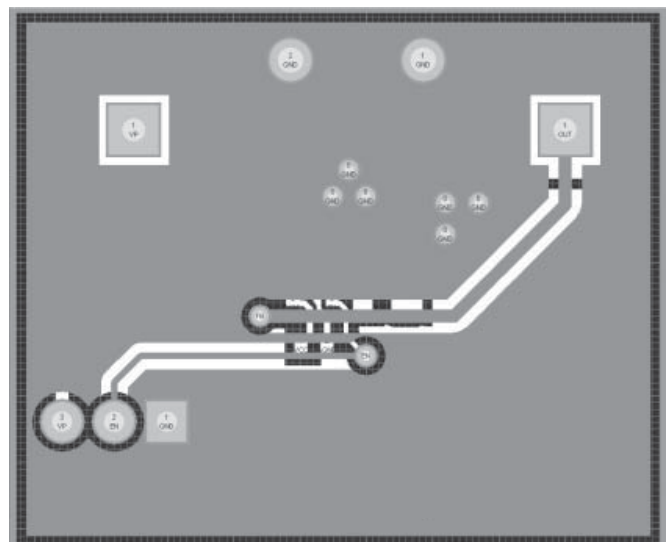
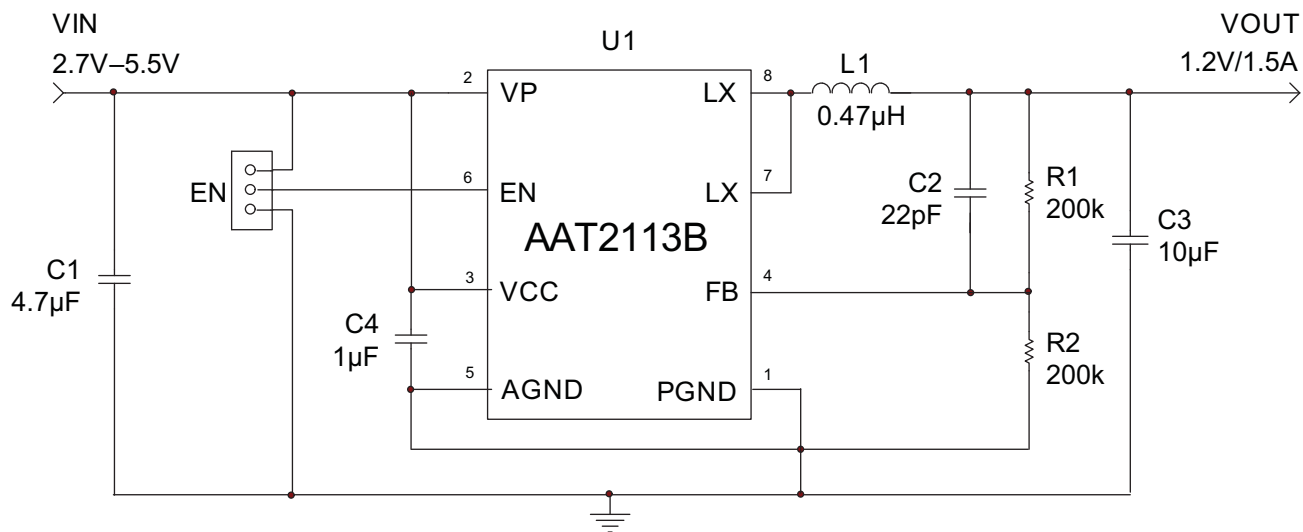

Figure 4: AAT2113B Evaluation Board Bottom Side Layout for 1.2V Fixed Output Voltage Version.

AAT2113B

3.3MHz, Fast Transient 1.5A Step-Down Converter in an 2mm x 2mm Package



- U1 AAT2113BIXS-0.6-T1 Skyworks, 3.3MHz Fast Transient, 1.5A Step-Down Converter, FTDFN22-8, 2x2mm
- C1 GRM188R60J475KE19D, Murata, Cap, MLC, 4.7µF/6.3V, 0603 (H_{MAX} = 0.8mm)
- C2 Optional, 22pF, 0201
- L1 LQM2HPNR47MGO, Murata, 0.47µH, I_{SAT} = 1.8A, DCR = 0.04Ω, 2.5 x 2 x 1mm, shielded chip inductor
- R1, R2 Carbon film resistor, 200kΩ, 1%, 0201
- R3 Carbon film resistor, 0Ω
- C3 GRM188R60J106ME47D, Murata, Cap, MLC, 10µF/6.3V, 0603 (H_{MAX} = 0.8mm)
- C4 GRM155R60J105KE19D, Murata, Cap, MLC, 1µF/6.3V, 0402

Figure 5: AAT2113B Evaluation Board Schematic For Adjustable Output Voltage Version.

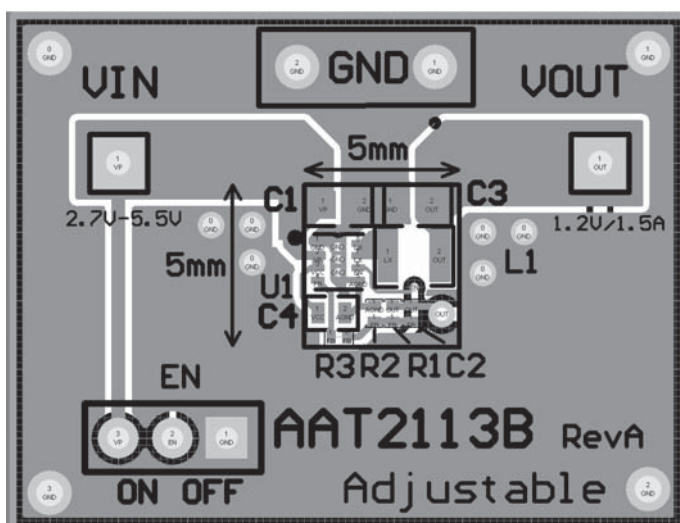

Figure 6: AAT2113B Evaluation Board

Top Side Layout for Adjustable

Output Voltage Version.

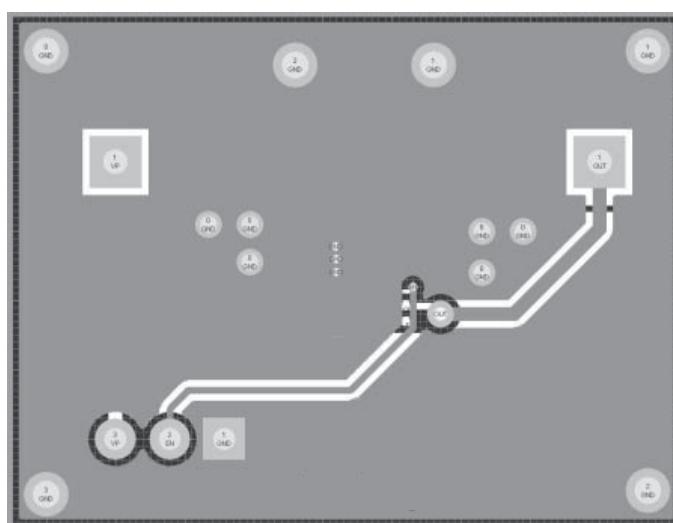

Figure 7: AAT2113B Evaluation Board

Bottom Side Layout for Adjustable

Output Voltage Version.

AAT2113B**3.3MHz, Fast Transient 1.5A Step-Down Converter in an 2mm x 2mm Package**

Figure 8: AAT2113B Application Schematic for 2.5V Output Voltage.

3.3MHz, Fast Transient 1.5A Step-Down Converter in an 2mm x 2mm Package**AAT2113B Design Example****Specifications**

$V_{OUT} = 1.2V @ 1.5A$, Pulsed Load $\Delta I_{LOAD} = 1.5A$
 $V_{IN} = 3.3V$
 $F_S = 3.3MHz$
 $T_{AMB} = 85^\circ C$ in 8-pin 2x2mm DFN low profile package

Output Inductor

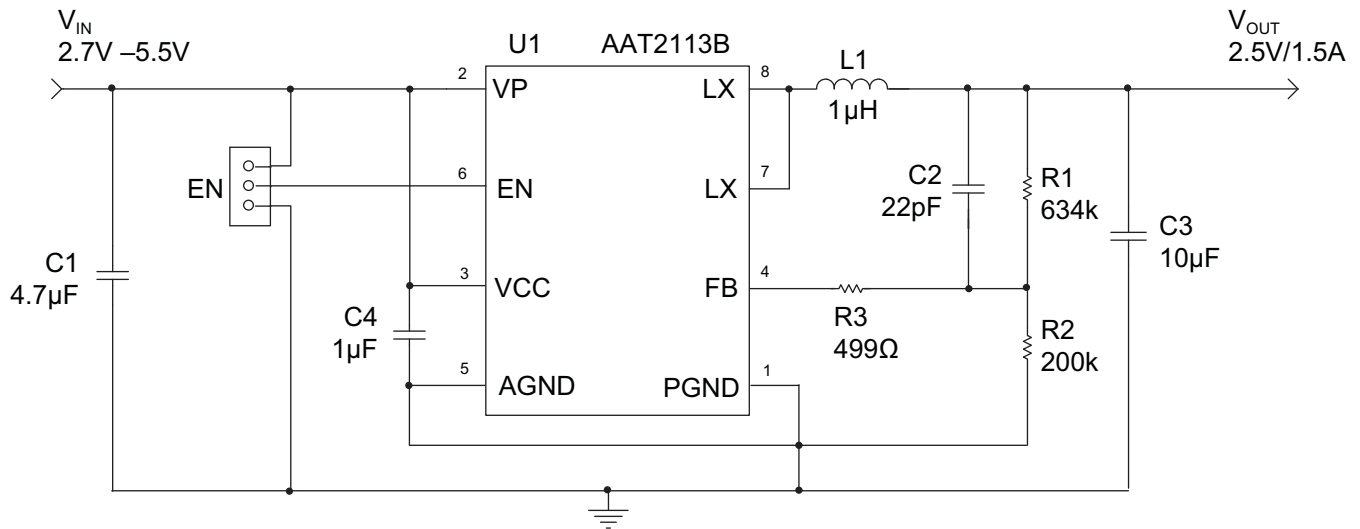
For Murata, 0.47 μH LQM2HPNRR47MG0 shielded chip inductor has a 40m Ω DCR.

$$\Delta I = \frac{V_O}{L_1 \cdot F_S} \cdot \left(1 - \frac{V_O}{V_{IN}}\right) = \frac{1.2V}{0.47\mu H \cdot 3.3MHz} \cdot \left(1 - \frac{1.2V}{3.3V}\right) = 0.492mA$$

$$I_{PK} = I_{OUT} + \frac{\Delta I}{2} = 1.5A + 0.271A = 1.75A$$

$$P_{L1} = I_{OUT}^2 \cdot DCR = 1.5A^2 \cdot 40m\Omega = 90mW$$

Output Capacitor

For $V_{DROOP} = 0.12V$ (10% Output Voltage)

$$C_{OUT} = \frac{3 \cdot \Delta I_{LOAD}}{V_{DROOP} \cdot F_S} = \frac{3 \cdot 1.5A}{0.12V \cdot 3.3MHz} = 11.4\mu F; \text{ use } 10\mu F$$

For $V_{DROOP} = 0.06V$ (5% Output Voltage)

$$C_{OUT} = \frac{3 \cdot \Delta I_{LOAD}}{V_{DROOP} \cdot F_S} = \frac{3 \cdot 1.5A}{0.06V \cdot 3.3MHz} = 22.7\mu F; \text{ use } 22\mu F$$

$$I_{RMS(MAX)} = \frac{1}{2 \cdot \sqrt{3}} \cdot \frac{V_{OUT} \cdot (V_{IN(MAX)} - V_{OUT})}{L \cdot F_S \cdot V_{IN(MAX)}} = \frac{1}{2 \cdot \sqrt{3}} \cdot \frac{1.2V \cdot (3.3V - 1.2V)}{0.47\mu H \cdot 3.3MHz \cdot 3.3V} = 142mA_{rms}$$

$$P_{RMS} = ESR \cdot I_{RMS}^2 = 5m\Omega \cdot (142mA)^2 = 0.1mW$$

3.3MHz, Fast Transient 1.5A Step-Down Converter in an 2mm x 2mm Package**Input Capacitor**

For Input Ripple $V_{pp} = 30\text{mV}$

$$C_{IN} = \frac{1}{\left(\frac{V_{PP}}{I_O} - ESR\right) \cdot 4 \cdot F_S} = \frac{1}{\left(\frac{30\text{mV}}{1.5\text{A}} - 5\text{m}\Omega\right) \cdot 4 \cdot 3.3\text{MHz}} = 5\mu\text{F}; \text{ use } 4.7\mu\text{F}$$

$$I_{RMS} = \frac{I_{OUT1}}{2} = 0.75\text{A}$$

$$P = ESR \cdot (I_{RMS})^2 = 5\text{m}\Omega \cdot (0.75\text{A})^2 = 2.8\text{mW}$$

AAT2113B Losses

All values assume 85°C ambient temperature and thermal resistance of 70°C/W in the 8-pin 2x2mm DFN low profile package.

$$\begin{aligned} P_{TOTAL} &= I_{OUT}^2 \cdot R_{DS(ON)H} + (t_{SW} \cdot F_{SW} \cdot I_{OUT} + I_Q) \cdot V_{IN} \\ &= 1.5\text{A}^2 \cdot 152\text{m}\Omega + (5\text{ns} \cdot 3.3\text{MHz} \cdot 1.5\text{A} + 50\mu\text{A}) \cdot 3.3\text{V} \\ &= 423\text{mW} \end{aligned}$$

$$T_{J(MAX)} = T_{AMB} + \Theta_{JA} \cdot P_{LOSS} = 85^\circ\text{C} + (70^\circ\text{C/W}) \cdot 423\text{mW} = 115^\circ\text{C}$$

AAT2113B

3.3MHz, Fast Transient 1.5A Step-Down Converter in an 2mm x 2mm Package

Ordering Information

Output Voltage	Package	Marking ¹	Part Number (Tape and Reel) ²
1.2V	FTDFN22-8		AAT2113BIXS-1.2-T1
Adjustable (0.6V)	FTDFN22-8	K9XYY	AAT2113BIXS-0.6-T1

 Skyworks Green™ products are compliant with all applicable legislation and are halogen-free. For additional information, refer to *Skyworks Definition of Green™*, document number SQ04-0074.

Package Information

FTDFN22-8³

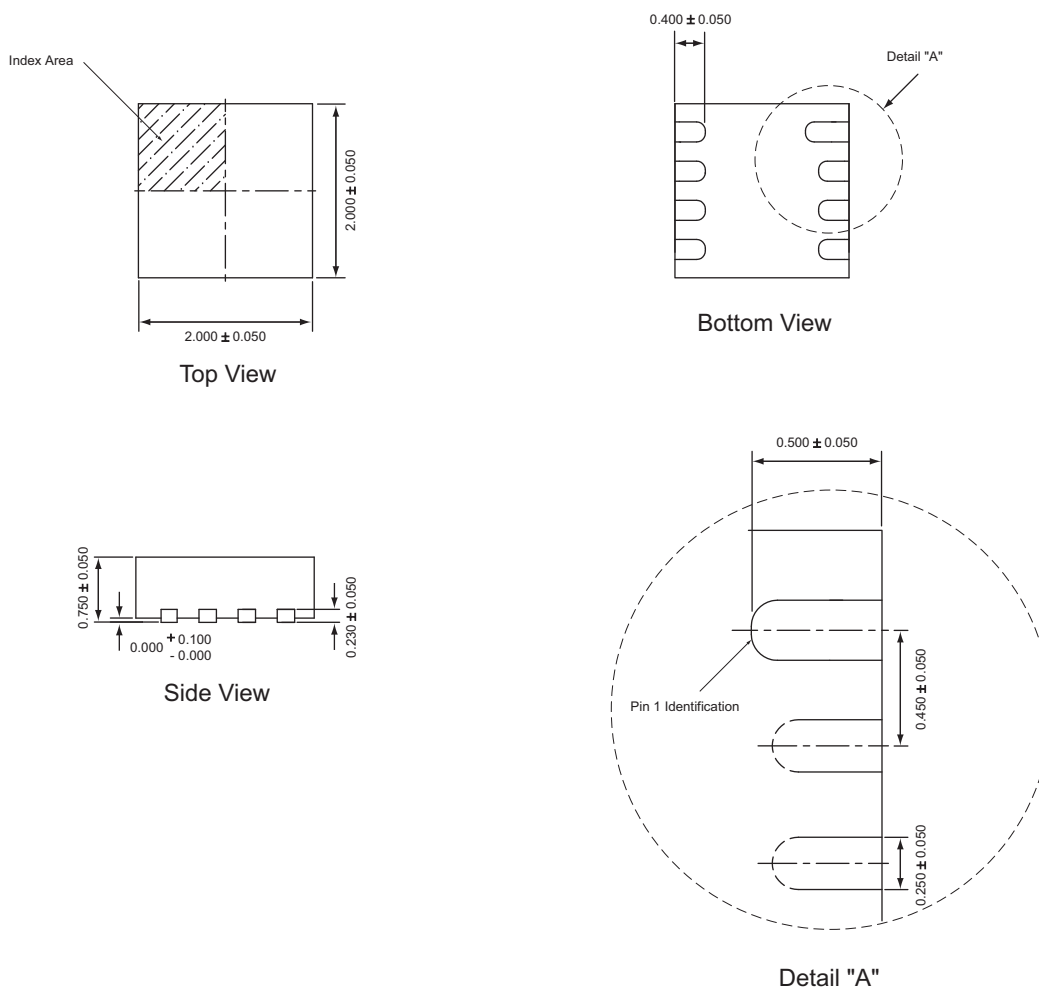

1. XYY = assembly and date code.
 2. Sample stock is generally held on part numbers listed in **BOLD**.
 3. The leadless package family, which includes QFN, TQFN, DFN, TDFN and STDFN, has exposed copper (unplated) at the end of the lead terminals due to the manufacturing process. A solder fillet at the exposed copper edge cannot be guaranteed and is not required to ensure a proper bottom solder connection.

3.3MHz, Fast Transient 1.5A Step-Down Converter in an 2mm x 2mm Package

Copyright © 2012 Skyworks Solutions, Inc. All Rights Reserved.

Information in this document is provided in connection with Skyworks Solutions, Inc. ("Skyworks") products or services. These materials, including the information contained herein, are provided by Skyworks as a service to its customers and may be used for informational purposes only by the customer. Skyworks assumes no responsibility for errors or omissions in these materials or the information contained herein. Skyworks may change its documentation, products, services, specifications or product descriptions at any time, without notice. Skyworks makes no commitment to update the materials or information and shall have no responsibility whatsoever for conflicts, incompatibilities, or other difficulties arising from any future changes.

No license, whether express, implied, by estoppel or otherwise, is granted to any intellectual property rights by this document. Skyworks assumes no liability for any materials, products or information provided hereunder, including the sale, distribution, reproduction or use of Skyworks products, information or materials, except as may be provided in Skyworks Terms and Conditions of Sale.

THE MATERIALS, PRODUCTS AND INFORMATION ARE PROVIDED "AS IS" WITHOUT WARRANTY OF ANY KIND, WHETHER EXPRESS, IMPLIED, STATUTORY, OR OTHERWISE, INCLUDING FITNESS FOR A PARTICULAR PURPOSE OR USE, MERCHANTABILITY, PERFORMANCE, QUALITY OR NON-INFRINGEMENT OF ANY INTELLECTUAL PROPERTY RIGHT; ALL SUCH WARRANTIES ARE HEREBY EXPRESSLY DISCLAIMED. SKYWORKS DOES NOT WARRANT THE ACCURACY OR COMPLETENESS OF THE INFORMATION, TEXT, GRAPHICS OR OTHER ITEMS CONTAINED WITHIN THESE MATERIALS. SKYWORKS SHALL NOT BE LIABLE FOR ANY DAMAGES, INCLUDING BUT NOT LIMITED TO ANY SPECIAL, INDIRECT, INCIDENTAL, STATUTORY, OR CONSEQUENTIAL DAMAGES, INCLUDING WITHOUT LIMITATION, LOST REVENUES OR LOST PROFITS THAT MAY RESULT FROM THE USE OF THE MATERIALS OR INFORMATION, WHETHER OR NOT THE RECIPIENT OF MATERIALS HAS BEEN ADVISED OF THE POSSIBILITY OF SUCH DAMAGE.



Skyworks products are not intended for use in medical, lifesaving or life-sustaining applications, or other equipment in which the failure of the Skyworks products could lead to personal injury, death, physical or environmental damage. Skyworks customers using or selling Skyworks products for use in such applications do so at their own risk and agree to fully indemnify Skyworks for any damages resulting from such improper use or sale.

Customers are responsible for their products and applications using Skyworks products, which may deviate from published specifications as a result of design defects, errors, or operation of products outside of published parameters or design specifications. Customers should include design and operating safeguards to minimize these and other risks. Skyworks assumes no liability for applications assistance, customer product design, or damage to any equipment resulting from the use of Skyworks products outside of stated published specifications or parameters.

Skyworks, the Skyworks symbol, and "Breakthrough Simplicity" are trademarks or registered trademarks of Skyworks Solutions, Inc., in the United States and other countries. Third-party brands and names are for identification purposes only, and are the property of their respective owners. Additional information, including relevant terms and conditions, posted at www.skyworksinc.com, are incorporated by reference.

Looking for pricing, stock, or lifecycle information?

Click below to explore more details on WIN SOURCE:

-  [View AAT2113BIXS-0.6-T1 on WIN SOURCE](#)
-  [Skyworks Solutions Inc. Information](#)

Optimize Your Supply Chain with WIN SOURCE Solutions

-  Global Sourcing Solution
-  Obsolete Management
-  Cost Control Management
-  Shortage Management
-  Alternative Solution
-  Excess Inventory Management