



**THE DATASHEET OF
XC6201P392MR**



Positive Voltage Regulators

■ GENERAL DESCRIPTION

The XC6201 series are highly precise, low power consumption, positive voltage regulators manufactured using CMOS and laser trimming technologies.

The series provides large currents with a significantly small dropout voltage.

The XC6201 consists of a current limiter circuit, a driver transistor, a precision reference voltage and an error amplifier. Output voltage is selectable in 0.1V steps between 1.3V ~ 6.0V.

SOT-25, SOT-89 and USP-6B packages are available.

■ APPLICATIONS

- Smart phones / Mobile phones
- Portable game consoles
- Digital still cameras / Camcorders
- Digital audio equipment
- Reference voltage sources
- Multi-function power supplies

■ FEATURES

| | |
|---|---|
| Maximum Output Current | : 250mA (TYP.) |
| Dropout Voltage | : 0.16V @ 100mA : 0.40V @ 200mA |
| Maximum Operating Voltage | : 10V |
| Output Voltage Range | : 1.3V ~ 6.0V (0.1V increments) |
| Fixed Voltage Accuracy | : $\pm 1\%$ ($V_{OUT(T)} \geq 2.0V$) : $\pm 2\%$ |
| Low Power Consumption | : 2.0 μ A (TYP.) |
| Operating Ambient Temperature | : -40°C ~ 85°C |
| Packages | : SOT-25, SOT-89 USP-6B |
| Environmentally Friendly | : EU RoHS Compliant, Pb Free |
| Tantalum or Ceramic Capacitor compatible | |

■ TYPICAL APPLICATION CIRCUIT



■ TYPICAL PERFORMANCE CHARACTERISTICS

- Supply Current vs. Input Voltage



■ BLOCK DIAGRAM



■ PRODUCT CLASSIFICATION

● Ordering Information

XC6201P ③④⑤⑥⑦-⑧^(*)

↑ ↑

① ②

| DESIGNATOR | ITEM | SYMBOL | DESCRIPTION |
|------------|--------------------------|--------|-------------------------|
| ① | Product Number | 01 | - |
| ② | Type of Regulator | P | 3-pin regulator |
| ③④ | Output Voltage | 13~60 | e.g. 30:3.0V 50:5.0V |
| ⑤ | Output Voltage Accuracy | 1 | ±1% |
| | | 2 | ±2% |
| ⑥⑦-⑧ | Packages (Order Unit) | MR | SOT-25 (3,000pcs/Reel) |
| | | MR-G | SOT-25 (3,000pcs/Reel) |
| | | PR | SOT-89 (1,000pcs/Reel) |
| | | PR-G | SOT-89 (1,000pcs/Reel) |
| | | DR | USP-6B (3,000pcs/Reel) |
| | | DR-G | USP-6B (3,000pcs/Reel) |

^(*) The "-G" suffix denotes Halogen and Antimony free as well as being fully EU RoHS compliant.

* ±1% accuracy can be set at $V_{OUT(T)} \geq 2.0V$.

■ PIN CONFIGURATION



SOT-25
(TOP VIEW)



SOT-89
(TOP VIEW)



*The dissipation pad for the USP-6B package should be solder-plated in recommended mount pattern and metal masking so as to enhance mounting strength and heat release. If the pad needs to be connected to other pins, it should be connected to the VSS (No.5) pin.

■ PIN ASSIGNMENT

| PIN NUMBER | | | PIN NAME | FUNCTION |
|------------|--------|--------|------------------|---------------|
| SOT-25 | SOT-89 | USP-6B | | |
| 5 | 1 | 3 | V _{OUT} | Output |
| 2 | 2 | 5 | V _{SS} | Ground |
| 1 | 3 | 1 | V _{IN} | Power Input |
| 3, 4 | — | 2,4,6 | NC | No Connection |

■ ABSOLUTE MAXIMUM RATINGS

T_a = 25°C

| PARAMETER | SYMBOL | RATINGS | UNITS |
|-----------------------|------------------|---|-------|
| Input Voltage | V _{IN} | 12.0 | V |
| Output Current | I _{OUT} | 500 | mA |
| Output Voltage | V _{OUT} | V _{SS} -0.3~V _{IN} +0.3 | V |
| Power Dissipation | SOT-25 | 250 | mW |
| | SOT-89 | 500 | |
| | USP-6B | 120 | |
| Operating Temperature | T _{opr} | -40~+85 | °C |
| Storage Temperature | T _{stg} | -55~+125 | °C |

ELECTRICAL CHARACTERISTICS

XC6201P132

$V_{OUT(T)}=1.3V$ (*1)

$T_a=25^\circ\text{C}$

| PARAMETER | SYMBOL | CONDITIONS | MIN. | TYP. | MAX. | UNITS | CIRCUIT |
|--|--|--|-------|-----------|-------|-----------------------|---------|
| Output Voltage | $V_{OUT(E)}$ (*2) | $V_{IN}=2.3V$ $I_{OUT}=10mA$ | 1.274 | 1.300 | 1.326 | V | ② |
| Maximum Output Current | I_{OUTmax} | $V_{IN}=2.3V$ $V_{OUT(E)} \geq 1.17V$ | 60 | - | - | mA | ② |
| Load Regulation | ΔV_{OUT} | $V_{IN}=2.3V$ $1mA \leq I_{OUT} \leq 30mA$ | - | 10 | 30 | mV | ② |
| Dropout Voltage (*3) | Vdif1 | $I_{OUT}=30mA$ | - | 200 | 600 | mV | ② |
| | Vdif2 | $I_{OUT}=60mA$ | - | 500 | 810 | | |
| Supply Current | I_{SS} | $V_{IN}=2.3V$ | - | 2.0 | 5.0 | μA | ① |
| Line Regulation | $\frac{\Delta V_{OUT}}{\Delta V_{IN} \cdot \Delta V_{OUT}}$ | $I_{OUT}=10mA$ $2.3V \leq V_{IN} \leq 10.0V$ | - | 0.2 | 0.3 | %/V | ② |
| Input Voltage | V_{IN} | | 1.8 | - | 10 | V | - |
| Output Voltage Temperature Characteristics | $\frac{\Delta V_{OUT}}{\Delta T_{opr} \cdot \Delta V_{OUT}}$ | $I_{OUT}=40mA$ $-40^\circ\text{C} \leq T_{opr} \leq 85^\circ\text{C}$ | - | ± 100 | - | ppm/ $^\circ\text{C}$ | ② |

XC6201P182

$V_{OUT(T)}=1.8V$ (*1)

$T_a=25^\circ\text{C}$

| PARAMETER | SYMBOL | CONDITIONS | MIN. | TYP. | MAX. | UNITS | CIRCUIT |
|--|--|--|-------|-----------|-------|-----------------------|---------|
| Output Voltage | $V_{OUT(E)}$ (*2) | $V_{IN}=2.8V$ $I_{OUT}=40mA$ | 1.764 | 1.800 | 1.836 | V | ② |
| Maximum Output Current | I_{OUTmax} | $V_{IN}=2.8V$ $V_{OUT(E)} \geq 1.62V$ | 80 | - | - | mA | ② |
| Load Regulation | ΔV_{OUT} | $V_{IN}=2.8V$ $1mA \leq I_{OUT} \leq 40mA$ | - | 10 | 30 | mV | ② |
| Dropout Voltage (*3) | Vdif1 | $I_{OUT}=40mA$ | - | 200 | 370 | mV | ② |
| | Vdif2 | $I_{OUT}=80mA$ | - | 450 | 710 | | |
| Supply Current | I_{SS} | $V_{IN}=2.8V$ | - | 2.0 | 5.0 | μA | ① |
| Line Regulation | $\frac{\Delta V_{OUT}}{\Delta V_{IN} \cdot \Delta V_{OUT}}$ | $I_{OUT}=40mA$ $2.8V \leq V_{IN} \leq 10.0V$ | - | 0.2 | 0.3 | %/V | ② |
| Input Voltage | V_{IN} | | 1.8 | - | 10 | V | - |
| Output Voltage Temperature Characteristics | $\frac{\Delta V_{OUT}}{\Delta T_{opr} \cdot \Delta V_{OUT}}$ | $I_{OUT}=40mA$ $-40^\circ\text{C} \leq T_{opr} \leq 85^\circ\text{C}$ | - | ± 100 | - | ppm/ $^\circ\text{C}$ | ② |

XC6201P272

$V_{OUT(T)}=2.7V$ (*1)

$T_a=25^\circ\text{C}$

| PARAMETER | SYMBOL | CONDITIONS | MIN. | TYP. | MAX. | UNITS | CIRCUIT |
|--|--|--|-------|-----------|-------|-----------------------|---------|
| Output Voltage | $V_{OUT(E)}$ (*2) | $V_{IN}=3.7V$ $I_{OUT}=40mA$ | 2.646 | 2.700 | 2.754 | V | ② |
| Maximum Output Current | I_{OUTmax} | $V_{IN}=3.7V$ $V_{OUT(E)} \geq 2.43V$ | 100 | - | - | mA | ② |
| Load Regulation | ΔV_{OUT} | $V_{IN}=3.7V$ $1mA \leq I_{OUT} \leq 60mA$ | - | 15 | 40 | mV | ② |
| Dropout Voltage (*3) | Vdif1 | $I_{OUT}=60mA$ | - | 200 | 370 | mV | ② |
| | Vdif2 | $I_{OUT}=120mA$ | - | 450 | 710 | | |
| Supply Current | I_{SS} | $V_{IN}=3.7V$ | - | 2.0 | 5.0 | μA | ① |
| Line Regulation | $\frac{\Delta V_{OUT}}{\Delta V_{IN} \cdot \Delta V_{OUT}}$ | $I_{OUT}=40mA$ $3.7V \leq V_{IN} \leq 10.0V$ | - | 0.2 | 0.3 | %/V | ② |
| Input Voltage | V_{IN} | | 1.8 | - | 10 | V | - |
| Output Voltage Temperature Characteristics | $\frac{\Delta V_{OUT}}{\Delta T_{opr} \cdot \Delta V_{OUT}}$ | $I_{OUT}=40mA$ $-40^\circ\text{C} \leq T_{opr} \leq 85^\circ\text{C}$ | - | ± 100 | - | ppm/ $^\circ\text{C}$ | ② |

■ ELECTRICAL CHARACTERISTICS (Continued)

XC6201P332

$V_{OUT(T)}=3.3V$ (*1)

$T_a=25^\circ C$

| PARAMETER | SYMBOL | CONDITIONS | MIN. | TYP. | MAX. | UNITS | CIRCUIT |
|---|--|--|-------|-----------|-------|-----------------|---------|
| Output Voltage | $V_{OUT(E)}$ (*2) | $V_{IN}=4.3V$ $I_{OUT}=40mA$ | 3.234 | 3.300 | 3.366 | V | ② |
| Maximum Output Current | I_{OUTmax} | $V_{IN}=4.3V$ $V_{OUT(E)} \geq 2.97V$ | 150 | - | - | mA | ② |
| Load Regulation | ΔV_{OUT} | $V_{IN}=4.3V$ $1mA \leq I_{OUT} \leq 80mA$ | - | 20 | 50 | mV | ② |
| Dropout Voltage (*3) | Vdif1 | $I_{OUT}=80mA$ | - | 200 | 360 | mV | ② |
| | Vdif2 | $I_{OUT}=160mA$ | - | 450 | 700 | | |
| Supply Current | I_{SS} | $V_{IN}=4.3V$ | - | 2.0 | 5.0 | μA | ① |
| Line Regulation | $\frac{\Delta V_{OUT}}{\Delta V_{IN} \cdot \Delta V_{OUT}}$ | $I_{OUT}=40mA$ $4.3V \leq V_{IN} \leq 10.0V$ | - | 0.2 | 0.3 | %/V | ② |
| Input Voltage | V_{IN} | | 1.8 | - | 10 | V | - |
| Output Voltage Temperature Characteristics | $\frac{\Delta V_{OUT}}{\Delta T_{opr} \cdot \Delta V_{OUT}}$ | $I_{OUT}=40mA$ $-40^\circ C \leq T_{opr} \leq 85^\circ C$ | - | ± 100 | - | ppm/ $^\circ C$ | ② |

XC6201P502

$V_{OUT(T)}=5.0V$ (*1)

$T_a=25^\circ C$

| PARAMETER | SYMBOL | CONDITIONS | MIN. | TYP. | MAX. | UNITS | CIRCUIT |
|---|--|--|-------|-----------|-------|-----------------|---------|
| Output Voltage | $V_{OUT(E)}$ (*2) | $V_{IN}=6.0V$ $I_{OUT}=40mA$ | 4.900 | 5.000 | 5.100 | V | ② |
| Maximum Output Current | I_{OUTmax} | $V_{IN}=6.0V$ $V_{OUT(E)} \geq 4.57V$ | 200 | - | - | mA | ② |
| Load Regulation | ΔV_{OUT} | $V_{IN}=6.0V$ $1mA \leq I_{OUT} \leq 100mA$ | - | 30 | 70 | mV | ② |
| Dropout Voltage (*3) | Vdif1 | $I_{OUT}=100mA$ | - | 160 | 340 | mV | ② |
| | Vdif2 | $I_{OUT}=200mA$ | - | 400 | 600 | | |
| Supply Current | I_{SS} | $V_{IN}=6.0V$ | - | 2.0 | 6.0 | μA | ① |
| Line Regulation | $\frac{\Delta V_{OUT}}{\Delta V_{IN} \cdot \Delta V_{OUT}}$ | $I_{OUT}=40mA$ $6.0V \leq V_{IN} \leq 10.0V$ | - | 0.2 | 0.3 | %/V | ② |
| Input Voltage | V_{IN} | | 1.8 | - | 10 | V | - |
| Output Voltage Temperature Characteristics | $\frac{\Delta V_{OUT}}{\Delta T_{opr} \cdot \Delta V_{OUT}}$ | $I_{OUT}=40mA$ $-40^\circ C \leq T_{opr} \leq 85^\circ C$ | - | ± 100 | - | ppm/ $^\circ C$ | ② |

NOTE:

*1: $V_{OUT(T)}$ = Nominal output voltage.

*2: $V_{OUT(E)}$ = Effective output voltage (i.e. the output voltage when " $V_{OUT(T)}+1.0V$ " is provided while maintaining a certain I_{OUT} value).

*3: $V_{dif} = (V_{IN1} - V_{OUT1})$

V_{IN1} :An Input Voltage when V_{OUT1} appears as the input voltage is gradually decreased.

V_{OUT1} : A voltage equal to 98% of the output voltage when a stabilized ($V_{OUT(T)} + 1.0V$) is input.

TEST CIRCUITS

Circuit ① : Supply Current



Circuit ② : Output Voltage, Oscillation, Line Regulation, Dropout Voltage, Load Regulation



OPERATIONAL EXPLANATION



With the XC6201 series regulator, in order to ensure the stabilized output voltage, we suggest that an output capacitor (C_L) of $1\ \mu\text{F}$ or more be connected between the output pin (V_{OUT}) and the V_{SS} pin. For using low ESR capacitor (e.g. ceramic capacitors), please make sure that the output voltage is more than 1.7V. When the output voltage is from 1.3V to 1.6V, the output capacitor should be a tantalum capacitor with a capacitance of $2.2\ \mu\text{F}$. We also suggest an input capacitor (C_{IN}) should be connected between the V_{IN} and the V_{SS} in order to stabilize input power source.

| OUTPUT VOLTAGE | C_{IN} | C_L (TANTALUM) | C_L (LOW ESR) |
|----------------|-------------------------|-------------------------|-------------------------|
| 1.3V~1.6V | $\geq 1.0\ \mu\text{F}$ | $\geq 2.2\ \mu\text{F}$ | — |
| 1.7V~6.0V | $\geq 1.0\ \mu\text{F}$ | $\geq 1.0\ \mu\text{F}$ | $\geq 1.0\ \mu\text{F}$ |



■ NOTE ON USE

1. Please use this IC within the stated absolute maximum ratings. The IC is liable to malfunction should the ratings be exceeded. When a voltage higher than the V_{IN} flows to the V_{OUT} like when using two power supplies, please connect a Schottky barrier diode between the V_{OUT} and the V_{IN} and do not exceed the V_{OUT} rating.
2. An oscillation may occur by the impedance between a power supply and the input of the IC. Where the impedance is $10\ \Omega$ or more, please use an input capacitor (C_{IN}) of at least $1\ \mu\text{F}$. In case of high output current, operation can be stabilized by increasing the input capacitor value. Also an oscillation may occur if the input capacitor value is smaller than the input impedance when the output capacitance (C_L) is large. In such cases, operations can be stabilized by either increasing the input capacitor value or reducing the output capacitor value.
3. Please ensure that output current (I_{OUT}) is less than $P_d / (V_{IN} - V_{OUT})$ and do not exceed the rated power dissipation value (P_d) of the package.

■ TYPICAL PERFORMANCE CHARACTERISTICS

(1) Output Voltage vs. Output Current



TYPICAL PERFORMANCE CHARACTERISTICS (Continued)

(2) Output Voltage vs. Input Voltage

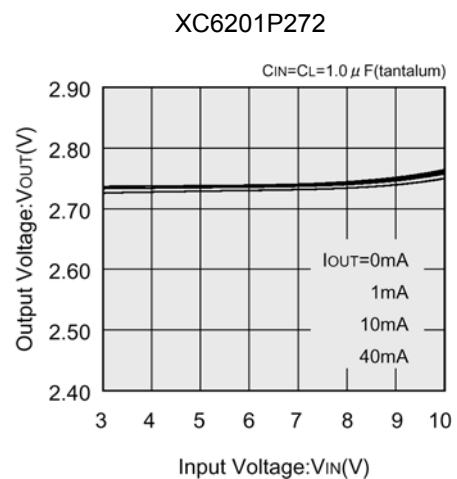
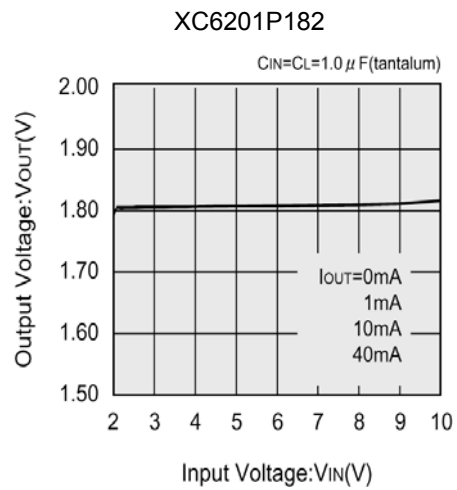
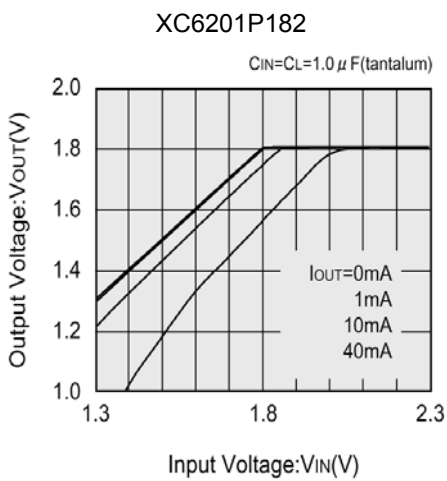
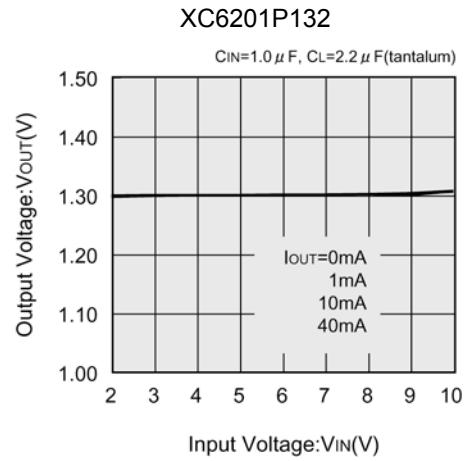
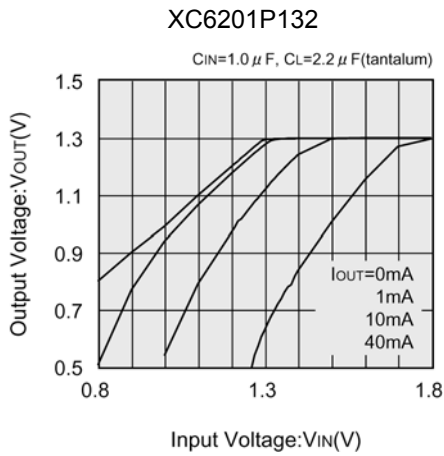

■ TYPICAL PERFORMANCE CHARACTERISTICS (Continued)

(2) Output Voltage vs. Input Voltage (Continued)



TYPICAL PERFORMANCE CHARACTERISTICS (Continued)

(3) Dropout Voltage vs. Output Current

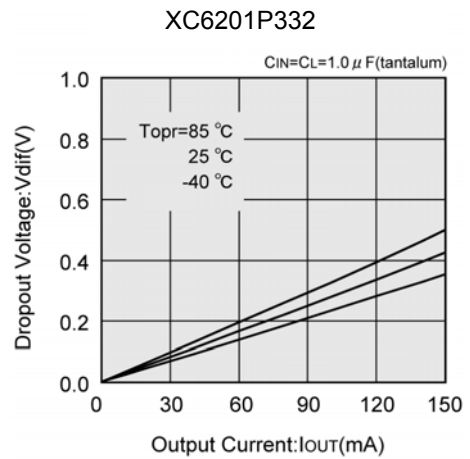
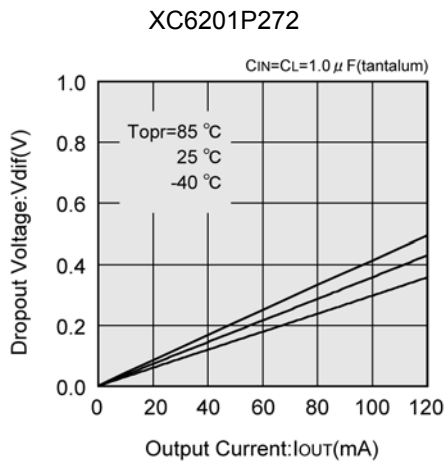
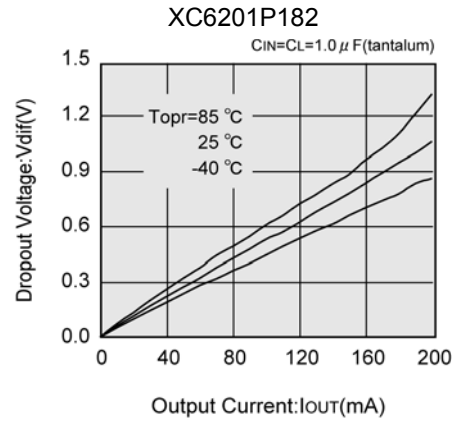

■ TYPICAL PERFORMANCE CHARACTERISTICS (Continued)

(4) Supply Current vs. Input Voltage



■ TYPICAL PERFORMANCE CHARACTERISTICS (Continued)

(4) Supply Current vs. Input Voltage (Continued)



■ TYPICAL PERFORMANCE CHARACTERISTICS (Continued)

(5) Output Voltage vs. Ambient Temperature



TYPICAL PERFORMANCE CHARACTERISTICS (Continued)

(6) Supply Current vs. Ambient Temperature

XC6201P132



XC6201P182



XC6201P272



XC6201P332



XC6201P502



■ TYPICAL PERFORMANCE CHARACTERISTICS (Continued)

(7) Input Transient Response

XC6201P132



XC6201P182



XC6201P272

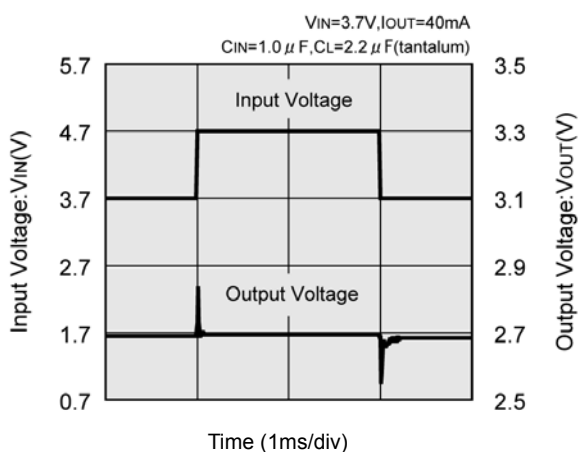

XC6201P332



XC6201P502



TYPICAL PERFORMANCE CHARACTERISTICS (Continued)

(8) Load Transient Response



■ TYPICAL PERFORMANCE CHARACTERISTICS (Continued)

(9) Ripple Rejection Rate

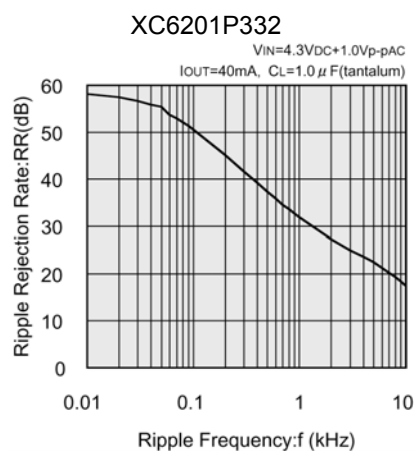

(10) Output Noise Density



PACKAGING INFORMATION

● SOT-25

Unit : mm



● SOT-25 Reference Pattern Layout

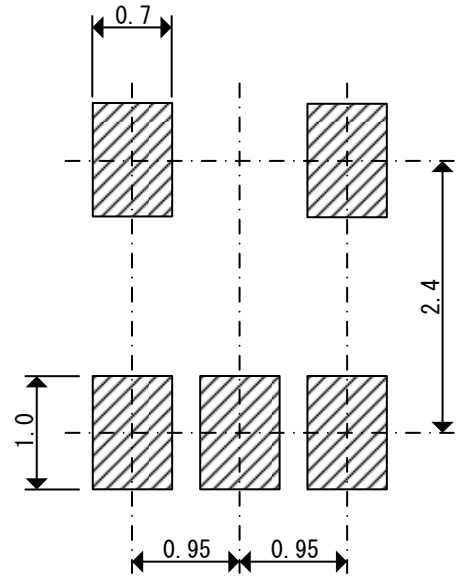

● SOT-89

Unit : mm

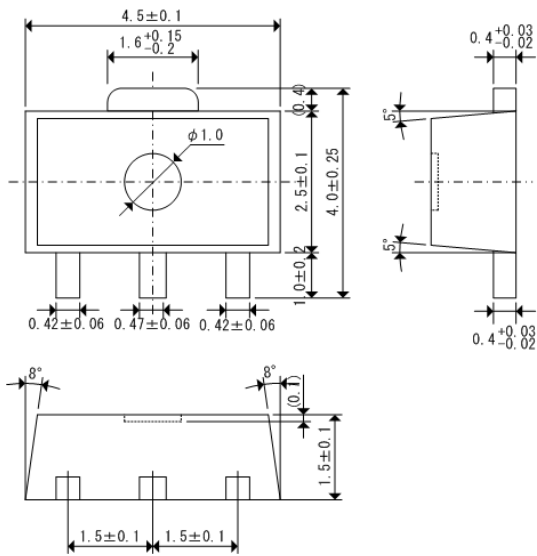

● SOT-89 Reference Pattern Layout

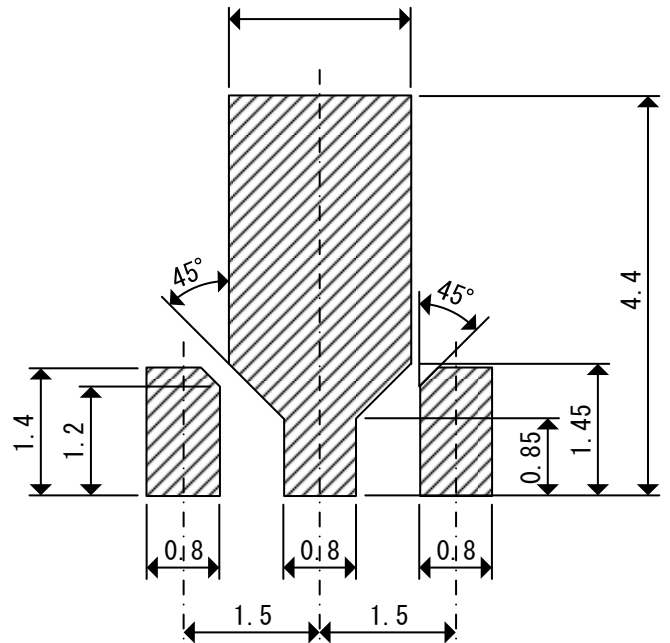

PACKAGING INFORMATION (Continued)

● USP-6B



● USP-6B Reference Pattern Layout



● USP-6B Reference Metal Mask Design



● SOT-25 Power Dissipation

Power dissipation data for the SOT-25 is shown in this page.

The value of power dissipation varies with the mount board conditions.

Please use this data as the reference data taken in the following condition.

1. Measurement Condition

Condition: Mount on a board

Ambient: Natural convection

Soldering: Lead (Pb) free

Board: Dimensions 40 x 40 mm

(1600 mm² in one side)

Copper (Cu) traces occupy 50% of the board area in top and back faces

Package heat-sink is tied to the copper traces (Board of SOT-26 is used.)

Material: Glass Epoxy (FR-4)

Thickness: 1.6mm

Through-hole: 4 x 0.8 Diameter



Evaluation Board (Unit: mm)

2. Power Dissipation vs. Ambient Temperature

Board Mount ($T_j \text{ max} = 125^\circ\text{C}$)

| Ambient Temperature ($^\circ\text{C}$) | Power Dissipation P_d (mW) | Thermal Resistance ($^\circ\text{C}/\text{W}$) |
|--|------------------------------|--|
| 25 | 600 | 166.67 |
| 85 | 240 | |



● **SOT-89 Power Dissipation**

Power dissipation data for the SOT-89 is shown in this page.

The value of power dissipation varies with the mount board conditions.

Please use this data as the reference data taken in the following condition.

1. Measurement Condition

Condition: Mount on a board

Ambient: Natural convection

Soldering: Lead (Pb) free

Board: Dimensions 40 x 40 mm

(1600 mm² in one side)

Copper (Cu) traces occupy 50% of the board

area in top and back faces

Package heat-sink is tied to the copper traces

Material: Glass Epoxy (FR-4)

Thickness: 1.6mm

Through-hole: 5 x 0.8 Diameter

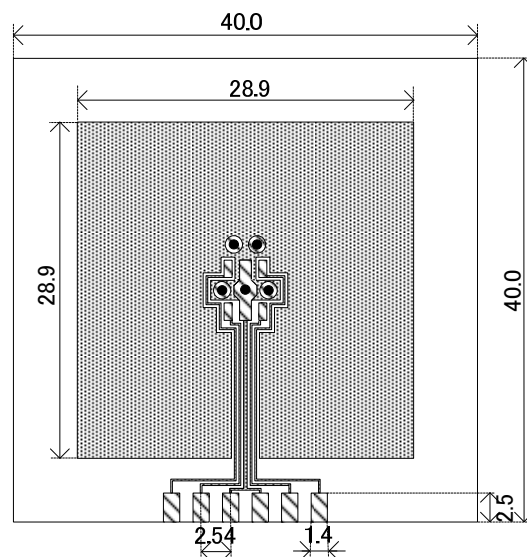

Evaluation Board (Unit : mm)

2. Power Dissipation vs. Ambient Temperature

Board Mount (T_j max = 125°C)

| Ambient Temperature (°C) | Power Dissipation Pd (mW) | Thermal Resistance (°C/W) |
|--------------------------|---------------------------|---------------------------|
| 25 | 1000 | 100.00 |
| 85 | 400 | |

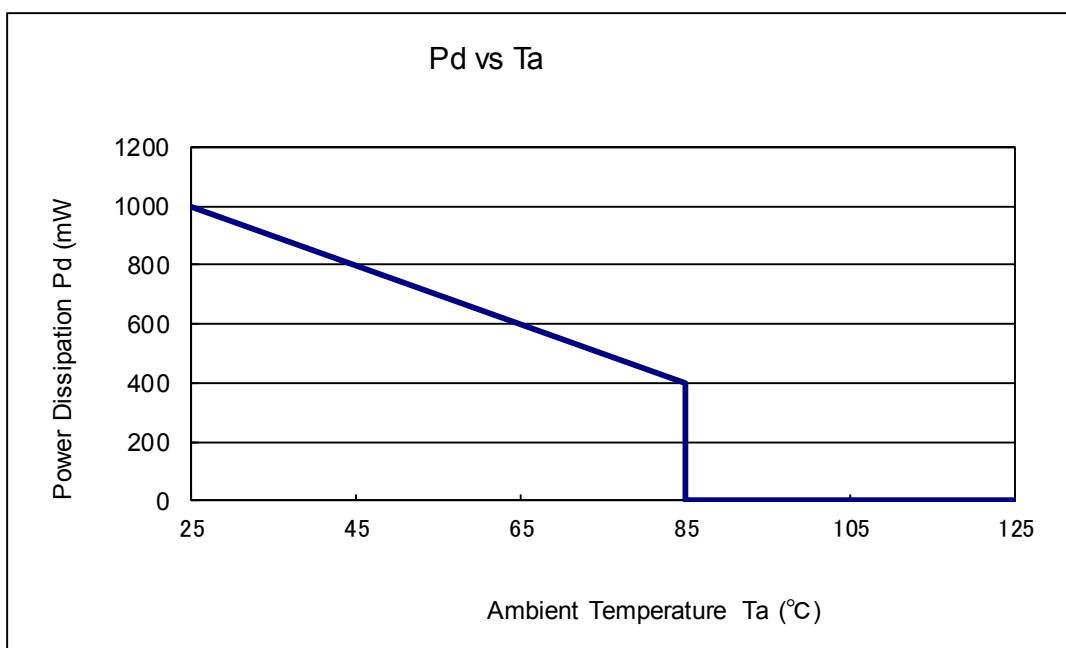

● USP-6B Power Dissipation

Power dissipation data for the USP-6B is shown in this page.

The value of power dissipation varies with the mount board conditions.

Please use this data as the reference data taken in the following condition.

1. Measurement Condition

Condition: Mount on a board

Ambient: Natural convection

Soldering: Lead (Pb) free

Board: Dimensions 40 x 40 mm

(1600 mm² in one side)

Copper (Cu) traces occupy 50% of the board

area in top and back faces

Package heat-sink is tied to the copper traces

Material: Glass Epoxy (FR-4)

Thickness: 1.6mm

Through-hole: 4 x 0.8 Diameter



Evaluation Board (Unit: mm)

2. Power Dissipation vs. Ambient Temperature

Board Mount ($T_j \text{ max} = 125^\circ\text{C}$)

| Ambient Temperature ($^\circ\text{C}$) | Power Dissipation P_d (mW) | Thermal Resistance ($^\circ\text{C}/\text{W}$) |
|--|------------------------------|--|
| 25 | 1000 | 100.00 |
| 85 | 400 | |

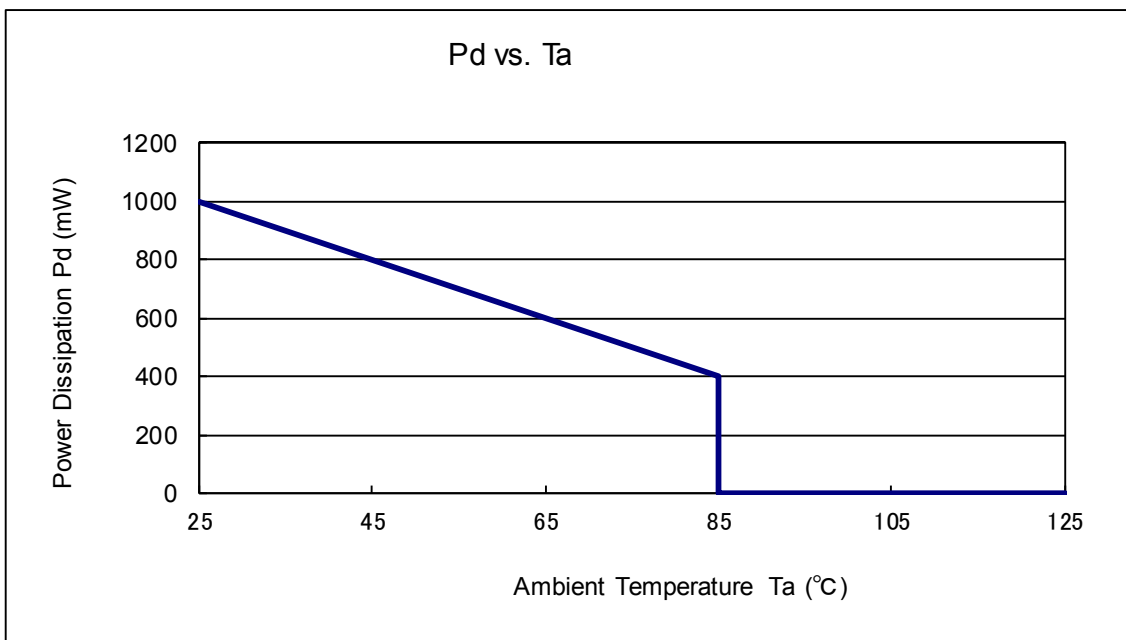

MARKING RULE

● SOT-89, SOT-25



SOT-89
(TOP VIEW)



SOT-25
(TOP VIEW)

① represents the product series

| MARK | PRODUCT SERIES |
|------|----------------|
| 1 | XC6201xxxxxx |

② represents type of regulator

| MARK | | PRODUCT SERIES |
|---------------------|---------------------|----------------|
| Voltage= 0.1 ~ 3.0V | Voltage= 3.1 ~ 6.0V | |
| 5 | 6 | XC6201Pxxxxx |
| 8 | 9 | XC6201TxxxPx |

③ represents output voltage

| MARK | OUTPUT VOLTAGE (V) | | | MARK | OUTPUT VOLTAGE (V) | | |
|------|--------------------|-----|---|------|--------------------|-----|---|
| 0 | — | 3.1 | — | F | 1.6 | 4.6 | — |
| 1 | — | 3.2 | — | H | 1.7 | 4.7 | — |
| 2 | — | 3.3 | — | K | 1.8 | 4.8 | — |
| 3 | — | 3.4 | — | L | 1.9 | 4.9 | — |
| 4 | — | 3.5 | — | M | 2.0 | 5.0 | — |
| 5 | — | 3.6 | — | N | 2.1 | 5.1 | — |
| 6 | — | 3.7 | — | P | 2.2 | 5.2 | — |
| 7 | — | 3.8 | — | R | 2.3 | 5.3 | — |
| 8 | — | 3.9 | — | S | 2.4 | 5.4 | — |
| 9 | — | 4.0 | — | T | 2.5 | 5.5 | — |
| A | — | 4.1 | — | U | 2.6 | 5.6 | — |
| B | — | 4.2 | — | V | 2.7 | 5.7 | — |
| C | 1.3 | 4.3 | — | X | 2.8 | 5.8 | — |
| D | 1.4 | 4.4 | — | Y | 2.9 | 5.9 | — |
| E | 1.5 | 4.5 | — | Z | 3.0 | 6.0 | — |

④ represents assembly lot number

0 to 9, A to Z repeated (G, I, J, O, Q, W excluded)

MARKING RULE (Continued)

● USP-6B

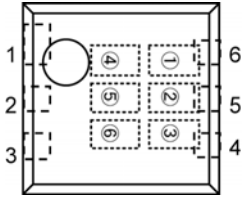

USP-6B
(TOP VIEW)

①② represents product series

③ represents type of regulator

| MARK | TYPE | PRODUCT SERIES |
|------|----------------------------|----------------|
| P | 3pin Regulator | XC6201PxxxDx |
| T | V _{IN} =7V(Rated) | XC6201TxxxDx |

④⑤ represents output voltage

| MARK | | VOLTAGE (V) | PRODUCT SERIES |
|------|---|-------------|----------------|
| ④ | ⑤ | | |
| 3 | 3 | 3.3 | XC6201x33xDx |
| 5 | 0 | 5.0 | XC6201x50xDx |



⑥ represents assembly lot number
0 to 9, A to Z repeated (G, I, J, O, Q, W excluded)
Note: No character inversion used.

1. The product and product specifications contained herein are subject to change without notice to improve performance characteristics. Consult us, or our representatives before use, to confirm that the information in this datasheet is up to date.
2. The information in this datasheet is intended to illustrate the operation and characteristics of our products. We neither make warranties or representations with respect to the accuracy or completeness of the information contained in this datasheet nor grant any license to any intellectual property rights of ours or any third party concerning with the information in this datasheet.
3. Applicable export control laws and regulations should be complied and the procedures required by such laws and regulations should also be followed, when the product or any information contained in this datasheet is exported.
4. The product is neither intended nor warranted for use in equipment of systems which require extremely high levels of quality and/or reliability and/or a malfunction or failure which may cause loss of human life, bodily injury, serious property damage including but not limited to devices or equipment used in 1) nuclear facilities, 2) aerospace industry, 3) medical facilities, 4) automobile industry and other transportation industry and 5) safety devices and safety equipment to control combustions and explosions. Do not use the product for the above use unless agreed by us in writing in advance.
5. Although we make continuous efforts to improve the quality and reliability of our products; nevertheless Semiconductors are likely to fail with a certain probability. So in order to prevent personal injury and/or property damage resulting from such failure, customers are required to incorporate adequate safety measures in their designs, such as system fail safes, redundancy and fire prevention features.
6. Our products are not designed to be Radiation-resistant.
7. Please use the product listed in this datasheet within the specified ranges.
8. We assume no responsibility for damage or loss due to abnormal use.
9. All rights reserved. No part of this datasheet may be copied or reproduced unless agreed by Torex Semiconductor Ltd in writing in advance.

TOREX SEMICONDUCTOR LTD.

Looking for pricing, stock, or lifecycle information?

Click below to explore more details on WIN SOURCE:

-  [View XC6201P392MR on WIN SOURCE](#)
-  [Torex Semiconductor Ltd Information](#)

Optimize Your Supply Chain with WIN SOURCE Solutions

-  Global Sourcing Solution
-  Obsolete Management
-  Cost Control Management
-  Shortage Management
-  Alternative Solution
-  Excess Inventory Management