



**THE DATASHEET OF
XC6202P432PRN**



High Voltage Positive Voltage Regulators

■ GENERAL DESCRIPTION

The XC6202 series are highly precise, low power consumption, high voltage input, positive voltage regulators manufactured using CMOS and laser trimming technologies. The XC6202 consists of a current limiter circuit, a driver transistor, a precision reference voltage and an error correction circuit.

Output voltage is selectable in 0.1V steps from 1.8V ~ 18V. The series are also compatible with low ESR ceramic capacitors which give added output stability.

Since the current limiter circuit is built-in, the IC is protected against overshoot currents at such times of output shorts etc.

SOT-23, SOT-89, SOT-223 and USP-6B packages are available.

■ APPLICATIONS

- Multi-function power supplies
- Note PCs / Tablet PCs
- Digital still cameras / Camcorders
- Reference voltage sources

■ FEATURES

| | |
|---|---|
| Maximum Output Current | : 150mA (within Pd) |
| Maximum Operational Voltage | : 20V |
| Output Voltage Range | : 1.8V ~ 18V (0.1V increments) |
| Highly Accurate | : $\pm 2\%$ |
| Low Power Consumption | : 10 μ A (TYP.) |
| Line Regulation | : 0.01% / V (TYP.) |
| Dropout Voltage | : 200mV @ 30mA 670mV@100mA |
| Operational Temperature Range | : -40°C ~ 85°C |
| Low ESR Capacitor Compatible | : Ceramic capacitor |
| Current Limiter Circuit Built-In | |
| Packages | : SOT-23 SOT-89 SOT-223 USP-6B |
| Environmentally Friendly | : EU RoHS Compliant, Pb Free |

■ TYPICAL APPLICATION CIRCUIT

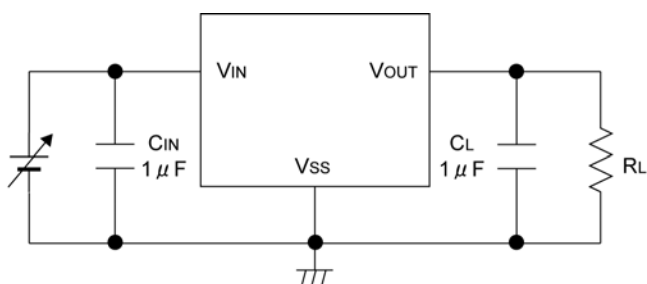

■ TYPICAL PERFORMANCE CHARACTERISTICS



PIN CONFIGURATION



SOT-23
(TOP VIEW)



SOT-89
(TOP VIEW)



SOT-223
(TOP VIEW)

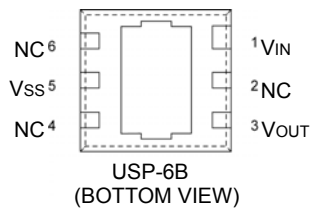

*The dissipation pad for the USP-6B package should be solder-plated in recommended mount pattern and metal masking so as to enhance mounting strength and heat release. If the pad needs to be connected to other pins, it should be connected to the VSS (No.5) pin.

PIN ASSIGNMENT

| PIN NUMBER | | | PIN NAME | FUNCTIONS |
|------------|-------------------|---------|----------|---------------|
| SOT-23 | SOT-89 SOT-223 | USP-6B | | |
| 1 | 1 | 3 | VOUT | Output |
| 3 | 2 | 5 | Vss | Ground |
| 2 | 3 | 1 | VIN | Power Input |
| — | — | 2, 4, 6 | NC | No connection |

■ PRODUCT CLASSIFICATION

● Ordering Information

XC6202P①②③④⑤-⑥^(*)

| DESIGNATOR | ITEM | SYMBOL | DESCRIPTION |
|---------------------|--------------------------|---------|--|
| ①② | Output Voltage | 18 ~ J0 | : For the voltage above 10V, see the example 10=A, 11=B 12=C, 13=D, 14=E, 15=F, 16=G, 17=H, 18=J e.g. V _{OUT} = 3.0V → ①:3, ②:0 V _{OUT} = 12V → ①:C, ②:0 V _{OUT} = 15V → ①:F, ②:0 |
| ③ | Accuracy | 2 | : ±2% |
| ④⑤-⑥ ^(*) | Packages (Order Unit) | MR | : SOT-23 (3,000pcs/Reel) |
| | | MR-G | : SOT-23 (3,000pcs/Reel) |
| | | PR | : SOT-89 (1,000pcs/Reel) |
| | | PR-G | : SOT-89 (1,000pcs/Reel) |
| | | FR | : SOT-223 (1,000pcs/Reel) |
| | | FR-G | : SOT-223 (1,000pcs/Reel) |
| | | DR | : USP-6B (3,000pcs/Reel) |
| | | DR-G | : USP-6B (3,000pcs/Reel) |

^(*) The "-G" suffix denotes Halogen and Antimony free as well as being fully EU RoHS compliant.

■ BLOCK DIAGRAM



■ ABSOLUTE MAXIMUM RATINGS

Ta = 25°C

| PARAMETER | SYMBOL | RATINGS | UNITS |
|-------------------------------|------------------|---|---------|
| Input Voltage | V _{IN} | 22.0 | V |
| Output Current | I _{OUT} | 500 | mA |
| Output Voltage | V _{OUT} | V _{SS} -0.3 ~ V _{IN} +0.3 | V |
| Power Dissipation | SOT-23 | P _d | 250 |
| | SOT-89 | | 500 |
| | USP-6B | | 120 |
| | SOT-223 | | 1,200 * |
| Operating Ambient Temperature | T _{opr} | -40~+85 | °C |
| Storage Temperature | T _{stg} | -55~+125 | °C |

■ ELECTRICAL CHARACTERISTICS

XC6202P182 $V_{OUT(T)}=1.8V$ (*1)

$T_a=25^{\circ}C$

| PARAMETER | SYMBOL | CONDITIONS | MIN. | TYP. | MAX. | UNITS | CIRCUIT |
|--|---|--|-------|-----------|-------|------------------|---------|
| Output Voltage | $V_{OUT(E)}$ (*2) | $V_{IN}=2.8V$ $I_{OUT}=30mA$ | 1.764 | 1.800 | 1.836 | V | ② |
| Maximum Output Current | I_{OUTmax} | $V_{IN}=2.8V$ $V_{OUT} \geq V_{OUT(E)} \times 0.9$ | 60 | - | - | mA | ② |
| Load Regulation | ΔV_{OUT} | $V_{IN}=2.8V$ $1mA \leq I_{OUT} \leq 60mA$ | - | 10 | 80 | mV | ② |
| Dropout Voltage(*3) | Vdif1 | $I_{OUT}=30mA$ | - | 340 | 470 | mV | ② |
| | Vdif2 | $I_{OUT}=100mA$ | - | 1000 | 1500 | | |
| Supply Current | I_{SS} | $V_{IN}=2.8V$ | - | 10 | 24 | μA | ① |
| Line Regulation | $\frac{\Delta V_{OUT}}{(\Delta V_{IN} \cdot \Delta V_{OUT})}$ | $I_{OUT}=1mA$ $2.8V \leq V_{IN} \leq 20V$ | - | 0.01 | 0.20 | %/V | ② |
| Input Voltage | V_{IN} | | - | - | 20 | V | - |
| Output Voltage Temperature Characteristics | $\frac{\Delta V_{OUT}}{(\Delta T_a \cdot \Delta V_{OUT})}$ | $I_{OUT}=30mA$ $-40^{\circ}C \leq T_a \leq 85^{\circ}C$ | - | ± 100 | - | ppm/ $^{\circ}C$ | ② |
| Short-circuit Current | I_{short} | $V_{IN}=3.8V$ | - | 40 | - | mA | ② |

XC6202P332 $V_{OUT(T)}=3.3V$ (*1)

$T_a=25^{\circ}C$

| PARAMETER | SYMBOL | CONDITIONS | MIN. | TYP. | MAX. | UNITS | CIRCUIT |
|--|---|--|-------|-----------|-------|------------------|---------|
| Output Voltage | $V_{OUT(E)}$ (*2) | $V_{IN}=4.3V$ $I_{OUT}=30mA$ | 3.234 | 3.300 | 3.366 | V | ② |
| Maximum Output Current | I_{OUTmax} | $V_{IN}=4.3V$ $V_{OUT} \geq V_{OUT(E)} \times 0.9$ | 150 | - | - | mA | ② |
| Load Regulation | ΔV_{OUT} | $V_{IN}=4.3V$ $1mA \leq I_{OUT} \leq 100mA$ | - | 25 | 90 | mV | ② |
| Dropout Voltage(*3) | Vdif1 | $I_{OUT}=30mA$ | - | 200 | 280 | mV | ② |
| | Vdif2 | $I_{OUT}=100mA$ | - | 670 | 900 | | |
| Supply Current | I_{SS} | $V_{IN}=4.3V$ | - | 10 | 24 | μA | ① |
| Line Regulation | $\frac{\Delta V_{OUT}}{(\Delta V_{IN} \cdot \Delta V_{OUT})}$ | $I_{OUT}=1mA$ $4.3V \leq V_{IN} \leq 20V$ | - | 0.01 | 0.20 | %/V | ② |
| Input Voltage | V_{IN} | | - | - | 20 | V | - |
| Output Voltage Temperature Characteristics | $\frac{\Delta V_{OUT}}{(\Delta T_a \cdot \Delta V_{OUT})}$ | $I_{OUT}=30mA$ $-40^{\circ}C \leq T_a \leq 85^{\circ}C$ | - | ± 100 | - | ppm/ $^{\circ}C$ | ② |
| Short-circuit Current | I_{short} | $V_{IN}=5.3V$ | - | 40 | - | mA | ② |

ELECTRICAL CHARACTERISTICS (Continued)

XC6202P502

$V_{OUT(T)}=5.0V$ (*1)

$T_a=25^\circ C$

| PARAMETER | SYMBOL | CONDITIONS | MIN. | TYP. | MAX. | UNITS | CIRCUIT |
|--|---|--|-------|-----------|------|-----------------|---------|
| Output Voltage | $V_{OUT(E)}$ (*2) | $V_{IN}=6V$ $I_{OUT}=30mA$ | 4.900 | 5.000 | 5100 | V | ② |
| Maximum Output Current | I_{OUTmax} | $V_{IN}=6V$ $V_{OUT} \geq V_{OUT(E)} \times 0.9$ | 200 | - | - | mA | ② |
| Load Regulation | ΔV_{OUT} | $V_{IN}=6V$ $1mA \leq I_{OUT} \leq 100mA$ | - | 30 | 100 | mV | ② |
| Dropout Voltage (*3) | V_{dif1} | $I_{OUT}=30mA$ | - | 130 | 190 | mV | ② |
| | V_{dif2} | $I_{OUT}=100mA$ | - | 440 | 550 | | |
| Supply Current | I_{SS} | $V_{IN}=6V$ | - | 10 | 24 | μA | ① |
| Line Regulation | $\frac{\Delta V_{OUT}}{(\Delta V_{IN} \cdot \Delta V_{OUT})}$ | $I_{OUT}=1mA$ $6V \leq V_{IN} \leq 20V$ | - | 0.01 | 0.20 | %/V | ② |
| Input Voltage | V_{IN} | | - | - | 20 | V | - |
| Output Voltage Temperature Characteristics | $\frac{\Delta V_{OUT}}{(\Delta T_a \cdot \Delta V_{OUT})}$ | $I_{OUT}=30mA$ $-40^\circ C \leq T_a \leq 85^\circ C$ | - | ± 100 | - | ppm/ $^\circ C$ | ② |
| Short-circuit Current | I_{short} | $V_{IN}=7V$ | - | 40 | - | mA | ② |

XC6202PC02

$V_{OUT(T)}=12V$ (*1)

$T_a=25^\circ C$

| PARAMETER | SYMBOL | CONDITIONS | MIN. | TYP. | MAX. | UNITS | CIRCUIT |
|--|---|--|--------|-----------|--------|-----------------|---------|
| Output Voltage | $V_{OUT(E)}$ (*2) | $V_{IN}=13V$ $I_{OUT}=30mA$ | 11.760 | 12.000 | 12.240 | V | ② |
| Maximum Output Current | I_{OUTmax} | $V_{IN}=13V$ $V_{OUT} \geq V_{OUT(E)} \times 0.9$ | 200 | - | - | mA | ② |
| Load Regulation | ΔV_{OUT} | $V_{IN}=13V$ $1mA \leq I_{OUT} \leq 100mA$ | - | 60 | 230 | mV | ② |
| Dropout Voltage (*3) | V_{dif1} | $I_{OUT}=30mA$ | - | 90 | 150 | mV | ② |
| | V_{dif2} | $I_{OUT}=100mA$ | - | 290 | 380 | | |
| Supply Current | I_{SS} | $V_{IN}=13V$ | - | 12 | 28 | μA | ① |
| Line Regulation | $\frac{\Delta V_{OUT}}{(\Delta V_{IN} \cdot \Delta V_{OUT})}$ | $I_{OUT}=1mA$ $13V \leq V_{IN} \leq 20V$ | - | 0.01 | 0.20 | %/V | ② |
| Input Voltage | V_{IN} | | - | - | 20 | V | - |
| Output Voltage Temperature Characteristics | $\frac{\Delta V_{OUT}}{(\Delta T_a \cdot \Delta V_{OUT})}$ | $I_{OUT}=30mA$ $-40^\circ C \leq T_a \leq 85^\circ C$ | - | ± 100 | - | ppm/ $^\circ C$ | ② |
| Short-circuit Current | I_{short} | $V_{IN}=14V$ | - | 40 | - | mA | ② |

■ ELECTRICAL CHARACTERISTICS (Continued)

XC6202PJ02

$V_{OUT(T)}=18V$ (*1)

$T_a=25^\circ C$

| PARAMETER | SYMBOL | CONDITIONS | MIN. | TYP. | MAX. | UNITS | CIRCUIT |
|--|---|--|--------|-----------|--------|-----------------|---------|
| Output Voltage | $V_{OUT(E)}$ (*2) | $V_{IN}=19V$ $I_{OUT}=30mA$ | 17.640 | 18.000 | 18.360 | V | ② |
| Maximum Output Current | I_{OUTmax} | $V_{IN}=19V$ $V_{OUT} \geq V_{OUT(E)} \times 0.9$ | 200 | - | - | mA | ② |
| Load Regulation | ΔV_{OUT} | $V_{IN}=19V$ $1mA \leq I_{OUT} \leq 100mA$ | - | 120 | 380 | mV | ② |
| Dropout Voltage (*3) | Vdif1 | $I_{OUT}=30mA$ | - | 80 | 150 | mV | ② |
| | Vdif2 | $I_{OUT}=100mA$ | - | 280 | 380 | | |
| Supply Current | I_{SS} | $V_{IN}=19V$ | - | 15 | 30 | μA | ① |
| Line Regulation | $\frac{\Delta V_{OUT}}{(\Delta V_{IN} \cdot \Delta V_{OUT})}$ | $I_{OUT}=1mA$ $19V \leq V_{IN} \leq 20V$ | - | 0.01 | 0.20 | %/V | ② |
| Input Voltage | V_{IN} | | - | - | 20 | V | - |
| Output Voltage Temperature Characteristics | $\frac{\Delta V_{OUT}}{(\Delta T_a \cdot \Delta V_{OUT})}$ | $I_{OUT}=30mA$ $-40^\circ C \leq T_a \leq 85^\circ C$ | - | ± 100 | - | ppm/ $^\circ C$ | ② |
| Short-circuit Current | I_{short} | $V_{IN}=20V$ | - | 40 | - | mA | ② |

*1. $V_{OUT(T)}$ = Specified output voltage.

*2. $V_{OUT(E)}$ = Effective output voltage (i.e. the output voltage when " $V_{OUT(T)}+1.0V$ " is provided at the V_{IN} pin while maintaining certain I_{OUT} value).

*3. $V_{dif} = \{V_{IN1}^{(*5)} - V_{OUT1}^{(*4)}\}$

*4. V_{OUT1} = A voltage equal to 98% of the output voltage when " $V_{OUT(T)} + 1.0V$ " is input.

*5. V_{IN1} = The input voltage when V_{OUT1} is output following a gradual decrease in the input voltage.

■ TEST CIRCUITS

CIRCUIT ①



CIRCUIT ②



TYPICAL PERFORMANCE CHARACTERISTICS

●XC6202P182

(1) Output Voltage vs. Output Current

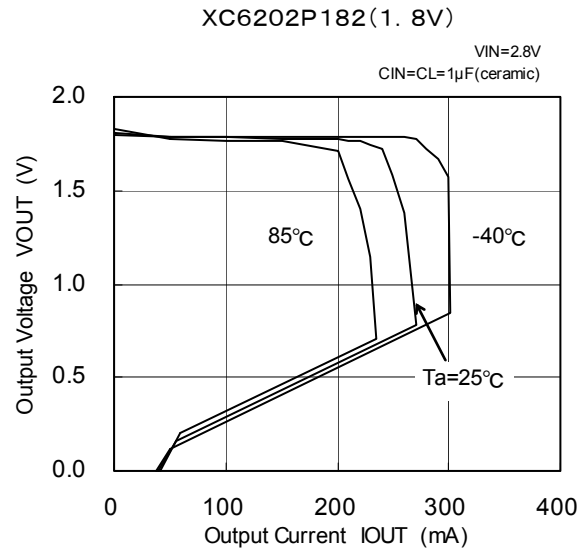
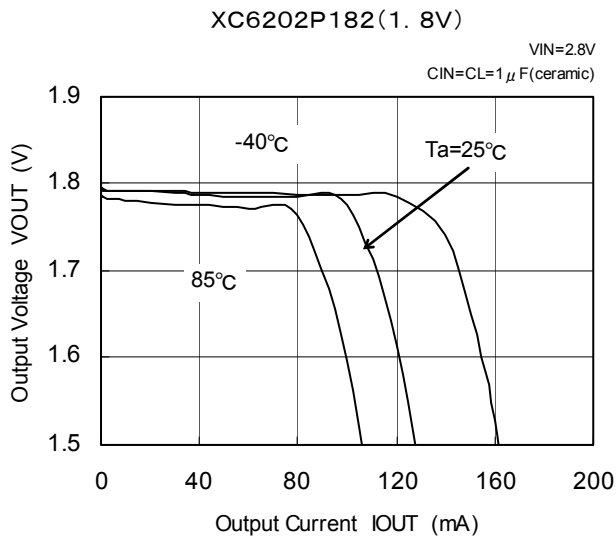

(2) Output Voltage vs. Input Voltage

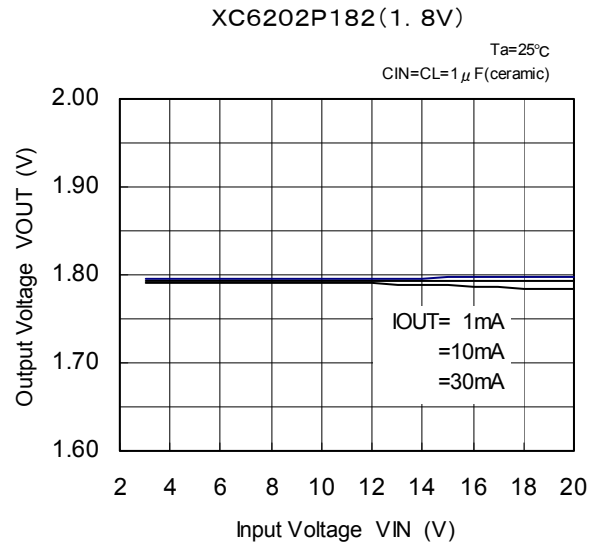
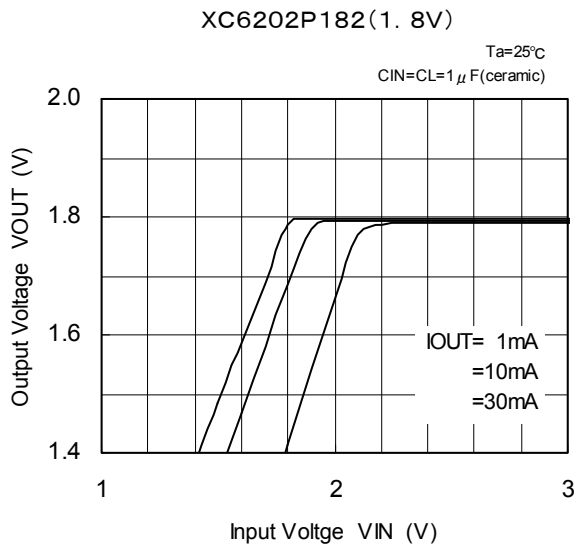

(3) Dropout Voltage vs. Output Current



■ TYPICAL PERFORMANCE CHARACTERISTICS (Continued)

● XC6202P182 (Continued)

(4) Supply Current vs. Input Voltage

XC6202P182 (1.8V)



XC6202P182 (1.8V)



(5) Output Voltage vs. Ambient Temperature

XC6202P182 (1.8V)



(6) Supply Current vs. Ambient Temperature

XC6202P182 (1.8V)



TYPICAL PERFORMANCE CHARACTERISTICS (Continued)

XC6202P182 (Continued)

(7) Input Transient Response 1

XC6202P182(1.8V)

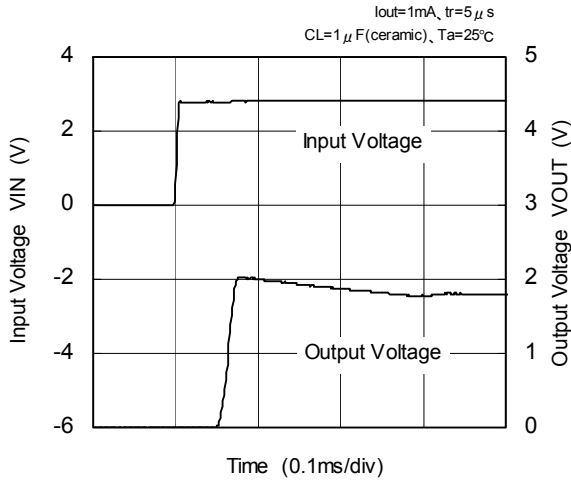

XC6202P182(1.8V)

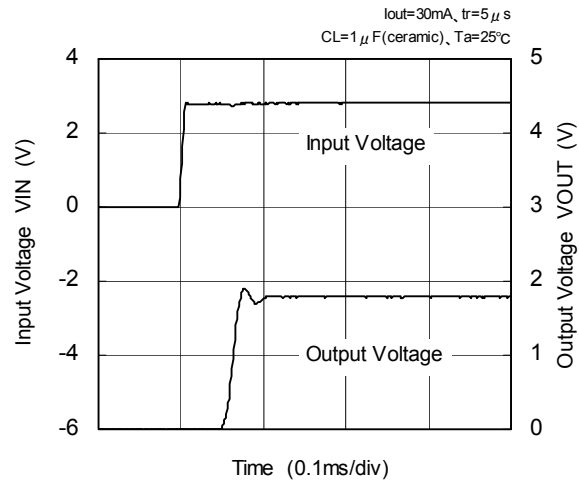

(8) Input Transient Response 2

XC6202P182(1.8V)

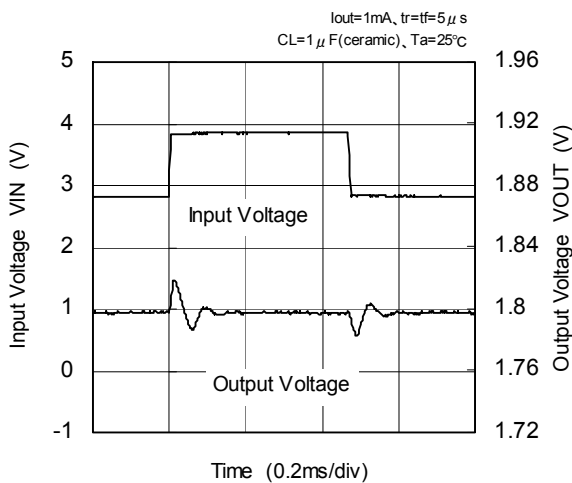

XC6202P182(1.8V)

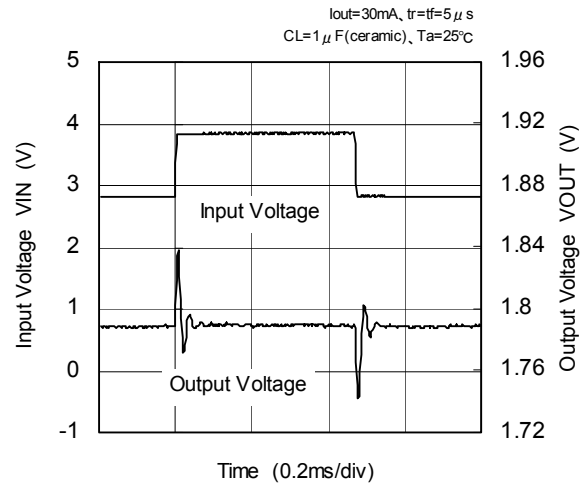

(9) Load Transient Response

XC6202P182(1.8V)

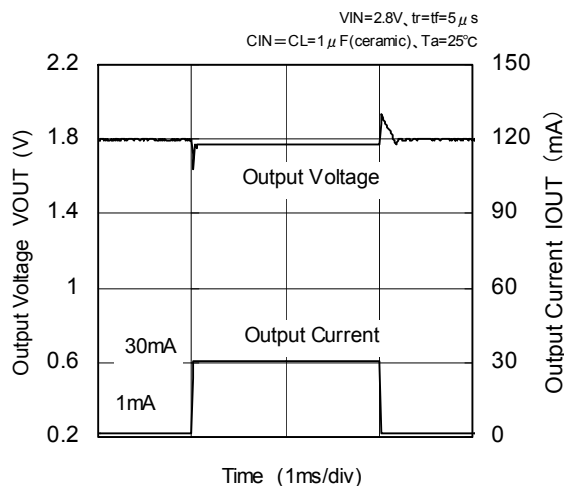

■ TYPICAL PERFORMANCE CHARACTERISTICS (Continued)

● XC6202P182 (Continued)

(10) Ripple Rejection Rate



TYPICAL PERFORMANCE CHARACTERISTICS (Continued)

●XC6202P332

(1) Output Voltage vs. Output Current

XC6202P332 (3.3V)

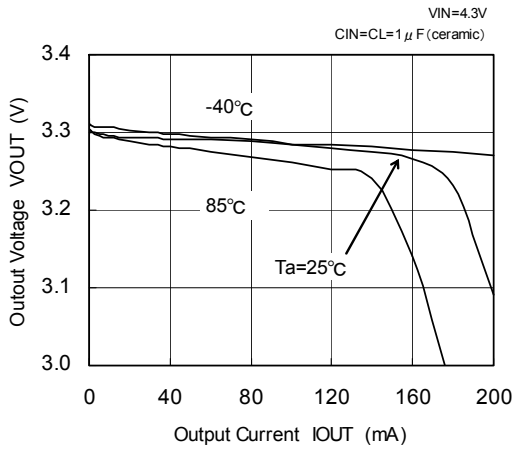

XC6202P332 (3.3V)

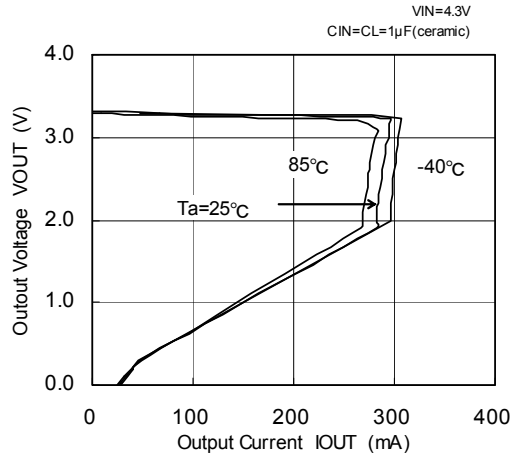

(2) Output Voltage vs. Input Voltage

XC6202P332 (3.3V)

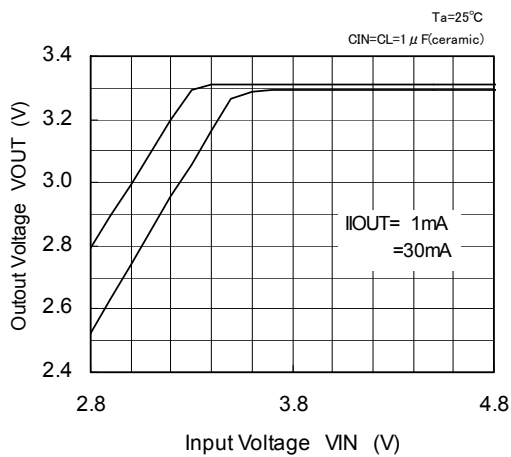

XC6202P332 (3.3V)



(3) Dropout Voltage vs. Output Current

XC6202P332 (3.3V)

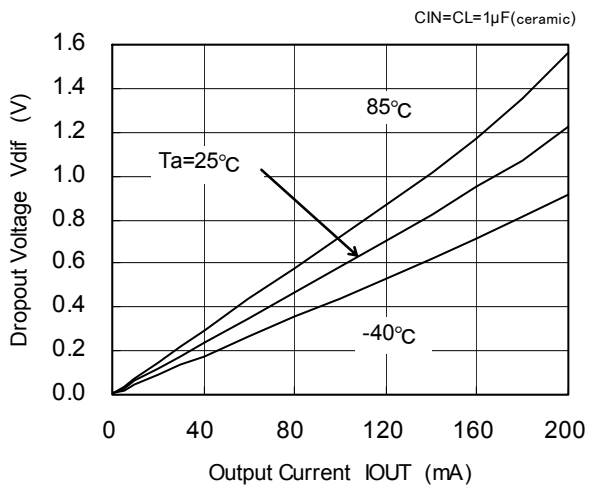

■ TYPICAL PERFORMANCE CHARACTERISTICS (Continued)

● XC6202P332 (Continued)

(4) Supply Current vs. Input Voltage

XC6202P332 (3.3V)



XC6202P332 (3.3V)



(5) Output Voltage vs. Ambient Temperature

XC6202P332 (3.3V)



(6) Supply Current vs. Ambient Temperature

XC6202P332 (3.3V)

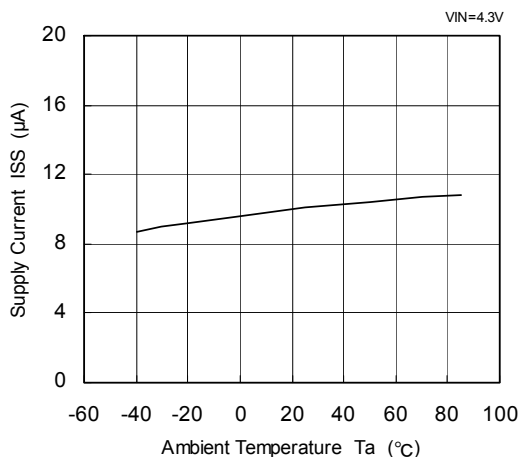

TYPICAL PERFORMANCE CHARACTERISTICS (Continued)

●XC6202P332 (Continued)

(7) Input Transient Response 1

XC6202P332 (3.3V)



(8) Input Transient Response 2

XC6202P332 (3.3V)



XC6202P332 (3.3V)



(9) Load Transient Response

XC6202P332 (3.3V)



TYPICAL PERFORMANCE CHARACTERISTICS (Continued)

●XC6202P332 (Continued)

(10) Ripple Rejection Rate

XC6202P332 (3.3V)

VIN=4.3VDC+1Vp-pAC

IOUT=0.1mA, CL=1μF(ceramic), Ta=25°C



XC6202P332 (3.3V)

VIN=4.3VDC+1Vp-pAC

IOUT=1mA, CL=1μF(ceramic), Ta=25°C



XC6202P332 (3.3V)

VIN=4.3VDC+1Vp-pAC

IOUT=10mA, CL=1μF(ceramic), Ta=25°C



XC6202P332 (3.3V)

VIN=4.3VDC+1Vp-pAC

IOUT=30mA, CL=1μF(ceramic), Ta=25°C



XC6202P332 (3.3V)

VIN=4.3VDC+1Vp-pAC

IOUT=50mA, CL=1μF(ceramic), Ta=25°C



TYPICAL PERFORMANCE CHARACTERISTICS (Continued)

●XC6202P502

(1) Output Voltage vs. Output Current

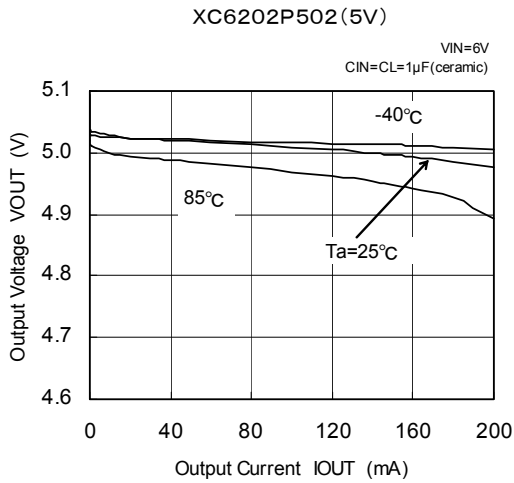

(2) Output Voltage vs. Input Voltage



(3) Dropout Voltage vs. Output Current



TYPICAL PERFORMANCE CHARACTERISTICS (Continued)

●XC6202P502 (Continued)

(4) Supply Current vs. Input Voltage

XC6202P502 (5V)

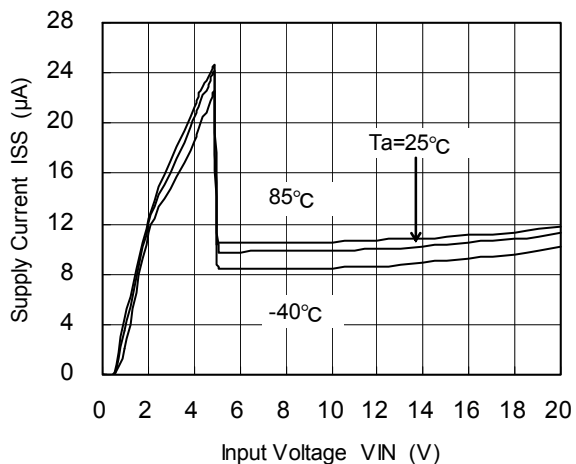

XC6202P502 (5V)

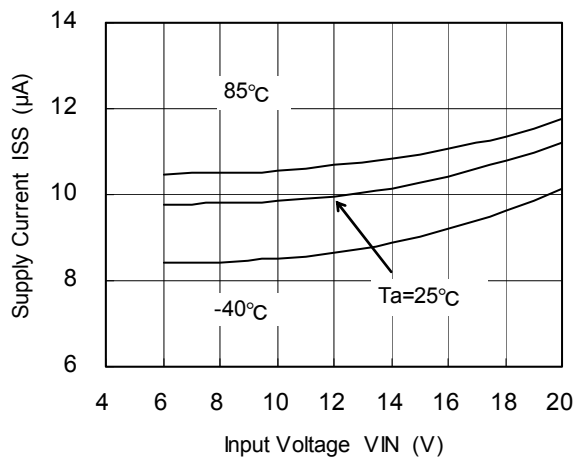

(5) Output Voltage vs. Ambient Temperature

XC6202P502 (5V)

VIN=6V
CIN=CL=1µF(ceramic)

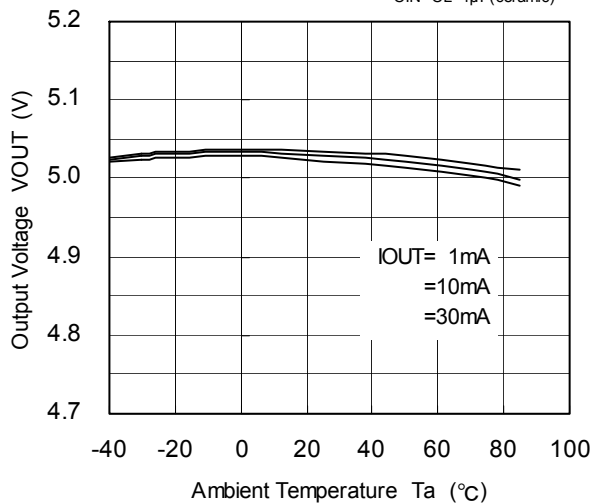

(6) Supply Current vs. Ambient Temperature

XC6202P502 (5V)

VIN=6V

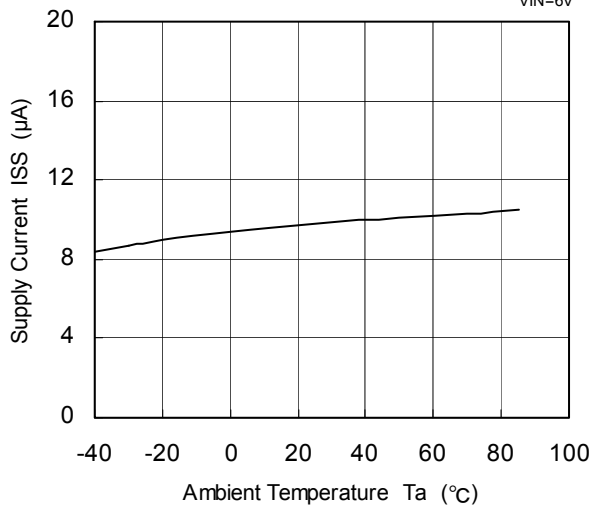

TYPICAL PERFORMANCE CHARACTERISTICS (Continued)

●XC6202P502 (Continued)

(7) Input Transient Response 1

XC6202P502 (5V)



XC6202P502 (5V)



(8) Input Transient Response 2

XC6202P502 (5V)



XC6202P502 (5V)



(9) Load Transient Response

XC6202P502 (5V)



■ TYPICAL PERFORMANCE CHARACTERISTICS (Continued)

● XC6202P502 (Continued)

(10) Ripple Rejection Rate



TYPICAL PERFORMANCE CHARACTERISTICS (Continued)

●XC6202PC02

(1) Output Voltage vs. Output Current

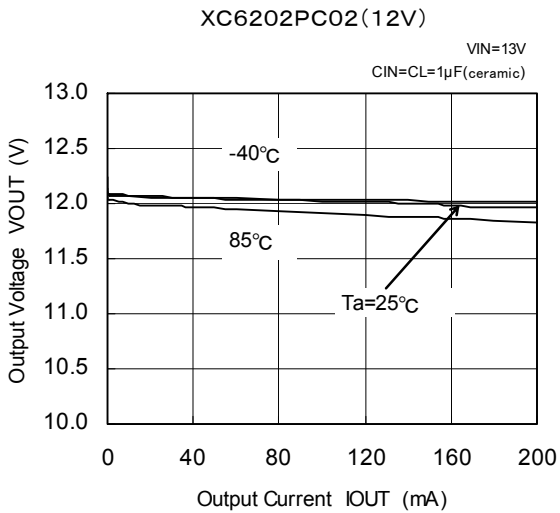

(2) Output Voltage vs. Input Voltage



(3) Dropout Voltage vs. Output Current

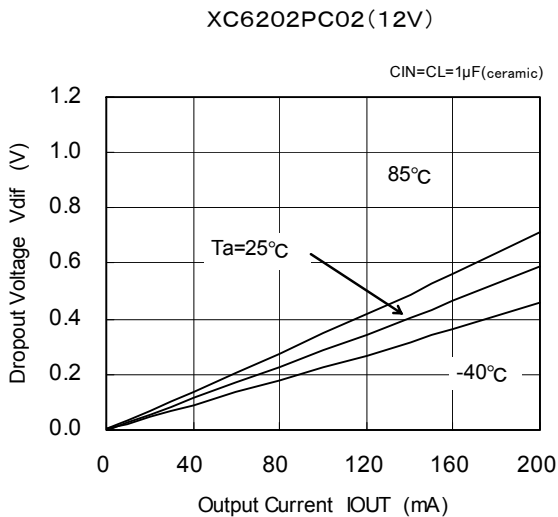

■ TYPICAL PERFORMANCE CHARACTERISTICS (Continued)

● XC6202PC02 (Continued)

(4) Supply Current vs. Input Voltage

XC6202PC02(12V)



XC6202PC02(12V)



(5) Output Voltage vs. Ambient Temperature

XC6202PC02(12V)



(6) Supply Current vs. Ambient Temperature

XC6202PC02(12V)



TYPICAL PERFORMANCE CHARACTERISTICS (Continued)

●XC6202PC02 (Continued)

(7) Input Transient Response 1



(8) Input Transient Response 2



(9) Load Transient Response



■ TYPICAL PERFORMANCE CHARACTERISTICS (Continued)

● XC6202PC02 (Continued)

(10) Ripple Rejection Rate



TYPICAL PERFORMANCE CHARACTERISTICS (Continued)

●XC6202PJ02

(1) Output Voltage vs. Output Current



(2) Output Voltage vs. Input Voltage



(3) Dropout Voltage vs. Output Current

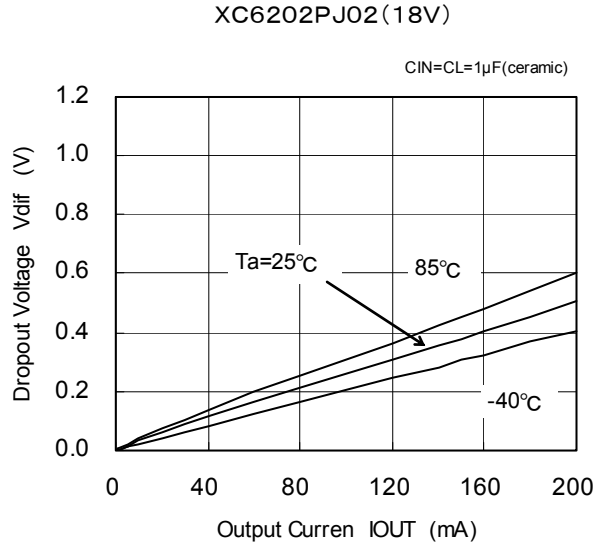

(4) Supply Current vs. Input Voltage

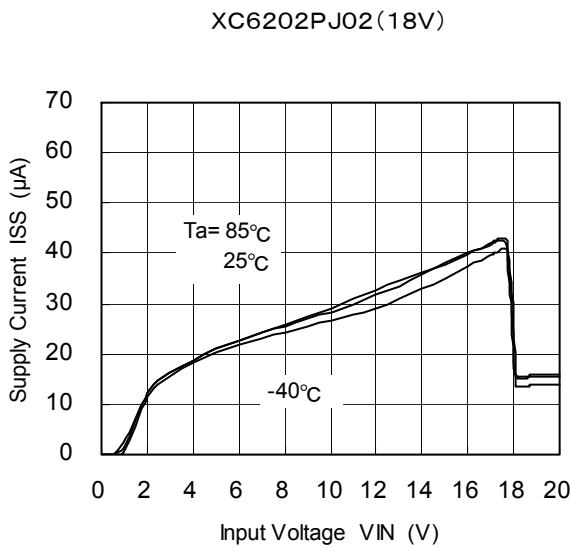

(5) Output Voltage vs. Ambient Temperature



■ TYPICAL PERFORMANCE CHARACTERISTICS (Continued)

● XC6202PJ02 (Continued)

(6) Supply Current vs. Ambient Temperature
XC6202PJ02(18V)



(7) Input Transient Response 1

XC6202PJ02(18V)

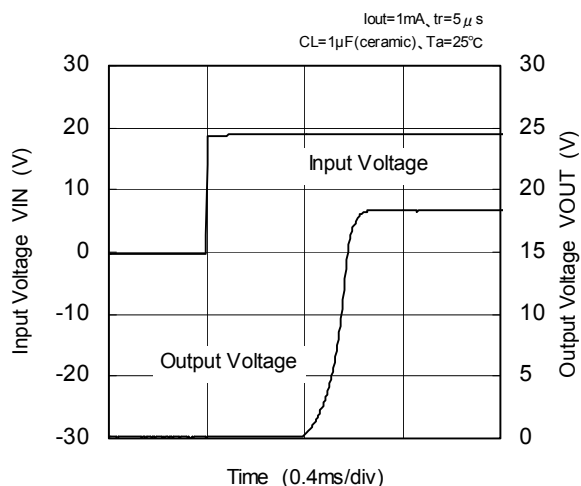

XC6202PJ02(18V)

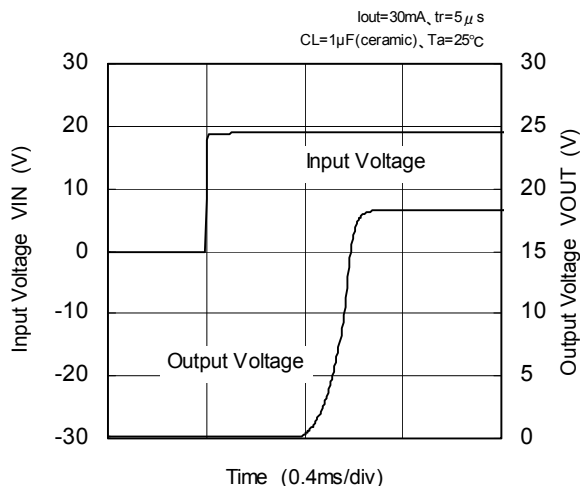

(8) Input Transient Response 2

XC6202PJ02(18V)

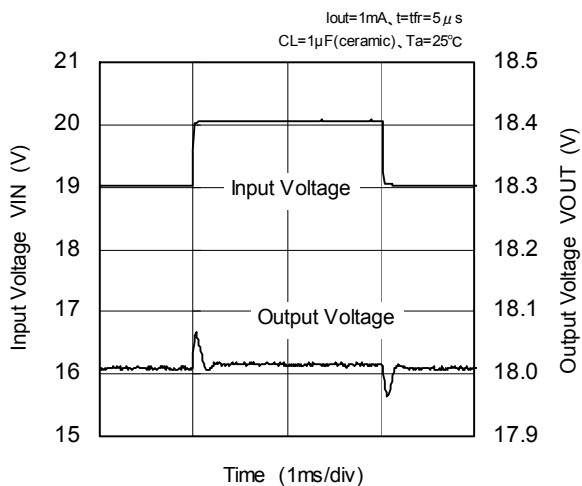

XC6202PJ02(18V)

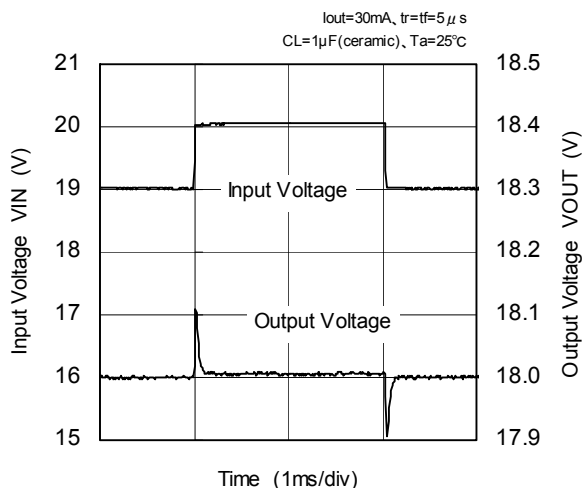

TYPICAL PERFORMANCE CHARACTERISTICS (Continued)

●XC6202PJ02 (Continued)

(9) Load Transient Response

XC6202PJ02(18V)

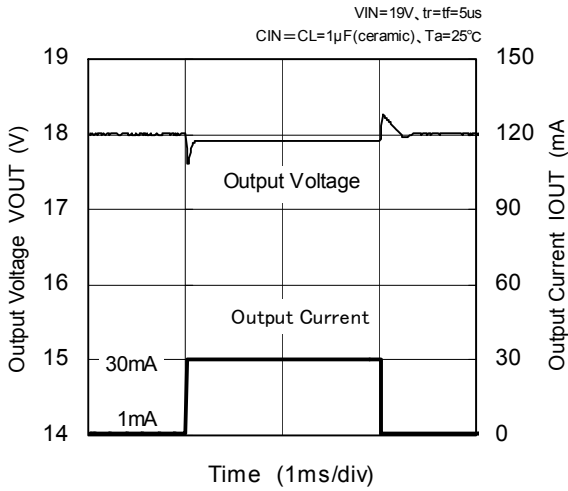

(10) Ripple Rejection Rate

XC6202PJ02(18V)



XC6202PJ02(18V)



XC6202PJ02(18V)



■ PACKAGING INFORMATION

● SOT-23

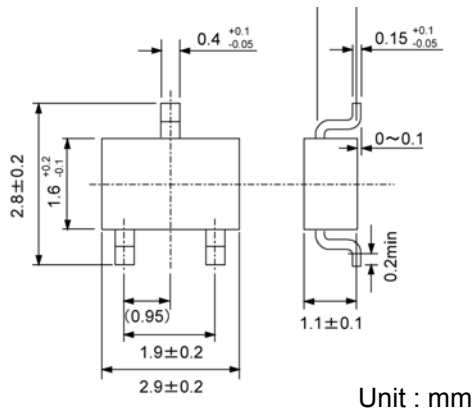

● SOT-89

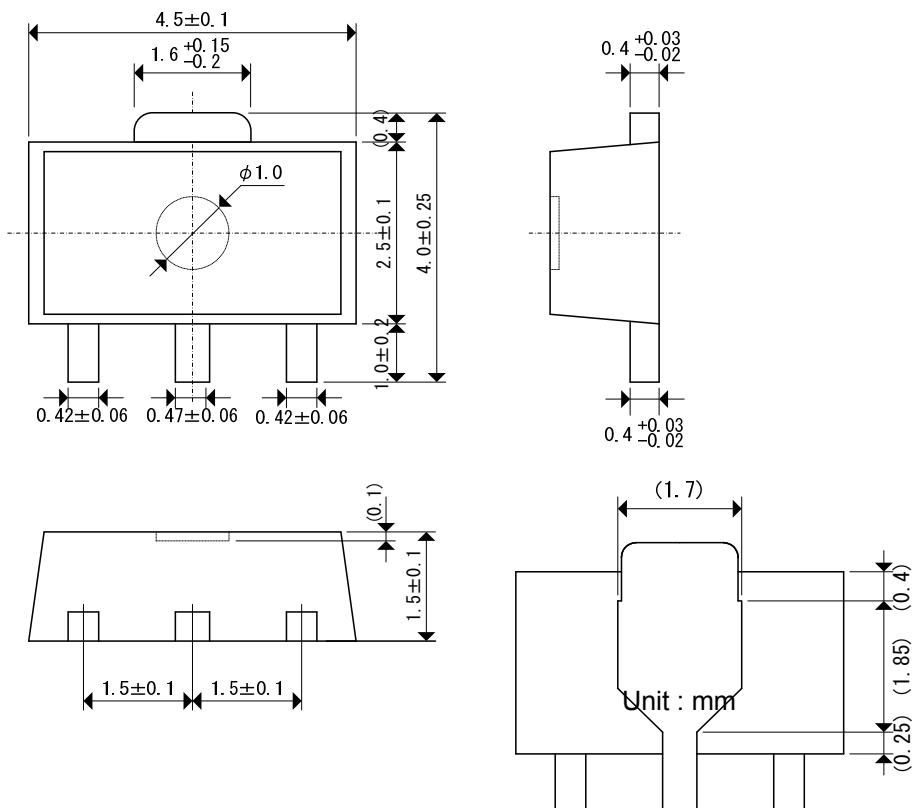

PACKAGING INFORMATION (Continued)

● SOT-223



Unit : mm

PACKAGING INFORMATION (Continued)

● USP-6B



Unit : mm

● USP-6B Recommended Pattern Layout

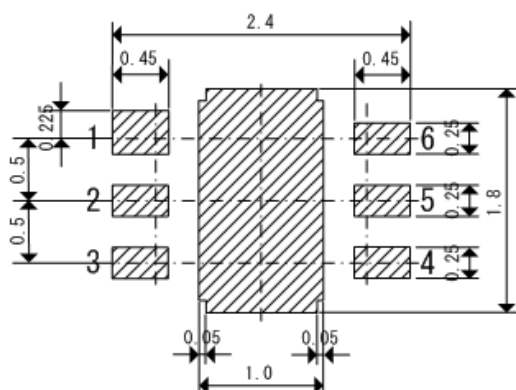

● USP-6B Recommended Metal Mask Design

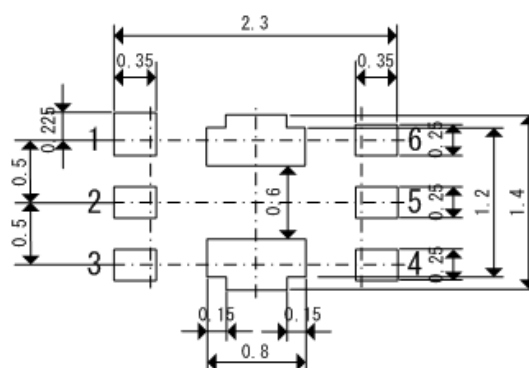

MARKING RULE

● SOT-23, SOT-89, SOT-223



SOT-23
(TOP VIEW)



SOT-89
(TOP VIEW)



SOT-223
(TOP VIEW)

① represents product series

| MARK | PRODUCT SERIES |
|------|----------------|
| 2 | XC6202Pxxxxx |

② represents output voltage range

| MARK | VOLTAGE (V) | PRODUCT SERIES |
|------|-------------|----------------|
| 4 | 0.1 ~ 3.0 | XC6202Pxxxxx |
| 5 | 3.1 ~ 6.0 | |
| 6 | 6.1 ~ 9.0 | |
| 7 | 9.1 ~ 12.0 | |
| 8 | 12.1 ~ 15.0 | |
| 9 | 15.1 ~ 18.0 | |

③ represents output voltage

| MARK | VOLTAGE (V) | | | | | | MARK | VOLTAGE (V) | | | | | |
|------|-------------|-----|-----|------|------|------|------|-------------|-----|-----|------|------|------|
| 0 | — | 3.1 | 6.1 | 9.1 | 12.1 | 15.1 | F | — | 4.6 | 7.6 | 10.6 | 13.6 | 16.6 |
| 1 | — | 3.2 | 6.2 | 9.2 | 12.2 | 15.2 | H | — | 4.7 | 7.7 | 10.7 | 13.7 | 16.7 |
| 2 | — | 3.3 | 6.3 | 9.3 | 12.3 | 15.3 | K | 1.8 | 4.8 | 7.8 | 10.8 | 13.8 | 16.8 |
| 3 | — | 3.4 | 6.4 | 9.4 | 12.4 | 15.4 | L | 1.9 | 4.9 | 7.9 | 10.9 | 13.9 | 16.9 |
| 4 | — | 3.5 | 6.5 | 9.5 | 12.5 | 15.5 | M | 2.0 | 5.0 | 8.0 | 11.0 | 14.0 | 17.0 |
| 5 | — | 3.6 | 6.6 | 9.6 | 12.6 | 15.6 | N | 2.1 | 5.1 | 8.1 | 11.1 | 14.1 | 17.1 |
| 6 | — | 3.7 | 6.7 | 9.7 | 12.7 | 15.7 | P | 2.2 | 5.2 | 8.2 | 11.2 | 14.2 | 17.2 |
| 7 | — | 3.8 | 6.8 | 9.8 | 12.8 | 15.8 | R | 2.3 | 5.3 | 8.3 | 11.3 | 14.3 | 17.3 |
| 8 | — | 3.9 | 6.9 | 9.9 | 12.9 | 15.9 | S | 2.4 | 5.4 | 8.4 | 11.4 | 14.4 | 17.4 |
| 9 | — | 4.0 | 7.0 | 10.0 | 13.0 | 16.0 | T | 2.5 | 5.5 | 8.5 | 11.5 | 14.5 | 17.5 |
| A | — | 4.1 | 7.1 | 10.1 | 13.1 | 16.1 | U | 2.6 | 5.6 | 8.6 | 11.6 | 14.6 | 17.6 |
| B | — | 4.2 | 7.2 | 10.2 | 13.2 | 16.2 | V | 2.7 | 5.7 | 8.7 | 11.7 | 14.7 | 17.7 |
| C | — | 4.3 | 7.3 | 10.3 | 13.3 | 16.3 | X | 2.8 | 5.8 | 8.8 | 11.8 | 14.8 | 17.8 |
| D | — | 4.4 | 7.4 | 10.4 | 13.4 | 16.4 | Y | 2.9 | 5.9 | 8.9 | 11.9 | 14.9 | 17.9 |
| E | — | 4.5 | 7.5 | 10.5 | 13.5 | 16.5 | Z | 3.0 | 6.0 | 9.0 | 12.0 | 15.0 | 18.0 |

④ represents production lot number

0 to 9, A to Z reversed character 0 to 9, A to Z repeated. (G, I, J, O, Q, W excluded)

■ MARKING RULE (Continued)

● USP-6B



USP-6B
(TOP VIEW)

①② represents product series

| MARK | | PRODUCT SERIES |
|------|---|----------------|
| ② | ② | |
| 0 | 2 | XC6202PxxxDx |

③ represents type of regulator

| MARK | PRODUCT SERIES |
|------|----------------|
| P | XC6202Pxxxxx |

④ represents integer of the output voltage

| MARK | VOLTAGE (V) | PRODUCT SERIES | MARK | VOLTAGE (V) | PRODUCT SERIES |
|------|-------------|----------------|------|-------------|----------------|
| 1 | 1.x | XC6202P1xxDx | A | 10.x | XC6202PAxxDx |
| 2 | 2.x | XC6202P2xxDx | B | 11.x | XC6202PBxxDx |
| 3 | 3.x | XC6202P3xxDx | C | 12.x | XC6202PCxxDx |
| 4 | 4.x | XC6202P4xxDx | D | 13.x | XC6202PDxxDx |
| 5 | 5.x | XC6202P5xxDx | E | 14.x | XC6202PExxDx |
| 6 | 6.x | XC6202P6xxDx | F | 15.x | XC6202PFxxDx |
| 7 | 7.x | XC6202P7xxDx | G | 16.x | XC6202PGxxDx |
| 8 | 8.x | XC6202P8xxDx | H | 17.x | XC6202PHxxDx |
| 9 | 9.x | XC6202P9xxDx | J | 18.x | XC6202PJxxDx |

⑤ represents decimal number of output voltage

| MARK | VOLTAGE (V) | PRODUCT SERIES |
|------|-------------|----------------|
| 3 | X.3 | XC6202Px3xDx |
| 0 | X.0 | XC6202Px0xDx |

⑥ represents production lot number

0 to 9, A to Z repeated (G, I, J, O, Q, W excluded)



Note: No character inversion used.

1. The product and product specifications contained herein are subject to change without notice to improve performance characteristics. Consult us, or our representatives before use, to confirm that the information in this datasheet is up to date.
2. The information in this datasheet is intended to illustrate the operation and characteristics of our products. We neither make warranties or representations with respect to the accuracy or completeness of the information contained in this datasheet nor grant any license to any intellectual property rights of ours or any third party concerning with the information in this datasheet.
3. Applicable export control laws and regulations should be complied and the procedures required by such laws and regulations should also be followed, when the product or any information contained in this datasheet is exported.
4. The product is neither intended nor warranted for use in equipment of systems which require extremely high levels of quality and/or reliability and/or a malfunction or failure which may cause loss of human life, bodily injury, serious property damage including but not limited to devices or equipment used in 1) nuclear facilities, 2) aerospace industry, 3) medical facilities, 4) automobile industry and other transportation industry and 5) safety devices and safety equipment to control combustions and explosions. Do not use the product for the above use unless agreed by us in writing in advance.
5. Although we make continuous efforts to improve the quality and reliability of our products; nevertheless Semiconductors are likely to fail with a certain probability. So in order to prevent personal injury and/or property damage resulting from such failure, customers are required to incorporate adequate safety measures in their designs, such as system fail safes, redundancy and fire prevention features.
6. Our products are not designed to be Radiation-resistant.
7. Please use the product listed in this datasheet within the specified ranges.
8. We assume no responsibility for damage or loss due to abnormal use.
9. All rights reserved. No part of this datasheet may be copied or reproduced unless agreed by Torex Semiconductor Ltd in writing in advance.

TOREX SEMICONDUCTOR LTD.

Looking for pricing, stock, or lifecycle information?

Click below to explore more details on WIN SOURCE:

-  [View XC6202P432PRN on WIN SOURCE](#)
-  [Torex Semiconductor Ltd Information](#)

Optimize Your Supply Chain with WIN SOURCE Solutions

-  Global Sourcing Solution
-  Obsolete Management
-  Cost Control Management
-  Shortage Management
-  Alternative Solution
-  Excess Inventory Management