



**THE DATASHEET OF  
XC6206P212PRN**



## Low ESR Cap. Compatible Positive Voltage Regulators

### ■ GENERAL DESCRIPTION

The XC6206 series are highly precise, low power consumption, 3 terminal, positive voltage regulators manufactured using CMOS and laser trimming technologies. The series provides large currents with a significantly small dropout voltage.

The XC6206 consists of a current limiter circuit, a driver transistor, a precision reference voltage and an error correction circuit. The series is compatible with low ESR ceramic capacitors. The current limiter's foldback circuit operates as a short circuit protection as well as the output current limiter for the output pin.

Output voltages are internally by laser trimming technologies. It is selectable in 0.1V increments within a range of 1.2V to 5.0V. SOT-23, SOT-89 and USP-6B packages are available.

### ■ APPLICATIONS

- Smart phones / Mobile phones
- Portable game consoles
- Digital still cameras / Camcorders
- Digital audio equipments
- Reference voltage sources
- Multi-function power supplies

### ■ FEATURES

<b>Maximum Output Current</b>	: 200mA (3.0V type)
<b>Dropout Voltage</b>	: 250mV @ 100mA (3.0V type)
<b>Maximum Operating Voltage</b>	: 6.0V
<b>Output Voltage Range</b>	: 1.2V ~ 5.0V (0.1V increments)
<b>Highly Accurate</b>	: $\pm 2\%$ @ $V_{OUT} \geq 1.5V$ $\pm 30mV$ @ $V_{OUT} < 1.5V$ $(\pm 1\% @ V_{OUT} \geq 2.0V)$
<b>Low Power Consumption</b>	: 1.0 $\mu$ A (TYP.)
<b>Low ESR Capacitor</b>	: Ceramic capacitor compatible
<b>Protection</b>	: Current Limit Circuit Built-in
<b>Operating Ambient Temperature</b>	: -40°C ~ +85°C
<b>Packages</b>	: SOT-23 SOT-89 USP-6B
<b>Environmentally Friendly</b>	: EU RoHS Compliant, Pb Free

### ■ TYPICAL APPLICATION CIRCUIT

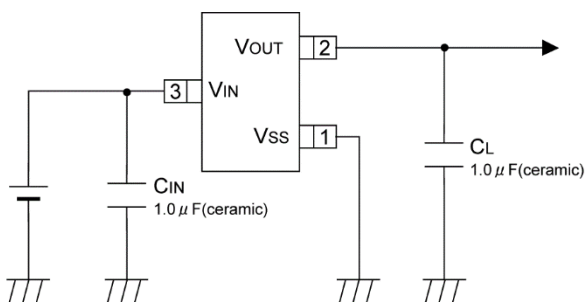

### ■ TYPICAL PERFORMANCE CHARACTERISTICS

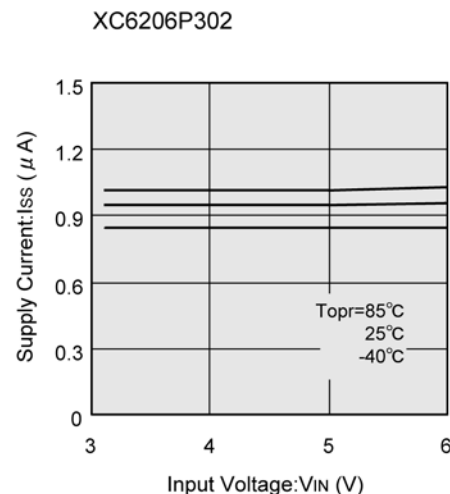

## ■ BLOCK DIAGRAM

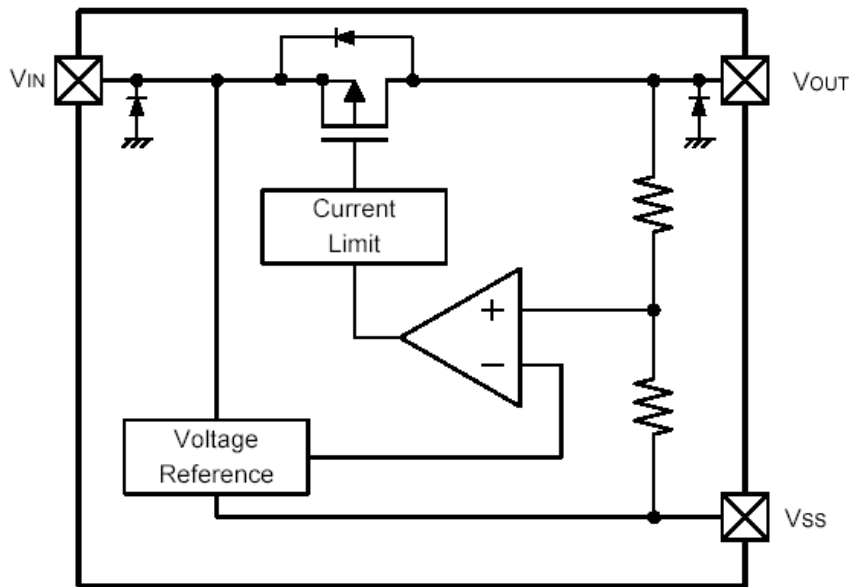

\*Diodes inside the circuit are an ESD protection diode and a parasitic diode.

## ■ PRODUCT CLASSIFICATION

### ● Ordering Information

XC6206P①②③④⑤-⑥<sup>(\*)</sup>

DESIGNATOR	ITEM	SYMBOL	DESCRIPTION
①②	Output Voltage	12~50	e.g. V <sub>OUT</sub> : 3.0V → ①=3, ②=0
③	Accuracy	2	±2% (V <sub>OUT</sub> ≥ 1.5V), ±30mV (V <sub>OUT</sub> < 1.5V)
		1	±1% (V <sub>OUT</sub> ≥ 2.0V)
④⑤-⑥	Packages (Order Unit)	MR	SOT-23 (3,000pcs/Reel)
		MR-G	SOT-23 (3,000pcs/Reel)
		PR	SOT-89 (1,000pcs/Reel)
		PR-G	SOT-89 (1,000pcs/Reel)
		DR	USP-6B (3,000pcs/Reel)
		DR-G	USP-6B (3,000pcs/Reel)

<sup>(\*)</sup> The "-G" suffix denotes Halogen and Antimony free as well as being fully EU RoHS compliant.

## ■ PIN CONFIGURATION

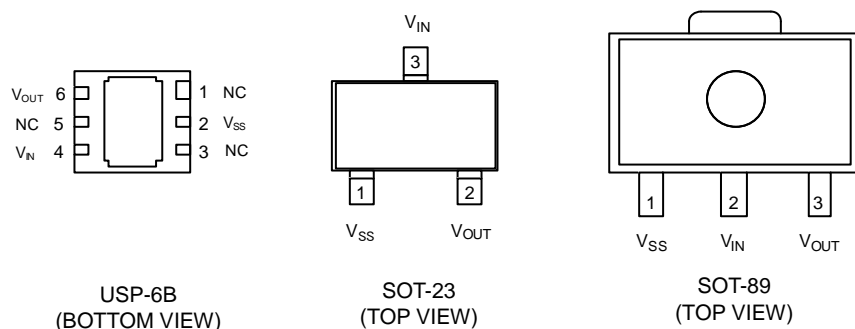

\*The dissipation pad for the USP-6B package should be solder-plated in recommended mount pattern and metal masking so as to enhance mounting strength and heat release.  
If the pad needs to be connected to other pins, it should be connected to the pin number 4 (V<sub>IN</sub>).

## ■ PIN ASSIGNMENT

PIN NUMBER			PIN NAME	FUNCTIONS
SOT-23	SOT-89	USP-6B		
1	1	2	V <sub>SS</sub>	Ground
3	2	4	V <sub>IN</sub>	Power Input
2	3	6	V <sub>OUT</sub>	Output
-	-	1, 3, 5	NC	No Connection

## ■ ABSOLUTE MAXIMUM RATINGS

PARAMETER			SYMBOL	RATINGS	Ta=25°C UNITS
Input Voltage			V <sub>IN</sub>	-0.3~+7.0	V
Output Current			I <sub>OUT</sub>	500 <sup>(*)1</sup>	mA
Output Voltage			V <sub>OUT</sub>	-0.3 ~ V <sub>IN</sub> + 0.3	V
Power Dissipation	SOT-23	Pd	250	1000(40mm x 40mm Standard board) <sup>(*)2</sup>	mW
			500(40mm x 40mm Standard board) <sup>(*)2</sup>		
	SOT-89		500		
			1000(40mm x 40mm Standard board) <sup>(*)2</sup>		
USP-6B		120	1000(40mm x 40mm Standard board) <sup>(*)2</sup>		
Operating Ambient Temperature			Topr	- 40 ~ + 85	°C
Storage Temperature			Tstg	- 55 ~ + 125	°C

(\*)1 I<sub>OUT</sub> ≤ Pd / (V<sub>IN</sub>-V<sub>OUT</sub>)

(\*)2 The power dissipation figure shown is PCB mounted and is for reference only.  
The mounting condition is please refer to PACKAGING INFORMATION.

## ELECTRICAL CHARACTERISTICS

Ta=25°C

PARAMETER	SYMBOL	CONDITIONS	MIN.	TYP.	MAX.	UNITS	CIRCUIT	
Output Voltage (Standard) <sup>(*2)</sup>	V <sub>OUT(E)</sub> <sup>(*3)</sup>	I <sub>OUT</sub> =30mA	V <sub>OUT(T)</sub> <1.5V	-0.03	V <sub>OUT(T)</sub> <sup>(*4)</sup>	+0.03	V	②
Output Voltage (High Accuracy) <sup>(*2)</sup>			V <sub>OUT(T)</sub> ≥1.5V	×0.98		×1.02		
			V <sub>OUT(T)</sub> ≥2.0V	×0.99		×1.01		
Supply Current	I <sub>DD</sub>		-	1.0	3.0	μA	①	
Load Regulation	ΔV <sub>OUT</sub>	V <sub>OUT(T)</sub> ≤1.8V, 1mA≤I <sub>OUT</sub> ≤50mA	-	-	E-1 <sup>(*5)</sup>	mV	②	
		V <sub>OUT(T)</sub> >1.8V, 1mA≤I <sub>OUT</sub> ≤100mA						
Dropout Voltage 1	V <sub>dif1</sub> <sup>(*6)</sup>	I <sub>OUT</sub> =30mA	-	E-2 <sup>(*5)</sup>		mV	②	
Dropout Voltage 2	V <sub>dif2</sub> <sup>(*6)</sup>	V <sub>OUT(T)</sub> ≤1.8V, I <sub>OUT</sub> =60mA V <sub>OUT(T)</sub> >1.8V, I <sub>OUT</sub> =100mA	-	E-3 <sup>(*5)</sup>				
Line Regulation	ΔV <sub>OUT</sub> / (ΔV <sub>IN</sub> · V <sub>OUT</sub> )	V <sub>OUT(T)</sub> <4.5V, V <sub>OUT(T)</sub> +1.0V≤V <sub>IN</sub> ≤6.0V, I <sub>OUT</sub> =30mA	-	0.05	0.25	%V	②	
		V <sub>OUT(T)</sub> ≥4.5V, 5.5V≤V <sub>IN</sub> ≤6.0V, I <sub>OUT</sub> =30mA						
Maximum Output Current	I <sub>OUTMAX</sub>	V <sub>OUT</sub> ≥V <sub>OUT(E)</sub> ×0.9	E-4 <sup>(*5)</sup>	-	-	mA	②	
Short Circuit Current	I <sub>SHORT</sub>	V <sub>OUT</sub> =V <sub>SS</sub>	-	E-5 <sup>(*5)</sup>	-	mA	②	
Input Voltage	V <sub>IN</sub>		1.8	-	6.0	V	②	
Output Voltage Temperature Characteristics	ΔV <sub>OUT</sub> / (ΔT <sub>opr</sub> · V <sub>OUT</sub> )	I <sub>OUT</sub> =30mA, -40°C≤T <sub>opr</sub> ≤85°C	-	±100	-	ppm/°C	②	

\*1: Unless otherwise stated, V<sub>IN</sub> = V<sub>OUT(T)</sub> + 1.0V

\*2: (Standard): ±2% (1.5V ≤ V<sub>OUT(T)</sub>), ±0.03V (1.5V > V<sub>OUT(T)</sub>)  
(High Accuracy): ±1% (2.0V ≤ V<sub>OUT(T)</sub>)

\*3: V<sub>OUT(E)</sub>: Effective output voltage.

\*4: V<sub>OUT(T)</sub>: Nominal voltage

\*5: For E-1, E-2, E-3, E-4, E-5, Please refer to Electrical Characteristics Chart.

\*6: V<sub>dif</sub> = V<sub>IN1</sub> - V<sub>OUT1</sub>

V<sub>OUT1</sub>: A voltage equal to 98% of the output voltage whenever an amply stabilized {V<sub>OUT(T)</sub> + 1.0V} is input with each I<sub>OUT</sub>.

V<sub>IN1</sub>: The input voltage when V<sub>OUT1</sub> appears as input voltage is gradually decreased.

\*7: The low ESR capacitors use that is more than 1.0μF as C<sub>L</sub> is possible.

**■ ELECTRICAL CHARACTERISTICS (Continued)**

● Electrical Characteristics Chart

NOMINAL VOLTAGE	E-1	E-2		E-3		E-4	E-5
	LOAD REGULATION	DROPOUT VOLTAGE1		DROPOUT VOLTAGE2		MAX. OUTPUT CURRENT	SHORT CURRENT
	$\Delta V_{OUT}$ (mV)	$V_{dif1}$ (mV)		$V_{dif2}$ (mV)		$I_{OUTMAX}$ (mA)	$I_{SHORT}$ (mA)
$V_{OUT(T)}$	MAX.	TYP.	MAX.	TYP.	MAX.	MIN.	TYP.
1.2	40	460	760	700	960	60	180
1.3		400	650				
1.4		350	590				
1.5	45	300	510	580	860	80	155
1.6		250	450	450	810		
1.7		200	410				
1.8		150	390				
1.9	50	100	370	350	780	120	130
2.0							
2.1							
2.2							
2.3							
2.4	55	100	370	350	710	150	100
2.5							
2.6							
2.7							
2.8							
2.9							
3.0	60	75	350	250	680	200	100
3.1							
3.2							
3.3							
3.4							
3.5							
3.6							
3.7	65	75	320	200	630	250	100
3.8							
3.9							
4.0							
4.1	70	60	320	200	630	250	100
4.2							
4.3							
4.4							
4.5							
4.6	75	60	320	200	630	250	100
4.7							
4.8							
4.9							
5.0	80	50	290	175	600		

## TEST CIRCUITS

Circuit ①

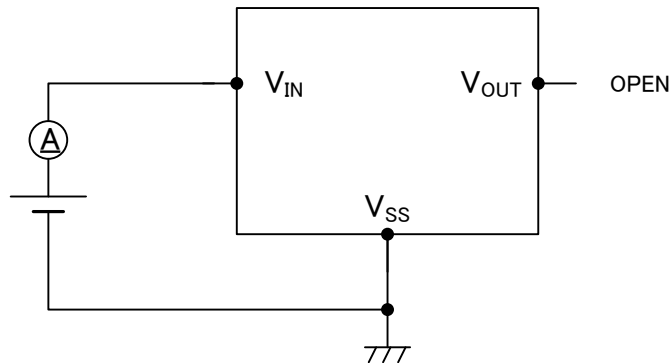

Circuit ②

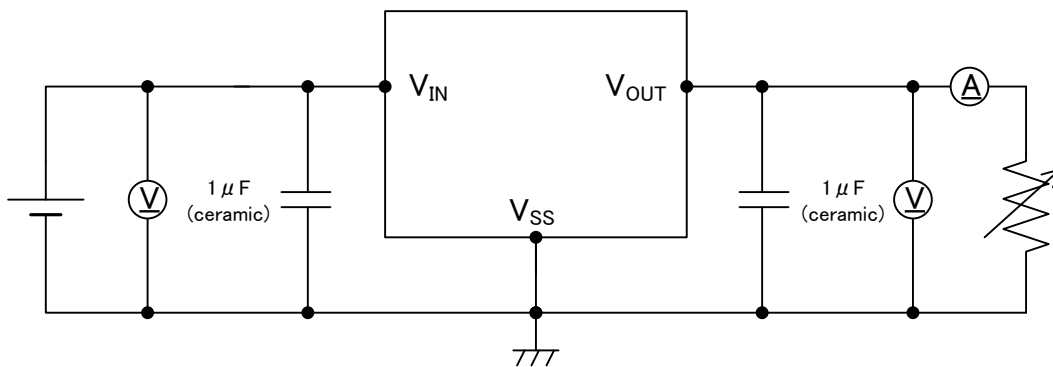

## NOTES ON USE

1. For temporary, transitional voltage drop or voltage rising phenomenon, the IC is liable to malfunction should the ratings be exceeded.
2. Where wiring impedance is high, operations may become unstable due to noise and/or phase lag depending on output current. Please strengthen  $V_{IN}$  and  $V_{SS}$  wiring in particular
3. Please wire the input capacitor ( $C_{IN}$ ) and the output capacitor ( $C_L$ ) as close to the IC as possible.
4. Capacitances of these capacitors ( $C_{IN}$ ,  $C_L$ ) are decreased by the influences of bias voltage and ambient temperature. Care shall be taken for capacitor selection to ensure stability of phase compensation from the point of ESR influence.
5. When it is used in a quite small input / output dropout voltage, output may go into unstable operation. Please test it thoroughly before using it in production.
6. Torex places an importance on improving our products and their reliability. We request that users incorporate fail-safe designs and post-aging protection treatment when using Torex products in their systems.

## TYPICAL PERFORMANCE CHARACTERISTICS

### (1) Output Voltage vs. Output Current

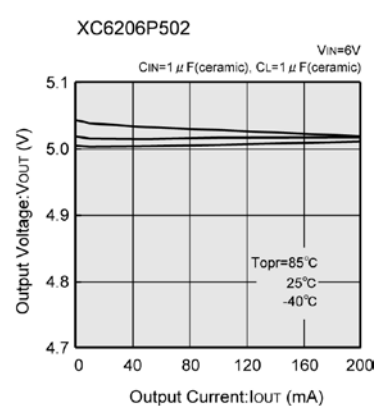
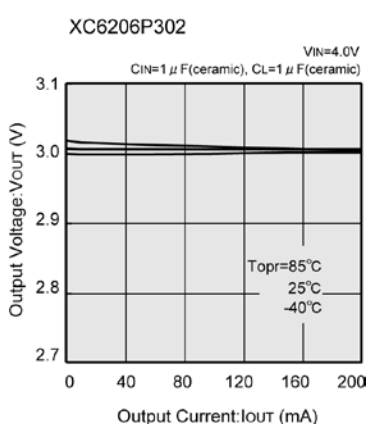
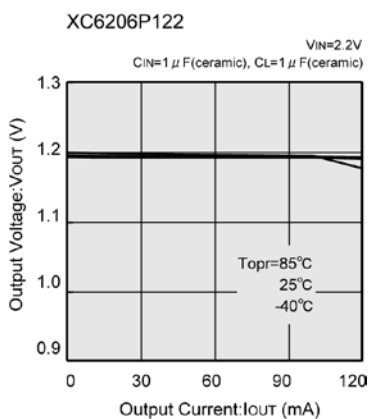

### (2) Current Limit

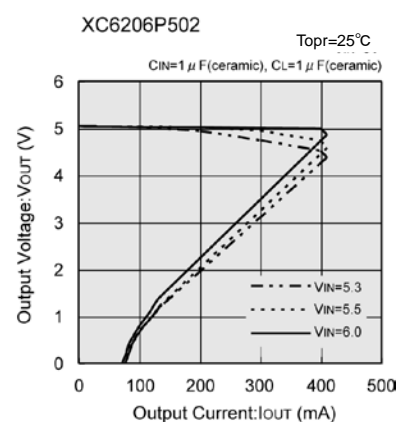
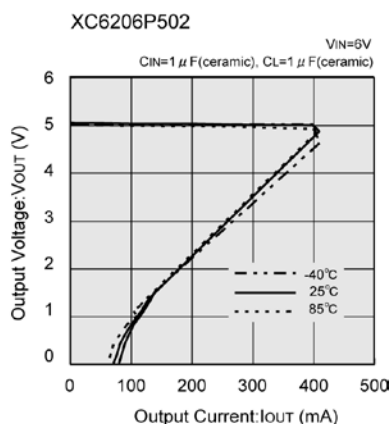
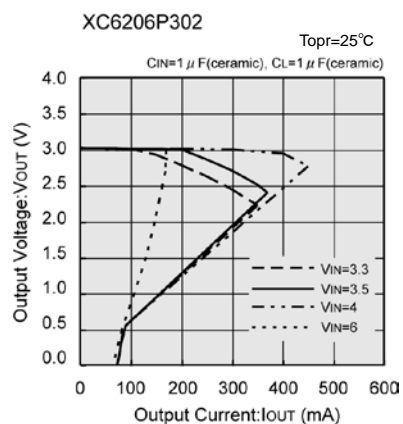
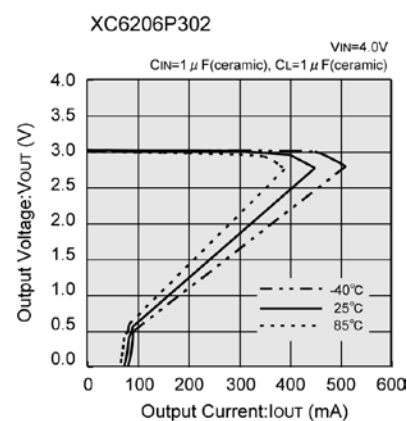
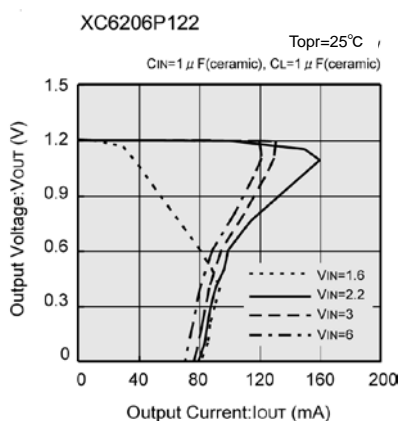
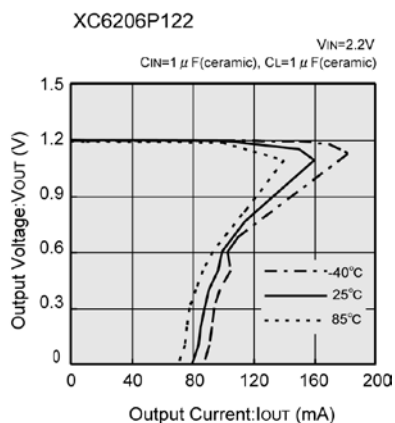

# XC6206 Series

## TYPICAL PERFORMANCE CHARACTERISTICS (Continued)

### (3) Output Voltage vs. Input Voltage

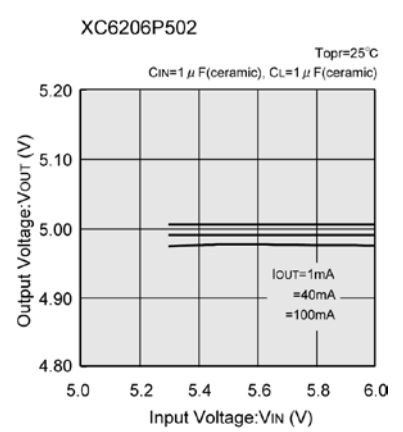
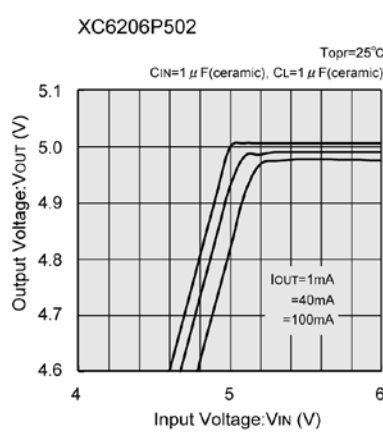
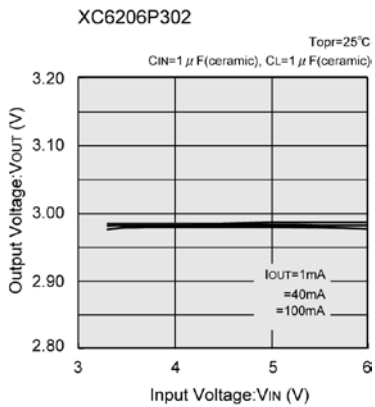
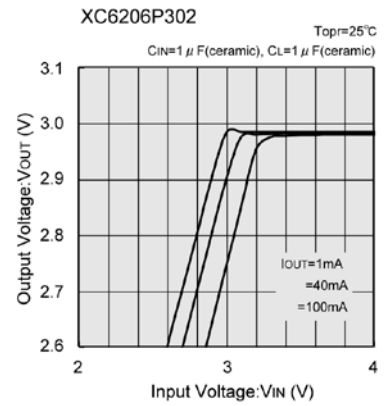
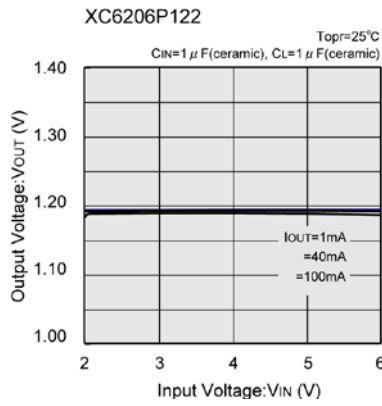
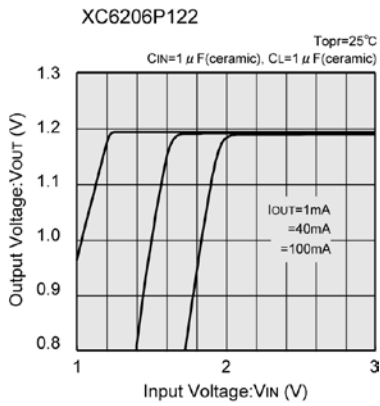

### (4) Dropout Voltage vs. Output Current

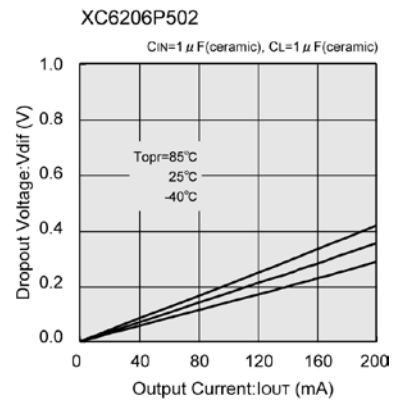
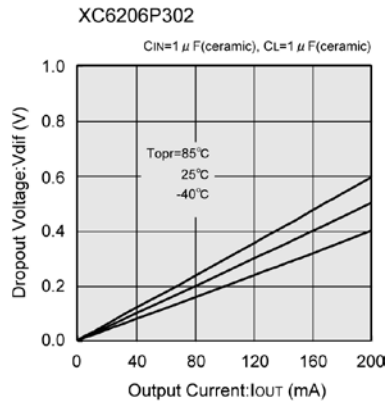
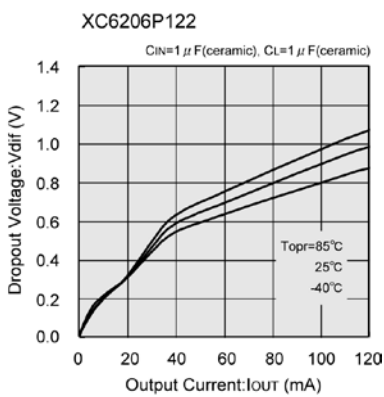

## ■ TYPICAL PERFORMANCE CHARACTERISTICS (Continued)

### (5) Supply Current vs. Input Voltage

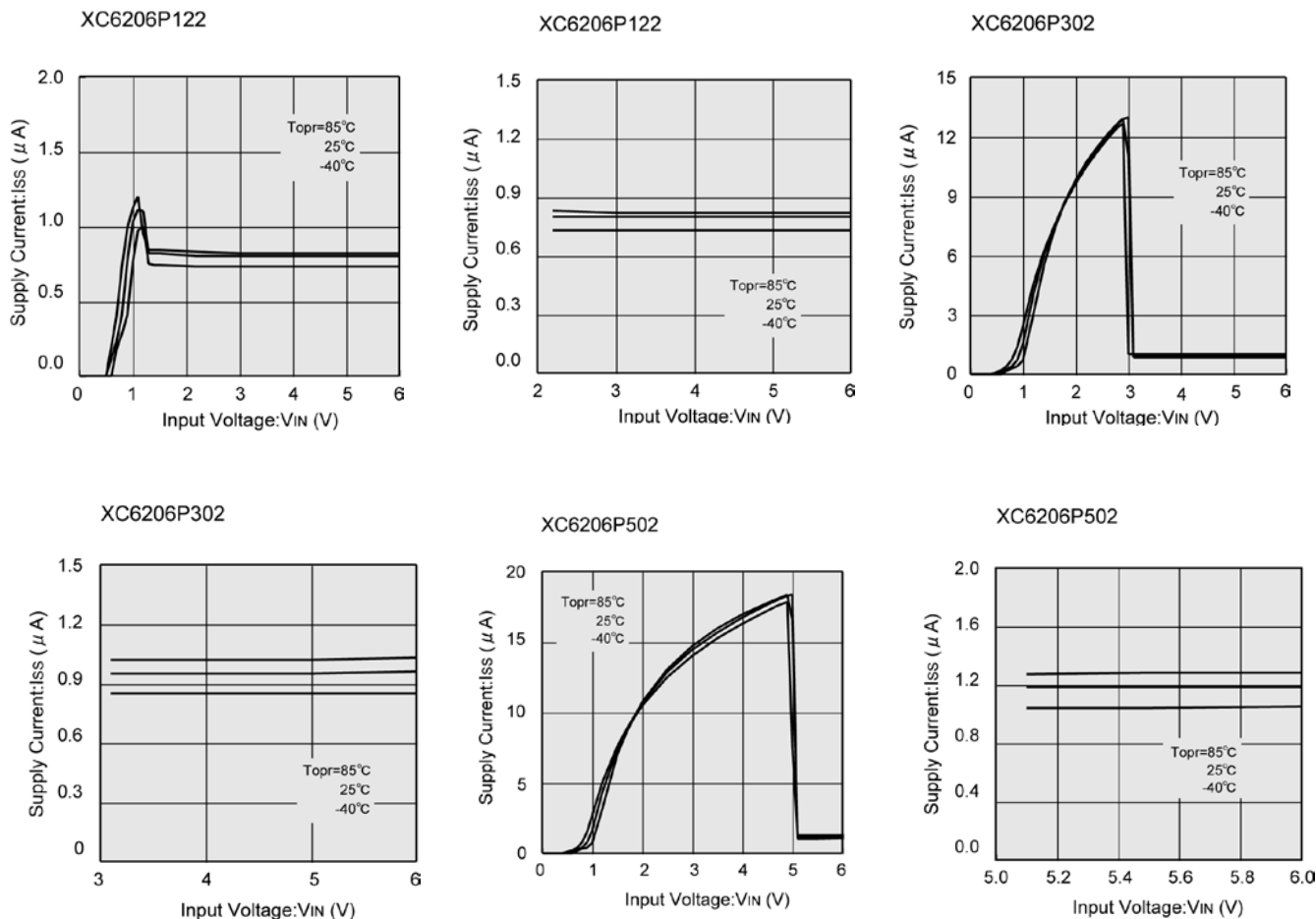

### (6) Output Voltage vs. Ambient Temperature

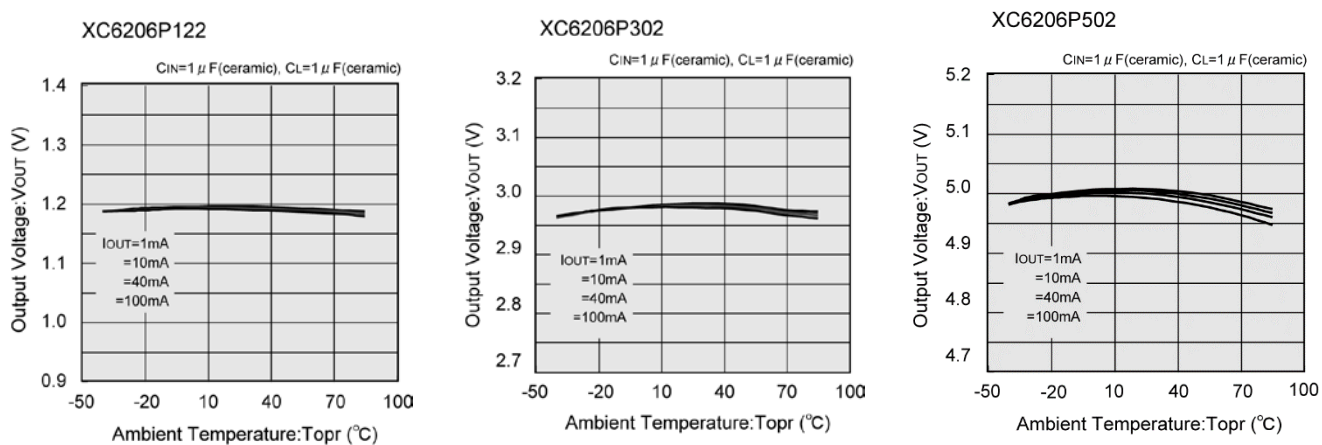

## TYPICAL PERFORMANCE CHARACTERISTICS (Continued)

### (7) Output Voltage vs. Ambient Temperature

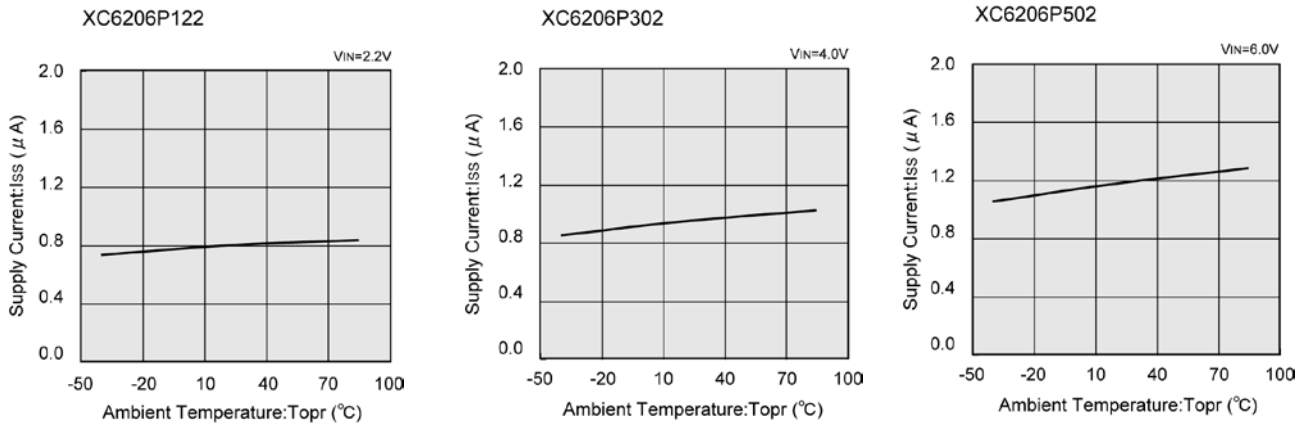

### (8) Input Transient Response 1

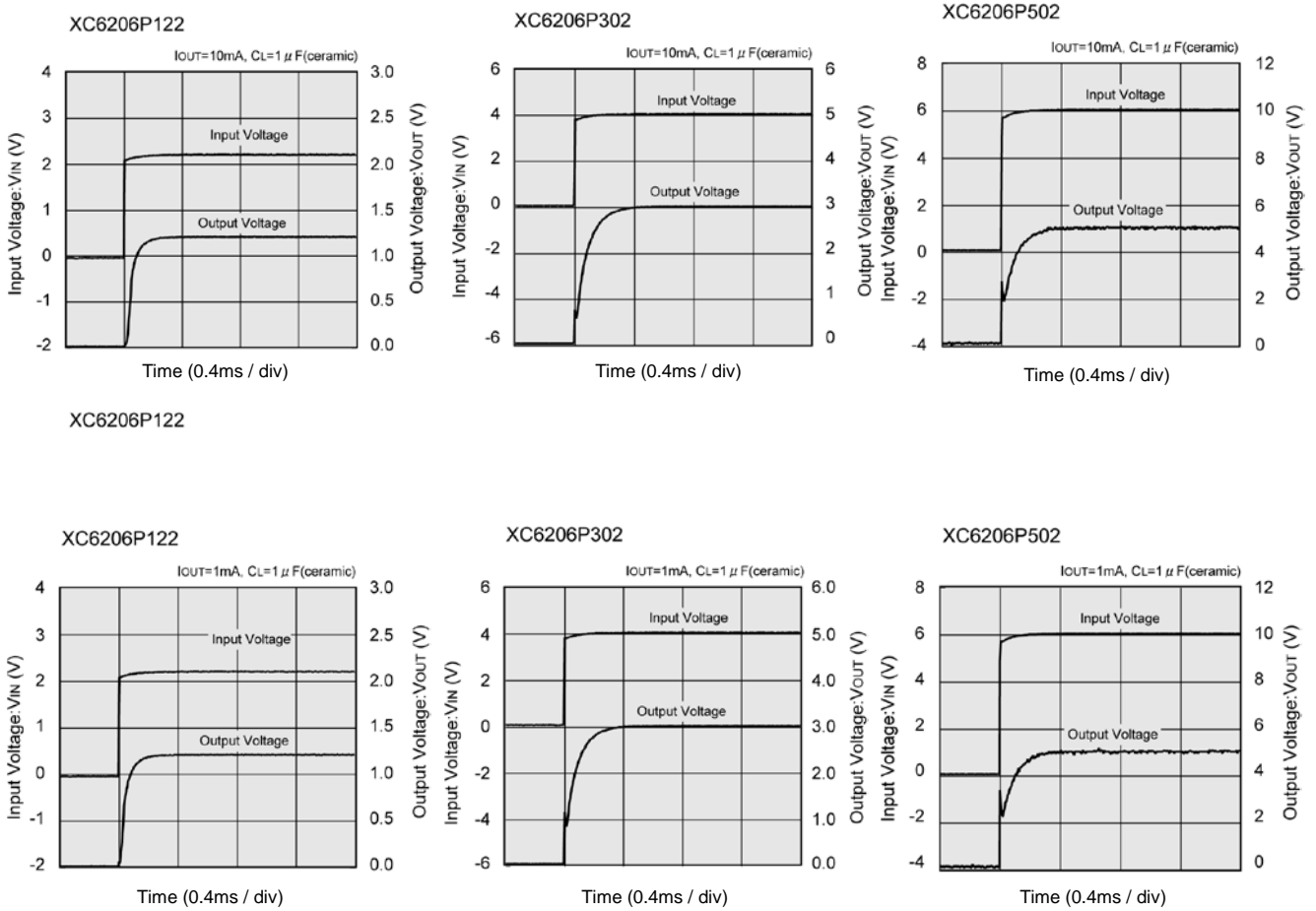

## ■ TYPICAL PERFORMANCE CHARACTERISTICS (Continued)

### (9) Input Transient Response 2

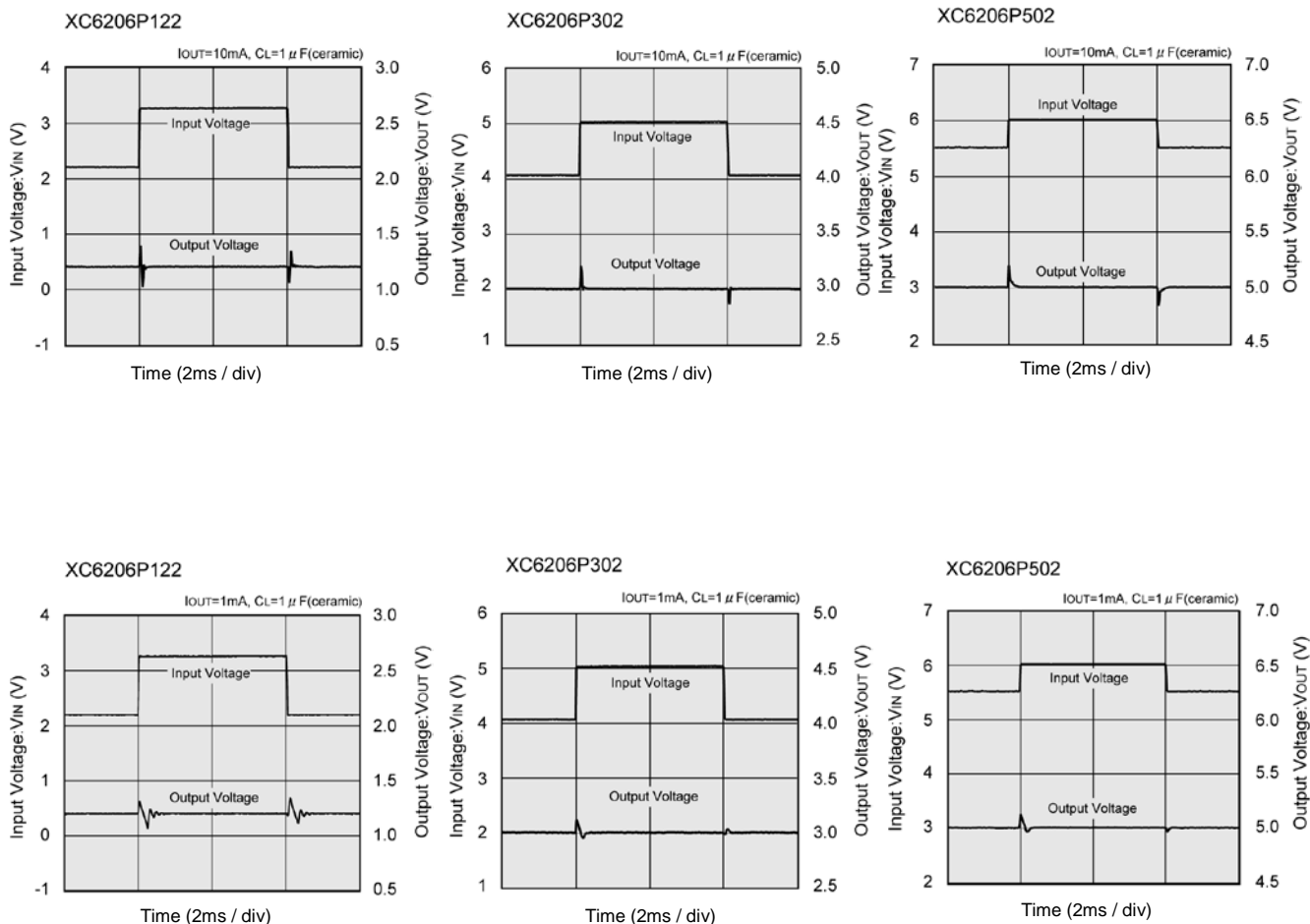

### (10) Load Transient Response

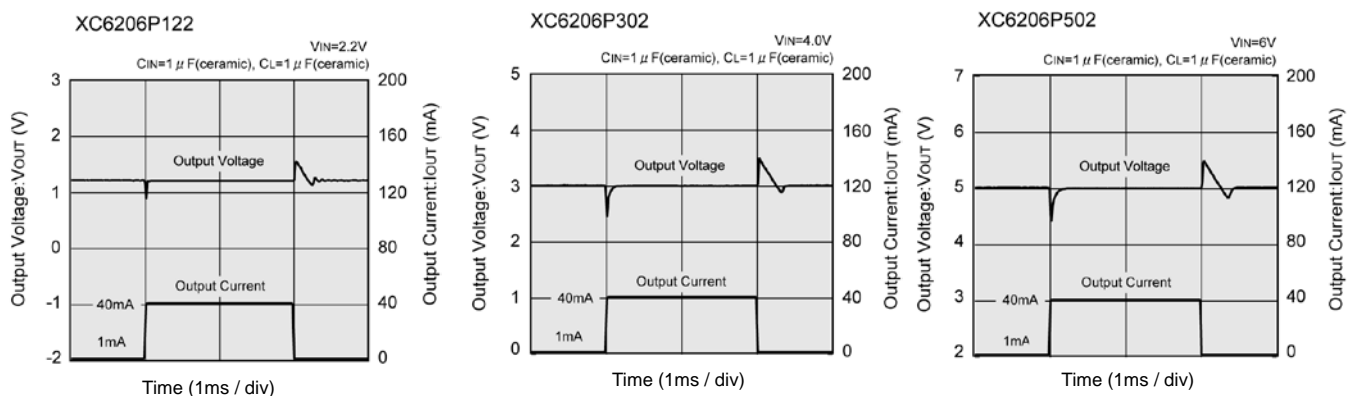

## TYPICAL PERFORMANCE CHARACTERISTICS (Continued)

### (11) Ripple Rejection Rate

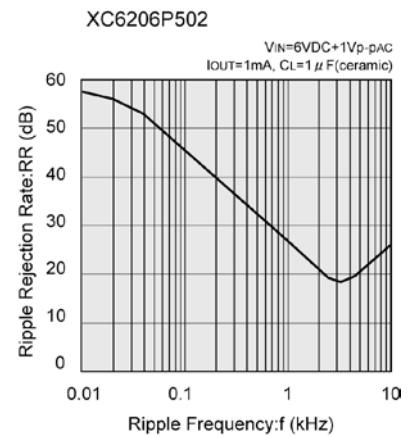
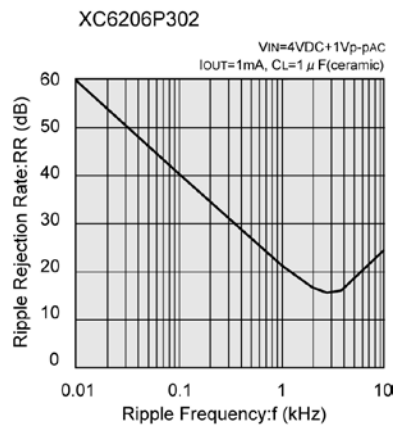
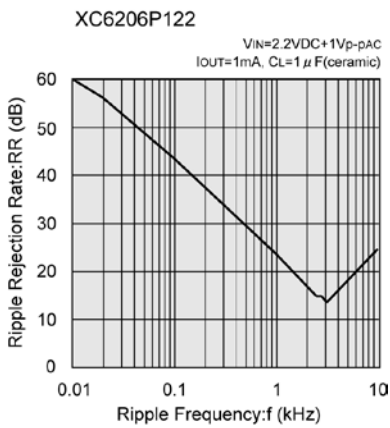
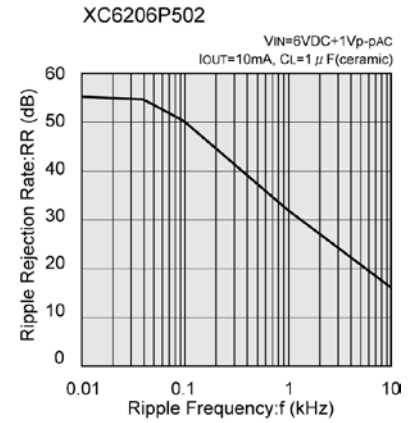
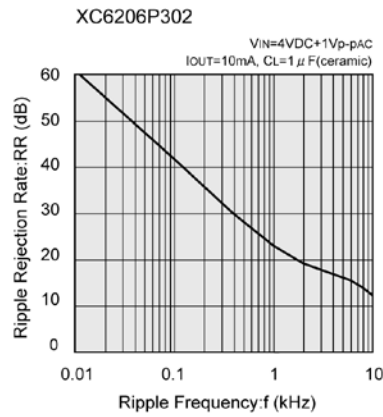
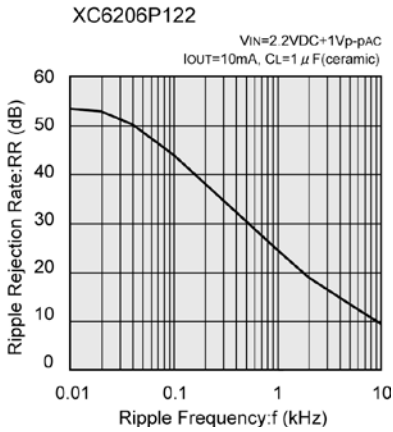

## ■ PACKAGING INFORMATION

For the latest package information go to, [www.torexsemi.com/technical-support/packages](http://www.torexsemi.com/technical-support/packages)

PACKAGE	OUTLIN / LAND PATTERN	THERMAL CHARACTERISTICS	
SOT-23	<a href="#">SOT-23 PKG</a>	Standard Board	<a href="#">SOT-23 Power Dissipation</a>
SOT-89	<a href="#">SOT-89 PKG</a>	Standard Board	<a href="#">SOT-89 Power Dissipation</a>
USP-6B	<a href="#">USP-6B PKG</a>	Standard Board	<a href="#">USP-6B Power Dissipation</a>

# XC6206 Series

## MARKING RULE

### ●SOT-23, SOT-89

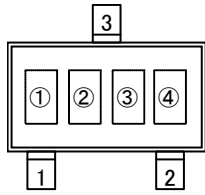

SOT-23  
(TOP VIEW)

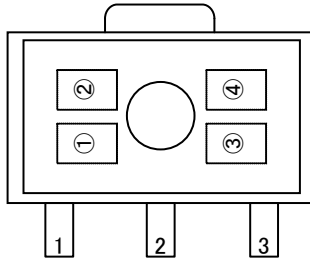

SOT-89  
(TOP VIEW)

① represents product number

MARK	PRODUCT SERIES
6	XC6206P*****

② represents 3 pins regulator

MARK		PRODUCT SERIES
VOLTAGE=0.1 ~ 3.0V	VOLTAGE=3.1 ~ 6.0V	
5	6	XC6206P*****

③ represents output voltage

MARK	VOLTAGE (V)			MARK	OUTPUT VOLTAGE (V)		
0	-	3.1	-	F	1.6	4.6	-
1	-	3.2	-	H	1.7	4.7	-
2	-	3.3	-	K	1.8	4.8	-
3	-	3.4	-	L	1.9	4.9	-
4	-	3.5	-	M	2.0	5.0	-
5	-	3.6	-	N	2.1	-	-
6	-	3.7	-	P	2.2	-	-
7	-	3.8	-	R	2.3	-	-
8	-	3.9	-	S	2.4	-	-
9	-	4.0	-	T	2.5	-	-
A	-	4.1	-	U	2.6	-	-
B	1.2	4.2	-	V	2.7	-	-
C	1.3	4.3	-	X	2.8	-	-
D	1.4	4.4	-	Y	2.9	-	-
E	1.5	4.5	-	Z	3.0	-	-

④ represents production lot number

0 to 9, A to Z repeated. (G, I, J, O, Q, W excluded)

### ●USP-6B

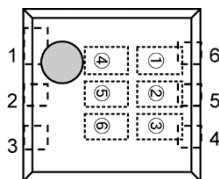

USP-6B  
(TOP VIEW)

①② represents product number

MARK		PRODUCT SERIES
①	②	
0	6	XC6206P***D*

③ represents 3 pins regulator

MARK	PRODUCT SERIES
P	XC6206P***D*

④⑤ represents output voltage

MARK		OUTPUT VOLTAGE(V)	PRODUCT SERIES
④	⑤		
3	3	3.3	XC6206P33*D*
5	0	5.0	XC6206P50*D*

⑥ represents production lot number

0 to 9, A to Z repeated. (G, I, J, O, Q, W excluded)

1. The product and product specifications contained herein are subject to change without notice to improve performance characteristics. Consult us, or our representatives before use, to confirm that the information in this datasheet is up to date.
2. The information in this datasheet is intended to illustrate the operation and characteristics of our products. We neither make warranties or representations with respect to the accuracy or completeness of the information contained in this datasheet nor grant any license to any intellectual property rights of ours or any third party concerning with the information in this datasheet.
3. Applicable export control laws and regulations should be complied and the procedures required by such laws and regulations should also be followed, when the product or any information contained in this datasheet is exported.
4. The product is neither intended nor warranted for use in equipment of systems which require extremely high levels of quality and/or reliability and/or a malfunction or failure which may cause loss of human life, bodily injury, serious property damage including but not limited to devices or equipment used in 1) nuclear facilities, 2) aerospace industry, 3) medical facilities, 4) automobile industry and other transportation industry and 5) safety devices and safety equipment to control combustions and explosions. Do not use the product for the above use unless agreed by us in writing in advance.
5. Although we make continuous efforts to improve the quality and reliability of our products; nevertheless Semiconductors are likely to fail with a certain probability. So in order to prevent personal injury and/or property damage resulting from such failure, customers are required to incorporate adequate safety measures in their designs, such as system fail safes, redundancy and fire prevention features.
6. Our products are not designed to be Radiation-resistant.
7. Please use the product listed in this datasheet within the specified ranges.
8. We assume no responsibility for damage or loss due to abnormal use.
9. All rights reserved. No part of this datasheet may be copied or reproduced unless agreed by Torex Semiconductor Ltd in writing in advance.

TOREX SEMICONDUCTOR LTD.

## Looking for pricing, stock, or lifecycle information?

Click below to explore more details on WIN SOURCE:

- ⊖ [View XC6206P212PRN on WIN SOURCE](#)
- ⊖ [Torex Semiconductor Ltd Information](#)

## Optimize Your Supply Chain with WIN SOURCE Solutions

- ✓ Global Sourcing Solution
- ✓ Obsolete Management
- ✓ Cost Control Management
- ✓ Shortage Management
- ✓ Alternative Solution
- ✓ Excess Inventory Management